

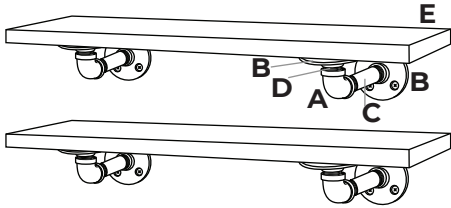



**NEED HELP OR ADVICE ON PUTTING THIS KIT TOGETHER? MISSING PIECES?  
EMAIL US AT [HELP@PIPE-DECOR.COM](mailto:HELP@PIPE-DECOR.COM) FOR ANY QUESTIONS**

## 24" SHELF SET

(2) 24" Shelves with (2) L-Shaped Brackets







- F  (X 16)  
G  (X 16)  
H  (X 16)

PART	DESCRIPTION - FOR 24" SHELVES	QTY
A	1/2" 90° ELBOW	4
B	1/2" FLANGES	8
C	1/2" X 4" PIPE	4
D	1/2" CLOSE PIPE	4
E	24" WOOD SHELF	2
F	WOOD SCREWS	16
G	1-3/4" SCREWS	16
H	WALL ANCHORS	16

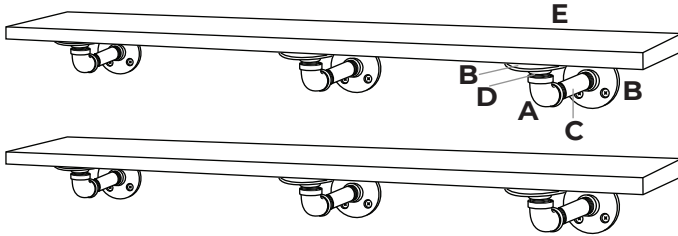
## 36" SHELF SET

(2) 36" Shelves with (3) L-Shaped Brackets







- F  (X 24)  
G  (X 24)  
H  (X 24)

PART	DESCRIPTION - FOR 36" SHELVES	QTY
A	1/2" 90° ELBOW	6
B	1/2" FLANGES	12
C	1/2" X 4" PIPE	6
D	1/2" CLOSE PIPE	6
E	36" WOOD SHELF	2
F	WOOD SCREWS	24
G	1-3/4" SCREWS	24
H	WALL ANCHORS	24

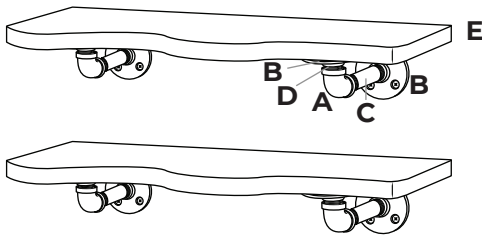
## 24" LIVE EDGE SHELF SET

(2) 24" Shelves with (2) L-Shaped Brackets







- F  (X 16)  
G  (X 16)  
H  (X 16)

PART	DESCRIPTION - FOR 24" LIVE EDGE SHELVES	QTY
A	1/2" 90° ELBOW	4
B	1/2" FLANGES	8
C	1/2" X 4" PIPE	4
D	1/2" CLOSE PIPE	4
E	24" LIVE EDGE WOOD SHELF	2
F	WOOD SCREWS	16
G	1-3/4" SCREWS	16
H	WALL ANCHORS	16

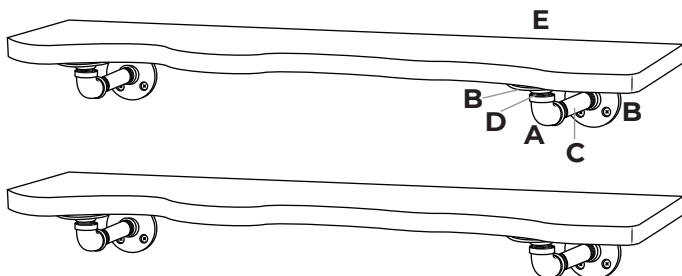
## 36" LIVE EDGE SHELF SET

(2) 36" Shelves with (2) L-Shaped Brackets



- F  (X 16)  
G  (X 16)  
H  (X 16)

PART	DESCRIPTION - FOR 36" LIVE EDGE SHELVES	QTY
A	1/2" 90° ELBOW	4
B	1/2" FLANGES	8
C	1/2" X 4" PIPE	4
D	1/2" CLOSE PIPE	4
E	36" LIVE EDGE WOOD SHELF	2
F	WOOD SCREWS	16
G	1-3/4" SCREWS	16
H	WALL ANCHORS	16

## EASY INSTALLATION:

## RECOMMENDED TOOLS FOR INSTALLATION

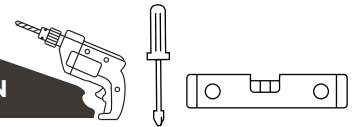

1. Assemble the brackets as shown in Figure 1. Hand tighten each piece.
2. Attach brackets to the wall (See Figure 2)

### A) Using stud finder, locate and mark wall stud

1. Place flange against wall in desired location and mark holes with pencil
2. Attach flange to wall with included screws

### B) If no wall stud is present

1. Place flange against wall in desired location and mark holes with pencil
2. Drill pilot holes in wall using 1/4" drill bit
3. Insert anchor fully into pilot hole using hammer and Phillips screwdriver as needed
4. Attach flange to wall using included screws.

3. Using a drill, screw the top of the bracket into the shelf as shown in Figure 3.

We recommend using setting #10 to prevent stripping the wood. There is no need to pre-drill.

FIGURE 1

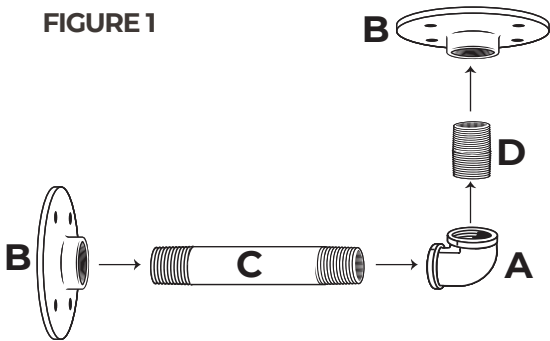

FIGURE 2

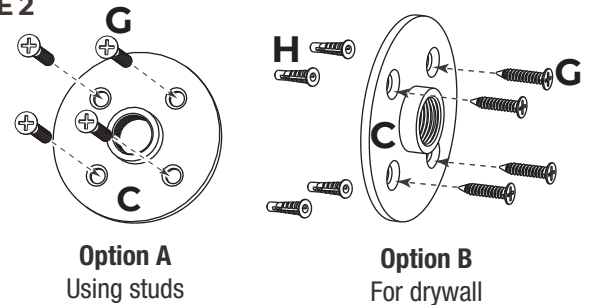
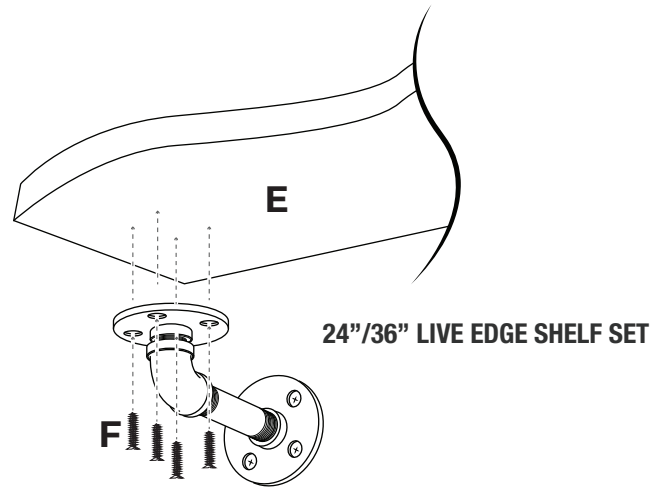
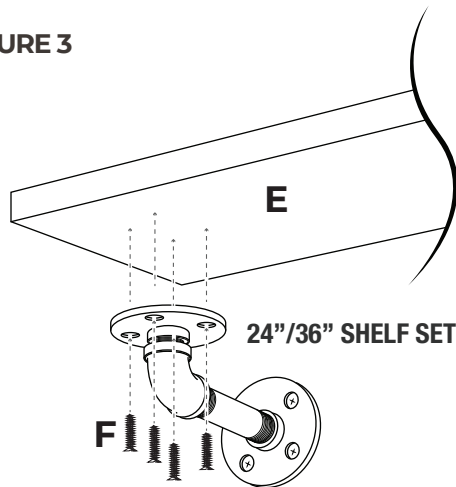

FIGURE 3



## HOW TO PREVENT PIPE CORROSION

PIPE DECOR industrial-grade black pipes and fittings are coated with a rust-preventive oil during manufacturing. For best results, **SEAL THE PIPES TO AVOID ANY RUSTING** after cleaning the kit.

### CLEAN AND SEAL INSTRUCTIONS:

Recommended supplies: regular degreasing dish soap, washcloths, gloves (optional)

1. Wash your pipes and fittings with warm water and dish soap until the oil is completely removed.
2. Wipe the pipes with a dry washcloth and wait until the pipes are completely dry.

**IMPORTANT: THE PIPES MUST BE COMPLETELY DRY BEFORE YOU START THE SEALING PROCESS.**

### SEALING WITH POLYURETHANE SPRAY:

Spray each dry pipe and fitting with a polyurethane matte or satin finishing spray and let it dry before assembling the kit.

### SEALING WITH FINISHING WAX:

Coat each dry pipe with a finishing wax. Wait for 20 minutes, then polish the pipe with a dry washcloth by wiping them down. Faster wiping will result in a shinier finish.