

4-ARM SPIDER LIGHT WITH PIPE CROSS HANGING ACCESSORY

NEED HELP OR ADVICE PUTTING THIS KIT TOGETHER? MISSING PIECES?
EMAIL US AT SUPPORT@PIPE-DECOR.COM FOR ANY QUESTIONS

IMPORTANT INFORMATION

Please read through all warnings and instructions before assembly.



WARNING

- Before installation, turn off electricity at the main fuse box by removing the fuse or switching off the circuit breaker.
- DO NOT cut or damage the wire insulation during assembly or installation. Do not allow wires to come into contact with sharp objects. Damaging the insulation could cause serious injury or death from electric shock.
- Contact your municipal building department to learn about your local codes before installation. All electrical connections must be in agreement with local codes.
- Most homes built before 1985 have supply wire that is rated for 140°F/60°C. Contact an electrician before installation to ensure there is no risk of fire.
- DO NOT connect this light fixture to an electrical system without a means for equipment grounding. If you're unsure, contact an electrician for information about proper grounding methods before installation.
- If using a dimmer switch with this light fixture, contact an electrician to determine the correct type and electrical rating you will need.

PREPARATION

Before assembly, ensure all parts are present. Compare parts with the contents listed in the package instructions. If any parts are missing or damaged, do not attempt to assemble or install this product. Contact us at help@pipe-decor.com for replacement parts.

FAQ

- 1. Why won't my light turn on?**
Three possible causes are a lack of power, bad wiring, or a faulty switch. Make sure the power is turned back on after installation. If the power is on but the light still will not work, consult a certified electrician for assistance.
- 2. Why does the circuit trip when I turn the light on?**
There may be crossed wires, or the power wire might be grounding out. Consult a certified electrician for assistance.

RETURN POLICY

- If you are not satisfied with your order for any reason, we offer returns or exchanges on all unused items for 30 days from the day of receipt. **Unfortunately, after 30 days, we cannot offer a refund or exchange.** If a product is damaged or defective, we will provide free replacements or repairs for up to 12 months from the date of purchase.
- Return shipping is paid by the buyer for all non-defective returns or exchanges. If the product is defective or damaged, we will provide a prepaid shipping label.

INCLUDED ACCESSORIES

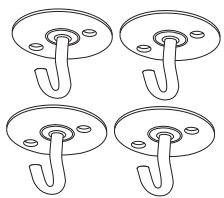

Hook x 4

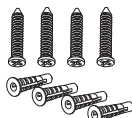

Ceiling screw & anchor x 8



Screw x 2



Wire Nut x 3

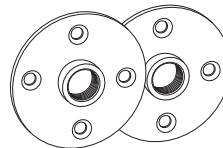

Flange x 2



90° Elbow x 2



Cap x 2

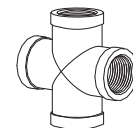

Cross x 1

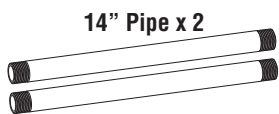

14" Pipe x 2

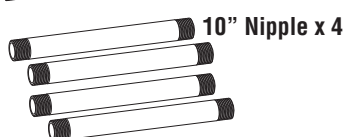

10" Nipple x 4



Washer x 2

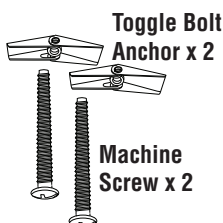

Toggle Bolt Anchor x 2

Machine Screw x 2

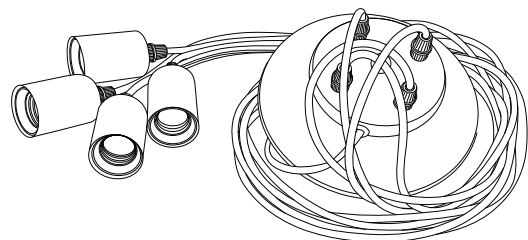

Pendant Light Fixture x 1

PIPE DECOR®

4-ARM SPIDER LIGHT WITH PIPE CROSS HANGING ACCESSORY

STEP 1 Chose a desired location that you would like to install the Spider Light.

STEP 3 Connect the ground wire and copper wire to the mounting unit.

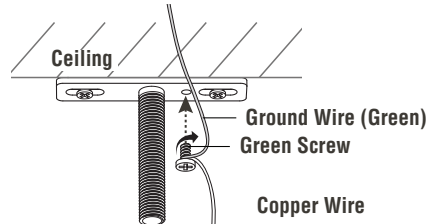

STEP 4 Connect the black and white wires and tighten it with wire nuts (Note: Connect black to black and white to white wires).

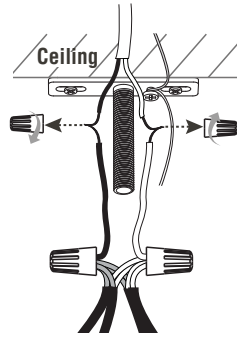

STEP 6 Assemble pipes and fittings.

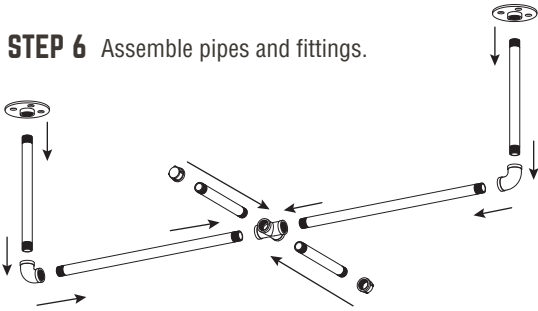

STEP 8 Using stud finder, check for studs where marks from flanges were made.

Where no studs/joists are found, drill two 1/2" pilot holes in ceiling for each flange.

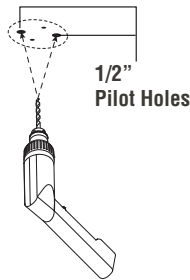

STEP 10 Thread on toggle bolt anchor.

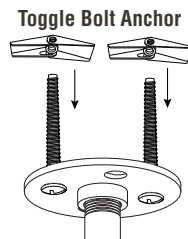

STEP 12 Use remaining screws to attach assembly to ceiling (drywall anchors not necessary).

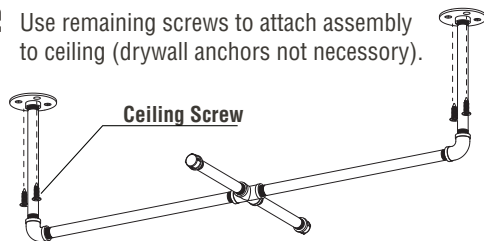

STEP 13 Install light bulbs (40W maximum per bulb)

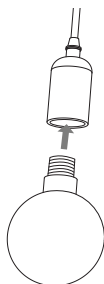

STEP 2 Attach mounting bracket to the existing junction box.

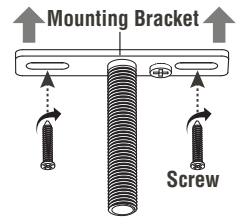

STEP 5 Install and secure the base plate, then install cap.

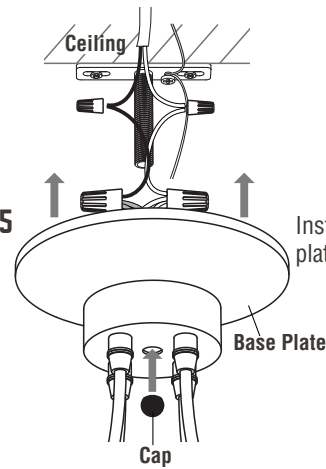

STEP 7 Hold assembly to ceiling and use pencil to mark screw holes for the flanges.

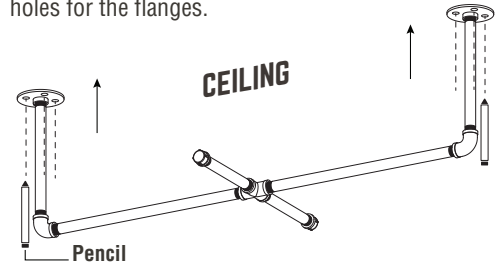

STEP 9 Insert Machine screws through flange in the location that matches the pilot holes (NOTE - Washers will not be used for this application).

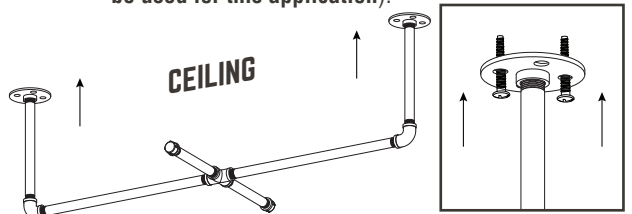

STEP 11 Compress wings and insert toggle anchor and wood assembly into the ceiling. Repeat at opposite end of board.

Screw in machine screw to secure assembly to ceiling.

