

Personal Computer
Model No. FZ-55 Series
Operating Instructions - Reference Manual



We recommend that this Reference Manual be printed.

Disclaimer

Computer specifications and manuals are subject to change without notice. Panasonic Corporation assumes no liability for damage incurred directly or indirectly from errors, omissions or discrepancies between the computer and the manuals. Refer for the latest information about optional products to the catalogs, etc.

Trademarks

- Microsoft, Windows, and the Windows logo are registered trademarks or trademarks of Microsoft Corporation of the United States and/or other countries.
- Intel, Core, and PROSet are either registered trademarks or trademarks of Intel Corporation.
- microSDXC Logo is a trademark of SD-3C, LLC.



- MobileMark® is a U.S. Registered Trademark of the Business Applications Performance Corporation.
- The terms HDMI and HDMI High-Definition Multimedia Interface, and the HDMI Logo are trademarks or registered trademarks of HDMI Licensing Administrator, Inc. in the United States and other countries.
- The Bluetooth® word mark and logos are registered trademarks owned by Bluetooth SIG, Inc. and any use of such marks by Panasonic Corporation is under license. Other trademarks and trade names are those of their respective owners.
- AMD, Radeon, and their combinations are trademarks of Advanced Micro Devices, Inc.
- Names of products, brands, etc., appearing in this manual are trademarks or registered trademarks of their respective own companies.

About the Software License

This product incorporates the following software:

- (1) the software developed independently by or for Panasonic Corporation,
- (2) the software owned by third party and licensed to Panasonic Corporation, and/or
- (3) open source software

The software categorized as (3) is distributed in the hope that it will be useful, but WITHOUT ANY WARRANTY, without even the implied warranty of MERCHANTABILITY or FITNESS FOR A PARTICULAR PURPOSE. Please refer to the detailed terms and conditions thereof shown below.

About zlib

```
/* zlib.h -- interface of the 'zlib' general purpose compression library
version 1.2.8, April 28th, 2013
```

Copyright (C) 1995-2013 Jean-loup Gailly and Mark Adler

This software is provided 'as-is', without any express or implied warranty. In no event will the authors be held liable for any damages arising from the use of this software.

Permission is granted to anyone to use this software for any purpose, including commercial applications, and to alter it and redistribute it freely, subject to the following restrictions:

1. The origin of this software must not be misrepresented; you must not claim that you wrote the original software. If you use this software in a product, an acknowledgment in the product documentation would be appreciated but is not required.
2. Altered source versions must be plainly marked as such, and must not be misrepresented as being the original software.
3. This notice may not be removed or altered from any source distribution.

Jean-loup Gailly Mark Adler
jloup@gzip.org madler@alumni.caltech.edu

```
*/
```

About Lib PNG

This copy of the libpng notices is provided for your convenience. In case of any discrepancy between this copy and the notices in the file png.h that is included in the libpng distribution, the latter shall prevail.

COPYRIGHT NOTICE, DISCLAIMER, and LICENSE:

If you modify libpng you may insert additional notices immediately following this sentence.

This code is released under the libpng license.

libpng versions 1.2.6, August 15, 2004, through 1.6.3, July 18, 2013, are Copyright (c) 2004, 2006-2013 Glenn Randers-Pehrson, and are distributed according to the same disclaimer and license as libpng-1.2.5 with the following individual added to the list of Contributing Authors

Cosmin Truta

libpng versions 1.0.7, July 1, 2000, through 1.2.5 - October 3, 2002, are Copyright (c) 2000-2002 Glenn Randers-Pehrson, and are distributed according to the same disclaimer and license as libpng-1.0.6 with the following individuals added to the list of Contributing Authors

Simon-Pierre Cadieux
Eric S. Raymond
Gilles Vollant

and with the following additions to the disclaimer:

There is no warranty against interference with your enjoyment of the library or against infringement. There is no warranty that our efforts or the library will fulfill any of your particular purposes or needs. This library is provided with all faults, and the entire risk of satisfactory quality, performance, accuracy, and effort is with the user.

libpng versions 0.97, January 1998, through 1.0.6, March 20, 2000, are Copyright (c) 1998, 1999 Glenn Randers-Pehrson, and are distributed according to the same disclaimer and license as libpng-0.96, with the following individuals added to the list of Contributing Authors:

Tom Lane
Glenn Randers-Pehrson
Willem van Schaik

libpng versions 0.89, June 1996, through 0.96, May 1997, are Copyright (c) 1996, 1997 Andreas Dilger Distributed according to the same disclaimer and license as libpng-0.88, with the following individuals added to the list of Contributing Authors:

John Bowler
Kevin Bracey
Sam Bushell
Magnus Holmgren
Greg Roelofs
Tom Tanner

libpng versions 0.5, May 1995, through 0.88, January 1996, are Copyright (c) 1995, 1996 Guy Eric Schalnat, Group 42, Inc.

For the purposes of this copyright and license, "Contributing Authors" is defined as the following set of individuals:

Andreas Dilger
Dave Martindale
Guy Eric Schalnat
Paul Schmidt
Tim Wegner

The PNG Reference Library is supplied "AS IS". The Contributing Authors and Group 42, Inc. disclaim all warranties, expressed or implied, including, without limitation, the warranties of merchantability and of fitness for any purpose. The Contributing Authors and Group 42, Inc. assume no liability for direct, indirect, incidental, special, exemplary, or consequential damages, which may result from the use of the PNG Reference Library, even if advised of the possibility of such damage.

Permission is hereby granted to use, copy, modify, and distribute this source code, or portions hereof, for any purpose, without fee, subject to the following restrictions:

1. The origin of this source code must not be misrepresented.
2. Altered versions must be plainly marked as such and must not be misrepresented as being the original source.
3. This Copyright notice may not be removed or altered from any source or altered source distribution.

The Contributing Authors and Group 42, Inc. specifically permit, without fee, and encourage the use of this source code as a component to supporting the PNG file format in commercial products. If you use this source code in a product, acknowledgment is not required but would be appreciated.

A "png_get_copyright" function is available, for convenient use in "about" boxes and the like:

```
printf("%s",png_get_copyright(NULL));
```

Also, the PNG logo (in PNG format, of course) is supplied in the files "pngbar.png" and "pngbar.jpg (88x31)" and "pngnow.png" (98x31).

Libpng is OSI Certified Open Source Software. OSI Certified Open Source is a certification mark of the Open Source Initiative.

Glenn Randers-Pehrson
glennrp at users.sourceforge.net
July 18, 2013

GOVERNMENT RESTRICTED RIGHTS.

The Software is provided with "RESTRICTED RIGHTS." Use duplication or disclosure by the government is subject to restrictions as set forth in FAR52.227-14 and DFAR252. 227-7013 et seq. or their successors.

Use of the Software by the government constitutes acknowledgement of Intel's proprietary rights therein.

Contractor or Manufacturer is Intel Corporation, 2200 Mission College Blvd., Santa Clara, CA 95052.

Panasonic Corporation
Osaka, Japan

Web Site : <https://panasonic.net/cns/pc/>

© Panasonic Corporation 2019

HS0719-1089
20180171ZAD

Illustrations and Terminology in this manual

- This manual explains using the default setting.
- In principle, this manual explains based on the following conditions:
 - When the keyboard and Touchpad are used for operation
- Some illustrations are simplified to help your understanding and may look different from the actual unit.
- Some types of software are automatically updated, and differences may occur from descriptions in this manual.
- If you do not sign in as an administrator, you cannot use some functions or cannot display some screens.
- This manual explains operation procedures using the Touchpad or mouse as typical examples. In addition, you can touch the display screen to operate the computer (only for model with touchscreen).

When using the touch operation, please replace the terms as described below, and read the instructions.



Operation terms to be replaced:

- Click → Touch
- Double-click → Double-touch
- Right-click → Touch and hold (Long touch)

Terms and illustrations in these instructions.

- « Enter » : This means to press the « Enter » key.
- « Fn » + « F7 » :
This means to press and hold « Fn » key, and then press « F7 » key.
- The display of the key may be different from this manual according to the keyboard used. (e.g. "Delete" instead of "Del")

- Click  -  :

Click  (Start) and then click  (Power).

In these instructions, the names are referred as follows.

- "Windows 10 Pro" as "Windows" or "Windows 10"
- DVD MULTI drive and Blu-ray disc drive as "optical disc drive".
- Circular media including BD-ROM, DVD-ROM and CD-ROM as "discs".
- "Multilanguage User Interface" as "MUI".
- The Touch Screen as the "touchscreen" (only for model with touchscreen).
- The stylus as the "pen (included)" (only for model with touchscreen).
- The computer screen supporting touching methods (using stylus / your fingers) is referred to as the "screen" (only for model with touchscreen).

Regarding Windows 10

Desktop mode and Tablet mode

Windows 10 offers the desktop mode in which operation is performed using the keyboard or Touchpad, and also the tablet mode optimized for the touch panel operation (only for model with touchscreen).

The mode can be switched by clicking  (Notification), and then clicking  (Tablet mode).

NOTE

- If some icons do not appear on the task tray, perform the following operations.

1. Touch and hold the task tray.
2. Select the item to display.

Screen Messages

Screen messages are explained in [English (United States)].

(Depending on the language preference, some screen messages in these instructions are different from the actual screen messages. For example, [Flight mode] may be displayed instead of [Airplane mode] in some language preference)

Opening the Control Panel

1. Click  (Start) - [Windows System] - [Control Panel].

Opening the Settings

1. Click  (Start) -  (Settings).

Latest Information on Windows 10

When Windows 10 is updated, the screen display or operation procedures may be changed.

For the latest information on Windows 10, see the following web page.

<https://pc-dl.panasonic.co.jp/itn/addendum/>



Sound and Video

- Sound (e.g. MP3, WMA) and video (e.g. MPG, WMV) recorded in microSD Memory Card may be interrupted during playback. If this happens, copy them to the flash memory drive and play back.
- Depending on the processing status on Windows, sound may be interrupted at Windows startup. You can mute the sound at startup. The startup sound is muted as the factory default.

1. Right-click  (Speakers) on the task tray, and click [Sounds].
2. Remove the check mark from [Play Windows Startup sound], and click [OK].

Windows Update

You can update to the latest patches and service packs for Windows with the following menus.

1. Click  (Start) -  (Settings) - [Update & Security] - [Windows Update].
2. Click [Check for updates].

Do not apply "Driver Updates" even if a message to update a driver appears. If a driver update is required, contact your technical support office.

Attaching/Detaching the keyboard

You can change to other language specific keyboard.

IMPORTANT

- Be sure to turn off the computer before attaching or detaching the keyboard.

To attach and detach the keyboard

1. Turn off the computer and disconnect the AC adaptor.
2. Remove the battery pack ([▶ Replacing the Battery Pack](#)).
<When using second battery pack>
 - Remove the second battery pack. ([▶ Replacing the Battery Pack](#))
3. Remove the screws (A) and the keyboard plate (B).

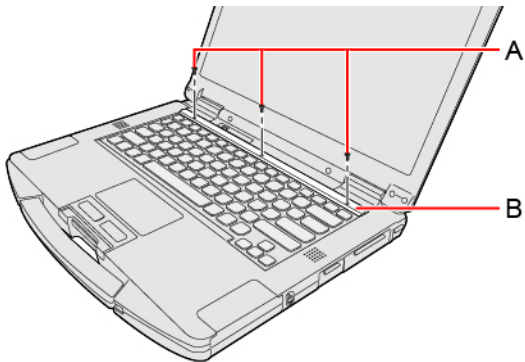

4. Lift the keyboard from the screen side.
 - The back side of the keyboard is affixed a seals (C).

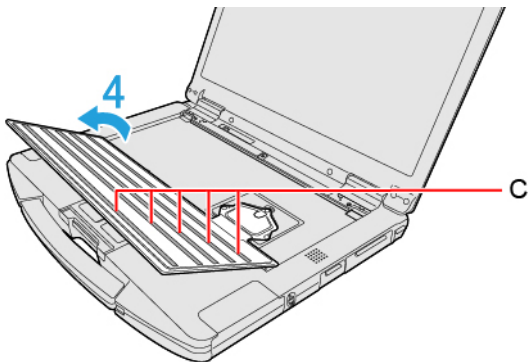

5. Remove the screws (D) and disconnect the stack type connector (E).

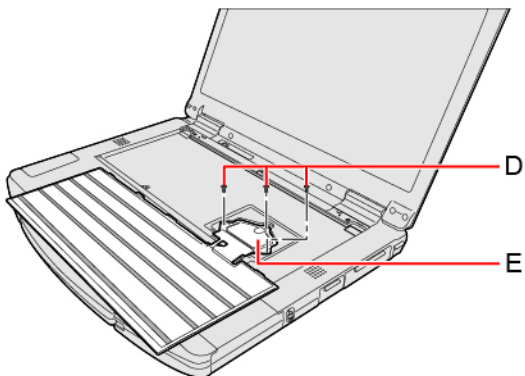

IMPORTANT

- You cannot use the removed keyboard again.

6. Connect the stack type connector of other language specific keyboard.

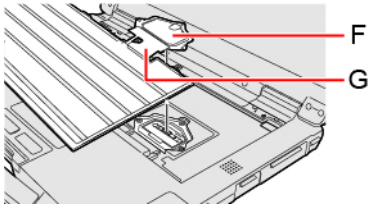

IMPORTANT

- Do not pull the flat cable (G) connecting the keyboard and stack type connector (F) forcibly.

7. Tighten the screws (H) firmly.

Use the PH 1 (PH #1) screwdriver.

The screws used are 3.

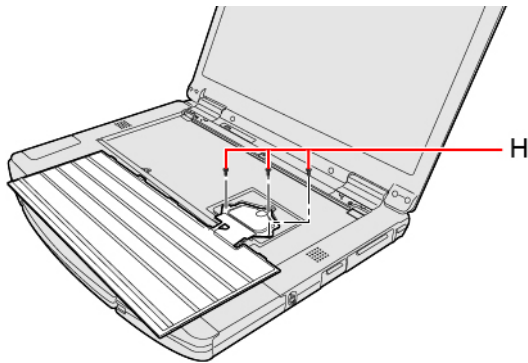

Recommended tightening torque

0.45 N•m ± 0.05 N•m (4.5 kgf•cm ± 0.5 kgf•cm)

8. Remove the release paper (I).

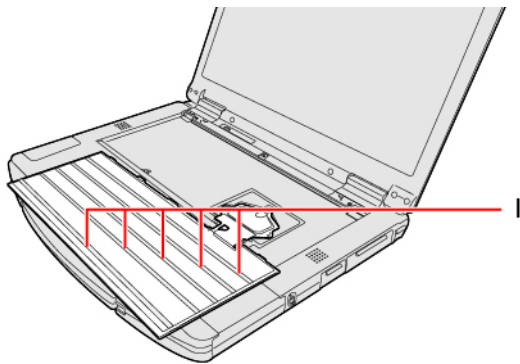

9. Insert the projection parts (J) of the keyboard into the (K) parts, and attach it while lowering.

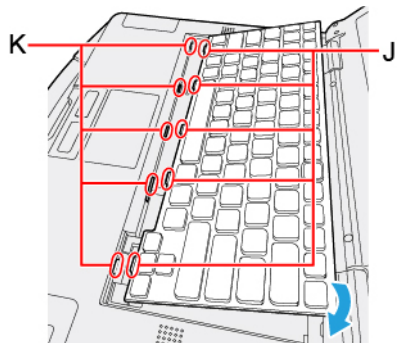

10. Attach the keyboard plate (B) and tighten the screws (L) firmly.

Use the PH 1 (PH #1) screwdriver.

The screws used are 3.

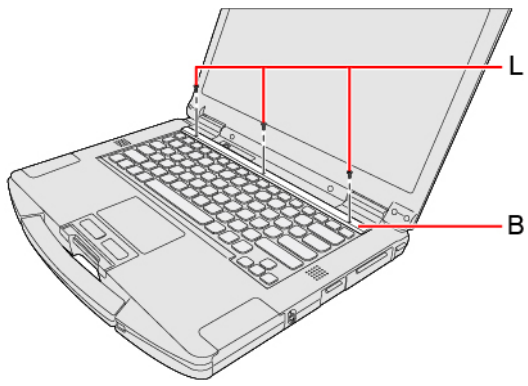

Recommended tightening torque

0.45 N•m \pm 0.05 N•m (4.5 kgf•cm \pm 0.5 kgf•cm)

11. **Insert the battery pack and connect the AC adaptor.**

Rear Expansion Area

You can select from the following options.



FZ-VCN551	FZ-VCN552	FZ-VCN553
VGA Port / Serial Port / USB 3.1 (Type-A) Port	VGA Port / Serial Port / 2nd LAN Port	VGA Port / Serial Port / Rugged USB 2.0 Port

Inserting an option to the rear expansion area

1. Turn off the computer and disconnect the AC adaptor.

IMPORTANT

- We recommend that you turn off the computer completely the following.

1. Click  (Start) -  (Settings) - [Update & Security] - [Recovery].
2. Click [Restart now] under "Advanced startup".
3. Click [Turn off your PC].

2. Turn your computer over and remove the battery pack ( [Replacing the Battery Pack](#)).

<When using second battery pack>

- Remove the second battery pack. ( [Replacing the Battery Pack](#))

Make sure no foreign objects are under the computer.

3. Insert an option to the rear expansion area.

1. If the dummy cover is inserted, remove it.
Remove the screws (A) and the dummy cover.

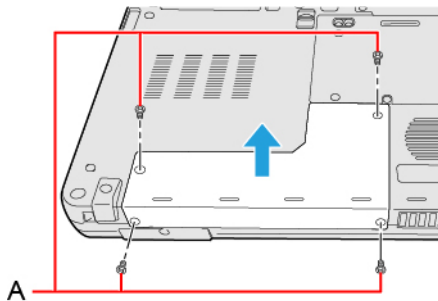

2. Press left and right from above to insert an option.

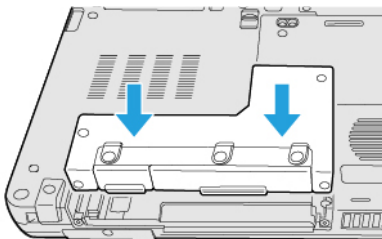

3. Tighten the screws (B) first, and then tighten the screws (C).
Use the PH 1 (PH #1) screwdriver.

The screws used are 4.

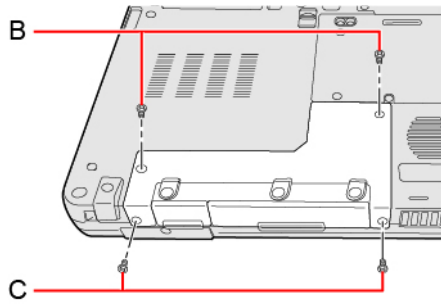

Recommended tightening torque

0.45 N•m \pm 0.05 N•m (4.5 kgf•cm \pm 0.5 kgf•cm)

4. Insert the battery pack carefully.

Front Expansion Area



You can select from the following options.

FZ-VZSU1HU	FZ-VSC551	FZ-VFP551	FZ-VNF551
Second Battery Pack	Smart Card Reader	Fingerprint Reader	Contactless Smart Card Reader

Inserting an option to the front expansion area

1. Turn off the computer and disconnect the AC adaptor.

IMPORTANT

- To insert a fingerprint reader, turn off the computer completely the following.
- Similarly for other options, we recommend that you turn off the computer completely the following.
 1. Click  (Start) -  (Settings) - [Update & Security] - [Recovery].
 2. Click [Restart now] under "Advanced startup".
 3. Click [Turn off your PC].

2. Turn your computer over and remove the battery pack ( [Replacing the Battery Pack](#)).

<When using second battery pack>

- Remove the second battery pack. ( [Replacing the Battery Pack](#))

Make sure no foreign objects are under the computer.

3. Insert an option to the front expansion area.

1. If the dummy pack is inserted, remove it.

While sliding the latch (A), pull out the dummy pack.

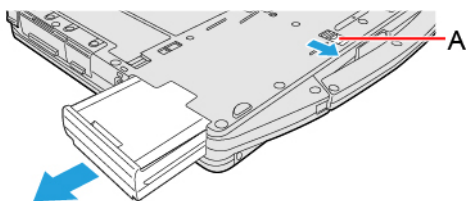

2. Slide an option in parallel with the arrow direction until it click to the secured position.

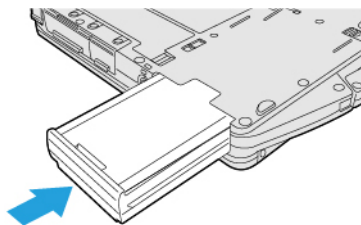

4. Insert the battery pack carefully.

TOUGHBOOK Universal Bay



You can select from the following options.

FZ-VDM551	FZ-VBD551	FZ-VGT551	FZ-VSD551	FZ-VSC552
DVD MULTI Drive Pack	Blu-ray Disc Drive Pack	GPU Pack	SSD Pack	Smart Card Reader

Inserting an option to the TOUGHBOOK universal bay

1. Turn off the computer and disconnect the AC adaptor.

IMPORTANT

- To insert a SSD Pack, turn off the computer completely the following.
- Similarly for other options, we recommend that you turn off the computer completely the following.
 1. Click  (Start) -  (Settings) - [Update & Security] - [Recovery].
 2. Click [Restart now] under "Advanced startup".
 3. Click [Turn off your PC].

2. Turn your computer over and remove the battery pack ( [Replacing the Battery Pack](#)).

<When using second battery pack>

- Remove the second battery pack. ( [Replacing the Battery Pack](#))

Make sure no foreign objects are under the computer.

3. Insert an option to the TOUGHBOOK universal bay.

1. If the dummy pack is inserted, remove it.

While sliding the latch (A), pull out the dummy pack.

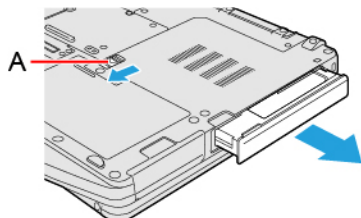

2. Slide an option in parallel with the arrow direction until it click to the secured position.

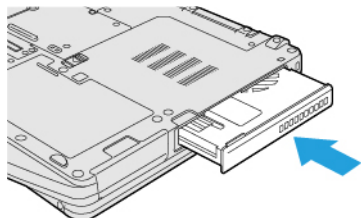

3. <When using discreted GPU>

Tighten the screws (B) supplied with discreted GPU.

Use the PH 1 (PH #1) screwdriver.

The screws used are 3.

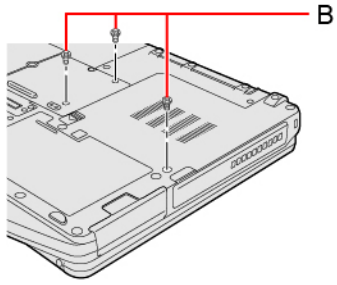

Recommended tightening torque

0.45 N•m \pm 0.05 N•m (4.5 kgf•cm \pm 0.5 kgf•cm)

4. Insert the battery pack carefully.

Create a Recovery Disc

You can make a recovery disc for preinstalled software.

The recovery disc returns the flash memory to the factory default. To create a backup of the recent state of the flash memory, refer to [Flash Memory Backup/Restore Function](#).

Preparation

- Blank discs (About usable types of discs and required numbers of discs, refer to the screen.) or USB storage device.
- <Only for model without optical disc drive>
When using DVD/BD media to create a recovery disc, prepare the commercially available optical drive.
- USB memory device can also be used as a recovery disc.
- Connect the AC adaptor and do not remove it until the operation is complete.
- Close all applications except for this utility.
- Remove all peripherals (excluding the device that will be used to create the recovery disc).
- Turn off the wireless function.

NOTE

- When this computer is driven by USB Power Delivery, the recovery disc cannot be created. Connect the supplied AC adaptor.
- If the recovery partition is deleted, you cannot create recovery disc(s).



<When using a USB storage device to create a recovery disc>

- Any previously existing data stored on the USB storage device will be deleted.
- USB storage devices with capacities insufficient for creating a recovery disc cannot be used.
- USB storage devices that are partitioned cannot be used.
- USB storage devices that are recognized as SCSI (i.e., UASP*1 devices) cannot be used.

*1 : USB Attached SCSI Protocol.

IMPORTANT

- USB memory device can also be used as a recovery disc.
- Do not perform the following operations until creating the recovery disc is complete.
 - Shut down or restart Windows.
 - Enter modern standby (sleep) or hibernation.
 - <Only for model without optical disc drive>
Remove the commercially available optical drive or USB storage device being used for recovery disc creation.
- If you interrupted creating a recovery disc, a message of failure may appear in step 10 screen below. In this case, restart the computer, and create a new recovery disc again.

1. Sign in to Windows as an administrator.
2. Connect the device being used to create the recovery disc to the unit.
 - For DVD/BD media
 1. <Only for model without optical disc drive>
Connect the commercially available optical drive to the USB Port.
 2. Set a disc into the optical disc drive or the commercially available optical drive.
 - For USB storage devices
 1. Connect the USB storage device to the USB port.
3. Click  (Start) -  (Panasonic PC Recovery Disc Creation Utility).
If the "User Account Control" screen appears, click [Yes].
4. Click [Next].
5. Confirm on-screen information ([Select OS Image] and [Number of discs required]), and then click [Next].

6. **Select the drive, and in the case of DVD/BD media, select the disc type.**

7. **Click [Next].**

8. **In the case of DVD/BD media, select the [Write Speed].**

9. **Click [OK].**

Creation of the recovery disc (i.e., writing) starts. Wait a moment for the process to complete.

10. **Finish creation of the recovery disc as follows.**

- For DVD/BD media

1. Remove the disc when "Recovery disc #1 complete." appears, and label the disc to avoid losing it.
Do not use sharp objects that may leave a mark.
2. If the recovery disc spans multiple discs, insert the next disc.
3. Click [OK].
4. Follow the on-screen instructions to create all the recovery discs.
5. Click [OK] on the "All recovery discs complete." screen.

- For USB storage devices

1. Click [OK] on the "All recovery discs complete." screen.
2. Perform "Safely Remove Hardware and Eject Media", and remove the USB storage device.

NOTE

- **The disc created with this utility is only for this computer. You cannot use for others.**
- **Additional applications cannot be recovered even if you use a recovery disc created with this utility.**
- **If you fail to create a recovery disc or an error message appears, try either of the following procedures.**
 - Insert the disc or USB storage device correctly.
 - Check the disc or USB storage device condition.
 - Restart the computer and try to create a recovery disc again.
 - Contact Panasonic Technical Support.

IMPORTANT

- Do not add or delete partitions in Windows 10, as the Windows area and recovery partition must be adjacent to each other in Windows 10.

Flash Memory Backup/Restore Function

Panasonic Corporation will bear no responsibility for any damage suffered (including loss of data) as a result of the use of this function.

Creating a Backup of the Flash Memory Data

You can create a backup of the flash memory data, which can be used to recover from hardware failure.

This function creates a backup of the recent state of the flash memory. To return the factory default, use a recovery disc. ( [Create a Recovery Disc](#))

To create a backup of the flash memory to another storage media (e.g., external hard disk).

Connect the storage media, and follow the steps below.



1. Click  (Start) - [Windows System] - [Control Panel] - [System and Security] - [File History].
2. Click [System Image Backup].
3. Click [Create a system image].
Follow the on-screen instructions.

NOTE

- Connect the AC adaptor and do not remove it until backup is complete.

Restoring the Flash Memory Data

Connect the storage media that created the backup.

1. Click  (Start) -  (Settings) - [Update & Security] - [Recovery].
2. Click [Restart now] under "Advanced startup"^{*1}.
3. Click [Troubleshoot] - [Advanced options].
4. Click [System Image Recovery].
Follow the on-screen instructions.

*1 : Screen messages are explained in [English (United States)].

(Depending on the language preference, some screen messages in these instructions are different from the actual screen messages. For example, [Advanced start-up] may be displayed instead of [Advanced startup] in some language preference.)

Description of Parts

Front side

<Only for model without camera>

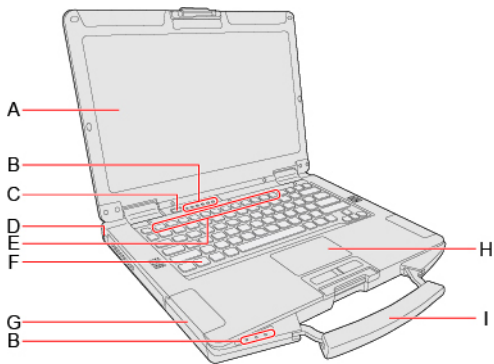

<Only for model with camera>

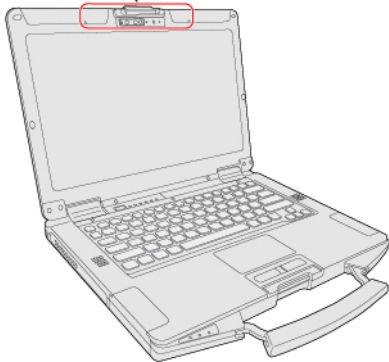
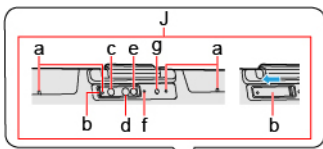

A. LCD

B. LED Indicator



: Caps Lock indicator



: Num Lock (numeric lock) indicator



: Scroll Lock indicator



: Drive Indicator (Drive status)



: microSD Memory Card Indicator

(Blinking: During access or a password is requested)



: Power Indicator

- Off: Power off/Hibernation
- Green: Power on
- Blinking Green: Modern standby (Sleep)
- Blinking green and orange: Cannot power on or resume due to low temperature.



: Battery Indicator 1

(→ When the battery indicator does not light on)

(→ Battery Power)

02: Battery Indicator ^{*1}

(➔ [When the battery indicator does not light on](#))

(➔ [Battery Power](#))

*1: When using second battery pack

C. Power Switch

D. Security Slot

A Kensington cable can be connected. For further information, read the manual that comes with the cable.

E. Function (Fn) Keys

F. Keyboard

(➔ [Attaching/Detaching the Keyboard](#))

G. Battery Pack Slot

H. Touchpad

(➔ [Touchpad](#))

I. Carrying Handle

Do not use the handle if the handle is worn or damaged.

J. Camera

<Only for model with camera>

(➔ [Camera](#))

a. Microphone

b. Camera Cover

When not using an IR camera, close the camera cover.

When opening and closing the camera cover, operate until it click to the secured position.

c. IR Camera

d. IR camera lights (RED)

e. Camera Lens

f. Camera Indicator

g. Ambient Light Sensor

The ambient light sensor is equipped with an automatic brightness adjustment function that adjusts the display screen. (➔ [Automatic brightness adjustment](#))

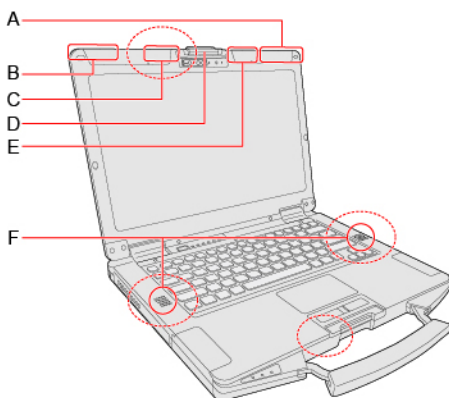

A. 2nd Wireless LAN Antenna / Wireless WAN Antenna / GPS Antenna

<Only for model with 2nd wireless LAN>

(➔ [Wireless LAN](#))

<Only for model with wireless WAN>

(➔ [Wireless WAN](#))

<Only for model with dedicated GPS>

(➔ [GPS](#))

B. 2nd Wireless LAN Antenna / Wireless WAN Antenna

<Only for model with 2nd wireless LAN>

( [Wireless LAN](#))

<Only for model with wireless WAN>

( [Wireless WAN](#))

C. Wireless LAN Antenna

<Only for model with wireless LAN>

( [Wireless LAN](#))

D. Display Latch

E. Wireless LAN Antenna / Bluetooth Antenna

<Only for model with wireless LAN>

( [Wireless LAN](#))

<Only for model with Bluetooth>

( [Bluetooth](#))

F. Speaker

NOTE

- This computer contains a magnet and magnetic products at the locations dashed line circled in the illustration above. Avoid leaving metallic object or magnetic media in contact with these areas.

■ Right side

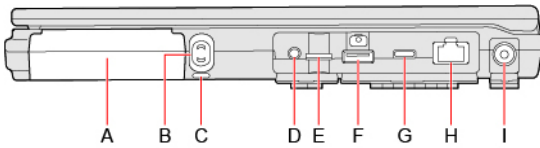

A. Front Expansion Area

You can set it yourself and select it later.

You can select from the following options.

FZ-VZSU1HU	FZ-VSC551	FZ-VFP551	FZ-VNF551
Second Battery Pack	Smart Card Reader	Fingerprint Reader	Contactless Smart Card Reader

<Only for model with Second Battery Pack>

( [Replacing the Battery Pack](#))

<Only for model with Smart Card Reader>

( [Smart Card](#))

<Only for model with Fingerprint Reader>

( [Fingerprint Reader](#))

<Only for model with Contactless Smart Card Reader>

( [Contactless Smart Card Reader/RFID Reader](#))

B. Pen Holder

<Only for model with touchscreen>

C. Tether Hole

D. Headset Jack

A headset or headphone can be connected.

E. microSD Memory Card Slot

Keep microSD Memory Cards away from infants and small children.

(→ [microSD Memory Card](#))

F. **USB 3.1 (Type-A) Port**

(→ [USB Devices](#))

G. **USB 3.1 (Type-C) Port**

(→ [USB Devices](#))

H. **LAN Port**

(→ [LAN](#))

I. **DC-IN Jack**

■ **Rear side**

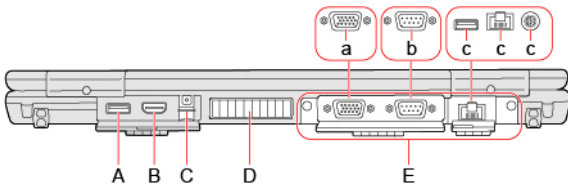

A. **USB 3.1 (Type-A) Port**

(→ [USB Devices](#))

B. **HDMI Port**

(→ [External Display](#))

C. **nanoSIM Card Slot**

<Only for model with wireless WAN>

(→ [Wireless WAN](#))

D. **Ventilation Hole (Exhaust)**

E. **Rear Expansion Area**

You can set it yourself and select it later.

You can select from the following options.

FZ-VCN551	FZ-VCN552	FZ-VCN553
VGA Port / Serial Port / USB 3.1 (Type-A) Port	VGA Port / Serial Port / 2nd LAN Port	VGA Port / Serial Port / Rugged USB 2.0 Port

a. **VGA Port**

b. **Serial Port**

c. **USB 3.1 (Type-A) Port / 2nd LAN Port / Rugged USB 2.0 Port**

<Only for model with VGA port / Serial port / USB 3.1 (Type-A) port>

(→ [External Display](#))

(→ [Serial Port](#))

(→ [USB Devices](#))

<Only for model with VGA port / Serial port / 2nd LAN Port>

(→ [External Display](#))

(→ [Serial Port](#))

(→ [LAN](#))

<Only for model with VGA port / Serial port / Rugged USB 2.0 Port>

(→ [External Display](#))

(→ [Serial Port](#))

(→ [USB Devices](#))

Bottom Side

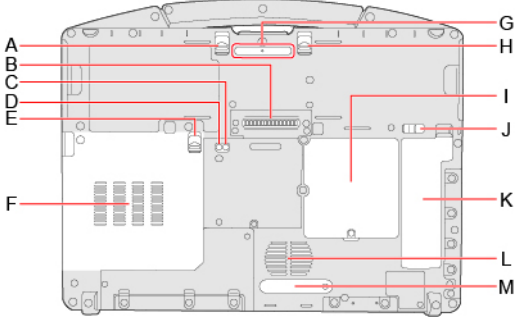

- A. **Battery Pack Latch**
- B. **Expansion Bus Connector**
(→ [Port Replicator \(CF-VEB541 series\)](#))
- C. **External Antenna Connector (CH2)**
<Only for model with External Antenna Connector>
- D. **External Antenna Connector (CH1)**
<Only for model with External Antenna Connector>

NOTE

- The following factory preset combinations are available for the external antenna output.

CH1	CH2
WLAN main	WWAN main
WLAN main	Dedicated GPS
Dedicated GPS	WWAN main
WWAN-GPS	WWAN main

- E. **TOUGHBOOK Universal Bay Latch**
- F. **TOUGHBOOK Universal Bay**
You can upgrade it yourself and select it later.
You can select from the following options.

FZ-VDM551	FZ-VBD551	FZ-VGT551	FZ-VSD551	FZ-VSC552
DVD MULTI Drive Pack	Blu-ray Disc Drive Pack	GPU Pack	SSD Pack	Smart Card Reader

<Only for model with DVD MULTI Drive Pack>

(→ [Optical Disc Drive](#))

<Only for model with Blu-ray Disc Drive Pack>

(→ [Optical Disc Drive](#))

<Only for model with GPU Pack>

(→ [Discreted GPU](#))

<Only for model with SSD Pack>

(→ [SSD Pack](#))

<Only for model with Smart Card Reader>

(→ [Smart Card](#))

- G. **LED Indicator**

Q1: Battery Indicator 1

( [When the battery indicator does not light on](#))

( [Battery Power](#))

P1 / Q2: Battery Indicator 2^{*2}

( [When the battery indicator does not light on](#))

( [Battery Power](#))

*2: When using second battery pack

H. **Front Expansion Area Latch**

I. **RAM Module Slot**

J. **SSD Pack Latch**

K. **SSD Pack Slot**

L. **Ventilation Hole (Intake)**

M. **Dust Cover**



( [Handling and Maintenance](#))

Turning On / Turning Off

Turning On



Press and hold the power switch  until the power indicator  lights. ([Description of Parts](#))

NOTE

- Do not press the power switch repeatedly.
- The computer will forcibly be turned off if you press and hold the power switch  for ten seconds or longer.
- Once you turn off the computer, wait for ten seconds or more before you turn on the computer again.
- Do not perform the following operation until the drive indicator  turns off.
 - Connecting or disconnecting the AC adaptor
 - Pressing the power switch
 - Touching the keyboard, touchpad, touchscreen <only for model with touchscreen> or external mouse
 - Closing the display



Turning Off

Shut down the computer.

1. Click  (Start).
2. Click  (Power) - [Shut down].

NOTE

To turn off the computer completely, proceed as follows.

1. Click  (Start) -  (Settings) - [Update & Security] - [Recovery].
2. Click [Restart now] under "Advanced startup".
3. Click [Turn off your PC].

Precautions against Starting Up/Shutting Down

Do not do the following

- Connecting or disconnecting the AC adaptor
- Pressing the power switch
- Touching the keyboard, touchpad, touchscreen <only for model with touchscreen> or external mouse
- Closing the display

NOTE

- To conserve power, the following power saving methods are set at the time of purchase.

-
- The screen automatically turns off after :
 - 10 minutes (when AC adaptor is connected) of inactivity
 - 4 minutes (when operating on battery power) of inactivity
 - The computer automatically enters sleep^{*1} after :
 - 10 minutes (when AC adaptor is connected) of inactivity
 - 4 minutes (when operating on battery power) of inactivity

*1 : Refer to "[Sleep/Hibernation Functions](#)" about resuming from sleep.

Touchpad

Use the touchpad to move the cursor on the screen and perform computer operations.

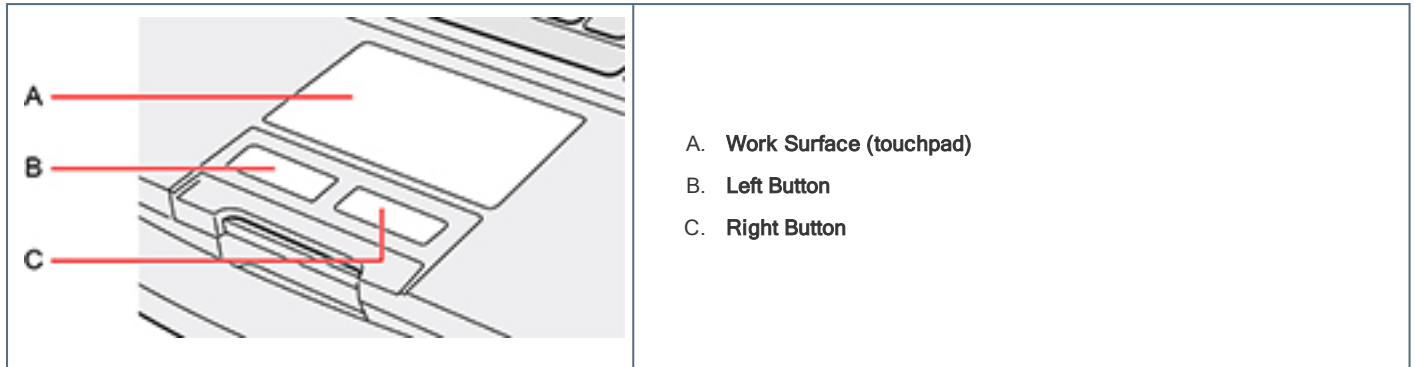

You can change the settings of touchpad by performing the following operation.

1. Click  (Start) -  (Settings) - [Devices] - [Touchpad].

Disabling/Enabling the Touchpad

1. Press **«Fn» + «Esc»** ( [Key Combinations](#)).

You can check the status of the touchpad by seeing an icon on the task tray.





: Touchpad is enabled.



: Touchpad is disabled.



NOTE

- When the touchpad is disabled, it will remain disabled until you press **«Fn» + «Esc»** again, even if the computer restarts.
- This function cannot be used with this unit even if you perform the following operations.

1. Click  (Start) -  (Settings) - [Devices] - [Touchpad].
2. Add the check mark to [Press the lower right corner of the touchpad to right-click] under "Taps".

Changing the Cursor Speed of Touchpad

- You can change the cursor speed of touchpad by performing the following operation.

1. Click  (Start) -  (Settings) - [Devices] - [Touchpad].
2. Slide the bar under "Change the cursor speed".

When you move the slider to the left, the cursor speed is slow.



Handling the touchpad





- By design, the touchpad is to be used with a fingertip only. Do not place any object on the work surface or press down forcefully with sharp-pointed objects (e.g., nails) or hard objects that can leave marks (e.g., pencils and ball point pens).
- Try to avoid having any harmful substances, such as oil, come in contact with the touchpad. The cursor may not work properly in such cases.
- When the touchpad becomes dirty:







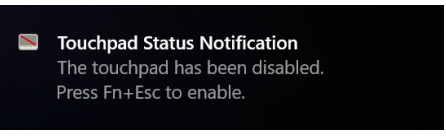

Wipe to remove dirt by using a dry soft cloth such as gauze or a soft cloth first applied with detergent diluted with water and then thoroughly wrung. Do not use benzene or thinner, or rubbing alcohol. Doing so may adversely affect the surface, e.g., discoloration. In addition, do not use commercially available household cleaners and cosmetics, as they may contain components harmful to the surface.













Key Combinations







NOTE

- Do not repeatedly press the keys in quick succession.
- Do not use the key combinations together with touchpad (external mouse), touchscreen (only for model with touchscreen) or other key operations.
- Do not use the key combinations before you sign in to Windows. Wait until the drive indicator  and the microSD Memory Card indicator  turn off. On the Setup Utility screen, you can use the key combinations of «Fn» + «F1» and «Fn» + «F2». By using the key combinations of «Fn» + «F3», the display is switched between the internal LCD, simultaneous display and the external display.
- The key combinations may not work with some applications.
- The pop-up display shown in the table below appears after signing in to Windows. It may not appear in some application conditions.

Key	Function	Pop-up display
«Fn» + «Esc» 	Touchpad on/off You can select on/off of the touchpad. <div style="background-color: #0070C0; color: white; padding: 5px; text-align: center;">NOTE</div> <ul style="list-style-type: none"> You can check the status of the touchpad by seeing an icon on the task tray. ( Disabling/Enabling the Touchpad) When the touchpad is disabled, it will remain disabled until you press «Fn» + «Esc» again, even if the computer restarts. 	
«Fn» + «F1» *1 «Fn» + «F2» *1  	LCD brightness («Fn» + «F1» = down / «Fn» + «F2» = up)	A slide bar appears.

Key	Function	Pop-up display
« Fn » + « F3 » 	Display mode switching ( Switching the display mode) When an external display (a projector etc.) is connected, you can change the display mode. 1. Press « Fn » + « F3 » . 2. Click the display mode. <div style="background-color: red; color: white; text-align: center; padding: 5px; font-weight: bold; margin: 10px 0;">IMPORTANT</div> <ul style="list-style-type: none"> ■ Do not press any keys until the display has finished switching. ■ Do not use this function: <ul style="list-style-type: none"> ● When playing motion video such as DVD or MPEG. ● When an external display is not connected. ● When showing a game screen such as pinball. 	“PROJECT” appears.
« Fn » + « F4 » *1 	Speaker on/off*2 You can check the status of speaker by seeing an icon on the task tray.	A slide bar appears.   : Mute
« Fn » + « F5 » *1 « Fn » + « F6 » *1  	Volume (« Fn » + « F5 » = down / « Fn » + « F6 » = up) <div style="background-color: blue; color: white; text-align: center; padding: 5px; font-weight: bold; margin: 10px 0;">NOTE</div> <ul style="list-style-type: none"> ■ When fine-tuning the sound volume, press and hold « Fn » , and press « F5 » or « F6 » intermittently. ■ This does not work on speakers connected to the USB port. 	A slide bar appears.
« Fn » + « F7 » 	Modern standby (Sleep) ( Entering/Resuming from Sleep or Hibernation)	

Key	Function	Pop-up display
« Fn » + « F8 » *3 	<p>Concealed Mode on/off</p> <p>You can select on/off of indication status the following devices.</p> <ul style="list-style-type: none"> • LCD Backlight • LED • Sound • Wireless Radio • Backlit Keyboard <p>( Concealed Mode)</p> <div style="background-color: #0070C0; color: white; padding: 5px; text-align: center; font-weight: bold; margin-top: 10px;">NOTE</div> <hr/> <ul style="list-style-type: none"> ■ The camera indicator cannot be turned off. ■ Concealed Mode is enabled as the factory default. ■ You can set the devices turned off in [Concealed Mode Configuration] with Setup Utility. ■ If you press « Fn » + « F8 » in succession, the Concealed Mode may not be switched. More than 4 seconds interval is necessary to switch on/off. 	
« Fn » + « F9 » 	<p>Remaining battery power</p> <p>(When the battery pack is inserted in the computer)</p>	( Checking the Remaining Battery Power)
« Fn » + « F10 » 	<p>Airplane Mode on/off</p> <p>You can select on/off of the Airplane Mode.</p> <p>( Switching the airplane mode using « Fn »)</p>	
« Fn » + « F12 » 	<p><Only for model with backlit keyboard></p> <p>Backlit keyboard ON/OFF</p> <p>When you press the keys, the luminance of backlit keyboard is changed. (Four steps and off).</p> <p>You cannot change the color of the backlit keyboard. ( Panasonic PC Backlit Keyboard Settings Utility)</p> <p>When switched to [Night Mode] of “Panasonic PC Day Night Mode Utility”, « Fn » + « F12 » is disabled. ( Panasonic PC Day Night Mode Utility)</p>	
« Fn » + « 1 » 	<p>Open Panasonic PC Settings Utility ON/OFF</p> <p>You can change the functions. ( To change the A1 / A2 / A3 / A4 key functions)</p>	
« Fn » + « 2 » 	<p>Open A1/A2/A3/A4 Key Settings</p> <p>You can change the functions. ( To change the A1 / A2 / A3 / A4 key functions)</p>	

Key	Function	Pop-up display
« Fn » + « 3 » 	Day Night Mode switching You can change the Day Night Mode. ( Panasonic PC Day Night Mode Utility) When [Manual] of “Panasonic PC Day Night Mode Utility” is selected, « Fn » + « 3 » is enabled. You can change the functions. ( To change the A1 / A2 / A3 / A4 key functions)	
« Fn » + « 4 » 	<Only for model with backlit keyboard> Backlit keyboard color switching You can change the color of the backlit keyboard. ( Panasonic PC Backlit Keyboard Settings Utility) <Only for model without backlit keyboard> You can change the functions. ( To change the A1 / A2 / A3 / A4 key functions)	

*1 : These key combinations are disabled when [Concealed Mode] is enabled.

*2 : Even if [Sound] is set to [OFF] on the [Concealed Mode Configuration] menu, the sound volume setting of Windows does not show mute state. However, audio from the speaker is not heard.

*3 : You can also turn on/off the Concealed Mode by pressing « F8 ».

Change the [Trigger Key] setting in the sub-menu of [Concealed Mode Configuration] in the [Main] menu of the Setup Utility.





Hotkey Settings

You can make the following settings:

- **Fn key lock**

When you press « Fn », the key is locked (pressed-down) until you press another key. Use this when pressing difficult key combinations.

1. **Start up the Hotkey Settings.**

Click  (Start) -  (Panasonic PC Settings Utility) -  (Settings) -  (Button / Key).

2. **Make the settings.**



[Use Fn Key lock]

- When using an « Fn » key combination
 1. Press « Fn » once. (Locked)
 2. Press another key. (Lock released)
- When using successive « Fn » key combinations
 1. Press « Fn » twice. (Locked)
 2. Press another key.

Fn key remains locked until you press « Fn » again.

[Make sound when Fn Key is pressed]^{*4}

[Display icon in notification area]: Displays the Fn key status when  on the task tray is clicked.

-  : « Fn » is locked.
-  : « Fn » is not locked.

NOTE

- You can have different settings for each user.

*4 : If the speaker is muted or [Sound] is turned off in [Concealed Mode Configuration], beeps do not sound.

To change the A1 / A2 / A3 / A4 key functions

You can change the functions of A1, A2, A3 and A4 keys.

The A4 key can only be changed for models without backlit keyboard.

1. Click  (Start) -  (Panasonic PC Settings Utility) -  (Settings) -  (Button / Key).
2. Click [Change] under "A1/A2/A3/A4 Key".
3. Select the key and click [Change...].

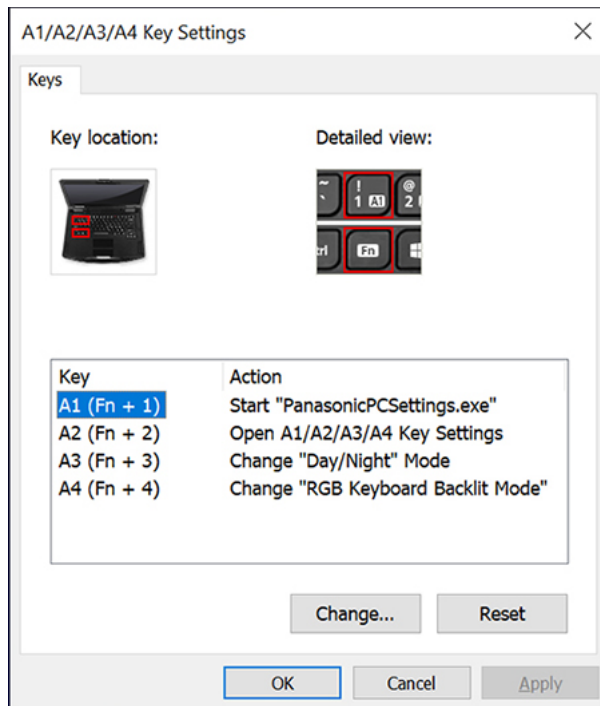

4. Select the function in [Action].
 - Click [Browse...] to select the application if you select [Start a program].
5. Click [OK].
6. Click [OK].

NOTE

- If you click [Reset], the setting will become the factory default.
- With the factory default, "A1/A2/A3/A4 Key Settings" can be launched by pressing  (<< Fn>> + << 2 >>).

Panasonic PC Backlit Keyboard Settings Utility

The Panasonic PC Backlit Keyboard Settings Utility can be used to make custom color of the backlit keyboard.

Starting Panasonic PC Backlit Keyboard Settings Utility

1. Click  (Start) -  (Panasonic PC Backlit Keyboard Settings Utility).



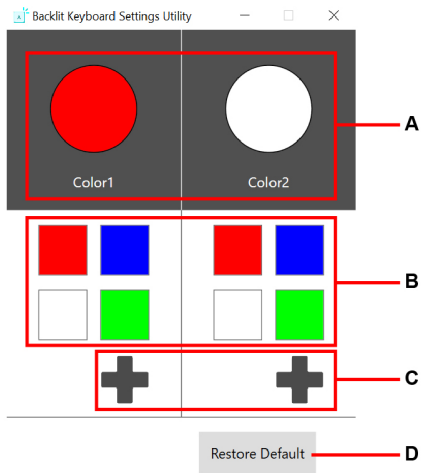

The Panasonic PC Backlit Keyboard Settings Utility starts up, and the following screen is displayed.





A. **[Color1] / [Color2].**

The specified color is displayed.

B. **Color Presets**

To change the color of the backlit keyboard, click  ,  ,  or  .

C. **Color Settings**

To customize the color of the backlit keyboard, click  . ( [To Define Custom Colors](#))

D. **Restore Default**

Restore the settings to the default color.

2. **Select the color of the backlit keyboard.**

To Define Custom Colors

1. Click  to display the "Color".

The following screen is displayed.



- When using the Basic Color

1. Click the color under "Basic colors:".
2. Click [OK].

- When using the Custom Color

1. Click the color under "Basic colors:" closest to the color you want to define.
2. Click "Define Custom Colors".

The following screen is displayed.

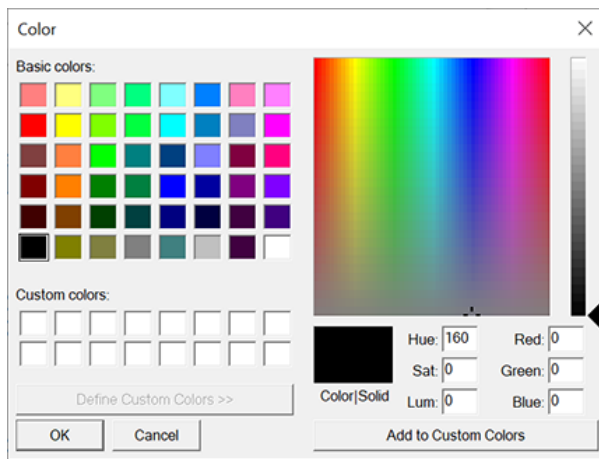

3. Modify the color matrix and slider.
Alternatively, modify the RGB or hue, saturation, luminosity color values.
4. Click [Add to Custom Colors].
5. Click the color under "Custom colors:".
6. Click [OK].

NOTE

- If you change the color of the backlit keyboard to black, the backlit keyboard does not light.
- You can also decrease the brightness automatically to conserve power with Setup Utility. (As factory default, [\[On Battery Power\]](#) and [\[Plugged in\]](#) are set to [\[None\]](#). Change the setting if you use the automatic turn off function of the backlit keyboard.)
- You can also change the color or the power saving time with Setup Utility.

Screen Input Operation

The screen of your computer allows you to perform the same operations as a mouse by touching its surface.

<Only for model with touchscreen>

You can use the touchscreen function to perform the same operation as the touchpad and mouse. The computer supports, using your fingers and the stylus (included).

NOTE

- Note that the touchscreen may respond to the following:
 - Putting the pen (included) or finger close to the screen.
 - Liquid or metallic objects other than the pen (included) or finger.

Attaching the pen to the computer

1. Insert the pen into the pen holder.

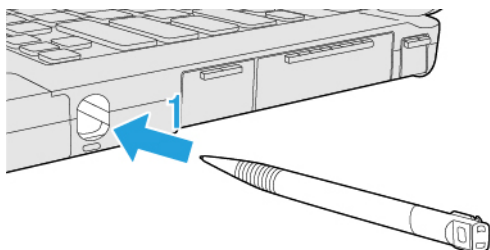

Detaching the pen from the computer

1. Press the pen so it comes out of the pen holder.
2. Draw it straight out.

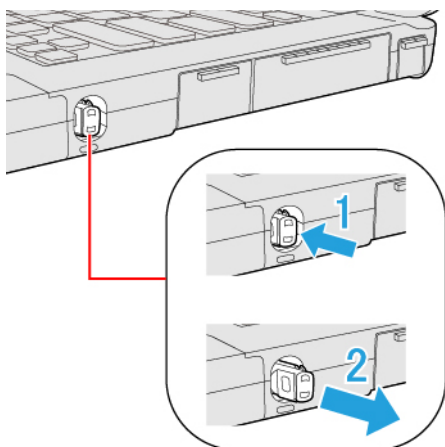

To operate "touch and hold" ("right-click")

- Touch and hold the object with your fingers, or the pen (included), and release it when a flame surrounding the object appears.

Operation by touching the screen

Instead of operating the screen with the pointer, you can use your fingers.

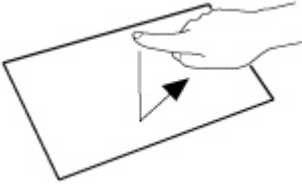
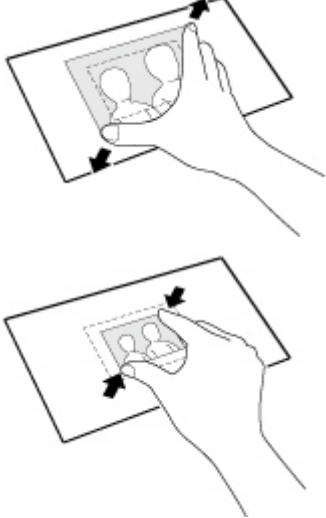
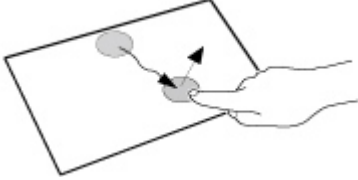
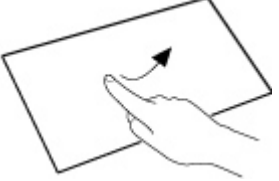
	Touch (Tap)	Touch the screen once with one finger.
	Spread / pinch	Touch an image or document with two fingers, and spread your fingers apart to zoom in or pinch them together to zoom out.
	Drag	Touch an object (file, icon, etc.) and drag your finger to the desired location before removing it to move the object.
	Swipe	Touch with a sweeping motion.
	Flick	Touch with a quick sweeping motion.

Change Touch Screen Mode

You can select the suitable operation mode in Touch Screen Mode.

1. Click  (Start) -  (Panasonic PC Settings Utility) -  (Settings) -  (Touch Screen).

2. Select the operation mode under "Touch Screen Mode".

[Pen] mode

- Suitable for pen (included) operation.
- Use this mode when not operating with finger.
- Using this mode may cause accidental response to metal objects close to the screen.
- Unless you have the pen (included), operation will not be possible.

[Pen/Touch] mode

- Suitable for using both finger and pen (included).
- If both the pen (included) and finger touch the screen at the same time, the pen (included) operation takes priority.
- Using this mode may cause accidental response to metal objects close to the screen.

[Touch] mode

- Suitable for finger operation.
- Use this mode when not operating with the pen (included).

[Touch (Glove)] mode

- Use this mode when operating with a glove on.
- Depending on the type of glove, operation may be ignored.
- With finger operation, the screen may not respond properly.

3. **If a confirmation message appears, click [Yes].**

IMPORTANT

- **Do not touch the screen while switching the operation mode. Switching may fail by doing so.**

Calibrating the Screen

When you cannot point correctly with the pen (included) or your fingers, calibrate the screen by following the steps below.

Perform the calibration as an administrator. A standard user needs to perform the calibration as an administrator before performing the calibration for each user.

NOTE

- **At first, sign in to Windows as an administrator, and perform this calibration.**

1. Open "Tablet PC Settings".

Click  (Start) - [Windows System] - [Control Panel] - [Hardware and Sound] - [Tablet PC Settings].

2. Click [Calibrate...].
3. Using the pen (included) or finger, touch each of the "+" target marks one by one, and then click [Yes].

NOTE

- The following message, "Right-click anywhere on the screen to return to the last calibration point. Press the Esc button to close the tool." will appear on the center of the screen during calibration. However, the operation to close the tool by pressing the « Esc » key can be performed.

IMPORTANT

- If you perform calibration as a standard user, the calibration data is valid until you sign out. (The data becomes invalid after you have signed out.) When using the computer continuously, perform calibration as an administrator.
- If you cannot operate the computer correctly after calibration, delete the calibration data by clicking [Control Panel] - [Hardware and Sound] - [Tablet PC Settings] - [Reset...], and perform calibration again. (Be sure to delete the calibration data as an administrator.)

Important Tips

Important Battery Tips

How to use the battery with minimal deterioration

The battery is a consumable and, as such, its performance will gradually deteriorate. This deterioration is accelerated under the following conditions.

- When the battery is repeatedly charged
- When the battery is used, charged or stored in a place with high temperature

To minimize deterioration of the battery and ensure a longer battery life, you must reduce the number of charges and ensure that the temperature inside the battery does not become too high. Bear in mind the following points.

NOTE

- The battery pack gradually deteriorates over time even if cared following the above points. If it deteriorates, be sure to replace with a new and specified battery pack.
- This computer reduces the full charge capacity in stages to ensure a longer life of the battery pack.

Charge the battery in a temperature range of 10 °C to 30 °C {50 °F to 86 °F}

In places where the outside air temperature is high, the temperature inside the battery will also become high. Do not charge the battery inside a vehicle with all its windows closed and exposed to the hot sun or in other places where the temperature is high.

This computer's battery will not be charged if its temperature is outside the allowable range. (At such a time, the battery indicator blinks orange.)

We recommend charging the battery no more than once per day

Recharging the battery after every small use raises the total number of battery charges and speeds battery deterioration.

To lower the total number of battery charges, we recommend recharging the battery no more than once per day or when the remaining charge drops to 10 % or less.

With this computer, in order to reduce the number of charges, the battery will not be recharged immediately after it has been fully charged unless the remaining charge has fallen to less than 95 %.

Charging the battery while the computer is powered off is recommended

If the computer's power is on, the temperature inside the battery rises due to the effects of heat from the CPU and other components. We recommend that you only charge the battery when the computer is powered off.

How to use the computer to maximize the battery operation time



Leave the computer off when it is not in use

Decrease the internal LCD brightness by pressing << Fn >> + << F1 >>

Pressing << Fn >> + << F1 >> will lower the degree of brightness, thereby reducing the power consumption.

Before stepping away from your computer, enter the modern standby (sleep) or hibernation mode

Refer to [Entering/Resuming from Sleep or Hibernation](#).

Click  or  on the task tray, and then move the "Power mode" slider () to the left to set the "Power mode" to "Best battery life".

This will reduce power consumption.

We recommend against using applications or screen saver that place a significant load on the CPU

Some screen savers place a large load on the CPU. When using these screen savers, a significant load is placed on the CPU even when the computer is not being used. We recommend that you do not use screen saver that will drain the CPU.

Remove peripheral devices (USB devices, external mouse, etc.) when not in use

When the network communication is not working, turn off the wireless LAN

When the computer is not going to be used for an extended period (a month or more)

In order to maintain the battery performance, remove the battery with a remaining charge of 30 % to 40 % from the computer, and store it in a cool, dark place

If the battery pack is kept installed in the computer, it will discharge gradually even when the computer's power is off. If this condition continues for a long period (several months or more), the battery may overdischarge, causing its performance to deteriorate. In addition, this deterioration will accelerate if the battery pack is stored inside a vehicle with all its windows closed and exposed to the hot sun or in other places where the temperature is high. Store the battery pack where the temperature is within the range of 10 °C to 30 °C {50 °F to 86 °F}.

Things to keep in mind when using the battery pack

Bear in mind the following points when installing and removing the battery pack

- Do not install or remove the battery pack while the computer is in the sleep mode.
Removal of the battery pack in this mode cause the data to be erased and cause the computer to malfunction.
- Do not touch the terminals on the battery pack.
If the terminals are dirty or damaged, the battery may not function properly or the computer may not operate properly.

Charging time and discharging time differs depending on the computer's power status and temperature

- It takes longer to fully charge the battery when the computer's power is on. To charge the battery more quickly, power the computer off, or put it in the sleep or the hibernation mode.
- It takes longer to fully charge the battery in low temperature environments. The battery discharges more quickly in low temperature environments.

Battery Indicator

Battery indicator (situation in use):  (A) and  (B) ^{**1}

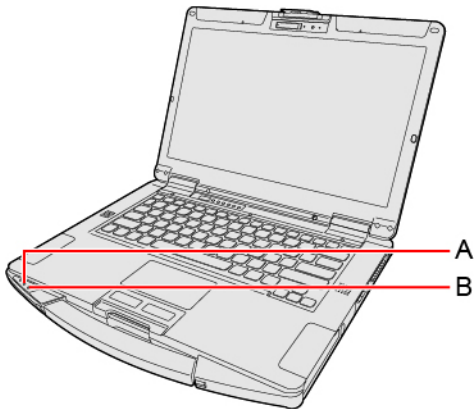

Battery indicator	Battery status
Not lit	<ul style="list-style-type: none"> The battery pack is not inserted or not being charged. Concealed mode is set to ON.
Orange	Charging is in progress. If Battery Charging Indicator in the [Main] menu of the Setup Utility is set to [Flashing], the indicator will alternately become lighter and darker (Flashing).
Green	The battery is fully-charged.
Blinking green	In order to stop the battery from deteriorating, power supply from another battery or AC adaptor has been shut off, and the battery power is being consumed. Do not remove the battery pack in this status.
Red	The remaining battery is approximately 9 % or less.
Blinking red	The battery pack or the charging circuit is not operating properly. Remove the battery pack immediately.
Blinking orange	The battery cannot be charged temporarily due to the following reasons: <ul style="list-style-type: none"> Its internal temperature is out of the acceptable range. The power supply is not enough because software applications or peripheral devices are consuming a large amount of power. When charging the computer using USB Power Delivery. The power of the connected USB Power Delivery-compatible device is insufficient.
Blinking green and orange alternately	The temperature is low and the computer is warming up to prevent the flash memory drive from malfunctioning. The computer will start automatically after warming-up.
Blinking orange slowly	When you set [Battery Charging Indicator] to [Flashing] on the [Main] Menu of Setup Utility.

Battery indicator (replacing status):   (C) ^{**1}

<Only for model with second battery pack>

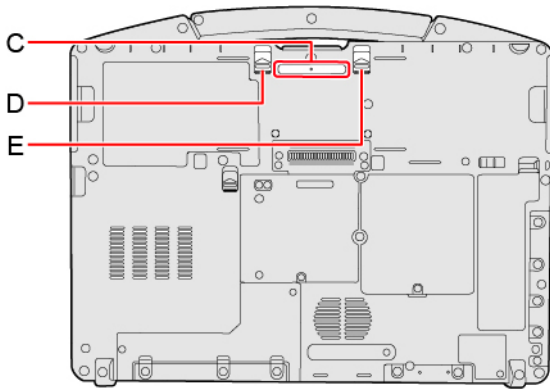

Battery indicator	Battery status
Green	The battery pack can be replaced. (When the battery latch (D) and second battery pack latch (E) (Only for model with second battery pack) is slid with the AC adaptor disconnected, either battery pack remains the battery power.)
Blinking red	The battery packs cannot be replaced.
Not lit	<ul style="list-style-type: none"> The battery pack is not inserted or not being charged or other than those above. Concealed mode is set to ON.

NOTE

- Once the battery is fully charged, the computer performs recharging only when the battery level becomes less than approximately 95 %, so overcharging is avoided.
- When **[LED]** is set to **[OFF]** on the **[Concealed Mode Configuration]** menu, LED does not light.

*1: When using second battery pack

Charging

When connecting the computer to a power outlet, the battery charging starts automatically.

- The battery pack is not charged when you first purchase it. Be sure to charge it before using for the first time.

Checking the Remaining Battery Power

To check the remaining battery power on the screen

- Click  or  on the task tray.

The remaining battery power is displayed.

Alternatively, you can check the remaining battery power by << Fn >> + << F9 >> key combination. (After signing in to Windows)

- When the battery pack is inserted (example)**

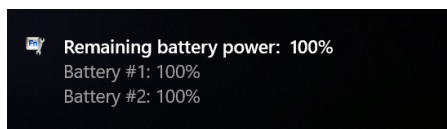
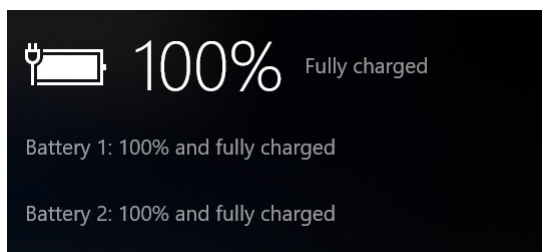

NOTE

- The battery display may not correspond to the actual remaining battery power in the cases as below. To correct the display, perform the Battery Recalibration (→ [Correcting the Battery Display \(Battery Recalibration\)](#)).
 - The battery indicator remains red.
 - The indicator lights orange and the display shows 99 % for a long time.
 - Low battery warning appears soon after a short time of use.

This can occur when the computer is in sleep for a long time without power supply from the AC adaptor.
- The battery display may not be the same as that of task tray. This is not a malfunction.

Computer behavior with low battery

The default settings are as follows.

When the battery level becomes 10 % [Low battery level]	When the battery level becomes 5 % [Critical battery level]
<ul style="list-style-type: none"> ● Displays a message that the battery level is low. <p style="text-align: center;">↓</p>	<ul style="list-style-type: none"> ● The computer enters hibernation. <p style="text-align: center;">↓</p>
Charge the battery.	Connect the AC adaptor or replace the battery to start up the computer.
<ul style="list-style-type: none"> ● Connect the AC adaptor immediately. If you do not have the AC adaptor, exit the running programs and Windows, then confirm that the power indicator is off. ● If you have a fully charged spare battery, turn off the computer, replace the battery and turn the computer on again. 	<ul style="list-style-type: none"> ● Connect the AC adaptor and charge the battery. ● If you have a fully charged spare battery, turn off the computer, replace the battery and turn the computer on again. <p>When the computer enters hibernation with the battery down and you resume the operation without charging the battery, the Windows Resume Loader starts up. Follow the on-screen instructions. After that, however, Windows may not start up normally, or the [Low battery level]/[Critical battery level] function may not work normally.</p>

NOTE

- Battery goes to sleep if the battery level is about 5 %, may be displayed such as “Not exist” or “Not use” is not a malfunction. Please wait for a while to connect the AC adaptor.

Correcting the Battery Display (Battery Recalibration)





The “Battery Recalibration” function measures and memorizes the battery capacity. To correct the battery display, use this function to fill the battery and then discharge it completely. Perform the procedure at least once immediately after purchasing the computer. Normally the interval of battery

recalibration is 3 months.

The battery display may not be correct when the battery pack deteriorates after a long time use. In this case, perform the procedure again.

1. **Connect the AC adaptor.**
2. **Perform "Battery Recalibration".**

You can operate your computer while the battery recalibration is in progress.

1. Click  (Start) -  (Panasonic PC Settings Utility) -  (Support) -  (Battery) - [Perform battery recalibration].
2. Click [OK] on "Perform Battery Recalibration after shutting down Windows." screen.
3. Click [OK] on "Windows will be shut down. OK?" screen.
4. Restart the computer, "Battery Recalibration Utility" is displayed.
5. Press << Enter >> .
6. When the confirmation message appears, select [Yes] and press << Enter >> .

After the battery recalibration is finished, normal charging starts.

NOTE

- When this computer is driven by USB Power Delivery, the battery recalibration cannot be performed.
- The temperature range should be 10 °C to 30 °C {50 °F to 86 °F}.
- Frequent recalibration of the battery can degrade the battery. A caution message appears when the battery recalibration is performed at the shorter interval than approximately a month. In this case, cancel the battery recalibration.
- The battery recalibration may take a long time due to the large battery capacity. This is not a malfunction. (An expected approximate recalibration time is displayed.)
- If the computer is turned off during the battery recalibration (e.g., due to power failure, or accidental removal of the AC adaptor and battery pack), the battery recalibration will not be completed.
- <When performing "Battery Recalibration" after shutting down Windows>
 - Full charge: Approximately 3.0 hours (with Main Battery) / 6.0 hours (with Main Battery + Second Battery)
 - Complete discharge: Approximately 4.5 hours (with Main Battery) / 9.0 hours (with Main Battery + Second Battery)

Battery duration

Note that the computer consumes electricity even when the computer power is off. If the battery pack is fully charged, the battery will fully discharge in the following period of time:

Status	Power On by LAN	Discharge period	
		Main Battery	Main Battery + Second Battery
In modern standby (sleep) When entering into hibernation automatically after 16 hours (factory default)	Deny	Approx. 45 days	Approx. 90 days
In modern standby (sleep) When not entering into hibernation	Deny	Approx. 3 days	Approx. 6 days
In hibernation	Deny	Approx. 8 weeks	Approx. 16 weeks
When power is off	Deny	Approx. 8 weeks	Approx. 16 weeks
	Allow	Approx. 12 days	Approx. 24 days

- The battery duration while the USB port continuous charging function is not used.
- The above value is the holding time at room temperature.

- As factory default, the computer automatically enters the hibernation in 16 hours after it enters the modern standby (sleep) state. This setting is recommended.
- The computer automatically enters the hibernation if the battery level becomes lower than 5 % in the modern standby (sleep) state.
- Since the sleep mode of this computer supports the modern standby mode, the battery consumption in sleep mode is large. Connect the AC adaptor before the battery level becomes zero.

Replacing the Battery Pack

The battery pack is a consumable item so the replacement will be necessary. If the battery operation time becomes noticeably short and not recovered even after recalibrating the battery, replace with a new battery.

IMPORTANT

- The battery pack is not charged when you first purchase it. Be sure to charge it before using for the first time. Charging starts automatically when the AC adaptor is connected to the computer.
- Use only the specified battery pack with your computer.
- If the computer is wet, wipe them off and open the cover. Make sure to dry off the computer, replace/remove the battery pack.

Remove the Battery Pack

When removing the battery pack after turning off the computer

1. **Turn off the computer.**
Do not use the sleep function.
2. **Turn your computer over.**
Make sure no foreign objects are under the computer.
3. **While sliding the latch (A), pull out the battery pack (B).**

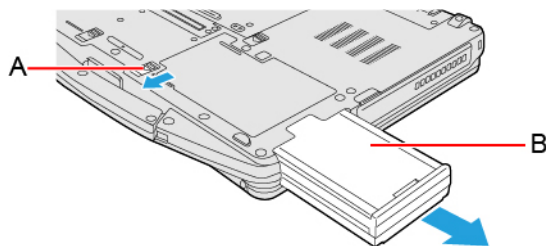

<When using second battery pack>

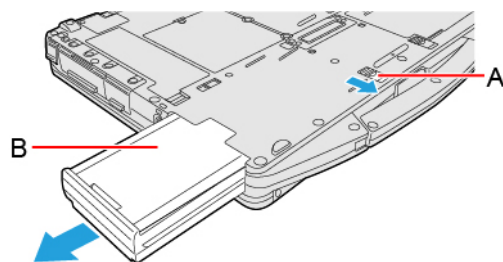

When removing the battery pack without turning off the computer

<When using multiple battery packs>

1. **Turn your computer over.**
Make sure no foreign objects are under the computer.
2. **Slide the latch (C), and check the status of battery indicator (D).**

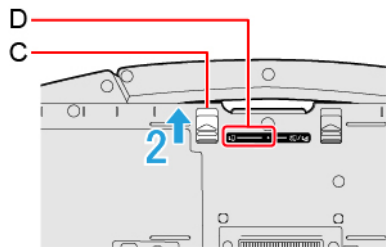

<When using second battery pack>

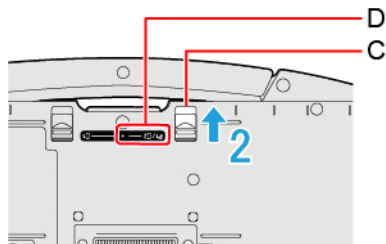

If some one battery has enough remaining power, you can replace the battery pack without turning off and during sleeping the computer.

If a battery indicator lights green, you can replace the battery pack without turning off the computer.

If a battery indicator blinks red, you cannot replace the battery pack without turning off the computer. Turn off the computer before replace the battery pack.

IMPORTANT

- Concealed mode is set to OFF before replacing the battery pack.
- When using two battery packs and replacing one of them, replace it quickly according to the level of batteries in use.

3. While sliding the latch (E), pull out the battery pack (F).

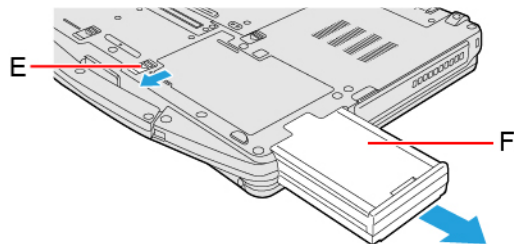

<When using second battery pack>

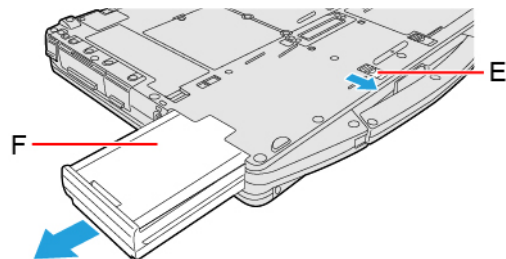

Insert the Battery Pack

IMPORTANT

- Use only the specified battery pack with your computer.
- The battery pack is not charged when you first purchase it. Be sure to charge it before using for the first time. Charging starts automatically when the AC adaptor is connected to the computer.

1. Slide the battery pack in parallel with the arrow direction until it click to the secured position.

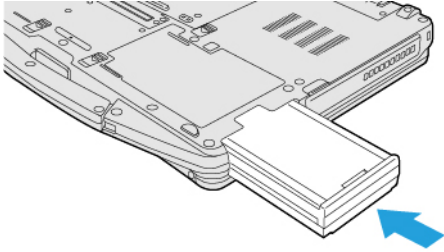

<When using second battery pack>

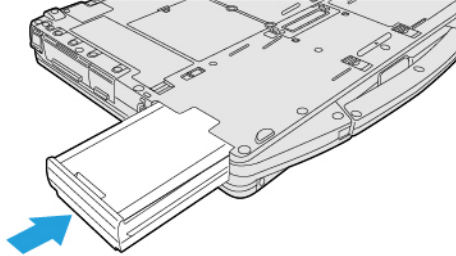

IMPORTANT

- Make sure the latches are securely locked, otherwise the battery pack may fall when you carry the computer.
- Do not remove the battery pack forcibly when the latches are locked. Doing so may damage the battery pack.

Starting Up Your Computer Quickly



The sleep or hibernation functions allow you to shut off the computer without closing programs and documents. You can quickly return to the programs and documents that you were working on before sleep or hibernation.

The sleep mode of this computer supports the modern standby mode.

Function	Recovery time	Power supply
Sleep	Short	Required. (If power is not supplied, all data will be lost.)
Hibernation	Rather long	Not required. (However power is slightly consumed to keep the hibernation.)

Setting Sleep or Hibernation



Sleep

1. Right-click  or  on the task tray, and click [Power Options].
2. Click [Change plan settings] of the power plan you want to change.
3. Select the setting for "Put the computer to sleep", and then click [Save changes].
 - The setting for hibernation may change unexpectedly when you change the setting for sleep. Confirm that the time to enter hibernation is 960 minutes (default setting) or longer (below).

Hibernation

1. After the step 2 of "Sleep" setting (above), click [Change advanced power settings].
2. Double-click [Sleep], and double-click [Hibernate after].
3. Click the item and select the setting.
4. Click [OK].

Precautions

- Connect the AC adaptor if the computer will be in sleep for a long period of time. If you cannot use the AC adaptor, use hibernation instead.
- Using sleep or hibernation repeatedly may cause malfunction of the computer. To stabilize computer operation, restart Windows regularly (about once a week) without using sleep or hibernation.
- Save the necessary data.
- Close files you have opened from removable disks and network drives.
- Do not enter sleep or hibernation in the conditions below, otherwise the data or file may be corrupted, sleep or hibernation may not work, or malfunction may occur in the computer or the peripheral devices.
 - When the extended desktop function is activated.
 - When any of the microSD Memory Card indicator  and the drive indicator  are on.
 - When playing/recording audio files or displaying motion video such as MPEG files.
 - When playing a DVD-Video. (only for model with optical disc drive)
 - When writing to a disc. (only for model with optical disc drive)
 - When using communication software or network functions.
 - When using peripheral devices.

If the computer fails to work normally, restart the computer.

- The password you set in the Setup Utility will be requested upon resuming from hibernation (but not from sleep) or fast startup, if [Password On Resume] is set to [Enabled] in the [Security] menu of the Setup Utility. To disable it, set [Password On Resume] to [Disabled].

The [Password On Resume] setting is valid when you shut down the computer by clicking  (Start) - [Power] - [Shut down].

- It may take 1 or 2 minutes to enter hibernation. Do not touch any key though the screen becomes dark.

IMPORTANT

The following problems will occur when you fail the password input (failing three times or leaving the computer unattended for one minute or more) while resuming from sleep or hibernation.

- Failing the password input while resuming from hibernation:
 - Cannot resume from hibernation by the Task Scheduler or the operation to open the display.

Entering/Resuming from Sleep or Hibernation

To enter sleep or hibernation

In order to enter sleep or hibernation by following procedure, change the power option settings first so that the “Power and sleep buttons and lid settings” operation is set to sleep or hibernation. ( [Setting Sleep or Hibernation](#))

Using hardware functions

1. Close the display, or press the power switch (A).
Sleep: The power indicator (B) blinks green.
Hibernation: The power indicator (B) goes off.

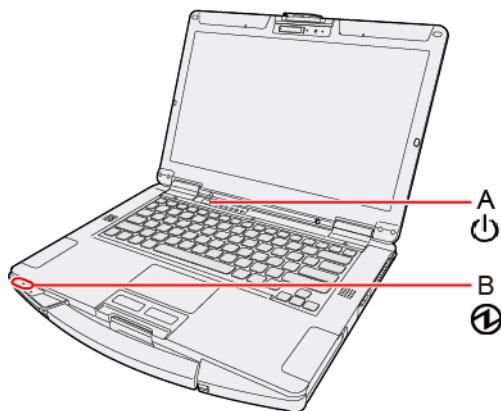

Using «Fn» + «F7»

You can also enter sleep using «Fn» + «F7».

( [Key Combinations](#))

Using Windows function



You can alternatively enter sleep using Windows function.

1. Click  (Start) -  (Power).
2. Click [Sleep].

Closing the display

NOTE

- Hibernation from the Windows system menu is not available as the factory default. To enter hibernation from the Windows system menu, the following setting is necessary.

-
1. Right-click  or  on the task tray, and click [Power Options].
 2. Click [Choose what the power buttons do] - [Change settings that are currently unavailable].
 3. Add check mark for [Hibernate] and click [Save changes].
-

IMPORTANT

While the computer is entering sleep or hibernation

- **Do not:**
 - Touch the keyboard, touchpad, touchscreen (only for model with touchscreen), or power switch.
 - Use an external mouse or other peripheral devices.
 - Connect or disconnect the AC adaptor.
 - Close or open the display.
 - Insert and remove the microSD Memory Card.

Wait until the power indicator blinks green (sleep) or goes off (hibernation).

- **It may take 1 or 2 minutes to enter sleep or hibernation. Do not touch any key though the screen becomes dark.**
- **After releasing the power switch, do not operate it until the power indicator blinks or goes off.**

If you press and hold the power switch for longer than 4 seconds, the computer will forcibly shut down.

Unsaved data will be lost regardless of which option is selected under the "Control Panel" - [Hardware and Sound] - [Power Options] - [Choose what the power buttons do] - "When I press the power button".

In sleep or hibernation

- **Do not attach or remove peripheral devices. Doing so may cause malfunction.**
- **Power is consumed in sleep.**

When power is exhausted, the data retained in memory will be lost. Connect the AC adaptor when the computer is in the sleep function for a prolonged time.

To resume from sleep or hibernation

1. Open the display, press the power switch (A) or touch the keyboard, touchpad or fingerprint reader to resume.

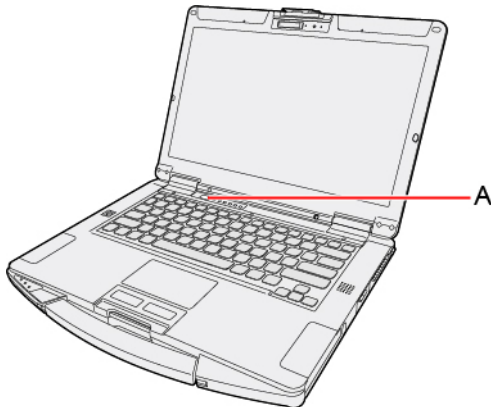

IMPORTANT



- **Do not perform the following operations until resuming is complete. After the display is resumed, wait approximately 15 seconds (normally) or 60 seconds (when the computer is on a network).**
 - Touch the keyboard, touchpad, touchscreen (only for model with touchscreen), or power switch.
 - Use an external mouse or other peripheral devices.
 - Connect or disconnect the AC adaptor.
 - Close or open the display.
 - Shut down or restart Windows.
-

- Enter sleep or hibernation.
- Insert and remove the microSD Memory Card.
- If the computer enters sleep while a USB keyboard or mouse is connected, touching the USB keyboard keys or mouse may resume the computer.

Setting the password input to resume from sleep or hibernation



NOTE

- Set the password beforehand. ( [Setting the Windows Password](#))

1. Sign in to Windows as an administrator.
2. Click  (Start) -  (Settings).
3. Click [Accounts] - [Sign-in options].
4. Select [Every Time] under "Require sign-in".

Ignition Mode



You can turn on the computer by connecting the AC adaptor.

1. Click  (Start) -  (Settings) - [Update & Security] - [Recovery].
2. Click [Restart now] under "Advanced startup".
3. Click [Troubleshoot] - [Advanced options] - [UEFI Firmware Settings] - [Restart].
The computer restarts, and the Setup Utility screen appears.
4. Set [Power On AC] to [Enabled] in the [Main] menu.
5. Press « F10 » , select [Yes], and press « Enter » .

Modern Standby

The sleep mode of this computer supports the modern standby mode. The modern standby mode enables emails or SNS applications to be received by connecting to the wireless LAN periodically even in the sleep state. Also, resume performance in modern standby mode is faster. Accordingly, more power is consumed in modern standby mode than in the conventional sleep function. When the computer is driven by the battery, it is recommended to switch the network connection as necessary.

Setting the modern standby mode in battery-driven state

1. Click  (Start) -  (Settings) - [System] - [Power & sleep].
2. Select the item under "Network connection".
Selecting [Never] enables network connection even in the sleep state (battery-driven state).
Selecting [Always] disables network connection in the sleep state (battery-driven state).

NOTE

- To connect to the network in the sleep state, the application you are using needs to support the modern standby mode.
Check with the application provider whether or not the application supports the modern standby mode.
- When resuming from modern standby (sleep), press the power switch.

-
- Even if the computer moves to the modern standby (sleep) state automatically or manually, depending on the OS state or application specifications, the application operation may continue with the display turned off.
 - Unsaved data will be lost if the power supply is cut by removing both the battery pack and AC adaptor in the modern standby (sleep) state.
-

Panasonic PC Settings Utility

You can perform the following operations easily by using the Panasonic PC Settings Utility.

When starting up this application for the first time, connect to the Internet for initial setup. If it is first started up without Internet connection, the initial setup may take time, and several minutes may be required for startup.

Starting Panasonic PC Settings Utility

1. Click  (Start) -  (Panasonic PC Settings Utility).

You can also press **« Fn » + « 1 »** to start Panasonic PC Settings Utility.

The screen to the below appears.

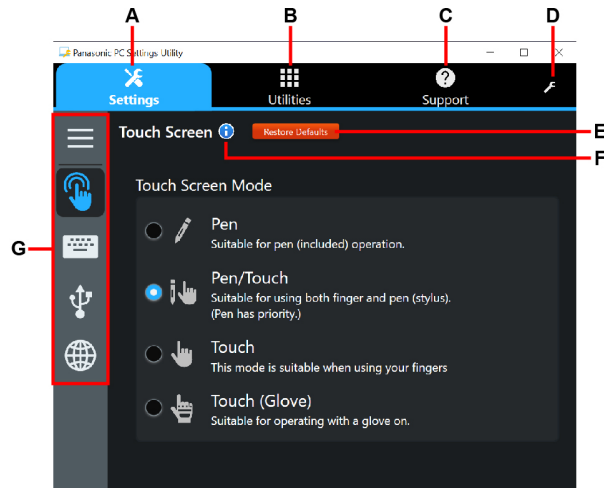

- A. Settings
- B. Utilities
- C. Support
- D. This Application Settings
- E. Restore Defaults

Restore the settings to the default values.

- F. Information
- G. Menu

Display help.

Select the items.

When clicking , name of the items appears.

2. **Make the operation.**

Settings

-  Touch Screen <Only for model with touchscreen>

Touch Screen:

Touch Screen Mode:

( [Change Touch Screen Mode](#))

-  Button / Key

A1/A2/A3/A4 Key:

( [Key Combinations](#))

Fn Key:

( [Hotkey Settings](#))

-  USB

USB Charge Settings:

( [Charging USB Devices](#))

-  Network

Wireless LAN:

( [Wireless LAN](#))



You can use Panasonic applications that display icons. To use these applications, click an icon.



-  Manual

[Launch Manual Selector]

For further information about the computer, you can refer to the on-screen manual.

- Operating Instructions - Reference Manual (This manual)
This manual contains the practical information to help you fully enjoy the computer's performance. Update it to the latest version using network connection.
- Important Battery Tips
The Important Battery Tips will provide you with the battery information so that you can use the battery in the optimum condition to obtain longer operation time.
- Update the on-screen manuals
This describes the procedures to update the on-screen manual.
- Connect to a network
This describes the connection procedures using the network devices mounted on this unit.
- LIMITED USE LICENSE AGREEMENT

-  System

[Launch PC Information Viewer]

( [Checking the Computer's Usage Status](#))

-  Battery

[Perform battery recalibration]

( [Correcting the Battery Display \(Battery Recalibration\)](#))

-  Notification Settings

Urgent Notice



[Settings]

Display the "Emergency notification setting" installation screen.

-  Troubleshooting

Fan control mode:

Set the fan control mode.

-  Recovery Disc Creation
[Launch Recovery Disc Creation Utility]
( [Create a Recovery Disc](#))



This Application Settings

- Themes Settings:
Change the skin of this utility.
- Show/Hide each item:
Click [Administrator settings] to allow you to export or import the show/hide settings.
If "User Account Control" is displayed, click [Yes].

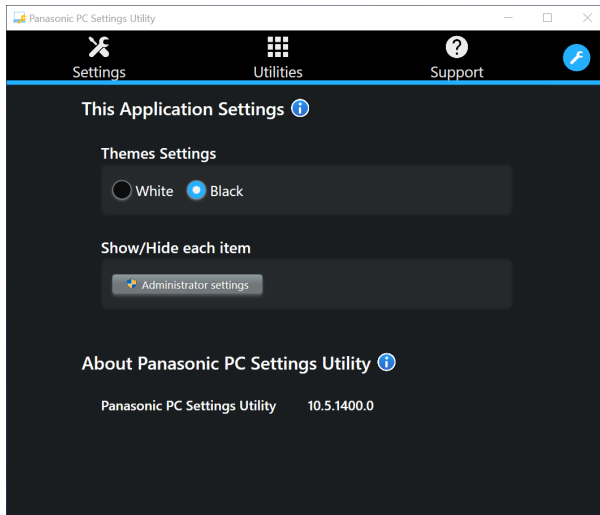

The new settings will be activated after restarting this application.

You can export or import the display items that can be used by XML files on this utility.

About Panasonic PC Settings Utility:

Display the version information.

Connecting LAN

IMPORTANT

- Do not connect the telephone cable to the LAN port.

1. Turn off the computer.

- Do not use sleep or hibernation.

2. Open the cover (A) and connect the cable.

- Connect the LAN port (B) and the network system (server, HUB, etc.) using a LAN cable.

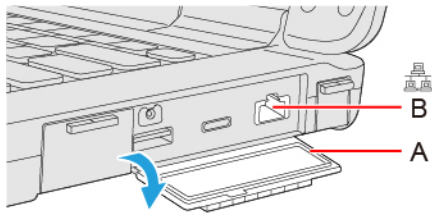

<Only for model with 2nd LAN>

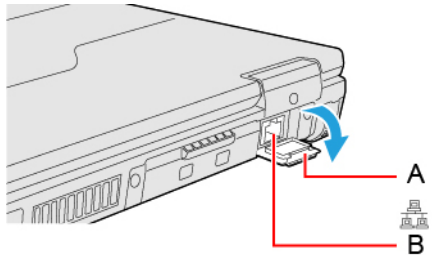

3. Turn on the computer.

Disabling/Enabling Wireless Communication

<Only for model with wireless LAN/2nd wireless LAN/Bluetooth/wireless WAN/GPS on wireless WAN/dedicated GPS>

There are several ways of disabling and enabling wireless communication.

- [Switching the airplane mode using << Fn >>](#)
- [Using airplane mode](#)
- [Turning wireless communication on/off quickly](#)
- [Using Network & Internet settings](#)
- [Setting \[Wireless Configuration\] in the \[Advanced\] menu of the Setup Utility](#)



NOTE

- For further information about [Wireless LAN](#).
- For further information about [Bluetooth](#).
- For further information about [Wireless WAN](#).
- For further information about [GPS](#).

Switching the airplane mode using << Fn >>

1. Press << Fn >> + << F10 >> ( [Key Combinations](#)).

Using airplane mode^{*1}







1. Click  (Start) -  (Settings) - [Network & Internet] - [Airplane mode] ^{*1}.
2. To disable wireless communications, set "Airplane mode"^{*1} to [On].
To enable wireless communications, set "Airplane mode"^{*1} to [Off], and then;
 - set "Cellular" to [On] (for wireless WAN).
 - set "Wi-Fi"^{*1} to [On] (for wireless LAN).
 - set "Wi-Fi 2"^{*1} to [On] (for 2nd wireless LAN).
 - set "Bluetooth" to [On] (for Bluetooth).

*1: Screen messages are explained in [English (United States)].



(Depending on the language preference, some screen messages in these instructions are different from the actual screen messages. For example, [Flight mode]/[Wi-Fi]/[Wi-Fi 2] may be displayed instead of [Airplane mode]/[Wi-Fi]/[Wi-Fi 2] in some language preference.)

Turning wireless communication on/off quickly

Turning on/off the Wi-Fi

1. Click  on the task tray.
2. To turn off the Wi-Fi, click  ^{*2} (Wi-Fi).
The icon changes to , and then the icon  on the task tray changes to .
- To turn on the Wi-Fi, click . Then the icon changes to .

Turning on/off the airplane mode*2

1. Click  on the task tray.
2. To turn on the airplane mode, click  (Airplane mode).

The icon changes to , and then the icon  on the task tray changes to .

To turn off the airplane mode, click . Then the icon changes to .

*2 : Screen messages are explained in [English (United States)].

(Depending on the language preference, some screen messages in these instructions are different from the actual screen messages. For example, [Flight mode]/[Wi-Fi]/[Wi-Fi 2] may be displayed instead of [Airplane mode]/[Wi-Fi]/[Wi-Fi 2] in some language preference.)

Using Network & Internet settings

1. Click  on the task tray.
2. Click [Network & Internet settings].
“Network & Internet” screen appears.
3. Click the menu “Wi-Fi”*3, “Cellular” or “Airplane mode”*3, and turn on/off each wireless function.

*3 : Screen messages are explained in [English (United States)].

(Depending on the language preference, some screen messages in these instructions are different from the actual screen messages. For example, [Flight mode]/[Wi-Fi]/[Wi-Fi 2] may be displayed instead of [Airplane mode]/[Wi-Fi]/[Wi-Fi 2] in some language preference.)

Wireless LAN

<Only for model with wireless LAN/2nd wireless LAN>

IMPORTANT

- **Do not use wireless LAN on airplanes, in hospitals, or in other locations where wireless LAN signals may affect devices.**
Follow the instructions of airline companies and hospitals. If you use the computer in these locations, turn off the wireless LAN.
- **To avoid unauthorized access to the computer through wireless LAN.**
We recommend you to make security settings such as encryption before using wireless LAN.
Otherwise the disk data such as the shared files can be exposed to the risk of unauthorized access.

NOTE

- Communication is established through the wireless LAN antenna (A) and 2nd wireless LAN antenna (B). Do not block the antenna area with your hand or body.

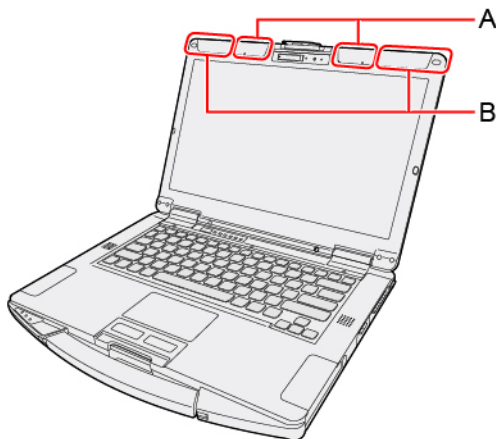

- When you connect this computer to a port replicator compatible with external antenna, you can switch the internal antenna to the external antenna, or vice versa.
- The transmission rate will be lower when a microwave oven is used near by.
- To use wireless LAN, set [Wireless LAN]/[Wireless LAN (2nd)] to [Enabled] (default) in the sub-menu of [Wireless Configuration] in the [Advanced] menu of the Setup Utility.

Using the Wireless LAN Function

Before using a wireless LAN, turn the wireless LAN communication on.



Turning on/off the wireless LAN communication

1. To enable the wireless communication ( [Disabling/Enabling Wireless Communication](#)).

Setting the wireless LAN access point

Preparation

Follow the instruction manual of the wireless LAN access point to make settings for the access point to recognize the computer.

1. Turn the wireless LAN on.
2. Click  or  on the task tray.
3. <Only for model with 2nd wireless LAN>
Click  at upper of access point displayed, and select then [Wi-Fi 2].

4. Select an access point, and click [Connect].
5. Input the key you set for the access point to recognize the computer, and click [Next].

Wait for the computer to connect to the wireless LAN access point.

When the icon on the task tray is changed to , the wireless LAN setting is complete.

NOTE

- The settings depend on the network environment. For further information, ask the system administrator or the person in charge of the network.
- If you use the stealth type wireless LAN access point which restricts automatic detection of the wireless LAN access point, take the following procedure.

If you do not perform the procedure below, you may not be able to access the wireless LAN access point automatically or the wireless LAN access point may not be displayed.

1. Click  on the task tray, and then click [Hidden network].
2. Click [Connect], enter the necessary information such as the network name (SSID), and click [Next].

For further information, ask the system administrator or the person in charge of the network.

- <Only for model with 2nd wireless LAN>

Using the wireless LAN and 2nd wireless LAN in the same frequency band may cause radio wave interference, resulting in reduction in the communication speed, noise occurrence or connection failure. Set and use different frequency bands between the wireless LAN and 2nd wireless LAN.

Since the occurrence of interference cannot be avoided even if the channels are set with the maximum distance between them in the same frequency band, set and use different frequency bands between the wireless LAN and 2nd wireless LAN as shown below.

We recommend that you use the following settings.

Wireless LAN: 5 GHz

2nd Wireless LAN: 2.4 GHz

Enabling/Disabling the Wireless LAN Standard IEEE802.11a (802.11a)

1. Click  (Start) -  (Panasonic PC Settings Utility) -  (Settings) -  (Network).
2. Click [Enabled] or [Disabled] for the wireless LAN IEEE802.11a.

<Only for model with 2nd wireless LAN>

IEEE802.11a can not be set separately for wireless LAN and 2nd wireless LAN. The setting of the wireless LAN will be reflected.

NOTE

- In some countries, communication using IEEE802.11a (5 GHz wireless LAN) standard is restricted by law.
- If IEEE802.11a is enabled or disabled while the computer is connected to an IEEE802.11b/g access point, the connection will be temporarily interrupted.

Bluetooth

<Only for model with Bluetooth>

You can access internet and other Bluetooth devices without connecting cables.

NOTE

- Communication is established through the Bluetooth antenna (A). Do not block the antenna area with your hand or body.

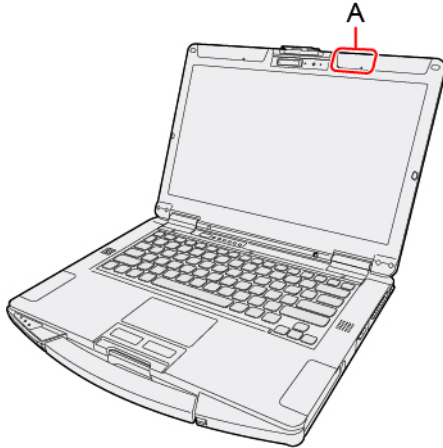



- To use Bluetooth, set [Bluetooth] to [Enabled] (default) in the sub-menu of [Wireless Configuration] in the [Advanced] menu of the Setup Utility.
- The transmission rate will be lower when a microwave oven is used near by.
- When you uninstall the Bluetooth Driver, turn Bluetooth off.

Using the Bluetooth Function

Before using a Bluetooth, turn the Bluetooth communication on.

Turning on/off the Bluetooth communication

1. To enable the wireless communication ( [Disabling/Enabling Wireless Communication](#)).
2. Click  (Start) -  (Settings) - [Network & Internet] - [Airplane mode] ^{*1} , and set "Airplane mode" ^{*1} to [Off].
3. To turn off the Bluetooth communication, set "Bluetooth" to [Off].
To turn on the Bluetooth communication, set "Bluetooth" to [On].

*1 : Screen messages are explained in [English (United States)].

(Depending on the language preference, some screen messages in these instructions are different from the actual screen messages. For example, [Flight mode] may be displayed instead of [Airplane mode] in some language preference.)

To check the Bluetooth communication status

1. Click  (Start) -  (Settings) - [Devices] - [Bluetooth & other devices].

NOTE

- You can also clicking  on the task tray, and then click  (Bluetooth Devices) - [Show Bluetooth Devices] to check the communication status.

<Only for model with wireless WAN>

NOTE

- Communication is established through the Wireless WAN antenna (A). Do not block the antenna area with your hand or body.

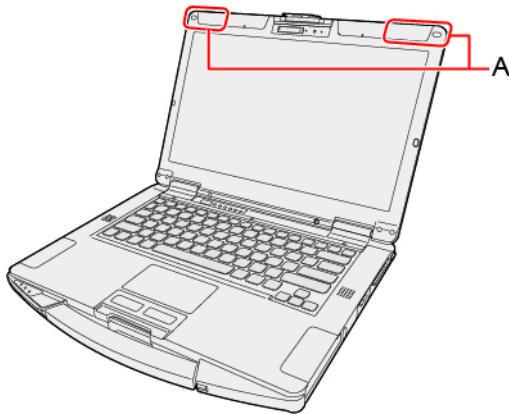

- To use wireless WAN, set [Wireless WAN] to [Enabled] (default) in the sub-menu of [Wireless Configuration] in the [Advanced] menu of the Setup Utility.
- If “Device driver software was not installed correctly.” (or a similar message) appears when starting the computer or resuming from sleep or hibernation.
 - When communication works normally, Wireless WAN is operating correctly.
 - If communication fails, the device may not be recognized correctly. In this case, restart the computer.
- Do not use the nanoSIM card adapter.
- Do not insert nanoSIM cards on which labels or stickers are affixed. Failure to obey may result in malfunction.

Inserting/Removing a nanoSIM Card

Before using the Wireless WAN, set a nanoSIM card to the nanoSIM card slot.

IMPORTANT

- Be sure to turn off the computer before inserting or removing the nanoSIM card.

To insert a nanoSIM card

1. Turn off the computer.
2. Disconnect the AC adaptor, remove the battery pack. ([▶ Replacing the Battery Pack](#))
<When using second battery pack>
 - Remove the second battery pack. ([▶ Replacing the Battery Pack](#))
3. Open the cover (A).
4. Remove the screw (B) and the nanoSIM card slot cover (C).

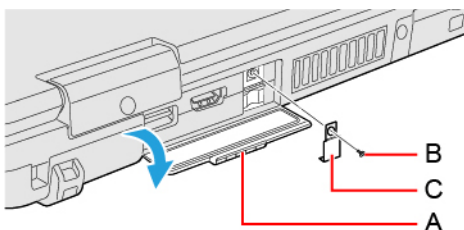

5. Insert the nanoSIM card (D) into the nanoSIM card slot with the contact side (E) facing downward and with the cut corner oriented as

shown in the illustration.

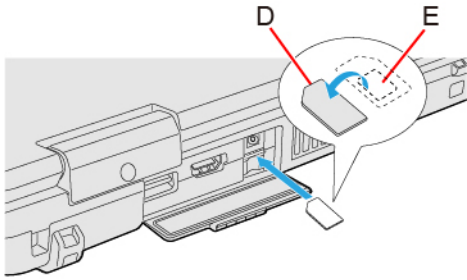

IMPORTANT

- Do not insert the nanoSIM card upside down.

- Close the nanoSIM card slot cover (C), attach it and tighten the screw (B) firmly.

Use the PH 1 (PH #1) screwdriver.

The screw used is 1.

Recommended tightening torque

0.45 N•m \pm 0.05 N•m (4.5 kgf•cm \pm 0.5 kgf•cm)

- Close the cover (A).

- If the cover is not closed, the nanoSIM card may jump out when the computer falls.

- Insert the battery pack and connect the AC adaptor.

To remove a nanoSIM card

- Turn off the computer.

- Disconnect the AC adaptor, remove the battery pack. ([▶ Replacing the Battery Pack](#))

<When using second battery pack>

- Remove the second battery pack. ([▶ Replacing the Battery Pack](#))

- Open the cover (F).

- Remove the screw (G) and the nanoSIM card slot cover (H).

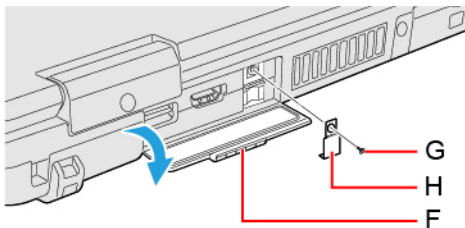

- Push the nanoSIM card.

It will come out of the slot a little bit.

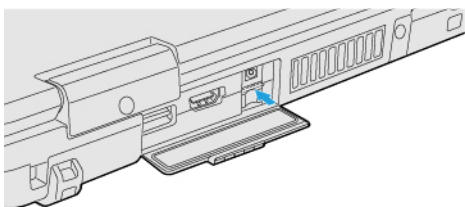

- Pull the card all the way out.

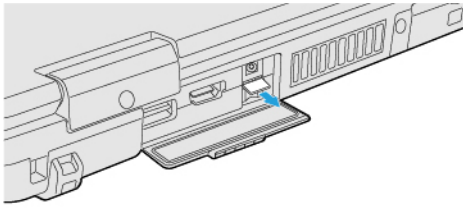

7. **Close the nanoSIM card slot cover (H), attach it and tighten the screw (G) firmly.**
Use the PH 1 (PH #1) screwdriver.
The screw used is 1.

Recommended tightening torque
0.45 N•m ± 0.05 N•m (4.5 kgf•cm ± 0.5 kgf•cm)

8. **Close the cover (F).**
9. **Insert the battery pack and connect the AC adaptor.**

Connect/Disconnect to a network



Connecting to a network

If the APN setting is completed automatically after inserting the nanoSIM card, Internet connection will be possible.

In such cases, the following settings are not necessary.

Adding an APN

If Internet connection via wireless WAN is not possible, perform the following to add an APN.

1. Click  (Start) -  (Settings) - [Network & Internet].
2. Click [Cellular].
3. Click [Advanced options].

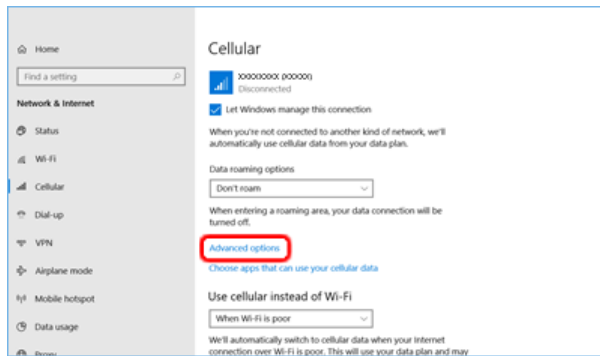

4. Click [Add an APN].

XXXXXXX (XXXXX)

work differently to reduce data usage when you're connected to this network.

Set as a metered connection

On

If you set a data limit, Windows will set the metered connection setting for you to help you stay under your limit.

Set a data limit to help control data usage on this network

APN settings

Choose the default Internet APN

Automatic

We'll automatically use the best Internet APN we found. We won't use an APN that you or your organization might have created.

+ Add an APN

Internet APN

(*) Default APN Applied

5. Input detailed information such as APN, and then click [Save].

APN

Profile name

APN

User name

Password

Type of sign-in info

None

IP type

Default

APN type

Internet



Apply this profile

Save

6. Click [OK].
Internet connection will be possible.
7. If you are not connected to the Internet, select created APN profile, and then click [Apply].

NOTE



- When "Use cellular instead of Wi-Fi" is set to [When Wi-Fi is poor] (default), wireless WAN connections will be established only when there is no Internet connection via Wi-Fi.
- When using wireless WAN, perform the following to disable Airplane mode^{*1}.

1. Click  (Start) -  (Settings) - [Network & Internet] - [Airplane mode] .
2. Set "Airplane mode"*1 to [Off].
3. Set "Cellular" to [On].

*1: Screen messages are explained in [English (United States)].

(Depending on the language preference, some screen messages in these instructions are different from the actual screen messages. For example, [Flight mode] may be displayed instead of [Airplane mode] in some language preference.)

Disconnecting to a network

1. Click  (Start) -  (Settings) - [Network & Internet] - [Cellular].
2. Click [Disconnect].

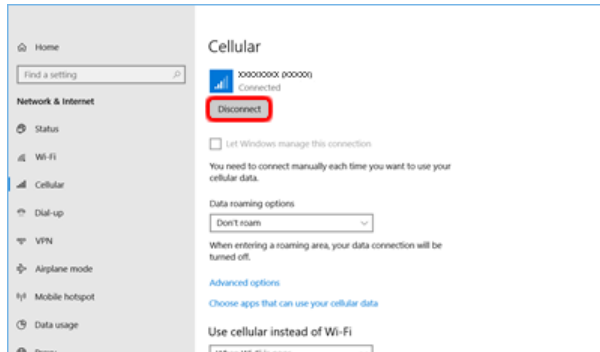

NOTE

- You can also click  on the task tray, and then click [Disconnect].

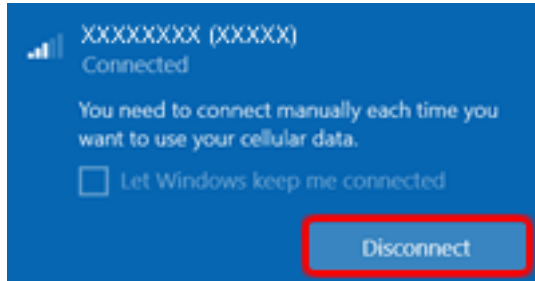

GPS

<Only for model with dedicated GPS / GPS on wireless WAN>

This computer has the GPS function with the wireless WAN module, and the dedicated GPS function.

For the differences, refer to the table below.

Devices	Device name	Support system
GPS on wireless WAN	EM7511/EM7455/EM7430	GPS / GLONASS / BeiDou
Dedicated GPS	U-blox8 (M8N)	GPS / GLONASS / SBAS

GPS information can be checked using the "Panasonic PC GPS Viewer".

To use the "Panasonic PC GPS Viewer", proceed the following operation.

1. Click  (Start) -  (Panasonic PC GPS Viewer).

You can start up "Panasonic PC GPS Viewer" from Panasonic PC Settings Utility. Launch Panasonic PC Settings Utility, and then click 

(Utilities) -  (GPS Viewer).

NOTE

- **Communication is established through the GPS antenna (A). Do not block the antenna area with your hand or body.**

<Only for model with dedicated GPS>

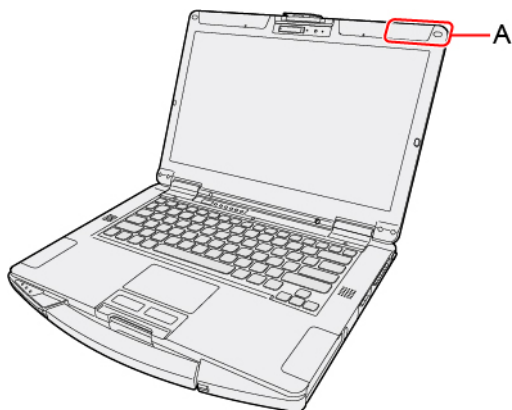

<Only for model with GPS on wireless WAN>

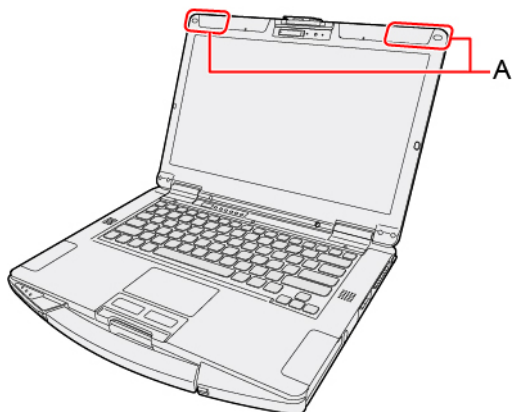

- **When the u-blox Virtual COM Port is included in Ports (COM & LPT) under Device Manager, the following ports cannot be used.**

Sierra Wireless Snapdragon™ X16 LTE-A NMEA Port



Saving Power

You can extend battery life and save power also during AC adaptor usage.

Reducing Power Consumption

Use the methods below to reduce power consumption.

- **Change the Power mode to “Best battery life”.**

1. Click  or  on the task tray.
2. Move the “Power mode” slider  to the left to set the “Power mode” to “Best battery life”.

- **Press «Fn» + «F1» to reduce LCD brightness.**

Reducing internal LCD brightness will reduce power consumption.

Furthermore power saving options:

- **Turn off the computer when it is not in use.**

You can also turn off only the wireless LAN or wireless WAN power.

- **Disconnect external devices (USB devices, external mouse, etc.) that are not being used.**

- **Use Sleep.**

Press «Fn» + «F7» to set the computer to sleep when you have to leave the computer.

This shuts down computer operation to reduce power consumption.



- **When using the battery, do not use applications that place a significant load on the CPU.**

Some application software may place a large burden on the CPU only with start-up and may consume power.

- **When you are using the screen saver with 3D graphics, change to another screen saver.**

To change the screen saver, right-click the desktop, click [Personalize] - [Lock screen] - [Screen saver settings] and click the title of the screen saver.



Configuring Power Saving Settings

1. Click  or  on the task tray.
2. Use the slider under “Power mode”, and select the setting.



Customizing the Power Setting

You can choose the optimum power setting for your operating condition by selecting a power plan. You can also create your own power plan.



Changing the Power Plan Setting

1. Right-click  or  on the task tray, and click [Power Options].
2. Click [Change plan settings] of the power plan you want to change.
3. Change the settings.
 - [Change advanced power settings]: You can make more detailed settings.
4. Click [Save changes].

Creating Your Own Power Setting

1. Right-click  or  on the task tray, and click [Power Options].
2. Click [Create a power plan], click the basic plan and input the name of power plan.
3. Click [Next].
4. Change the settings and click [Create].
 - To change the settings or to make more detailed settings. ( [Changing the Power Plan Setting](#))

Deleting the Power Plan

1. Right-click  or  on the task tray, and click [Power Options].
2. Click [Change plan settings] of the power plan you wish to delete.
If the power plan you wish to delete is already selected, select another plan first.
3. Click [Delete this plan], and then click [OK] on the confirmation screen.

Security Measures

Use these features to protect your data.

Setting the Supervisor Password/User Password

Set the Supervisor Password before setting the User Password.

1. Start up the Setup Utility. ( [Starting the Setup Utility](#))
2. Select [Security].
3. Select [Set Supervisor Password] or [Set User Password], and press << Enter >> .
4. Enter your password in [Create New Password] and press << Enter >> .
 - When the password has been set, you need to enter your password in [Enter Current Password] and press << Enter >> .
 - To disable the password, leave the input field empty and press << Enter >> .
5. Enter your password again in [Confirm New Password] and press << Enter >> .
6. Press << F10 >> , and then click [Yes].

IMPORTANT

- Do not forget your password. If you forget your Supervisor Password, you will not be able to use your computer. Contact Panasonic Technical Support.
- When running the Setup Utility, do not leave and go away from your computer even for a short time, since other people may set or change the password.



NOTE

- The password will not be displayed on the screen.
- If the [Caution] screen appears when entering the password, check the status of NumLock and Caps Lock.
- You can use up to 32 alphanumeric characters (including spaces).
 - The case (upper/lower) is distinguished.
 - Use only the upper horizontal row of numeric keys to input your password.
 - You cannot use << Ctrl >> to input a password.
- Disabling the Supervisor Password also disables the User Password.

Setting the Windows Password

To set the password, proceed as follows.

The Windows password will be applied when you sign in to Windows, or resume the computer from the Lock screen.

1. Click  (Start) -  (Settings) - [Accounts] - [Sign-in options].
2. Click [Add] under "Password".



IMPORTANT

- Check the status of NumLock and Caps Lock.

NOTE

- Set the key entry mode to English ("ENG") and enter characters.

The keyboard layout can be added or changed in the following steps.

1. Click  (Start) -  (Settings) - [Time & Language] - [Language].
2. Click a language and click [Options].
3. Click [Add a keyboard] and choose a keyboard from the list.

- **Remember your password. If you forget the password, you cannot use Windows. Creating a password reset disk beforehand is recommended.**

Preventing Your Computer from Unauthorized Use

You can set a start-up password to protect your computer from unauthorized use.

1. **Set the password ( [Setting the Supervisor Password/User Password](#)), and select [Enabled] in [Password On Boot] and/or [Password On Resume] in the [Security] menu of the Setup Utility.**

NOTE

- The [Password On Resume] of Setup Utility is effective when the computer was once shut down, and not effective when the computer resume from sleep.
- If the Supervisor Password or User Password has been set, the password input screen will be displayed on starting-up of the Setup Utility even though [Password On Boot] and/or [Password On Resume] is set to [Disabled]. If you set [Password On Boot] to [Enabled] and set [Password on Reboot] to [Same as Boot], password input will also be required at Windows restart. ([Same as Boot] is the default setting.)

Preventing Your Flash Memory Drive from Being Read or Written

The flash memory lock function protects the flash memory data from being read or written by removing the flash memory from the computer. (Note that the flash memory lock does not guarantee complete protection of the data.)

1. **Select [Enabled] in [Hard Disk Lock] in the [Security] menu of the Setup Utility.**

IMPORTANT

- For the data being read/written on the original computer, the Setup Utility settings must be the same as when the flash memory drive was removed.
- You cannot use the flash memory lock function without setting the Supervisor Password. Set the Supervisor Password beforehand ( [Setting the Supervisor Password/User Password](#)).
- When you have your flash memory drive repaired.
 - Contact Panasonic Technical Support.
 - Before sending back the flash memory drive, be sure to set the [Hard Disk Lock] to [Disabled].

NOTE

- The flash memory lock function works with the built-in flash memory. It does not work with the external hard disk.
- We recommend you to set [Password On Boot] to [Enabled] to ensure security though it is not required to enable the flash memory lock.
- Note that the flash memory lock does not guarantee complete protection of the data.

<Only for model with optical disc drive> Disabling Optical disc drive

Disable optical disc drive (optional) operation to prevent the drive from being read/written and from being used to start the computer.

1. Select [Disabled] in [Optical Drive] in the [Advanced] menu of the Setup Utility.

NOTE

- This does not work for commercially available optical drive.

Disabling USB Devices

Disable USB flash Memory operation to prevent the drive from being read/written and from being used to start the computer.

You can protect your data from unauthorized access or accidental overwriting.

1. Select [Disabled] in [USB Port and Port Replicator]/[Legacy USB Support] in the [Advanced] menu of the Setup Utility.

<Only for model that supports TPM>

Device encryption

Using device encryption can protect folders or files from illegal accesses in the case the computer is lost or stolen. This computer supports the "Device encryption" function. This function is set to on as factory default, however, the encryption is not completed yet. To complete the encryption, you need to sign in with your "Microsoft account". Follow the instruction of the system administrator to complete the setting.

NOTE

- When you execute [Create a system image] while signed into your Microsoft account with "Device encryption" enabled, the "You have chosen to back up drive c: which is encrypted. The backup location will not be encrypted. Make sure the backup is kept in a physically secure location." warning message may appear.

When attempting to recover a backup created under the above conditions, the "System Image Recovery" screen will appear and entry of the recovery key will be required. In such cases, use the recovery key that you previously printed or saved to a file, or perform the following to acquire the recovery key.

1. Access the "<http://go.microsoft.com/fwlink/p/?LinkId=237614>" URL on a device connected to the Internet (e.g., another computer or tablet), and sign into your Microsoft account.

If multiple recovery keys are displayed, acquire the recovery key for the key ID that appears on the "System Image Recovery" screen.

- Backups created with [Create a system image] are not encrypted. Physically store the media on which the backup is stored in a safe location.
- The backup recovery procedure will complete when you connect to the Internet, and a new recovery key will be created at that point.
- Additionally, entry of the recovery key will be required when restoring restore points or during startup in safe mode, for example. In such cases, perform the above procedure to acquire the recovery key.

Other security measure

● About Secure Boot

"Secure Boot" is a function that protects your computer by prohibiting Operating System other than those permitted under factory default conditions from being executed during startup.

When performing [Clear Secure Boot Keys] to use Secure Boot.

<When using the function of Microsoft_DeviceGuard/CredentialGuard>*1

- Select [Install default Secure Boot keys (Device Guard Ready)].

<When not using the function of Microsoft_DeviceGuard/CredentialGuard>

- Select [Install default Secure Boot keys].

For further information, ask the system administrator.

*1 : It is not supported by the factory OS.

● About TPM

<Only for model that supports TPM>

TPM (Trusted Platform Module) is a security chip aimed at high level cryptographic processing and secure storage of encryption keys (ex. BitLocker Drive Encryption).

In the file encryption using the TPM, encryption keys can be stored on a TPM chip separated from the internal disk. This will allow you to increase the security level.

To use the TPM function, perform the following steps.

For more information about the usage, follow the instructions by a system administrator.



1. Click  (Start) - [Windows System] - [Control Panel] - [System and Security] - [BitLocker Drive Encryption].
2. Click [TPM Administration].

• Windows Hello

This function is used to sign in to Windows quickly, or perform individual authentication.

<Only for model with camera with IR sensor>

The face recognition for Windows Hellos is supported. To use Windows Hellos, perform the following steps for setup.

1. Click  (Start) -  (Settings).
2. Click [Accounts] - [Sign-in options].
3. Click [Set up] under the "Windows Hello".
4. Follow the on-screen instructions.

NOTE

- To use Windows Hellos, you need to set the password and PIN for sign-in options.
- During face recognition, the IR sensor camera light turns on, and becomes hot. Do not touch the IR sensor section when the light is on, and shortly after the light turns off.

Concealed Mode

You can make your computer inconspicuously using the concealed mode.

You can select on/off of LCD backlight, LED, Sound, Wireless Radio and Backlit Keyboard.

IMPORTANT

- Concealed Mode is enabled as the factory default.
- The camera indicator cannot be turned off.

Switching the concealed mode

1. Press **«Fn» + «F8»** ( [Key Combinations](#)).

NOTE

- If you press keys in succession, the Concealed Mode may not be switched. More than 4 seconds interval is necessary to switch on/off.

Disabling/Enabling the concealed mode

This function is effective when the computer is restarted.

1. Set [\[Concealed Mode\]](#) to **[Enabled]** or **[Disabled]** in the sub-menu of [\[Concealed Mode Configuration\]](#) in the **[Main]** menu of the Setup Utility.

Change the settings

This function is effective when the computer is restarted.

1. You can change the devices turned on/off in [\[Concealed Mode Configuration\]](#) with Setup Utility. You can change the trigger key in [\[Trigger Key\]](#).

NOTE

- **«Fn» + «F8»** key is always enabled.
- When set **[LCD Backlight]** to **[Minimum]** and **[LED]** to **[ON]**, the LED may become dark.

Starting Panasonic PC Day Night Mode Utility

1. Click  (Start) -  (Panasonic PC Day Night Mode Utility).

The Panasonic PC Day Night Mode Utility starts up, and the following screen is displayed.

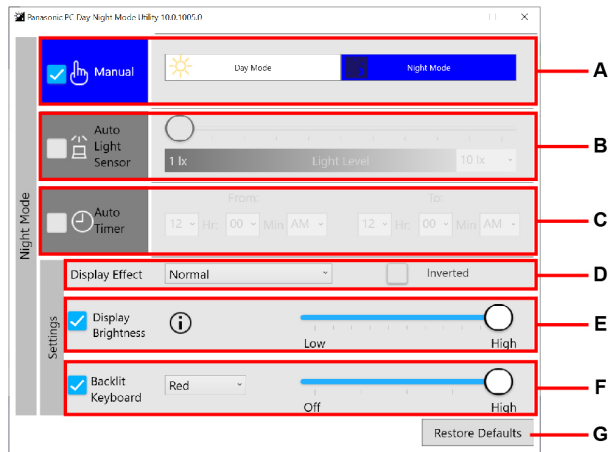



- A. Manual**
Switch between [Day Mode] and [Night Mode].
When [Manual] of “Panasonic PC Day Night Mode Utility” is selected, « Fn » + « 3 » is enabled.
- B. Auto Light Sensor <Only for model with camera>**
Set the brightness to automatically switch to the Night Mode.
- C. Auto Timer**
Specify the time period to switch to the Night Mode.
- D. Display Effect**
Change the color of display.
Color is inverted when you add a check mark to [Inverted].
- E. Display Brightness**
Change the brightness of the display screen.
If you remove the check mark, the settings will not be reflected.
- F. Backlit Keyboard <Only for model with backlit keyboard>**
Change the brightness and color of the Backlit Keyboard.
If you remove the check mark, the settings will not be reflected.
- G. Restore Defaults**
Return all the settings to the default values.

NOTE

- When using the “Panasonic PC Day Night Mode Utility”, confirm that “Night light” is set to [Off].



You can check with the following procedure.

1. Click  (Start) -  (Settings) - [System] - [Display].
2. Set “Night light” to [Off], and remove the check mark from [Change brightness automatically when lighting changes] under “Brightness and color”.

Setup Utility

You can make the settings of the computer's operating environment (password settings, startup drive selection, etc.)

Starting the Setup Utility

1. Click  (Start) -  (Settings) - [Update & Security] - [Recovery].
2. Click [Restart now] under "Advanced startup"*1.

*1: Screen messages are explained in [English (United States)].

(Depending on the language preference, some screen messages in these instructions are different from the actual screen messages. For example, [Advanced start-up] may be displayed instead of [Advanced startup] in some language preference.)

3. Click [Troubleshoot] - [Advanced options] - [UEFI Firmware Settings] - [Restart].

The computer restarts, and the Setup Utility screen appears.

When [Enter Password] is displayed, enter your password.

When you start the Setup Utility with Supervisor Password

- You can make the settings of all items of the Setup Utility.

When you start the Setup Utility with User Password

- Note the following:
 - In the [Advanced] and [Boot] menus, you cannot make the settings of all items.
 - In the [Security] menu, you can change only the User Password when [User Password Protection] is set to [No Protection]. You cannot delete the User Password.
 - In the [Exit] menu, you cannot make the setting of [Load Default Values] and [Boot Override].

NOTE

- Setup Utility screen is displayed on the internal LCD even when an external display is connected to the computer as the factory default. However, if the LID (display) is closed, it will come to be displayed on an external display.

Information Menu

Underlined items are the factory presets.

Language	<u>English</u> French Japanese
----------	--------------------------------------

Product Information

Model No Serial No	Computer information (cannot be changed.)
▶ Expansion Areas	Enter the sub-menu.

Sub-menu (Expansion Areas)

Rear Expansion Area Model No Serial No	Computer information (cannot be changed.)
--	---

Front Expansion Area Model No Serial No	Computer information (cannot be changed.)
---	---

TOUGHBOOK Universal Bay Model No Serial No	Computer information (cannot be changed.)
--	---

Option Configuration ID	Computer information (cannot be changed.)
-------------------------	---

System Information

Processor Type Processor Speed Memory Size Available Memory Hard Disk	Computer information (cannot be changed.)
---	---

BIOS Information

BIOS BIOS Configuration Embedded Controller Intel(R) ME Firmware Accumulative Operating Time Access Level	Computer information (cannot be changed.)
--	---

Main Menu

Underlined items are the factory presets.

System Date <ul style="list-style-type: none"> Day of the Week, Month/Day/Year. You can use « Tab » to move the cursor. 	[xxx xx/xx/xxxx]
System Time <ul style="list-style-type: none"> 24-hr. style. You can use « Tab » to move the cursor. 	[xx:xx:xx]

Main Configuration

Touch Pad	Disabled <u>Enabled</u>
10-Key Mode <ul style="list-style-type: none"> Select the behavior of the 10-key area of the keyboard. When [NumLock] is selected, the 10-key area works as a number pad when NumLock LED is on. When [Fn Key] is selected, the 10-key area works as a number pad when the « Fn » key is held, and NumLock LED is on. 	<u>NumLock</u> Fn Key
Battery Charging Indicator	<u>On Continuous</u> Flashing

Power On AC	<u>Disabled</u> Enabled
LID Switch	Disabled <u>Enabled</u>

▶ Concealed Mode Configuration	Enter the sub-menu.
<ul style="list-style-type: none"> The sub-menu appears when this item is selected. 	

Sub-menu (Concealed Mode Configuration)

Concealed Mode	Disabled <u>Enabled</u>
----------------	----------------------------

LCD Backlight	OFF <u>Minimum</u> ON
<ul style="list-style-type: none"> Can be changed only when [Concealed Mode] is set to [Enabled]. 	

LED	<u>OFF</u> ON
<ul style="list-style-type: none"> Can be changed only when [Concealed Mode] is set to [Enabled]. Except for the camera indicator and the LED of external devices. 	

Sound	<u>OFF</u> ON
<ul style="list-style-type: none"> Can be changed only when [Concealed Mode] is set to [Enabled]. 	

Wireless Radio	OFF <u>ON</u>
<ul style="list-style-type: none"> Can be changed only when [Concealed Mode] is set to [Enabled]. 	

Backlit Keyboard	OFF <u>ON</u>
<ul style="list-style-type: none"> Only for model with Backlit Keyboard. Can be changed only when [Concealed Mode] is set to [Enabled]. 	

Trigger Key	<u>Fn+F8</u> F8
<ul style="list-style-type: none"> Can be changed only when [Concealed Mode] is set to [Enabled]. Select the key combination to turn on/off the Concealed Mode. When [F8] is selected, pressing « F8 » turns on/off the Concealed Mode. 	

▶ Fan Diagnostics	Enter the sub-menu. Press « Enter » to start fan test.
-------------------	---

▶ USB Charge Settings	Enter the sub-menu.
-----------------------	---------------------

Sub-menu (USB Charge Settings)

Always on Charging	<u>Disabled</u> Enabled
--------------------	----------------------------

Quick Charging	Disabled <u>Enabled</u>
----------------	----------------------------

▶ Backlit Keyboard Settings	Enter the sub-menu.
-----------------------------	---------------------

Sub-menu (Backlit Keyboard Settings)

Toggle Color 1	<u>Red</u> Green Blue White Custom
----------------	--

■ Custom

Red Green Blue <ul style="list-style-type: none"> • Can be changed only when [Toggle Color 1] is set to [Custom]. • Specify [Red], [Green], and [Blue] colors with numbers from [0] to [255], or use << F5 >> / << F6 >> keys to set them. 	0 to 255
--	----------

Toggle Color 2	Red Green Blue <u>White</u> Custom
----------------	--

■ Custom

Red Green Blue <ul style="list-style-type: none"> • Can be changed only when [Toggle Color 2] is set to [Custom]. • Specify [Red], [Green], and [Blue] colors with numbers from [0] to [255], or use << F5 >> / << F6 >> keys to set them. 	0 to 255
--	----------

■ Backlight Timeout (seconds)

On Battery Power	<u>None</u> 5 10 15 30 60
Plugged in	<u>None</u> 5 10 15 30 60

▶ Optional Kit Configuration <ul style="list-style-type: none"> • Normally do not change this setting. 	Enter the sub-menu. A separately provided password is required to enter the sub-menu.
---	--

Advanced Menu

Underlined items are the factory presets.

<p>▶ CPU Configuration</p> <ul style="list-style-type: none"> The sub-menu appears when this item is selected. 	Enter the sub-menu.
---	---------------------

Sub-menu (CPU Configuration)

<p>Intel(R) Hyper-Threading Technology</p> <ul style="list-style-type: none"> Can be changed only when [Intel(R) Trusted Execution Technology] is set to [Disabled]. 	<p>Disabled <u>Enabled</u></p>
<p>Intel(R) Virtualization Technology</p> <ul style="list-style-type: none"> Can be changed only when [Intel(R) Trusted Execution Technology] is set to [Disabled]. Can be changed only when [Intel(R) VT-d] is set to [Disabled]. 	<p>Disabled <u>Enabled</u></p>
<p>Intel(R) VT-d</p> <ul style="list-style-type: none"> Can be changed only when [Intel(R) Trusted Execution Technology] is set to [Disabled]. 	<p>Disabled <u>Enabled</u></p>
<p>Intel(R) Trusted Execution Technology</p> <ul style="list-style-type: none"> Can be changed only when [Intel(R) VT-d] is set to [Enabled]. 	<p>Disabled <u>Enabled</u></p>
<p>Intel(R) Turbo Boost Technology 2.0</p>	<p>Disabled <u>Enabled</u></p>
<p>Intel(R) Software Guard Extensions</p>	<p>Disabled Enabled <u>Software Controlled</u></p>
<p>Processor Reserved Memory</p> <ul style="list-style-type: none"> Can be changed only when [Intel(R) Software Guard Extensions] is set to [Enabled]. 	<p><u>Disabled</u> 32MB 64MB 128MB</p>

■ Peripheral Configuration

<p>▶ Serial Port Settings</p> <ul style="list-style-type: none"> The sub-menu appears when this item is selected. Used to configure the serial port. 	Enter the sub-menu.
--	---------------------

Sub-menu (Serial Port Settings)

<p>Serial Port</p> <ul style="list-style-type: none"> Only for model with serial port. 	<p>Disabled Enabled <u>Auto</u></p>
<p>Optical Drive</p> <ul style="list-style-type: none"> Only for model with optical disc drive. 	<p>Disabled <u>Enabled</u></p>
<p>LAN</p>	<p><u>Enabled</u> Disabled</p>
<p>Power On by LAN</p> <ul style="list-style-type: none"> Can be changed only when [LAN] is set to [Enabled]. 	<p><u>Deny</u> Allow</p>
<p>LAN (2nd)</p> <ul style="list-style-type: none"> Only for model with 2nd LAN. 	<p>Disabled <u>Enabled</u></p>

<p>▶ Wireless Configuration</p> <ul style="list-style-type: none"> The sub-menu appears when this item is selected. 	Enter the sub-menu.
--	---------------------

Sub-menu (Wireless Configuration)

Wireless Switch	Disabled <u>Enabled</u>
Wireless LAN <ul style="list-style-type: none"> Only for model with wireless LAN. 	Disabled <u>Enabled</u>
Bluetooth <ul style="list-style-type: none"> Only for model with Bluetooth. Can be changed only when [Wireless LAN] is set to [Enabled]. 	Disabled <u>Enabled</u>
Wireless LAN (2nd) <ul style="list-style-type: none"> Only for model with 2nd wireless LAN. 	Disabled <u>Enabled</u>
Wireless WAN <ul style="list-style-type: none"> Only for model with wireless WAN. 	Disabled <u>Enabled</u>
GPS <ul style="list-style-type: none"> Only for model with dedicated GPS. 	Disabled <u>Enabled</u>

microSD Card Slot	Disabled <u>Enabled</u>
Smart Card <ul style="list-style-type: none"> Only for model with Smart Card slot. 	Disabled <u>Enabled</u>

USB Port and Port Replicator	Disabled <u>Enabled</u>
Legacy USB Support	Disabled <u>Enabled</u>
Camera <ul style="list-style-type: none"> Only for model with camera. 	Disabled <u>Enabled</u>

Boot Menu

Underlined items are the factory presets.

<p>Boot Mode</p> <ul style="list-style-type: none"> If the startup from USB devices is not possible, set [Compatible] and retry. However, setting [Compatible] will require longer time to display the Windows boot screen than setting [Normal]. 	Normal <u>Compatible</u>
--	-----------------------------

<p>▶ UEFI Priorities</p> <ul style="list-style-type: none"> The sub-menu appears when this item is selected. 	Enter the sub-menu.
---	---------------------

UEFI Priorities

Boot Option #1 - #5	Windows Boot Manager Windows Recovery Environment Recovery Partition UEFI: IP4 Intel(R) Ethernet Connection (6) I219-LM UEFI: IP6 Intel(R) Ethernet Connection (6) I219-LM Disabled
---------------------	--

UEFI Boot Device Control

Set whether to enable or disable the startup of each device.

UEFI Boot from Hard Disk	Disabled <u>Enabled</u>
UEFI Boot from Optical Drive <ul style="list-style-type: none"> Only for model with optical disc drive. 	Disabled <u>Enabled</u>
UEFI Boot from LAN	Disabled <u>Enabled</u>
UEFI Boot from USB	Disabled <u>Enabled</u>

To change the boot order

- [Boot Option] for [UEFI Boot Device Control] shows the boot device recognized by Firmware (BIOS).
- Boot from a device or not can be selected at [UEFI Priorities], device by device.
- You can select the boot device during start-up of the computer, too. Press « Esc » key soon after “Panasonic” boot screen is displayed. “Boot Menu” appears and you can select the device. To use this function, set [Boot Popup Menu] to [Enabled].

Security Menu

Underlined items are the factory presets.

Boot Prompt Configuration

Boot Popup Menu	<u>Disabled</u> Enabled
Password On Boot <ul style="list-style-type: none"> The shutdown when the fast startup is enabled, this function is ineffective. 	Disabled <u>Enabled</u>
Password On Reboot	Disabled <u>Same as Boot</u>
Password On Resume <ul style="list-style-type: none"> Can be changed only when [Password On Boot] is set to [Enabled]. This function is effective when the computer is restarted after a shutdown (when fast startup is enabled) and when the computer resumes from hibernation, but not when it resumes from sleep. 	Disabled <u>Enabled</u>
Set Supervisor Password	Enter the password.
Hard Disk Lock <ul style="list-style-type: none"> Can be changed only when [Set Supervisor Password] is set. 	<u>Disabled</u> Enabled
User Password Protection	<u>No Protection</u> Protected

Set User Password <ul style="list-style-type: none"> Can be changed only when [Set Supervisor Password] is set. 	Enter the sub-menu.
--	---------------------

<p>▶ Embedded Security (TPM)</p> <ul style="list-style-type: none"> Only for model that supports TPM. Can be changed only when [Set Supervisor Password] is set. Sub-menu items: <ul style="list-style-type: none"> Sub-Menu Protection TPM State (Depending on the models, this item is not displayed.) Pending TPM operation When [Clear TPM Owner] is selected, clear owner information in the TPM chip. Use for discarding and transferring this product. If you select [Clear TPM Owner] when the BitLocker is effective, you may need to reinstall OS. Current TPM Status Information (Depending on the models, this item is not displayed.) 	Enter the sub-menu.
--	---------------------

<p>▶ Fingerprint Security</p> <ul style="list-style-type: none"> Only for model with Fingerprint Reader. Can be changed only when [Set Supervisor Password] is set. Sub menu items: <ul style="list-style-type: none"> Sub-Menu Protection Power-on Security Clear the fingerprint data 	Enter the sub-menu.
--	---------------------

<p>▶ AMT Configuration</p> <ul style="list-style-type: none"> Only for model that supports Intel(R) AMT. Can be changed only when [Set Supervisor Password] is set. 	Enter the sub-menu.
---	---------------------

<p>▶ Secure Boot</p> <ul style="list-style-type: none"> The sub-menu appears when this item is selected. If you change factory default setting, preinstalled-OS may not operate correctly. 	Enter the sub-menu.
--	---------------------

<p>▶ Absolute Persistence(R) Module</p> <ul style="list-style-type: none"> Absolute(R), formerly Absolute Computrace(R), is a service designed to help track devices and provide recovery services in the event a device is lost or stolen. 	<u>Enabled</u> Disabled Permanently Disabled*2
--	--

*2 : When [Permanently Disabled] is selected, this setting cannot be used again.

Exit Menu

Save Values and Reboot	To reboot the system after saving the changes.
Reboot Without Saving Changes	To reboot the system without saving the changes.

Save Options

Save Current Values	To save the changes for all Setup options.
Load Previous Values	To load previous values for all Setup options.

Load Default Values	To return the settings to the default values.
---------------------	---

■ Boot Override

Windows Boot Manager	Boot from preinstalled OS.
Recovery Partition	Erase your flash memory or restore the computer to its original factory default image.
UEFI: IP4 Intel(R) Ethernet Connection (6) I219-LM	Boot from LAN device (IP4).
UEFI: IP6 Intel(R) Ethernet Connection (6) I219-LM	Boot from LAN device (IP6).
Windows Recovery Environment	Boot from Windows Recovery Environment.

Depending on the hardware constructions, some device name are different.

▶ Diagnostic Utility	Execute Diagnostic Utility.
----------------------	-----------------------------

Operation environment

- Place the computer on a flat stable surface not subject to shock, vibration, and danger of dropping. Do not place the computer upright or turn it over. If the computer is exposed to an extremely strong impact, it may become damaged.

- Operating environment

Temperature:

Operation : -10 °C to 50 °C {14 °F to 122 °F} (IEC60068-2-1, 2)**1

Storage : -20 °C to 60 °C {-4 °F to 140 °F}

Humidity:

Operation : 30% to 80% RH (No condensation)

Storage : 30% to 90% RH (No condensation)

Even within the above temperature/humidity ranges, operation for a long time in extreme environments, smoking nearby, or operation in places where oil is used or where there is a lot of dust will result in the product deterioration and will shorten the product life.

If the computer is wet in temperatures of 0 °C {32 °F} or below, freeze damage may occur. Make sure to dry off the computer in such temperatures.

*1 : Do not expose the skin to this product when using the product in a hot or cold environment. ( OPERATING INSTRUCTIONS - Read Me First "Safety Precautions")

- Do not place the computer in the following areas, otherwise the computer may be damaged.
 - Near electronic equipment. Image distortion or noise may occur.
 - In extremely high or low temperature.
- As the computer can become hot during operation, keep it away from items that are sensitive to heat.

Handling cautions

This computer is designed to minimize shock to parts such as the LCD and the flash memory drive and equipped with a drip-proof keyboard, but no warranty is provided against any trouble caused by shock. Be extremely careful when handling the computer.

- When carrying the computer:
 - Turn off the computer.
 - Remove all external devices, cables and other protruding objects.
 - Remove a disc in the optical disc drive.
 - Do not drop or hit the computer against solid objects.
 - Do not leave the display open.
 - Do not grip the display part.
- Do not put anything (e.g., a piece of paper) between the display and keyboard.
- When you board an airplane, take the computer with you and never put it in your checked luggage.
- When using the computer on airplane, follow the airline's instructions.
- When carrying a spare battery, put it in a plastic bag to protect its terminals.
- Be careful not to get injured by dropping or getting hit when carrying the computer.
- Use only the pen (included) to touch the screen. Do not place any object on its surface and do not press down strongly with sharp-pointed or hard objects that may leave marks (e.g., nails, pencils and ball point pens).
- The touchpad is designed to be used by fingertip. Do not place any object on its surface and do not press down strongly with sharp-pointed or hard objects that may leave marks (e.g., nails, pencils and ball point pens).
- Avoid any harmful substances such as oil from getting into the touchpad. The pointer may not work correctly.
- Touch the screen with the pen (included) or your fingers.

When touching the screen, use only the pen (included) or your fingers on the surface.

Touching the screen with an object other than the pen (included) or your fingertip (a fingernail or metal object, or other hard or sharp objects that may leave a mark) may scar or stain the surface, causing the malfunction.

- Do not apply too much pressure when operating the screen.
Only a light touch is required to operate the screen. Applying too much pressure may damage the surface.
- Do not use the screen when dust or dirt (e.g., oil) is on the screen.
Otherwise foreign particles on the screen/pen (included) can scratch the screen surface or obstruct the pen (included) operation.

Handling the screen

- Do not apply strong pressure to the screen outside of the LCD display.
Applying strong pressure to the screen outside of the display area may result in malfunctions or damage to the LCD screen.
- Do not apply excessive force to the screen.
Do not lift the computer while holding the LCD screen, or allow the screen to be twisted. Do not place any objects on the LCD screen. Any of the above may cause the screen glass to break, or may damage the LCD screen.
- Operation response may be slower in low temperature environments.
The screen may respond to operations more slowly when using the computer in temperatures less than 5 °C {41 °F}, but this is not a malfunction. Response time will return to normal when the computer is returned to room temperature.
- If the pointer jumps to a location other than where the screen was touched, or if the LCD resolution changes, recalibrate the screen.
Perform the procedure of "[Calibrating the Screen](#)".

Handling the pen (included)

- Clean the pen (included) tip and screen prior to operation.
Foreign particles can scratch the screen and impede the operation of the pen (included).
- Use only the pen (included) to touch the screen.
Using it for any other purpose may damage the pen (included) and result in scratches on the screen.
- The pointer cannot follow the pen (included) movement if you move the pen (included) too quickly.
- Do not apply excessive force to the tip of pen.
If excessive force is applied to the pen tip (A), the screen may be damaged, or the pen tip (A) will be easily damaged or deteriorate. Also, leaving the pen tip (A) for a long period of time with pressure applied may cause operational errors or deterioration. Do not apply excessive force to the pen tip (A) since it can be operated with light force.

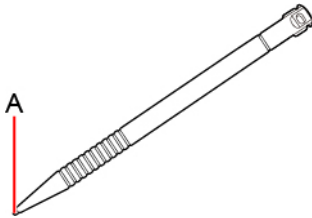

When using peripheral devices

Follow these instructions and this Manual to avoid any damage to the devices. Carefully read the instruction manuals of the peripheral devices.

- Use the peripheral devices conforming to the computer's specifications.
- Connect to the connectors in the correct direction.
- If it is hard to insert, do not try forcibly but check the connector's shape, direction, alignment of pins, etc.
- If screws are included, fasten them securely.
- Remove the cables when you carry the computer. Do not pull the cables forcibly.

Preventing your computer from unauthorized use via wireless LAN/2nd wireless LAN/Bluetooth/wireless WAN

<Only for model with wireless LAN/2nd wireless LAN/Bluetooth/wireless WAN>

- Before using wireless LAN/2nd wireless LAN/Bluetooth/wireless WAN, make the appropriate security settings such as data encryption.

When the battery indicator does not light on

The battery indicator may not light on even if the AC adaptor and the battery pack are correctly connected to the computer, due to the following reasons.



- The AC adaptor's protection function may be working. In this case, pull out the AC cord and wait for more than 1 minute before reconnecting the AC cord.

Sensors

Automatic brightness adjustment

<Only for model with Camera>

The computer is equipped with an automatic brightness adjustment function that adjusts the display screen based on the ambient light sensor. You can configure the automatic adjustment function as follows.

1. Click  (Start) -  (Settings) - [System] - [Display].
2. Add the check mark to [Change brightness automatically when lighting changes] under “Brightness and color”.

IMPORTANT

- The [Change brightness automatically when lighting changes] item may not be available in some cases. In such cases, click the arrow to the left of [Settings] at the top left of the screen, and perform the operation from [System] - [Display] again.

The ambient light sensor is located at the top of LCD.

The ambient light cannot be detected properly if this area is obstructed or dirty.

Maintenance

If drops of water or other stains get on the surface of the LCD panel, wipe them off immediately. Failure to do so may result in staining.

Cleaning the LCD panel

The screen is specially treated to prevent dirt from adhering to the surface. Also, to improve the outdoor visibility of the display, a low reflection coating has been added.

When removing the dirt on the screen surface, use only an approved soft cloth (included) in order to avoid scratches and peeling of the coating.

Before using the computer, be sure to read the instructions provided below.

- Be sure to wipe the LCD display to remove fingerprints, etc., with the soft cloth (included).
- The included soft cloth is designed for cleaning the LCD surface. Do not wipe areas other than the LCD display with it.
- How to use the soft cloth
 - Use the soft cloth when it is dry. Do not apply water or solvents to the soft cloth.
 - First, lightly wipe foreign particles and dust adhering to the LCD display on one side of the soft cloth. Do not use force, since the LCD surface may be damaged with the foreign particles or dust.
Next, wipe off fingerprint, etc., with the other side of the soft cloth.
After wiping off foreign particles and dust, wash the soft cloth (refer to the following) to remove the foreign particles and dust from the soft cloth.
 - When the soft cloth becomes dirty, wash it with neutral detergent. Do not use bleach or a fabric conditioner (softener), or carry out sterilization by boiling.
 - If the LCD gets wet, wipe the surface lightly with the soft cloth.
 - While wiping the LCD display, the computer must be turned off.
- Clean the screen while the computer is powered off.
Cleaning the screen while the power is on may cause the computer to malfunction. Also, dirt on the screen is easier to see when the computer is powered off, and so is easier to clean.
- Wash the soft cloth when it becomes dirty.
When the soft cloth becomes dirty, wash it with mild detergent. Do not use bleach or fabric conditioner (softener), or try to sterilize the cloth by boiling.
If the soft cloth is dirty, it may be ineffective in cleaning the screen, and in fact may cause dirt to adhere to the screen.
- Check the following to prevent the surface of the screen from being scratched.
 - Are you using your fingers or the pen (included) to operate the screen?
 - Is the surface clean?

- Is the soft cloth clean?
- Are your fingers clean?
- Are you using the pen (included) with the tip extended?
- Is the tip of the pen (included) clean?

Cleaning areas other than the LCD panel

Wipe with a soft dry cloth such as gauze. When using detergent, dip a soft cloth in water-diluted detergent and wring it thoroughly.

IMPORTANT

- Do not use benzene, thinner, or rubbing alcohol since it may adversely affect the surface causing discoloration, etc. Do not use commercially available household cleaners and cosmetics, as they may contain components harmful to the surface.
- Do not apply water or detergent directly to the computer, since liquid may enter inside of the computer and cause malfunction or damage.
- Use a soft, dry cloth to wipe droplets of water from the surface of the unit. Do not use a microwave to dry the unit. Doing so will result in malfunction or damage.

To clean inside of the dust cover

Approximately once a month, clean up inside of the dust cover by the following procedure.

1. Turn off the computer and remove the AC adaptor.
2. Turn over the computer, and remove the battery pack. ([▶ Replacing the Battery Pack](#))
<When using second battery pack>
 - Remove the second battery pack. ([▶ Replacing the Battery Pack](#))
3. Remove the screw (A) and dust cover as illustrated below.

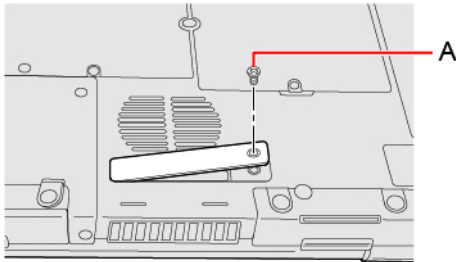

4. Clean up inside of the dust cover.
5. Set the dust cover, screw and battery pack.
Use the PH 1 (PH #1) screwdriver.
The screw used is 1.

Recommended tightening torque

0.45 N•m ± 0.05 N•m (4.5 kgf•cm ± 0.5 kgf•cm)

Optical Disc Drive

<Only for model with optical disc drive>

NOTE

- Connect the AC adaptor if writing operation takes a long time. If the remaining battery power becomes low and the power is not supplied, writing operation may not be completed.
- You need to use writing software to write to discs (e.g. [Using Power2Go](#)).
Ensure the disc is compatible with the selected writing speed.
You can also use Windows features to write to discs ( [Using Windows Feature](#)).
- The quality of written data depends on the disc.

Handling Precautions

Optical disc drive handling care

- Do not expose the optical disc drive to excessive smoke that may leave a residue, e.g., oil smoke, or tobacco smoke. Doing so can shorten the life of the drive lens.
- We recommend cleaning the drive lens with an air puffer used for camera lenses. (Do not use any spray-type of lens cleaning products.)

When opening/closing the tray

- When the computer is on, use the eject button ( [Inserting/Removing a Disc](#)) or eject through Windows.
- When inserting or removing a disc, be careful not to touch the lens and other parts of the laser pickup.
- Do not leave the tray open and do not touch the lens.
The lens and disc can become dusty in some conditions. It may cause malfunction in reading or writing.
- Do not apply excessive force to the tray in the open position.
- Never insert a foreign object such as a paper clip into the optical disc drive.
Doing so may cause malfunction.
- Do not place items other than discs on the tray.
- Do not access the drive until after the tray is closed.
- Set this computer on a horizontal plane.

While the optical disc drive is being accessed

- Do not open the optical disc drive or move the computer while the optical disc drive is being accessed. Doing so could cause the disc to shift position and this may damage the disc, or cause the optical disc drive to malfunction.
- Do not shock the computer by removing or inserting cables and cards, etc. This may result in a read or write malfunction.
- In addition, after running an application involving access to a disc, close the application before opening the optical disc drive.
- Set this computer on a horizontal plane.

Disc handling care

- Do not use deformed, warped, or irregularly shaped discs.
- Reading of disc may not be possible depending on the disc conditions (cracks, dirt, modification, data recording quality, copy protection, recording equipment/software that was used to create the disc, etc.)
- Before using a disc, carefully read the operating/handling instructions and package of the disc.
- If the discs are not handled appropriately, they may become dirty or scratched. Furthermore the writing speed may get slower and the data may not be correctly written on or read from the disc. Other damage may cause a drive failure.
- Note the following precautions.
 - Use an appropriate disc according to the write/rewrite speed. Check descriptions on the disc package and use an appropriate disc according to the write/rewrite speed. Some disc may not accept the specified write speed.

- Do not touch the disc surface (the side with no printing).

<How to hold a disc>

Correct



Incorrect



- Keep the disc surface clean and free from dirt, dust, fingerprints and scratches.
- Do not write on the surface of the disc with a ballpoint pen or other writing instrument.
- Do not attach stickers to discs.
- Do not drop, bend, or place heavy objects on top of discs.
- Do not place or store discs in locations exposed to heat, direct sunlight, humidity or dust.
- If a disc is brought from a cold to a warm location, condensation may form on the disc. For read-only discs, wipe off the condensation using a soft, dry, lint-free cloth before using the disc. For recordable/rewritable discs, wait until the condensation dries.
- When not using discs, keep them in their protective cases or cartridges.

To clean discs

- <For read-only discs>

Wipe discs with a dry, soft cloth from the center toward the edge. If discs get very dirty, wipe with a moist, soft cloth from the center toward the edge, then wipe again with a dry cloth to take up remaining moisture.

Correct



Incorrect



- <For recordable/rewritable discs>

It is recommended to use the Panasonic disc cleaner.

Do not use a cloth.

Disc Information

Data transfer speeds indicate values measured by Panasonic Corporation. The data transfer rate of DVD per 1X speed is 1,350 KB/s. The data transfer rate of CD per 1X speed is 150 KB/s.

Performance of CD-R, CD-RW, High-Speed CD-RW, Ultra-Speed CD-RW, DVD-RAM, DVD-R, DVD-R DL, DVD-RW, +R, +R DL, +RW, High Speed +RW, and M-DISC cannot be guaranteed depending on writing status and recording format. Also, some data cannot be played back depending on the disc, settings, and environment being used.

Reading*1

Format	Continuous Data Transfer speed
CD-ROM	24 X (Max)
CD-R (XA Compatible)	24 X (Max)
CD-RW	24 X (Max)

Format	Continuous Data Transfer speed
High-Speed CD-RW	24 X (Max)
Ultra-Speed CD-RW	24 X (Max)
DVD-ROM (Single Layer, Dual Layer)	8 X (Max)
DVD-R ^{*2} (1.4 GB, 2.8 GB, 3.95 GB, 4.7 GB) ^{*3}	8 X (Max)
DVD-R DL (8.5 GB) ^{*3}	8 X (Max)
DVD-RW (Ver. 1.1/1.2 1.4 GB, 2.8 GB, 4.7 GB, 9.4 GB) ^{*3}	8 X (Max)
DVD-RAM ^{*4} (1.4 GB, 2.8 GB, 4.7 GB, 9.4 GB) ^{*3}	5 X (Max)
+R (4.7 GB) ^{*3}	8 X (Max)
+R DL (8.5 GB) ^{*3}	8 X (Max)
+RW (4.7 GB) ^{*3}	8 X (Max)
High Speed +RW (4.7 GB) ^{*3}	8 X (Max)
M-DISC (4.7 GB) ^{*3}	8 X (Max)
BD-ROM ^{*4}	6 X (Max)
BD-R ^{*4}	6 X (Max)
BD-R DL ^{*4}	6 X (Max)
BD-R XL ^{*4}	6 X (Max)
BD-R LTH ^{*4}	4 X (Max)
BD-RE ^{*4}	6 X (Max)
BD-RE DL ^{*4}	6 X (Max)
BD-RE XL ^{*4}	4 X (Max)

Writing^{*5}

Format	Continuous Data Transfer speed	Recommended discs for writing	Discs you can use for writing
CD-RW	4 X	MITSUBISHI CHEMICAL MEDIA CO.,LTD.	
High-Speed CD-RW	10 X		
Ultra-Speed CD-RW	16 X (Max)	None	
DVD-R ^{*2}	8 X (Max)	Panasonic Corporation/ MITSUBISHI CHEMICAL MEDIA CO.,LTD.	DVD-R for General: 1-8X-SPEED (4.7 GB) 1-16X-SPEED (4.7 GB)
DVD-R DL	6 X (Max)	MITSUBISHI CHEMICAL MEDIA CO.,LTD.	DVD-R DL 2-8X-SPEED (8.5 GB)
DVD-RW ^{*6}	6 X (Max)		1-2X-SPEED (4.7 GB/9.4 GB) 2-4X-SPEED (4.7 GB/9.4 GB) 2-6X-SPEED (4.7 GB/9.4 GB)
DVD-RAM ^{*7}	5 X (Max)	Panasonic Corporation	2-3X-SPEED (4.7 GB/9.4 GB) 2-5X-SPEED (4.7 GB/9.4 GB)

Format	Continuous Data Transfer speed	Recommended discs for writing	Discs you can use for writing
+R	8 X (Max)	MITSUBISHI CHEMICAL MEDIA CO.,LTD.	1-8X-SPEED (4.7 GB) 1-16X-SPEED (4.7 GB)
+R DL	6 X (Max)		2.4-8X-SPEED (8.5 GB)
+RW	4 X (Max)		1-4X-SPEED (4.7 GB)
High Speed +RW	8 X (Max)		3.3-8X-SPEED (4.7 GB)
M-DISC	4 X (Max)	Millenniata, Inc.	
BD-R	6 X (Max)	Panasonic Corporation/ MITSUBISHI CHEMICAL MEDIA CO.,LTD.	1-2X-SPEED (25 GB) 1-4X-SPEED (25 GB) 1-6X-SPEED (25 GB)
BD-R DL	6 X (Max)		1-2X-SPEED (50 GB) 1-4X-SPEED (50 GB) 1-6X-SPEED (50 GB)
BD-R XL	4 X (Max)	Panasonic Corporation/ TDK Corporation / MITSUBISHI CHEMICAL MEDIA CO.,LTD.	2-4X-SPEED (100 GB)
BD-R LTH	4 X (Max)	None	1-2X-SPEED (25 GB) 1-4X-SPEED (25 GB) 1-6X-SPEED (25 GB)
BD-RE	2 X (Max)	Panasonic Corporation/ MITSUBISHI CHEMICAL MEDIA CO.,LTD.	1-2X-SPEED (25 GB)
BD-RE DL	2 X (Max)		1-2X-SPEED (50 GB)
BD-RE XL	2 X (Max)	Panasonic Corporation/ Sony Corporation	1-2X-SPEED (100 GB)

*1 : If an unbalanced disc (e.g., a disc with which the balance has been displaced from the center) is inserted, the speed may become slower if there are large vibrations while the disc is rotating.

*2 : Does not support writing to DVD-R (for Authoring). DVD-R (for Authoring) playback is compatible with discs recorded using Disc-at-Once recording.

*3 : 1 MB = 1,000,000 bytes / 1 GB = 1,000,000,000 bytes. Your operating system or some application software will report as fewer GB.

*4 : Only for model with Blu-ray disc drive.

*5 : Depending on the disc, the writing speed may become slower.

*6 : Does not support DVD-RW Ver. 1.0.

*7 : DVD-RAM: Only non-cartridge type or removable cartridge type can be used. Does not support writing to DVD-RAM 2.6 GB.

Using DVD/BD media

To play DVD-Video/BDMV (only for model with Blu-ray disc drive), you need to use DVD/BD playback software such as PowerDVD.

Inserting/Removing a Disc

1. Turn on the computer.
2. Press the eject button (A) and slowly pull out the tray.

When inserting or removing a disc, be careful not to touch the lens and other parts of the laser pickup (B). Do not touch the disc surface (the side with no printing).

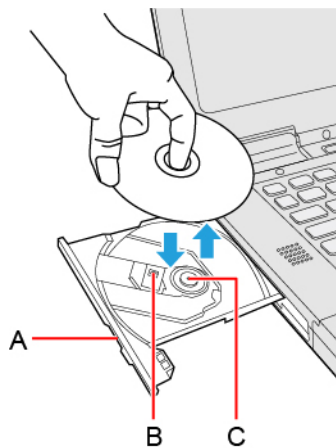

3. Insert/Remove a disc.

- To insert
Set the disc with the label side up and press the center of the disc until it clicks in place.
- To remove
Press on the center spindle (C) and carefully lift up the edge of the disc.

4. Close the tray.

Do not press the eject button (A).

NOTE

- To remove a disc when the computer is powered off, insert a pin of 1.3 {±0.05} mm in diameters into the emergency hole (D). (When the diameter of the pin is smaller than this, insert the pin slightly downward.) Pushing it to the end allows the tray to come out.

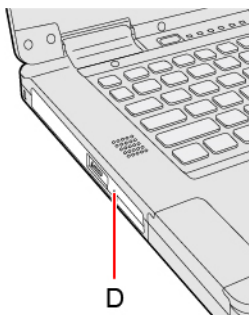

- For AutoPlay CD/DVD/BD:
 - If an AutoPlay CD/DVD/BD does not start after the computer resumes from sleep or hibernation, remove the disc from the drive and then reinsert it after waiting 15 seconds.
 - An AutoPlay CD/DVD/BD may start during file access depending on the status of the disc.
- When playing back motion video from a disc, playback may not be smooth in some conditions.

Power-saving mode

If the optical disc drive is not accessed for 30 seconds, the drive motor will automatically be shut down to reduce the power consumption. When the optical disc drive is accessed again, the drive motor is turned on. In this case, reading of the disc data will take approximately 30 seconds.

Movie Disc Playback

Installing PowerDVD

PowerDVD is a software application for DVD/BD playback. Install "PowerDVD" using "DVD Drive Utility Disc" or "BD Drive Utility Disc".

1. Sign in to Windows as an administrator.
2. Set "DVD Drive Utility Disc" or "BD Drive Utility Disc" in the drive.
3. At the [AutoPlay] message, click [Run SETUPUTIL.EXE].

“Utility Setup tool” screen will appear (allow some time for disc recognition).

When the setup program will not run automatically, perform following step.

1. Display [Run] and input [x:\setuputil.exe]^{*8}, and then click [OK].

1. Right-click  (Start) - [Run].

2. When the “User Account Control” screen is displayed, click [Yes].

^{*8} : “x” is the drive letter. You can change the letter to suit your preference.

4. Click [Power DVD Setup].
5. Select your language and location at welcome screen, then click [Next].
6. During the installation, you will be required to agree the License Agreement. After reading the agreement, click [Accept].
Follow the on-screen instructions.
7. Click  on “Utility Setup tool” screen, and remove “DVD Drive Utility Disc” or “BD Drive Utility Disc”.

Running PowerDVD

You can run “PowerDVD” either of the following procedures.

- Click  (Start) - [CyberLink PowerDVD xx]^{*9} - [CyberLink PowerDVD xx]^{*9} .

NOTE

- Depending on your operating environment or the DVD-Video/BDMV, a minor loss in frames (video and audio skipping) may occur immediately after resuming playback from the pause state.
- Depending on your operating environment or the DVD-Video/BDMV, playback may not be smooth or audio may be difficult to hear during fast forward (time stretch) playback.

- To access the online manual

After starting PowerDVD, click  (Launch the CyberLink PowerDVD help).

If the AutoPlay screen appears when you insert the disc in the optical disc drive

Click  [Play DVD Video - PowerDVD xx]^{*9} .

^{*9} : xx indicates the version number.

PowerDVD operations

Displaying the User’s Guide (PDF)

There are PDF files of some languages in “Languages” folder at PowerDVD folder.

As the version of PowerDVD included with this computer is an OEM version, some functions are restricted and the following features that are described in the Help are not available on this computer.

- Playback and image display for CDs (audio and video) and music files
- Additional features such as Movie Collection and Movie Remix

DVD discs created using a DVD recorder

The following restrictions apply:

- When playing videos recorded on rewritable discs, approx. 40 to 50 seconds may be required to recognize the disc. Wait for the required time.
- Depending on the condition (record quality, cracks, dirt, modification, copy protection, type of drive/disc maker used when creating the disc, etc.) of a disc, it may not be possible to be read or play it correctly.
- In order to play discs other than DVD-RAM, they must be finalized (a process that enables it to play on other DVD players, etc.). For information on the finalizing method used by your DVD recorder, refer to its operating instructions.
- This computer does not include an application or DVD drive for playing AVCREC format or AVCHD format or CPRM format media. As a result, this computer cannot play back DVD media recorded in AVCREC format or AVCHD format or CPRM format.

Region codes

DVD-Video/BDMV is allocated to region codes according to where they are sold. To play the DVD-Video/BDMV, the player's software and the drive must have the corresponding region code.

The region code setting can be changed up to 5 times, including the first time (changing from region [2] to region [2], for example, is not counted).

After the fifth time, the region code setting will be locked and cannot be changed again, even if you reinstall Windows. Be very careful when configuring this setting, as you (the user) are fully responsible for any problems arising from unintended settings.

Region code settings

IMPORTANT

- **DVD-Video sold in certain regions include region code restrictions that require the region code settings of the DVD disc and drive to match in order to play back video. However, some discs include multiple region code settings or are region free.**

The region code of this computer's drive is not set under factory default conditions. As a result, the region code settings screen will appear the first time you attempt to play back a DVD-Video/BDMV (only for model with Blu-ray disc drive).

The region code must be set at this time, even when playing multi-region or region-free discs.

After setting the region code for the first time, the region code settings screen will appear each time a disc of a different region is inserted in the drive.

Checking the region code

You can check the current region setting and the remaining number of times the setting can be changed by following the procedure below.

• For DVD-Video



1. Right-click  (Start) - [Device Manager].
2. Double-click [DVD/CD-ROM drives].
3. Double-click the device name of the optical disc drive (ex: HL-DT-ST DVDRAM GUD0N).
4. Click [DVD Region].

The current region and the number of changes remaining are displayed.

• For BDMV

1. After PowerDVD starts, click  (Configure PowerDVD settings) - [Player Settings] - [Blu-ray Disc].

Cautions on use

- You cannot play back CDs (audio, video, etc.) or DVD-Audio with PowerDVD.
- If your HDMI-compatible display does not support HDCP (High-bandwidth Digital Content Protection), commercially available DVD-Video/BDMV cannot be played back.
- Do not start PowerDVD immediately after starting up the computer or while the drive indicator  or the microSD Memory Card indicator  is blinking.
- When PowerDVD is running, do not:
 - Enter sleep or hibernation.
 - Change the screen display mode. If you inadvertently perform these operations, exit PowerDVD and restart it.
- Do not install other media players while PowerDVD is installed.

If you install another media player, playback errors may occur. Some commercially available DVD-Video files may attempt to install their own media players at playback. Be sure to cancel installation in the installation start screen in such cases. If you accidentally install the player and playback errors occur, uninstall the media player.

Writing to CD/DVD/BD

Applicable media

- Refer to the [Disc Information](#).
- Refer to the software's online manual (below).

About Copies

When writing to discs, make sure that you are not infringing upon any copyrights. It is illegal to copy commercially available audio CDs for non-personal use.

When backing up software, make sure that you are not infringing upon any software copyrights for that product.

Using Windows feature

1. **Insert a disc you can use for writing.**
2. **In the [AutoPlay] screen, click [Burn files to disc].**
 - Alternatively:
 1. Right-click  (Start) - [File Explorer].
 2. Click [This PC].
 3. Double-click [DVD RW Drive] or [BD-RE Drive].
 - Follow the on-screen instructions.

Installing Power2Go

Power2Go allows you to copy CDs/DVDs, and create music CDs, data CDs/DVDs, and DVD-Videos.

You can also write data to Blu-ray discs.

To install the software application, follow the procedure below.

IMPORTANT

- **1 GB of free space on the flash memory is needed to install all the components of Power2Go.**
- **Close all other software application before running the Setup program for Power2Go.**
- **Sign in to Windows as an administrator.**

1. Sign in to Windows as an administrator.
2. Set "DVD Drive Utility Disc" or "BD Drive Utility Disc" in the drive.
3. At the [AutoPlay] message, click [Run SETUPUTIL.EXE].
"Utility Setup tool" screen will appear (allow some time for disc recognition).
When the setup program will not run automatically, perform following step.
 1. Display [Run] and input [x:\setuputil.exe]*10, and then click [OK].
 1. Right-click  (Start) - [Run].
 2. When the "User Account Control" screen is displayed, click [Yes].

*10: "x" is the drive letter. You can change the letter to suit your preference.
4. Click [Power2Go Setup].
5. Select your language at "Choose Setup Language", and then click [OK].
6. During the installation, you will be required to agree the License Agreement. After reading the agreement, click [Yes], then click [Next].
Follow the on-screen instructions.
7. Click [Finish].

Using Power2Go

For further information, refer to the software's online manual (below).

1. Click  (Start) - [CyberLink Power2Go x.x for Panasonic] - [CyberLink Power2Go x.x for Panasonic] .

*11 : x.x indicates the version number.

IMPORTANT

- **If you format a disc using Windows functions, you cannot write with Power2Go.**
Do not format a disc using Windows functions when you write to the disc using Power2Go. For rewritable discs (i.e. CD-RW, etc.), writing is possible using Power2Go if all the disc contents are deleted.
- **If you set an unused disc in the optical disc drive, [AutoPlay] screen may appear and then Windows format screen may be displayed. Do not format the disc when you use Power2Go.**
When you write to the disc using Power2Go, start Power2Go before setting the disc. Windows format screen will not be displayed, which prevents the disc from being mistakenly formatted.

- **To access the online manual**

After starting Power2Go, click  (Help).

Using DVD-RAM

Formatting must be executed to write a file to a DVD-RAM. It is possible to write a file to a formatted DVD-RAM in the same way as writing a file to a flash memory.

Format type

There are following types of DVD-RAM formats, as shown below. We recommend that you choose the format type depending on the application.

Format	Feature
FAT32	This format is supported by Windows 95 (OSR2) / 98 / Me / 2000 / XP / Vista / 7 / 8.1 / 10. DVD-RAM discs in FAT32 format cannot be used on Windows 95 (other than OSR2) / Windows NT.
UDF1.02	This format is supported by Windows 98 / Me / 2000 / XP / Vista / 7 / 8.1 / 10, and compatible with the Video mode of DVD-ROM / DVD-R / DVD-RW / +R / +RW.
UDF1.50	Standard format for DVD-RAM. Data with large file sizes (video or audio data) can be written at high speed. We recommend this format when using DVD-RAM for storing data.
UDF2.00/2.01	This format is used for DVD video recorders conforming to "Video Recording Standards" as established by the DVD Forum, or for PC recording software conforming to the same standards.
UDF2.5	This format is supported by Windows 7 / 8.1 / 10, and is used for Blu-ray recorders or PC recording software conforming to "Video Recording Standards" as established by the Blu-ray Disc Association. This format cannot be used for DVD recorders conforming to "Video Recording Standards" as established by the DVD Forum, or for PC recording software conforming to the same standards.

There are following types of BD-R/BD-RE formats, as shown below.

Format	Feature	Support	
		BD-R	BD-RE
UDF2.5	Standard format for BD-RE discs as established by the Blu-ray Disc Association is supported by the Windows Vista / 7 / 8.1 / 10. This format is used for Blu-ray recorders or PC recording software conforming to "Video Recording Standards" as established by the Blu-ray Disc Association. DVD-RAM discs in UDF2.5 format cannot be used for DVD recorders conforming to "Video Recording Standards" as established by the DVD Forum, or for PC recording software conforming to the same standards.	X	O

Format	Feature	Support	
		BD-R	BD-RE
UDF2.6	Standard format for BD-R discs as established by the Blu-ray Disc Association is supported by the Windows 10. This format is used for Blu-ray recorders or PC recording software conforming to "Video Recording Standards" as established by the Blu-ray Disc Association.	O	X

Formatting method

When formatting is executed, data recorded on the disc is erased. Back up data as required.

1. **Set the disc in the optical disc drive.**
2. **Close all applications that use the disc.**
3. **Right-click  (Start) - [File Explorer].**
4. **Click [This PC].**
5. **Right-click the optical disc drive, and click [Format...].**
6. **Select the settings and click [Start].**
 - When the disc was recorded with Power2Go and you want to record using Explorer, remove the check mark from [Quick Format].
 - It may take long time if you removed the check mark from [Quick Format].
 - Do not cancel formatting partway. Otherwise the disc may no longer accept writing.

IMPORTANT

- **If you have written using Power2Go, you cannot write using other software since the format becomes different. To make this possible, remove the check mark for [Quick Format] on the format display and format the disc.**

microSD Memory Card

The microSD memory card slot on this computer accepts microSD/microSDHC/microSDXC memory cards.

Inserting/Removing the microSD Memory Card

IMPORTANT

- Do not remove or insert the microSD Memory Card until Windows has completed loading.
- Do not remove the card or turn off the computer in the following cases, otherwise the data may be corrupted.
 - While the computer is in sleep or hibernation.
 - While the microSD Memory Card indicator  is on.
 - While data is being read from or written to the card.
 - Immediately after the writing operation, this computer may still continue the access to the card. If you remove the card before the operation is completed, the data may be damaged or the card access may no longer be performed normally.
- Note that Panasonic assumes absolutely no liability for any loss of data recorded by the user, or any other damages, direct or indirect.
- Keep microSD Memory Cards Away from Infants and Small Children.

To insert the card

1. Open the cover (A).
2. Insert the microSD memory card to the microSD memory card slot (B).

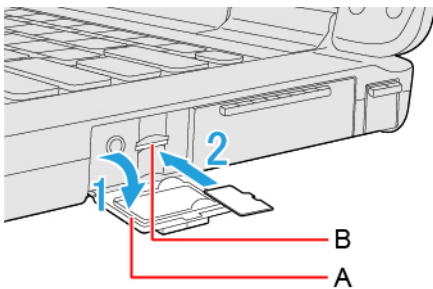



3. Close the cover (A).

To remove the card

Preparation

- Save the data and close all applications.
- Open the cover and confirm the microSD Memory Card indicator  is off.

1. Disable the card function.

1. Click  on the task tray and click .
2. Select the card.

- These steps are not necessary when:
 - Removing the card after turning off the computer.
 -  is not displayed.
 - The card does not appear in the list.

2. Open the cover (A).

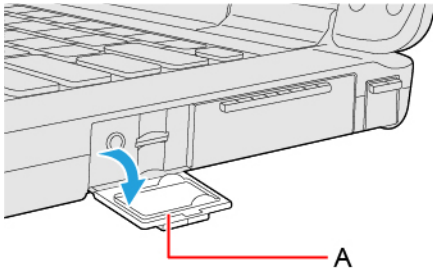

3. Remove the card.

1. Press the card so it comes out of the slot.
2. Draw it straight out.

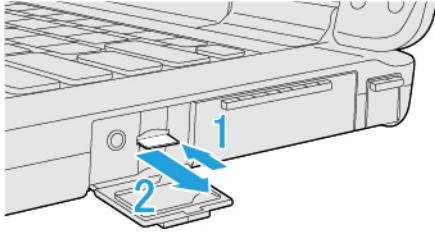

4. Close the cover (A).

IMPORTANT

- After pressing the microSD memory card, do not release your finger suddenly. The microSD memory card may jump out.

Smart Card

<Only for model with Smart Card slot/2nd Smart Card slot>

You need software to use a Smart Card.

IMPORTANT

■ Do not:

- Hit, bend, or drop the card.
- Touch the contact part with fingers or metal object.
- Place the card in very hot location for a long time.
- Remove the card immediately after inserting it.

Inserting/Removing the Smart Card

To insert the card

1. Insert the Smart Card with the contact part (A) in reverse side.

- Insert the card until it surely fits in the slot.

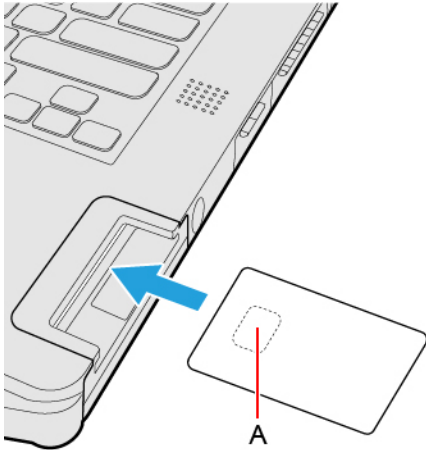

<Only for model with 2nd Smart Card slot>

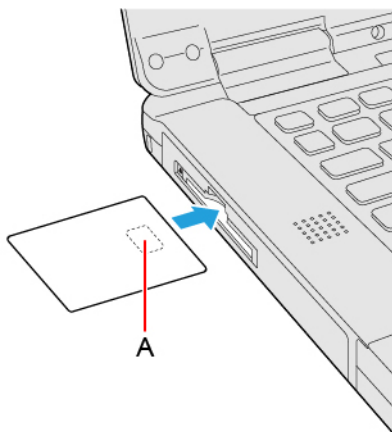

To remove the card

1. Draw the card straight out using your fingers.

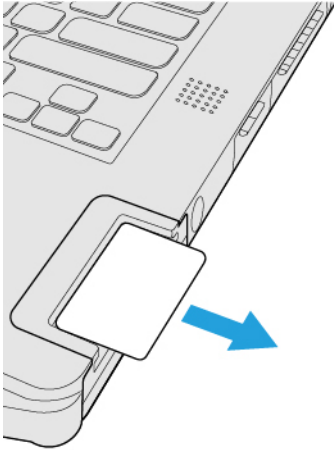

<Only for model with 2nd Smart Card slot>

1. Press the eject button (B).

The Smart Card pops out.

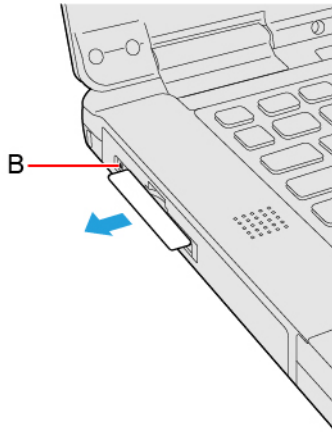

RAM Module

Use RAM modules that comply with the specifications ([➔ Specifications](#)). Using any other module may cause malfunction or result in computer failure.

(For information on the RAM module compatibility, contact Panasonic Technical Support.)

IMPORTANT



- Use recommended RAM module products. Do not use non-recommended RAM modules. Non-recommended RAM modules may not operate properly, and may cause damage to your computer.
- RAM modules are extremely sensitive to static electricity and can be affected even by static electricity from the human body. When inserting and removing RAM modules, do not touch the terminals or internal components, and do not allow foreign particles to enter the slots. Doing so may cause damage, fire, or electric shock.

Inserting the RAM Module

1. Turn off the computer.

- Do not use sleep or hibernation.

Perform the following steps to turn off the computer.

1. Click  (Start) -  (Settings) - [Update & Security] - [Recovery].
2. Click [Restart now] under "Advanced startup".
3. Click [Turn off your PC].

2. Disconnect the AC adaptor, remove the battery pack. ([➔ Replacing the Battery Pack](#))

<When using second battery pack>

- Remove the second battery pack. ([➔ Replacing the Battery Pack](#))

3. Remove the screw (A) and the cover (B) on the bottom of the computer.

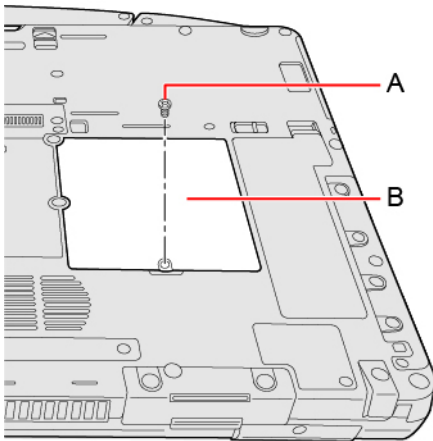

NOTE

- Some illustrations are simplified to help your understanding and may look different from the actual unit.

4. Insert the RAM module.

IMPORTANT

- The RAM module cannot be replaced.

1. Align the cutout (C) with the projection, and tilt the RAM module slightly and insert it in the slot.
2. Press down the RAM module so that the right and left hooks (D) are locked.

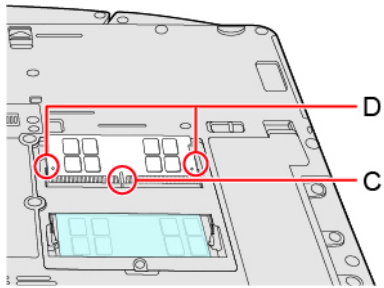

NOTE

- Confirm that the RAM module is fixed with the hooks (E) as shown below.

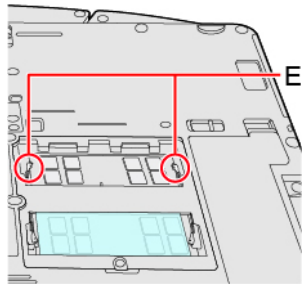

- Remove the release paper (F) of the sheet supplied with the recommended RAM module.



- Firmly attach the RAM module and the seal (G).

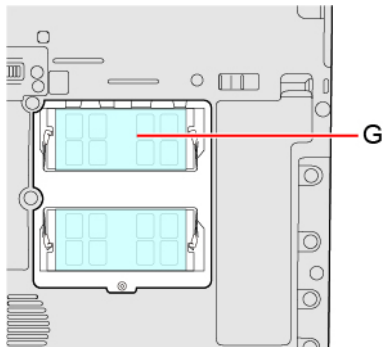

- Set the cover, screw and battery pack.

Use the PH 1 (PH #1) screwdriver.

The screw used is 1.

Recommended tightening torque

0.45 N•m ± 0.05 N•m (4.5 kgf•cm ± 0.5 kgf•cm)

IMPORTANT

- Set the cover and battery pack correctly so that they do not fall when you carry the computer.

NOTE

-
- If it is hard to insert or to press down the RAM module, do not try forcibly but check the module's direction.
 - Use the appropriate screwdriver so as not to strip the thread of screw.
 - If the RAM module is recognized correctly, the total size of the main unit memory and RAM module memory is displayed on the [\[Information Menu\]](#) of the Setup Utility.
If the RAM module is not recognized, power off the computer and insert it again.
-

External Display

HDMI Port

You can switch the output destination to an external HDMI display.

1. Open the cover (A) and connect the HDMI display to the HDMI port (B).

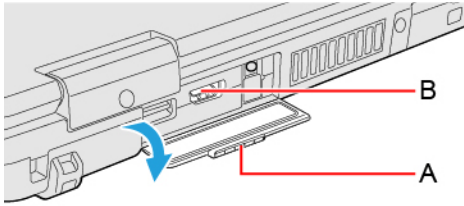

VGA Port

<Only for model with VGA port>

You can switch the output destination to an external analog display.

1. Open the cover (C) and connect the external display to the VGA port (D).

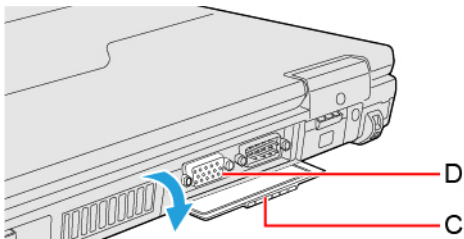

NOTE

- If you connect VGA display after connecting high resolution HDMI display, such as 4K display, images could not be displayed. In such cases, connect VGA display first, and then connect high resolution HDMI display.

USB 3.1 (Type-C) Port

You can switch the output destination to an external display.

The USB 3.1 (Type-C) port of this computer complies with the following standards.

- **DisplayPort Alternate Mode**

A standard to transfer digital video signals to an LCD, etc. Using USB Alternate Mode, images can be displayed on the external display from the USB 3.1 (Type-C) port.

- **USB Power Delivery <only for model that supports power delivery>** ( [USB Power Delivery](#))

1. Open the cover (E) and connect the external display to the USB 3.1 (Type-C) port (F).

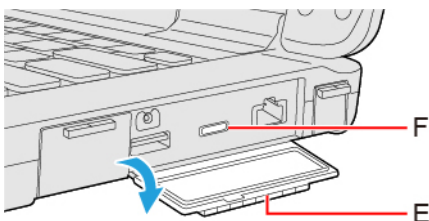

NOTE

- When using a DisplayPort-compatible display, connect with a USB Type-C cable.
- For connection with an external display, read the operating instructions supplied with the display as well.

Switching the display mode

Using key function



1. Press  key + $\llcorner P \gg$ or $\llcorner Fn \gg + \llcorner F3 \gg$.
2. Select the display mode.

Using the [Display settings]

1. Click  (Start) -  (Settings) - [System] - [Display].
2. Select the item under "Multiple displays".

NOTE

- After switching the display mode, the display resolution may change.
- After resuming from sleep or hibernation, or restarting the computer, the output destination may not be the same as selected in the previous status.
- When you change the display after Windows starts up, do not press any key until switching is complete.
- Until Windows startup is completed (during Setup Utility, etc.), the simultaneous display cannot be used and pressing $\llcorner Fn \gg + \llcorner F3 \gg$ switches the display between the internal LCD and the external display.
- Do not connect or remove the external display during sleep or hibernation.
- It may take some time to switch between displays depending on the displays used.
- When you use the external display only, set the suitable number of colors, resolution, or refresh rate separately from when you use the internal LCD only or when you use the simultaneous display.
Depending on the settings, some external displays may be distorted or may not display the mouse pointer correctly. In this case, set the settings to lower value.
- When you use the simultaneous display, DVD-VIDEO, MPEG files and other motion image files may not be played back smoothly.
- Carefully read the instruction manual of the external display.
- When connecting an external display that does not conform to the Plug & Play standards, select the display driver accordingly in the following menu, or use the driver disc supplied with the monitor.

1. Click  (Start) -  (Settings) - [System] - [Display].
2. Click [Advanced display settings] under "Multiple displays".
3. Click [Display adapter properties for Display *].
* is a display number.
4. Click [Monitor] - [Properties].
5. Click [Driver] - [Update Driver].

IMPORTANT

- Before disconnecting the external display, switch to the internal LCD by pressing $\llcorner \img alt="Windows logo" data-bbox="634 732 664 756"/> \gg$ key + $\llcorner P \gg$ or $\llcorner Fn \gg + \llcorner F3 \gg$. Otherwise the displayed image quality may become different after disconnection (e.g., wrong resolution). In this case, press $\llcorner \img alt="Windows logo" data-bbox="864 760 894 784"/> \gg$ key + $\llcorner P \gg$ or $\llcorner Fn \gg + \llcorner F3 \gg$ to reset the image quality.
- The screen may become distorted due to the following operations. In this case, restart the computer.
 - Disconnecting an external display for which you have set high resolution or high refresh rate.
 - Connecting/disconnecting an external display during computer operations.

Extended Desktop

NOTE

-
- It may not be possible to use the extended desktop with some software applications.
 - When you click the maximize button, the window is displayed on one of the displays. You cannot move the maximized window to the other display.
 - The pop-up displayed by «Fn» key combination appears only on the primary display.
 - While using an extended desktop or [Second screen only], you cannot operate the external display screen with touch operation.
 - Set the internal LCD to the primary display when using the touchscreen (only for model with touchscreen). The cursor will move on the primary display when you touch the internal LCD.
-

Features of the Supported Standards

USB 3.1 (Type-A) port

Support USB 1.1, 2.0, 3.0 and 3.1 Gen 1.

USB 3.1 (Type-C) port

The features of the supported standards are as follows.

- USB 3.1 (Gen 1)
- USB Power Delivery <only for model that supports power delivery> ( USB Power Delivery)

Connecting/Removing USB Devices

To connect the USB device

Right side

1. Open the cover (A) and connect the USB device to the USB 3.1 (Type-A) port (B) or the USB 3.1 (Type-C) port (C) on the computer.

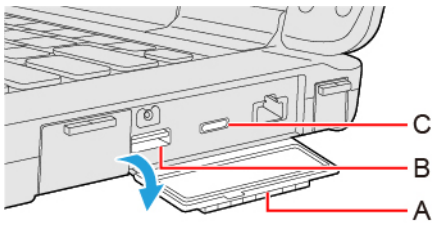

Rear side

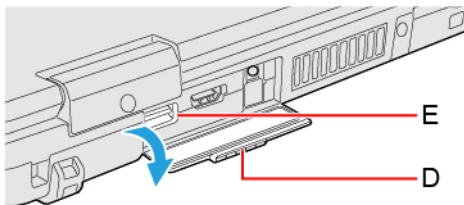

1. Open the cover (D) and connect the USB device to the USB 3.1 (Type-A) port (E) on the computer.



To check whether the connected device supports USB 3.1 Type-C, refer to the operating instructions supplied with the device.

To remove the USB device

1. Disable the USB device.

1. Click  on the task tray and click .

2. Select the USB device.

• These steps are not necessary when;

- Removing the device after turning off the computer.

-  is not displayed.

- The device does not appear in the list in step 2.

2. Remove the USB device.

NOTE

- You may need to install the driver for the USB device. Follow the on-screen instructions or refer to the instruction manual of the USB device.
- You may need to install the driver again when connecting the device to another port.
- When a USB device is connected, sleep or hibernation may not function normally. If the computer does not start up normally, remove the USB device and restart the computer.
- When the USB device is removed and then inserted while the computer is on,  may appear in the Device Manager and the device may not be correctly recognized. In this case, remove and connect the device again, or restart the computer.
- When a USB device is connected, power consumption increases. Remove the USB device when it is not in use, especially when operating by battery power.
- If the computer enters sleep while a USB keyboard or mouse is connected, touching the USB keyboard keys or mouse will resume the computer.

Charging USB Devices

The computer comes with a USB port to provide efficient charging to smart phones or portable devices that can use USB port charging.

This computer's USB 3.1 (Type-A) port equipped with the continuous power supply function and USB 3.1 (Type-C) port allow USB devices to be charged efficiently even if the computer is turned off or in the sleep/hibernation state.

The high speed charging is supported at the following situation.

The computer is turned on; When the computer is turned off ; in sleep/hibernation mode

USB Charge Setting

1. Click  (Start) -  (Panasonic PC Settings Utility), and click  (Settings) -  (USB).

Enabling or Disabling Power-Off Charging

1. Add or remove a check mark to [Enable Always on Charging].

NOTE

- Charging of some USB devices may not be possible. Therefore, check the device before charging it.
- Charging time varies depending on the USB device.
- Connect the USB device directly to the USB port. If connection is via a USB hub, charging may not be possible.
- For devices which do not require charging, connect them to other ports.
- If the computer is not connected to the AC adaptor, its battery power will be consumed quickly.
- Do not insert any foreign object in the USB port.
- When the computer resumes from sleep or hibernation, it may not be able to detect the USB device. If this happens, removing and then reconnecting the USB device may enable the computer to detect the device.
- USB charging is not performed if you press the power switch for more than 4 seconds to turn off the power, or if you reconnect the AC adaptor and battery after removing them in power-off state.
- With USB charging during power-off enabled, if a USB keyboard or USB mouse is connected to the port allowing USB quick charging, then they cannot be used to resume the computer from sleep.
For USB devices which do not require charging, connect them to other ports.
- If charging is done when the computer is powered by battery, charging automatically stops when the battery level drops below 10 %.

Enabling or Disabling USB Quick Charging

1. Set [Quick Charging] to [Enabled] in the sub-menu of [USB Charge Settings] in the [Main] menu of the Setup Utility.

NOTE

-
- If USB quick charging is set to be always enabled, the following problems may occur.
 - USB device cannot be detected as a USB device.
 - Charging is not possible.
 - For some USB devices in USB quick charging, even though the computer is connected to the AC adaptor, it may temporarily switch to battery operation. If this happens, disable USB quick charging.
 - Depending on the USB device, its charging may not be possible.
 - Charging time varies depending on the USB device.
 - Connect the USB device directly to the USB port. If connection is via a USB hub, charging may not be possible.
 - For devices which do not require charging, connect them to other ports.
 - If the computer is not connected to the AC adaptor, its battery power will be consumed quickly.
 - Do not insert any foreign object in the USB port.
 - When the computer resumes from sleep or hibernation, it may not be able to detect the USB device. If this happens, removing and then reconnecting the USB device may enable the computer to detect the device.
-

Charging with USB 3.1 (Type-C) port

This computer can send a maximum power of 15 W.

The USB 3.1 (Type-C) port enables charging even if the computer is turned off, regardless of the [Enabling or Disabling Power-Off Charging](#) setting.

IMPORTANT

- **When using a USB Power Delivery, use a cable that supports USB Power Delivery.**
Depending on the cable, power may not be supplied to the connected device properly.

USB Power Delivery <only for model that supports power delivery>

Connect the USB device to the USB 3.1 (Type-C) Port.

USB Power Delivery is a standard that allows up to 100 W of power supply using a USB cable.

- Power supply from USB Power Delivery-compatible devices to this computer:
The power can be supplied from USB Power Delivery-compatible devices with the following power supply capabilities.
Power ON or Modern standby: 85 W or more
Power OFF or Hibernation: 7.5 W or more*¹
*1: If the output on the USB Power Delivery-compatible device side is less than 15 W, the battery cannot be fully charged.
- Power supply from this computer to USB Power Delivery-compatible devices:
Up to 15W
- Use a cable that supports USB Power Delivery.
It is recommended to use a cable that supports 5 A. When using a cable that does not support 5 A, the power supply cannot be supplied from USB Power Delivery-compatible devices during power on or modern standby.

Driving/Charging the computer using USB Power Delivery

The USB 3.1 (Type-C) port of this computer supports the USB Power Delivery.

IMPORTANT

- **Connect a cable that supports USB Power Delivery.**

NOTE

- If the battery level is less than 5%, the PC cannot be started up.
 - The following functions cannot be performed.
-

-
- Updating firmware such as BIOS
 - Battery Recalibration
 - Create a Recovery Disc
- If the battery indicator blinks orange or turns off, the battery is not charged
-

Serial Port

<Only for model with serial port>

Connecting Serial device

1. Open the cover (A).
2. Connect the serial device to the serial port (B).

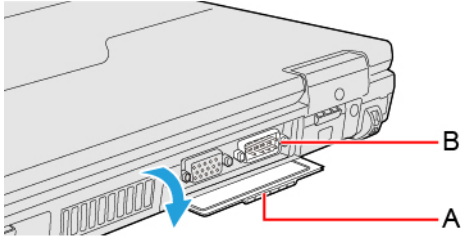

3. Connect the serial device to the connector of the serial cable.

NOTE

- When connecting a cable, be sure to secure it with screws (C).

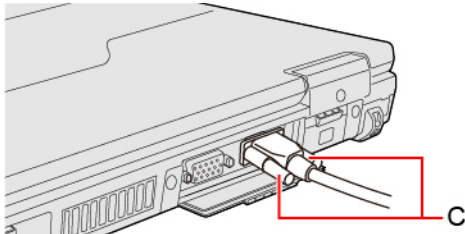

- It does not support serial mouse.
- Plug size thickness: Max. 15.5 mm

Camera

<Only for model with Camera>

Using the Camera

For the camera position and functions, refer to “[Description of Parts](#)”.



NOTE

- When the camera is in use, the Camera Indicator lights up. (Even if [Concealed Mode] is set to [Enabled] and [LED] to [OFF], the camera indicator cannot be turned off.)
- When the computer is moved from hot and humid environment to low temperature environment, dew condensation may form on the lens. This is not a malfunction. Wait until the lens dries out.

About the Ambient Light Sensor

The ambient light sensor is used to adjust the display screen brightness automatically.

To configure the automatic adjustment function, proceed as follows.

1. Click  (Start) -  (Settings) - [System] - [Display].
2. Add the check mark to [Change brightness automatically when lighting changes] under “Brightness and color”.

NOTE

- When using the “Panasonic PC Day Night Mode Utility”, do not use the automatic adjustment function.

Panasonic PC Camera Utility

The Panasonic PC Camera Utility can be used to shoot photos and videos.

When you use pictures and videos recorded using this utility at Web conferences, or other services, use specialized applications accordingly.

NOTE

- If you use this utility and other multi-media software at the same time, an error may occur. Close all multi-media software including this utility and restart this utility.
- If an error message appears and nothing is displayed, restart this utility.
- When the computer has resumed from sleep and hibernation, an error may appear and the connection with the camera device may be lost. If this occurs, restart this utility.
- Panasonic PC Camera Utility only with the built-in camera. It does not support a camera connected to the computer.

Starting up

1. Click  (Start) -  (Panasonic PC Camera Utility).



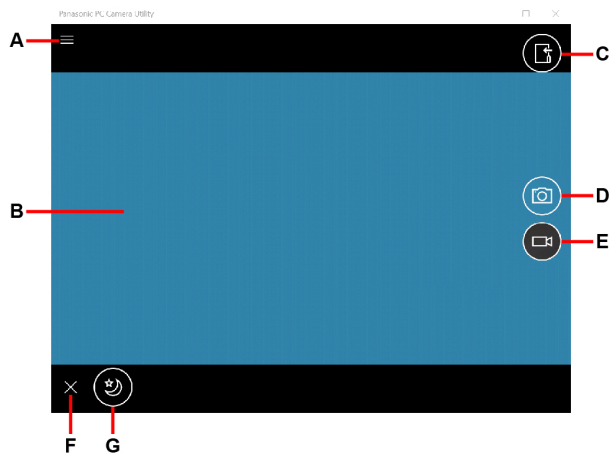

The Panasonic PC Camera Utility starts up, and the following screen is displayed.

- When the utility is running, do not remove or insert audio devices (such as microphones and speakers). Also, do not enable or disable such devices.



- A. Open the camera settings
- B. Preview screen
- C. Display the folder where recorded data is saved
- D. Shoot photos
- E. Start/Stop shooting videos
- F. Hide the mode menu
- G. Night Mode switching

Shooting Photos and Videos

Shoot photos	<ol style="list-style-type: none"> Click  . <ul style="list-style-type: none"> You cannot shoot photos when the save destination storage space is less than 10 MB.
Start/Stop shooting videos	<ol style="list-style-type: none"> Click  . The camera switches to the video shooting mode. Click  . During shooting, the icon is shown as  . To stop shooting, click  . <ul style="list-style-type: none"> If the save destination storage space becomes less than 100 MB during video shooting, shooting will automatically stop.
NOTE	
<ul style="list-style-type: none"> Shooting will stop when you minimize the application window, or put the computer into the hibernation mode during video shooting. 	

Turn the Night Mode ON

To make the dark viewing image brighter

1. Click .

When using the Night Mode, the icon is shown as .

NOTE

- Updating the preview screen may be delayed when using the Night Mode.
- CPU utilization increases when using the Night Mode. If you leave the computer for long hours, the area around the exhaust vent may be heated.

Display the recorded image or video files

1. Click .

The recorded data will be saved in the displayed folder named the recording date.

Changing the Settings

1. Click  - .

The "Setting" menu is displayed.

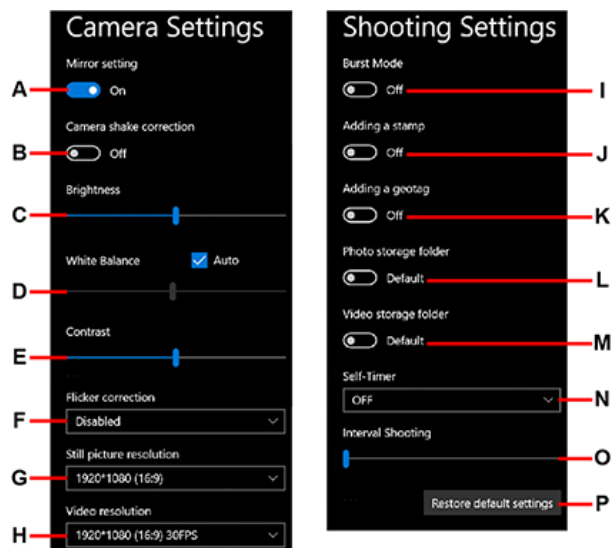

A. Mirror setting

Make the preview screen mirror-reversed (flip horizontal). (Recorded images will not be reversed)

B. Camera shake correction

Enable the image stabilizer when shooting photos.

C. Brightness

Change the brightness of camera images.

D. White Balance

Change the white balance of camera images. To set manually, uncheck the [Auto] option.

E. Contrast

Change the contrast of camera images.

F. Flicker correction

Set the flickering correction of camera images.

G. Still picture resolution

Change the still picture resolution. Perform touch operation or mouse click to select the resolution. The resolution may not be correctly specified if you use the keyboard cursor keys.

H. Video resolution

Change the video resolution. Perform touch operation or mouse click to select the resolution. The resolution may not be correctly specified if you use the keyboard cursor keys.

- Note that the described FPS values are theoretical. They may be decreased depending on the actual use conditions.

I. **Burst Mode**

Press and hold the photo shooting button to shoot continuously while the button is pressed. The maximum number of continuous shooting is 20.

- You cannot shoot continuously when using the Night Mode.

J. **Adding a stamp**

Add geolocation and time stamps to still images.

K. **Adding a geotag**

Add geotagging to the Exif data of still images.

L. **Photo storage folder**

Specify the destination of recorded photo data to save. The default value is the "Pictures" folder.

M. **Video storage folder**

Specify the destination of recorded video data to save. The default value is the "Videos" folder.

- If you specify the FAT32 formatted storage as destination to save, video files cannot be correctly created when the storage data capacity exceeds 4 GB.

N. **Self-Timer**

Specify the time period until shooting starts after the button is pressed. (OFF/5 sec./10 sec.)

O. **Interval Shooting**

When you move the slider to the right, and specify the value except [0], the camera automatically repeats shooting at intervals of specified seconds. The maximum 10 photos can be shot continuously.

P. **Restore default settings**

Return all the settings to the default values.

To close the [Setting] menu, click  on the upper left of the screen, or click the preview screen.

NOTE

- To specify the save destination folder, select the folder you have the access right to. If a writing error occurs, change the specified folder.
- The drive that appears by performing the following procedure will be used as the location in which the "Pictures" and "Videos" folders will be stored.

Click  (Start) -  (Settings) - [System] - [Storage], and then click [Change where new content is saved] under "More storage settings".

Contactless Smart Card Reader/RFID Reader

<Only for model with Contactless Smart Card Reader/RFID Reader>

You can read the data from RFID (Radio Frequency Identification) tags / Contactless Smart Card.

Precautions

NOTE

- This sensor is typically used with specialized applications. For further information, ask the system administrator.
- Contactless Smart Card Reader Location

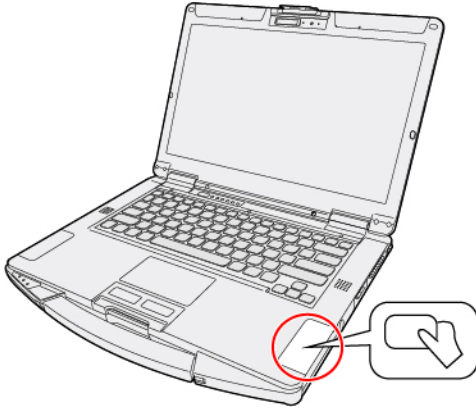

1. Aim the center of RFID tag / Smart Card at the Contactless Smart Card Reader.
 - Continue operation by using the specialized applications.

NOTE

- Wave cards one at a time. If multiple cards are waved simultaneously, proper reading will not be possible.
- If the chip device is held outside of the contactless smart card reader area or at an angle, or waved incorrectly, proper reading may not be possible.
- Operation distance depends on RFID tag / Smart Card.

Fingerprint Reader

<Only for model with Fingerprint Reader>

Precautions

For Security When Using Fingerprint Authentication

- **Fingerprint authentication does not guarantee complete user authentication and identification. Please note that we cannot accept liability for any loss or damage incurred from your use or inability to use fingerprint authentication. Please be forewarned.**
- **We cannot accept liability for any loss of data due to malfunction of the fingerprint reader.**
- **Registration may be impossible if there is insufficient fingerprint or other information to identify an individual.**

Fingerprint Reader Handling

- **Avoid the following. Failure to do so may result in malfunction or damage to the fingerprint reader.**
 - Do not rub or scratch the reader with hard materials or poke it with small pointed objects that could cause scratches.
 - Do not touch the surface with dirty fingers.
 - Do not soil or cover the reader with a sticker.
- **In the following cases, fingerprint reader sensitivity may be degraded, impeding or preventing authentication and registration.**
 - If the surface of the fingerprint reader is soiled with dirt, skin oil, or sweat
 - If the surface of the fingerprint reader is wet by moisture or condensation
 - If your finger is too wet or too dry
 - If your finger is wounded or inflamed
 - If your fingerprint grooves have become too shallow due to wear
 - If you touch the fingerprint reader while sliding your finger
 - If you touch the fingerprint reader with a finger at an angle
 - If the pressing force to touch the fingerprint reader is weak
 - If your finger is swollen, such as from bathing
 - If your fingerprint has changed due to weight loss or gain
- **Fingerprint reader sensitivity may be restored by the following.**
 - Wipe the fingerprint reader with a soft cloth.
 - Wash and wipe your hands.
 - Use another finger for registration and authentication.
 - If your finger is extremely dry, moisten it using hand cream.
- **Static electricity can cause the fingerprint reader to malfunction. To discharge static electricity, touch a metal surface before touching the fingerprint reader. Be especially careful about static electricity in the winter and in other dry conditions.**
- **When a faulty fingerprint reader is repaired, previously saved passwords may be reset in the process. Please be forewarned.**

Setting a Password

If you forget your sign in password you will be unable to use the device or Windows, so be absolutely certain that you will not forget it.

Fingerprint Authentication Function

Use fingerprint authentication to improve security and convenience by replacing the conventional password entry required to sign in to windows.

Fingerprint Authentication Function Features

You can use the fingerprint authentication function by using the Windows Hello.

- **Pre-boot authentication (PBA)**

Perform fingerprint authentication before the computer starts up. Set the Supervisor Password for the Setup Utility beforehand.

- **Sign in fingerprint authentication**

Use fingerprint authentication to unlock your computer and sign in to Windows.

Fingerprint Authentication Initial Configuration

Preparations for Using Fingerprint Authentication

Use the following procedure for fingerprint authentication function with this device.

Set up a Windows user account and password.



Sign in with a user account that uses this device to register fingerprints.



Perform Pre-boot authentication (PBA) as necessary.

Fingerprint Reader Location



Step 1. Set up a user account and password.

If a user account for fingerprint authentication and a Windows sign in password have already been set, skip to Step 2.

If a user account for fingerprint authentication has not yet been set, set up a new user account and password.

NOTE



- **There are two types of user account.**

- Administrator
- Standard user

Some operations and settings are partially prohibited by standard user (restricted user) accounts.

Step 2. Register a Fingerprint (Windows Hello settings)

Step 2-1. Start registering fingerprints

1. Click  (Start) -  (Settings) - [Accounts] - [Sign-in options].
2. Click [Set up] under "Fingerprint" in "Windows Hello".
3. When the "Windows Hello setup" screen is displayed, click [Get started].

Step 2-2. Register Fingerprint Data

1. **Enter fingerprints on the fingerprint reader.**
 - Enter the fingerprint of one finger more than once until the scan is complete. Repeat touching and releasing your finger on the fingerprint reader.
 - The progress of the fingerprint is displayed on the “Windows Hello setup” screen.
 - Follow the on-screen instructions.
2. **To register more fingers, click [Add another finger] and repeat the same procedure.**

Step 2-3. Set up a PIN number

1. **Click [Set up PIN].**
2. **Enter your account password, and click [OK].**
3. **Enter your PIN number in [New PIN].**
4. **Enter your PIN number again in [Confirm PIN], and click [OK].**

NOTE

- **Register at least two fingers.** That way, if by any chance one finger is injured, another can be used.

IMPORTANT

- **To prevent scanning errors, pay attention to the following.**
 - Touch the fingerprint reader with the first joint of the finger you want to register.

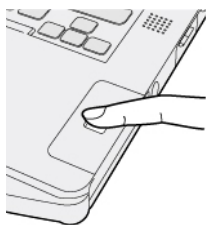

- **In the following cases, the fingerprint reader may fail to register or authenticate.**
 - You touch the fingerprint reader while sliding your finger.
 - You touch the fingerprint reader with a finger at an angle.
 - The pressing force to touch the fingerprint reader is weak.
 - The finger is dirty or scarred.
 - The finger is too wet or too dry.

See “[Fingerprint Reader Handling](#)” for details.

- **In rare cases, features necessary for fingerprint authentication may not be detected.**
In such cases, try registering another finger.

Step 3. Perform Pre-boot authentication (PBA) as necessary.

If you set the Supervisor Password with the fingerprint registered, you can perform pre-boot authentication with a fingerprint instead of the password.

1. **Set the Supervisor Password with Setup Utility (**  **[Setting the Supervisor Password/User Password](#)).**

How to use the fingerprint authentication function

1. **Turn on the computer.**
2. **When the screen to sign in to Windows is displayed, touch the registered finger on the fingerprint reader.**
3. **Windows start up.**

When Pre-boot authentication (PBA) is set

1. **Turn on the computer.**
2. **When fingerprint authentication screen is displayed, touch the registered finger on the fingerprint reader.**



3. When authenticated, the display of the fingerprint switches as shown below and Windows starts up.



IMPORTANT

- If fingerprint authentication failed three times, the computer turns off.
- You can switch to password input by pressing the «Esc» key.

Uninstalling the fingerprint authentication function

Perform the following procedure to delete the device's fingerprint authentication utility.

1. Click  (Start) -  (Settings) - [Accounts] - [Sign-in options].
2. Click [Remove] under "Fingerprint" in "Windows Hello".

IMPORTANT

- To remove the fingerprint authentication function after the Windows reinstallation, perform the procedure below.
 1. Select [Clear the fingerprint data] in [Fingerprint Security] in the [Security] menu of the Setup Utility, and select [Yes].

Do not perform this procedure other than after the Windows reinstallation.

Discreted GPU

<Only for model with Discreted GPU>

Precautions



For the users of the model with Discreted GPU

Your computer is equipped with two graphics processing units (GPUs). The Intel® GPU (Intel® HD Graphics) consumes less power, but reduces the graphics display performance. The discrete GPU consumes more power, but maintains a higher graphics display performance. Normally, only the Intel® GPU is activated, but when you launch an application program requiring high graphics display performance, the discrete GPU activates to assist the Intel® GPU, allowing you to enjoy high quality video on the screen.

In this manual, refer to the sections preceded by the following descriptions, whenever they appear.

Always activating or deactivating the discrete GPU

Since the discrete GPU for high graphics display performance is activated and deactivated automatically, you do not have to worry about which of the two GPUs are currently used. You can also specify whether or not to automatically activate the discrete GPU by program. Perform the procedure below.

1. Click  (Start) -  (Settings) - [System] - [Display].
2. Click [Graphics settings].
3. Select [Universal app] under “Choose an app to set preference”.
4. Select the application you want to set from the drop-down list displayed below.
 - If the application you want to set is not listed, select [Classic app] under “Choose an app to set preference”.
Click [Browse] to select the .exe file you want to add, click [Add].
5. Click [Add].
6. Click the displayed application, and click [Options].
7. Choose whether to run applications on the [High performance], [Power saving] or [System default].
8. Click [Save].

Inserting/Removing the SSD Pack

You can replace the SSD Pack.



IMPORTANT

- Back up all the important data before removing the SSD Pack.
- If you need to read the SSD Pack data on another computer for repair or any other purpose, set [\[Hard Disk Lock\]](#) to [Disabled] in the [Security] menu of the Setup Utility before removing the SSD Pack.
- Carefully remove/insert the SSD Pack since the SSD Pack is extremely sensitive to shock. Note that static electricity may affect some internal components.

1. Turn off the computer.

- Do not use sleep or hibernation.

Perform the following steps to turn off the computer.

1. Click  (Start) -  (Settings) - [Update & Security] - [Recovery].
2. Click [Restart now] under "Advanced startup".
3. Click [Turn off your PC].

2. Disconnect the AC adaptor, remove the battery pack. ([Replacing the Battery Pack](#))

<When using second battery pack>

- Remove the second battery pack. ( [Replacing the Battery Pack](#))

3. Insert/Remove the SSD Pack.

- To remove <SSD pack (FZ-VSDR55)>

1. While sliding the latch (A), lift the SSD Pack (B) and slide it out of the slot.

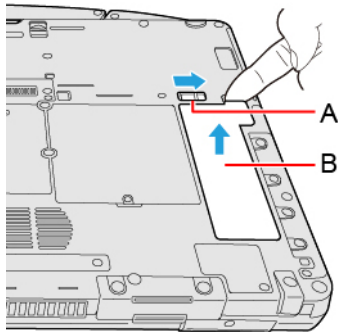

- To remove <SSD Pack (FZ-VSD551)>

1. While sliding the latch (C), pull out the SSD Pack (D).

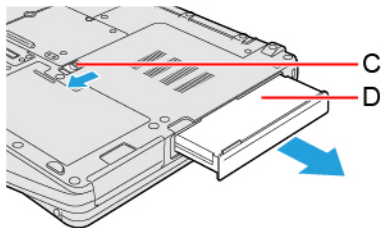

- To insert <SSD pack (FZ-VSDR55)>

1. Insert the projection part (E) of the SSD pack into the (F) part, and attach it while lowering until it clicks.

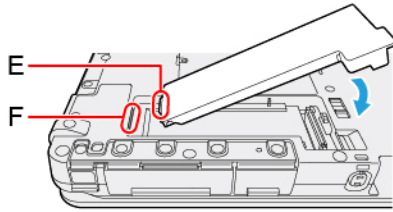

- To insert <SSD Pack (FZ-VSD551)>

1. Slide the SSD Pack in parallel with the arrow direction until it click to the secured position.

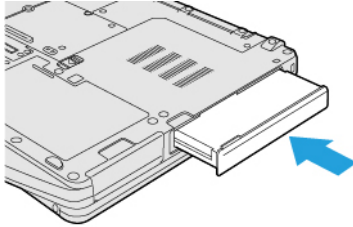

4. Insert the Battery Pack ( [Insert the Battery Pack](#)).

IMPORTANT

- Confirm that the latch is surely locked so that the SSD Pack does not fall when you carry the computer.
- Be sure to attach the SSD Pack for use.

NOTE

- You can erase the data before changing the SSD Pack ( [Erasing Flash Memory Data](#)).
- You can check that the SSD Pack is recognized or not in the [\[Information Menu\]](#) of the Setup Utility. If the SSD Pack is not recognized, turn off the computer and insert it again.



Flash Memory Drive

<Only for model with flash memory drive>

Depending on the model, a flash memory drive is mounted instead of a hard disk drive. (A hard disk drive is not mounted.) In the other chapter of this manual, replace “hard disk” and “hard disk drive” mentioned in this manual with “flash memory” and “flash memory drive”. The procedure for inserting/removing the flash memory drive is same as the one of for the hard disk drive.

( [Inserting/Removing the SSD Pack](#))

NOTE

- [Hard Disk] displayed on [Information] Menu of the Setup Utility refers to the flash memory ( [Information Menu](#)).
- [Hard Disk Lock] displayed on [Security] Menu of the Setup Utility restricts read/write operation for the flash memory data ( [Hard Disk Lock](#)).
- The flash memory is self-diagnosed as “Storage” ( [Hardware that can be checked using the PC-Diagnostic Utility](#)).

Port Replicator (CF-VEB541 series)

<Optional>

You can use an optional port replicator (CF-VEB541 series). This device frees you from being bothered by a lot of cable connections when you carry the computer. It also allows you to connect various peripherals.

Connect the port replicator to the expansion bus connector (A) on the bottom of the computer.

Read the instruction manual of the port replicator before using.

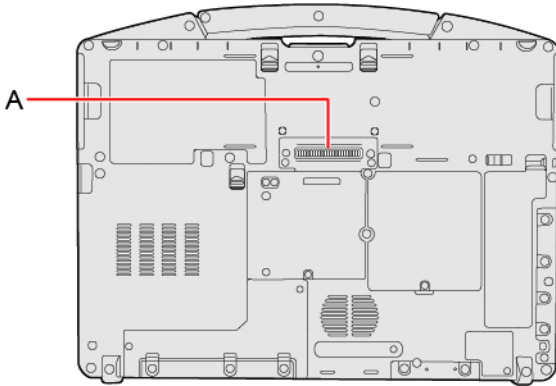

IMPORTANT

- Connect the AC adaptor always when using the port replicator.
- The driver of the port replicator is preinstalled in the computer.
- Connect or disconnect the port replicator while the computer power is turned off.
- To boot the computer from a commercially available optical drive, be sure to connect the USB drive to the USB port on the computer, not to the USB port on the port replicator.

NOTE

- Use only the specified port replicator (CF-VEB541 series).

Description of Parts

Read carefully this manual that described for each device when connecting each device to the port replicator.

IMPORTANT

- Do not touch the expansion bus connector or pins of the port replicator.

<Rear>

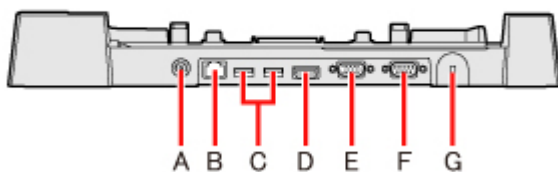

- A. DC-IN Jack
- B. LAN Port
- C. USB 3.1 (Type-A) Ports (2 ports)

D. HDMI Port

Connector for HDMI compatible digital display.

- On the monitor connected to the HDMI port or VGA port of the port replicator, content protection images by HDCP (High-bandwidth Digital Content Protection system) cannot be displayed.
- It is not compatible with the analog display.
- The display specifications of the maximum resolution, etc. that can be output differ according to the specifications of the device connected. For details, refer to the specifications of the device connected.

E. VGA Port

F. Serial Port

- It does not support serial mouse.

G. Security Slot

A Kensington cable can be connected.

- For more information, read the manual that comes with the cable.

<Front>

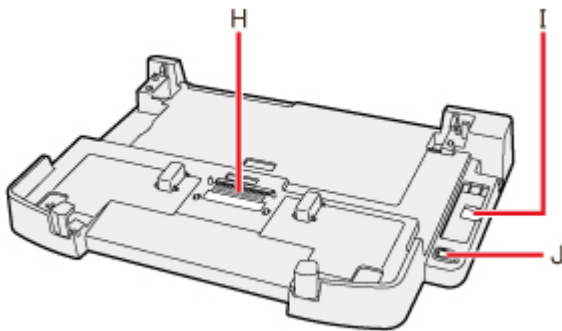

H. Expansion Bus Connector

This connects to the expansion bus connector on the bottom of the computer.

I. Lever

Slide the lever all the way back to release the computer.

J. Power Switch

This operates identically to the power switch on the computer.

<Left>

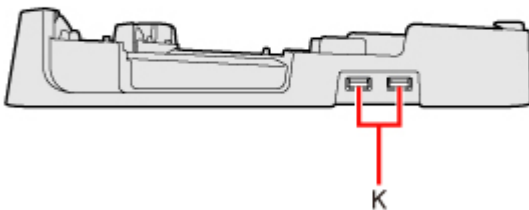

K. USB 2.0 Ports (2 ports)

Connecting/Disconnecting the Computer

IMPORTANT

- If an external display is connected to both the computer and port replicator, the computer may not be shut down properly.
-

Connecting

1. Turn off the computer.
2. Disconnect all the devices and cables and close the terminal cover and close the display.
3. Connect the AC adaptor to DC-IN jack of the port replicator.

Connect the AC cord to the AC adaptor, and connect to an AC outlet.

IMPORTANT

- Refer to the *OPERATING INSTRUCTIONS* accompanying computer for information on proper handling of the AC adaptor and AC cord.

4. Set firmly the front corners of the computer in the latches of the port replicator.

- Do not attempt to make connections if there is any object between the computer and the port replicator. Doing so could damage the computer and the port replicator.



5. Press the computer in the direction of the arrow and set firmly against the port replicator.

IMPORTANT

- When you connect the computer at an angle to the port replicator, it may not be set correctly.
- Do not allow your hand to get caught between the computer and the port replicator when setting the computer.

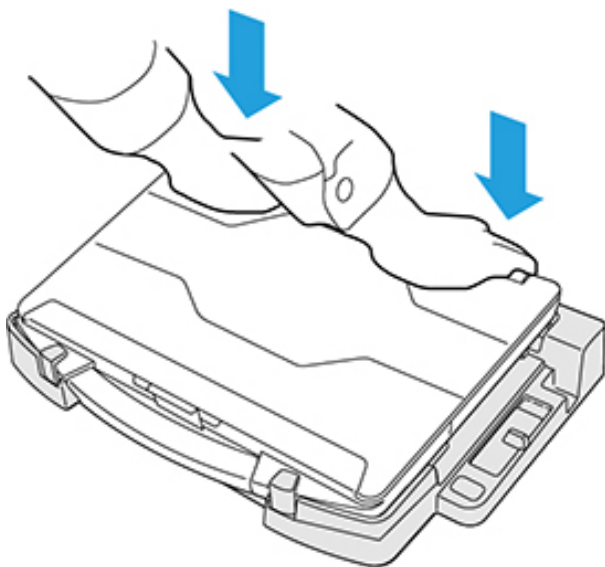

IMPORTANT

- Do not attempt to move the port replicator while connecting the computer to the port replicator.
- If the computer malfunctions while the port replicator is attached, disconnect the port replicator and check to see if the computer operates normally. If the computer operates normally, the port replicator may be malfunctioning. Contact Panasonic Technical Support.

NOTE

- See other chapters in this manual for connecting and setting USB devices, external displays and LAN.
- If the image of the external display connected to the port replicator has stopped, remove the computer from the port replicator, and then reconnect it.

Disconnecting

1. Turn off the computer and close the display.
2. Disconnect all the devices and cables and close the terminal cover and close the display.
3. Slide the lever all the way back.

The computer's connector disengages the expansion bus connector of the port replicator.

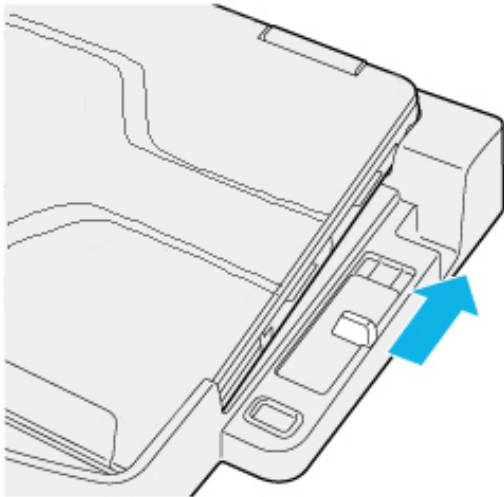

IMPORTANT

- After sliding the lever, do not suddenly release it. The lever may relock. Do not slide the lever while pressing against the computer from above. Doing so could damage the computer.
- If the computer malfunctions while the port replicator is attached, disconnect the port replicator and check to see if the computer operates normally. If the computer operates normally, the port replicator may be malfunctioning. Contact Panasonic Technical Support.

4. Lift up the computer to remove it from the port replicator.

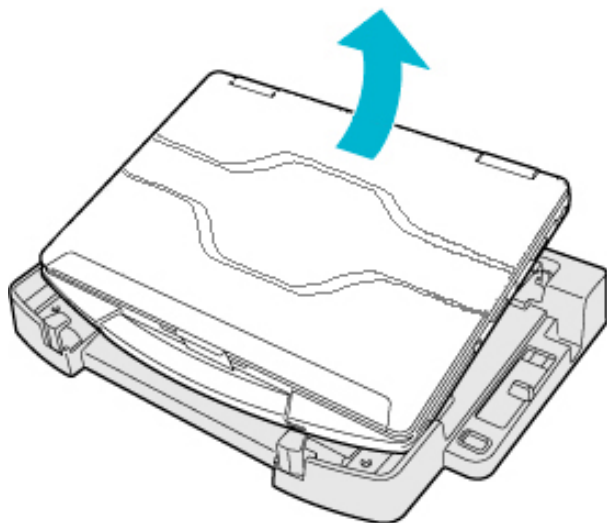

NOTE

-
- If it is difficult to disconnect the computer, push the lever while holding the computer from top for easy disconnection.
-

IMPORTANT

- When disconnecting the computer, do not hold the handle (see the location circled in the illustration).

Correct

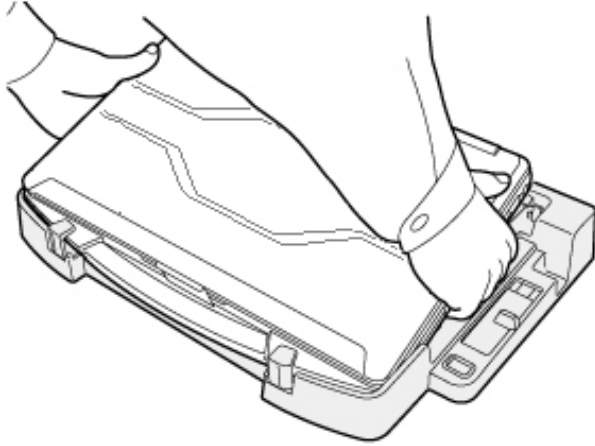

Incorrect

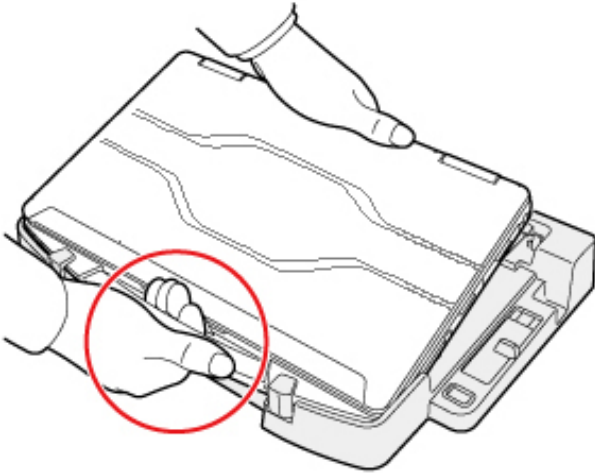

Battery Charger

The battery charger is designed for charging the battery pack for the Panasonic computer series. To recharge a battery pack, you will need the AC adaptor and AC cord included with this product.

Read both this Operating Instructions and the computer's Operating Instructions before using.

Description of Parts

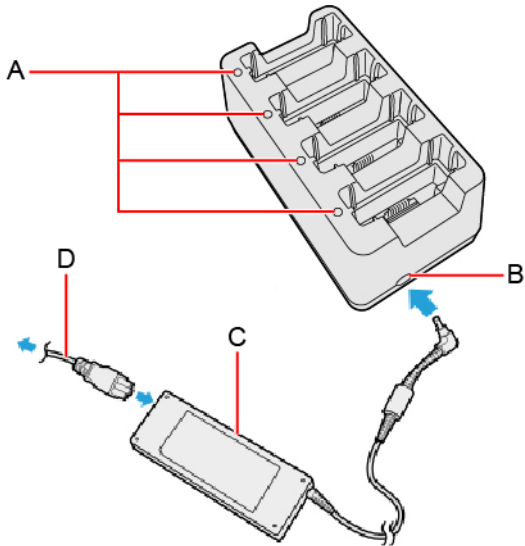

A. Battery Indicator (1 to 4)

B. DC-IN Jack

C. AC adaptor

Clean the dust and other debris of the connector regularly.

D. AC cord

IMPORTANT

- The AC cord may vary depending on the country.
- Use only the specified AC adaptor with this product.

Indicators

The power indicator on the battery charger lights green when the power is being supplied (when the adaptor is connected).

Battery Indicator	Battery status
Not lit	The battery pack is not inserted or not being charged.
Orange	Charging is in progress.
Green	The battery is fully-charged.
Blinking red	The battery pack or the charging circuit is not operating properly.
Blinking orange	The battery cannot be charged temporarily due to the following reasons: <ul style="list-style-type: none">• Its internal temperature is out of the acceptable range.

Charging the battery pack

1. Connect the AC Adaptor.
2. Insert the battery pack(s).

Insert the battery pack firmly with its battery connector (B) facing the indicator (A) of the charger.

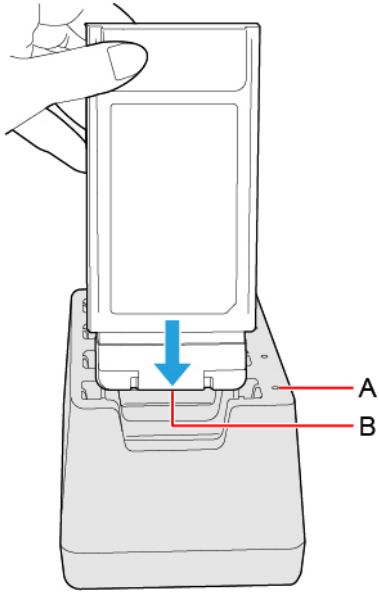

IMPORTANT

- Do not insert the battery pack at an angle. The terminal of the battery charger may be damaged.

Incorrect

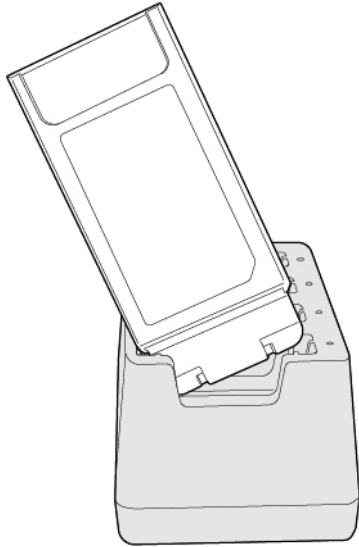

- If the battery pack got lodged in the slots, push the middle of the battery pack.
-

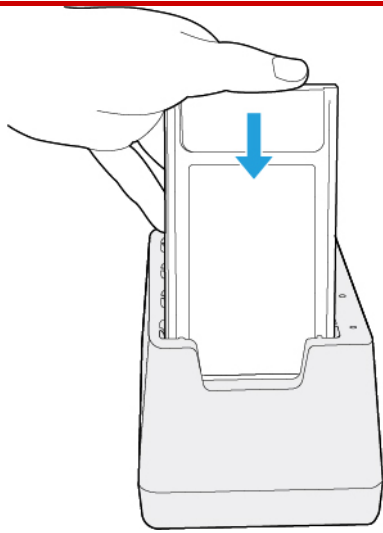

NOTE

- The battery indicator lights when the battery pack is properly inserted with the AC adaptor connected.
 - Four battery packs can be inserted simultaneously. Each of them can be inserted in any slot.
 - When removing the battery pack, pull it out in the opposite direction of attaching the battery pack.
 - Charging begins automatically.
 - The battery pack or battery charger will become somewhat warm during normal use. This is not a malfunction.
-

Troubleshooting





Refer to the following instructions when a problem occurs. If the remedies indicated in the chart do not solve the problem, contact Panasonic Technical Support.

For a software problem, refer to the instruction manual of the software.



- Refer to [Checking the Computer's Usage Status](#).





Starting Up / Sleep / Hibernation / Resume

<p>Cannot start up. The power indicator or battery indicator is not lit.</p>	<ul style="list-style-type: none"> • Connect the AC adaptor. • Insert a fully charged battery. • Remove the battery pack and the AC adaptor, and then connect them again. • Even if the AC adaptor and battery pack are correctly connected, if the battery indicator is not lit, the AC adaptor protection function may be operating. Disconnect the AC cord, wait three minutes or more, and reconnect the AC cord. • If a device is connected to the USB port, disconnect the device, or set [USB Port and Port Replicator] or [Legacy USB Support] to [Disabled] in the [Advanced] menu of the Setup Utility. • Press « Fn » + « F8 » to turn off the concealed mode.
<p>After adding or changing the RAM module, the power is turned on but nothing is displayed on the screen.</p>	<ul style="list-style-type: none"> • Turn off the computer and remove the RAM module, then confirm whether the RAM module has compliant to specification. When the RAM module has conformed to specification, install it again.
<p>Cannot turn on the computer. The computer does not resume from sleep. (The power indicator blinks rapidly in green.)</p>	<ul style="list-style-type: none"> • Leave it in an environment of 5 °C {41 °F} or higher temperature for about an hour, then turn on the power again.
<p>It takes time for the power indicator to light up.</p>	<ul style="list-style-type: none"> • If the power switch is pressed immediately after the battery pack has been mounted on the computer, and while the AC adaptor is not connected, it may take about five seconds before the power indicator lights up and the computer turns on. This is because the computer is checking the remaining battery charge; it is not a malfunction.
<p>"Remove disks or other media. Press any key to restart" or a similar message appears.</p>	<ul style="list-style-type: none"> • If a device is connected to the USB port, disconnect the device, or set [USB Port and Port Replicator] or [Legacy USB Support] to [Disabled] in the [Advanced] menu of the Setup Utility. • If the problem persists after removing the disk, it may be a flash memory failure. Contact Panasonic Technical Support.
<p>Windows startup and operation is slow.</p>	<ul style="list-style-type: none"> • Start the Setup Utility ( Setup Utility) to return the Setup Utility settings (excluding the passwords) to the default values. Start the Setup Utility and make the settings again. (Note that the processing speed depends on the application software, so this procedure may not make Windows faster.) • If you installed a resident software after purchase, turn off the residence.
<p>Cannot resume.</p>	<ul style="list-style-type: none"> • One of the following operations may have been carried out. Press the power switch turn on the computer. Data not saved will be lost. <ul style="list-style-type: none"> • In sleep mode, the AC adaptor or battery pack was disconnected, or a peripheral was connected or disconnected. • The power switch was pressed for four seconds or longer to forcibly turn off the computer. • The battery is exhausted. Sleep and hibernation consumes some power.

Other startup problems.	<ul style="list-style-type: none"> • Start in the Setup Utility ( Setup Utility) to return the Setup Utility settings (excluding the passwords) to the default values. Start the Setup Utility and make the settings again. • Remove all peripheral devices. • Check to see if there was a disk error. <ol style="list-style-type: none"> 1. Remove all peripheral devices including an external display. 2. Right-click  (Start) - [File Explorer]. 3. Click [This PC]. 4. Right-click [Windows (C:)], and click [Properties]. 5. Click [Tools] - [Check]. <ul style="list-style-type: none"> • A standard user needs to enter an administrator password. 6. Follow the on-screen instructions.
Cannot turn off the computer.	<ul style="list-style-type: none"> • Remove all peripherals. • It may take 1 or 2 minutes to turn off the computer.
Cannot enter sleep or hibernation.	<ul style="list-style-type: none"> • Remove USB devices temporarily. If the problem persists, restart the computer. • It may take 1 or 2 minutes to enter sleep or hibernation. • The computer does not enter sleep or hibernation immediately after resuming. Wait approximately 1 minute.
Cannot enter sleep or hibernation automatically.	<ul style="list-style-type: none"> • Disconnect peripheral devices. • If you connect to a network using wireless LAN function, select the profile and connect to the access point ( Disabling/Enabling Wireless Communication). • If you do not use wireless LAN function, turn off wireless LAN function ( Disabling/Enabling Wireless Communication). • Make sure that you are not using any software that regularly accesses the flash memory.

Entering Password

Forgot the password.	<ul style="list-style-type: none"> • Supervisor Password or User Password: Contact Panasonic Technical Support. • Administrator password: <ul style="list-style-type: none"> • If you have a password reset disk, you can reset the administrator password. Set the disk and enter any wrong password, then follow the on-screen instructions and set a new password. • If you do not have a password reset disk, reinstall ( Installing Software) and set up Windows, and then set a new password.
Even after entering the password, password input screen is displayed again.	<ul style="list-style-type: none"> • The computer may be in ten-key mode. If the NumLk indicator  lights, press << Num Lock>> to disable the ten-key mode, and then input. • The computer may be in Caps Lock mode. If the Caps Lock indicator  lights, press << Caps Lock>> to disable the Caps Lock mode, and then input. • Enter the password using the same keyboard that was used to set the administrator password or user password, as the key layouts of the on-screen keyboard and some external keyboards may differ.





<p>[Enter Password] does not appear when resuming from sleep/hibernation.</p>	<ul style="list-style-type: none"> • Select [Enabled] in [Password On Resume] in the [Security] menu of the Setup Utility. • The Windows password can be used instead of the password set in the Setup Utility. <p>To add a password, set up the following.</p> <ol style="list-style-type: none"> 1. Click  (Start) -  (Settings) - [Accounts]. 2. Click [Sign-in options], and click [Add] under “Password”. 3. Create a password. 4. Click [Next]. 5. Click [Finish]. 6. Select [Every Time] under “Require sign-in”.
<p>Cannot sign in to Windows using the face recognition for Windows Hello outdoors.</p>	<ul style="list-style-type: none"> • If you have registered the face recognition indoors, you may not sign in to Windows using the face recognition outdoors. In such cases, please add Windows Hello face recognition outdoors. Perform the following procedure. <ol style="list-style-type: none"> 1. Sign in to Windows. 2. Click  (Start) -  (Settings) - [Accounts]. 3. Click [Sign-in options]. 4. Click [Improve recognition] under “Windows Hello” and then click [Get started]. 5. “Making sure it’s you” is displayed, input PIN number. 6. Since additional registration of face recognition starts, follow the on-screen instructions. • If you cannot register the face recognition outdoors properly, try to take the following measures. <ul style="list-style-type: none"> • In the shade, register your face with your back against the wall that does not reflect the light.

Display



<p>No display.</p>	<ul style="list-style-type: none"> • The external display is selected. Press $\ll \text{Fn} \gg + \ll \text{F3} \gg$ or $\ll \img alt="Display icon" data-bbox="745 510 775 535"/> \gg + \ll \text{P} \gg$ to switch the display. Then click the display mode. • When using an external display, <ul style="list-style-type: none"> • Check the cable connection. • Turn on the display. • Check the settings of external display. • The display is turned off by the power-saving function. The screen returns to the original state when you operate keyboard, touchpad, or touchscreen (only for model with touchscreen). When operating the keyboard, press a key that does not affect the computer operation, such as $\ll \text{Ctrl} \gg$. • The computer entered sleep or hibernation by the power-saving function. To resume, press the power switch.
<p>The screen is dark.</p>	<ul style="list-style-type: none"> • The screen is darker when the AC adaptor is not connected. Press $\ll \text{Fn} \gg + \ll \text{F2} \gg$ and adjust the brightness. As you increase the brightness, battery consumption increases. You can separately set the brightness for when the AC adaptor is connected and when not connected. • Press $\ll \text{Fn} \gg + \ll \text{F8} \gg$ to turn off the concealed mode. • Under factory default settings, the brightness of the display screen will adjust automatically based on the ambient light detected by the ambient light sensor. You can adjust the settings for this sensor. ( Automatic brightness adjustment)
<p>The screen is disordered.</p>	<ul style="list-style-type: none"> • Changing the number of display colors and resolution may affect the screen. Restart the computer. • Connecting/disconnecting an external display may affect the screen. Restart the computer. • Resuming from sleep or hibernation may affect the screen of the external display. Restart the computer.

During Simultaneous display, one of the screens becomes disordered.	<ul style="list-style-type: none"> When using the Extended Desktop, use the same display colors for the external display as those used by the LCD. If you continue to experience problems, try changing the display.
The external display does not work normally.	<ul style="list-style-type: none"> If the external display does not support the power saving function, it may not work normally when the computer enters the power saving mode. Turn off the external display. Simultaneous display cannot be used until Windows startup is complete (during Setup Utility, etc.).
The screen does not become bright.	<ul style="list-style-type: none"> The brightness is set low to avoid malfunction where surrounding temperature is high. For proper operating temperature ( Specifications).
There are red, green, or blue dots on the screen, or there is unevenness in colors and brightness on the screen.	<p>The following are not malfunctions.</p> <ul style="list-style-type: none"> Although advanced high-precision technologies are used in the production of color LCD screens, 0.002 % or less of the picture elements may be dark or remain constantly lit (i.e., more than 99.998 % of elements function properly). Due to the natural characteristics of LCD screens, you may notice unevenness in colors and brightness depending on your angle of view. Hues may also vary by product.

Sound





No sound.	<ul style="list-style-type: none"> Press « Fn » + « F4 » or « Fn » + « F6 » to cancel mute. Turn off the concealed mode. Restart the computer. Beeping sounds are not emitted by this device.
Distorted sound.	<ul style="list-style-type: none"> Performing « Fn » key combinations sometimes causes sound distortion. Stop and restart playback.
Cannot change the volume by pressing « Fn » + « F5 » or « Fn » + « F6 » .	<ul style="list-style-type: none"> Activate the Windows sound function. When it is not active, the volume does not change even if slide bar is displayed.
The microphone volume is small/large.	<ul style="list-style-type: none"> Adjust the volume of the microphone according to the following steps.: <ol style="list-style-type: none"> Right-click  (Speakers) on the task tray, and click [Sounds]. Click [Recording] - [Microphone Array] - [Properties], and then move the slider () to adjust the volume of [Microphone Array] and/or [Microphone Boost] in [Levels].
Cannot record with microphone.	<ul style="list-style-type: none"> Use a condenser microphone.
When signing in (e.g., resuming the computer), audio is distorted.	<ul style="list-style-type: none"> Perform the following steps to change the audio settings to prevent audio output. <ol style="list-style-type: none"> Right-click  (Speakers) on the task tray, and click [Sounds]. Remove the check mark from [Play Windows Startup sound].
The feedback noise may occur .	<ul style="list-style-type: none"> To stop microphone's monitoring output. <ol style="list-style-type: none"> Right-click  (Speakers) on the task tray, and click [Sounds]. Click [Recording] - [Microphone Array] - [Properties], and then remove a check mark for [Listen to this device] in [Listen].

Keyboard

Only numbers can be input.	<ul style="list-style-type: none"> When the indicator  is on, the keyboard is in ten-key mode. Press « Num Lock » to cancel.
Only capital letters can be input.	<ul style="list-style-type: none"> When the indicator  is on, the keyboard is in Caps Lock mode. Press « Caps Lock » to cancel.

<p>Cannot enter special characters (ß, à, ç, etc.) and symbols.</p>	<ul style="list-style-type: none"> • Use the character map. <p>1. Click  (Start) - [Windows Accessories] - [Character Map].</p>
---	---

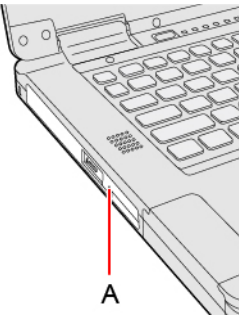

Disc Operation (only for model with optical disc drive)

<p>The optical disc drive does not work normally.</p>	<ul style="list-style-type: none"> • Set [Optical Drive] to [Enabled] in the [Advanced] menu of the Setup Utility. • Clean the lens ( Optical disc drive handling care). • Check the disc condition ( Disc handling care).
<p>Cannot play back TV programs recorded on a commercial DVD recorder.</p>	<ul style="list-style-type: none"> • Finalize the disc on the DVD recorder when the program was recorded in video mode on DVD-R/RW or in VR mode on DVD-RW.
<p>A blue background appears on the screen when playing an MPEG image.</p>	<ul style="list-style-type: none"> • You opened the optical disc drive or removed the MPEG disc while it was operating. Re-insert the MPEG disc and close the optical disc drive.
<p>The optical disc drive vibrates excessively or makes noise.</p>	<ul style="list-style-type: none"> • Insert the disc correctly. • Check the disc condition ( Disc handling care). • When writing to CD-R/RW using Power2Go, you can minimize vibration while writing by using the writing speed at [10x] or less.
<p>Cannot eject a disc.</p>	<ul style="list-style-type: none"> • Turn on the computer. • To remove a disc when the computer is powered off, insert a pin of 1.3 {±0.05} mm in diameter into the emergency hole (A). (When the diameter of the pin is smaller than this, insert the pin slightly downward.) Pushing it completely to the end will free the tray so that it can be pulled out. <div style="text-align: center;">  <p>A</p> </div> <ul style="list-style-type: none"> • If a disc with fingerprints or other dirt is used, you may not be able to remove it. Use a clean disc. ( To clean discs)
<p>The disc tray does not close.</p>	<ul style="list-style-type: none"> • Do not touch the eject button when closing the tray.
<p>Other disc operation problems.</p>	<ul style="list-style-type: none"> • Use another drive or media.

Network

<p>Cannot connect to a network.</p>	<ul style="list-style-type: none"> • Set the device ([LAN] / [LAN (2nd)] / [Wireless LAN] / [Wireless LAN (2nd)] / [Wireless WAN]) to [Enabled] in the [Advanced] menu of the Setup Utility.
-------------------------------------	---

Cannot check the computer's MAC address.



- Follow the steps below.
 - Click  (Start) -  (Settings).
 - Click [Network & Internet] - [Status] - [View your network properties]. Properties of each device appears. Write down the 12-digit address (alphanumeric) that appears for "Physical address (MAC):" rows of each devices. The names of each of the devices are as follows.

Device	Connection name
Wireless WAN	Cellular
Wired LAN	Ethernet
Wired LAN (2nd)	Ethernet 2
Wireless LAN	Wi-Fi
Wireless LAN (2nd)	Wi-Fi 2
Bluetooth	Bluetooth Network Connection

*The content displayed will vary depending on the device and model.





- Click  to close the window.

Wireless Communication (only for model with wireless LAN/2nd wireless LAN/Bluetooth/wireless WAN)

<p>Cannot connect to a network.</p>	<ul style="list-style-type: none"> Set the device ([Wireless LAN] / [Wireless LAN (2nd)] / [Wireless WAN] of [Wireless Configuration]) to [Enabled] in the [Advanced] menu of the Setup Utility ( Wireless Configuration). Confirm the airplane mode is Off. To turn off the airplane mode ( Using airplane mode). If this computer cannot be connected to an IEEE802.11a network, confirm "Enabling/Disabling the Wireless LAN Standard IEEE802.11a (802.11a)". Restart the computer.
<p>Access point is not detected.</p>	<ul style="list-style-type: none"> Shorten the distance between the computer and the access point, and try the detection again. Confirm the following settings: <ul style="list-style-type: none"> [Wireless LAN] / [Wireless LAN (2nd)] in the [Advanced] menu of the Setup Utility <ul style="list-style-type: none"> Confirm that [Wireless LAN] / [Wireless LAN (2nd)] of [Wireless Configuration] is set to [Enabled]. Check the channel being used by the access point.
<p><Only for model with wireless WAN> Cannot communicate.</p>	<ul style="list-style-type: none"> Confirm the following settings: <ul style="list-style-type: none"> [Wireless WAN] in the [Advanced] menu of the Setup Utility <ul style="list-style-type: none"> Confirm that [Wireless WAN] of [Wireless Configuration] is set to [Enabled]. Confirm that the nanoSIM card is inserted correctly. <p>If communication is not established after proceeding with the above remedies, the wireless WAN device may not be correctly recognized. Restart the computer.</p>

Connecting Peripherals

<p>An error occurs while installing the driver.</p>	<ul style="list-style-type: none"> When you install a driver of card or peripheral device, make sure that the driver is compatible with the operating system. If it is not compatible, malfunction may occur. For information about the driver, contact the manufacturer of the peripheral device.
---	---

<p>A peripheral device does not work.</p>	<ul style="list-style-type: none"> • Install the driver. • Contact the manufacturer of the device. • When operation resumes from sleep or hibernation, devices such as an external mouse and cards may not function properly. In this case, restart the computer or reinitialize the device. • When  is displayed in the Device Manager, remove and insert the device. If the problem persists, restart the computer. • When you set [USB Port and Port Replicator] to [Disabled] in the [Advanced] menu of the Setup Utility, USB ports of port replicator are also disabled. • The computer may not recognize the connection/removal of some devices, or may not operate normally with some devices. <ul style="list-style-type: none"> 1. Right-click  (Start) - [Device Manager]. 2. Select the device, and remove the check mark for [Allow the computer to turn off this device to save power] in [Power Management]. (This item may be unavailable for some types of devices.) • In the case that a USB device does not work, remove the USB device and connect it again or connect the USB device to another port. • Depending on the peripheral devices, it may not operate normally when connected to the USB port with the continuous power supply function.
<p>The connected mouse does not work.</p>	<ul style="list-style-type: none"> • Check the mouse connection. • Install the driver compatible with the connected mouse. If the mouse does not work even after installing the driver, set [Touch Pad] to [Disabled] in the [Main] menu of the Setup Utility.
<p>The RAM module is not recognized.</p>	<ul style="list-style-type: none"> • Insert the RAM module correctly. • Use the compatible RAM module ( Specifications). • Check the [Information Menu] in the Setup Utility. If the RAM module is not recognized, turn off the computer and reinsert the RAM module.
<p>You do not know the address map for IRQ, I/O port address, etc.</p>	<ul style="list-style-type: none"> • You can check with the following procedure. <ol style="list-style-type: none"> 1. Right-click  (Start) - [Device Manager]. 2. Click [View] - [Resources by type].
<p><Only for model with Serial Port> The device connected to the serial port does not work.</p>	<ul style="list-style-type: none"> • Check the connection. • The device driver may not work. Refer to the instruction manual of the device. • Do not connect 2 mouse devices simultaneously. • The I/O and IRQ you can use vary depending on the device. If the setting does not work, try other settings in the Setup Utility.
<p><Only for model with dedicated GPS / GPS on wireless WAN> GPS does not work.</p>	<ul style="list-style-type: none"> • You can check the GPS status. ( GPS) • Set airplane mode to OFF. <ul style="list-style-type: none"> • Airplane mode*1 <ul style="list-style-type: none"> • Confirm that Wireless LAN (Wi-Fi) is [On]. • Confirm that Wireless WAN (Cellular) is [On]. • If a USB 3.1 compatible device is used, GPS information may not be correctly received. In this case, do any of the following. <ul style="list-style-type: none"> • Connect the USB device to the USB 3.1 port. • Use an extension cable (separately sold) compatible with USB 3.1. • If an external antenna for GPS can be used, use the external antenna, and keep some distance between the external antenna and the USB device.

<p><Only for model with LAN/2nd LAN> LAN transmission speed slows down noticeably.</p> <p><Only for model with wireless LAN/2nd wireless LAN> Wireless LAN connection is cut.</p>	<ul style="list-style-type: none"> Change the power plan to [Best performance]. ( Configuring Power Saving Settings)
---	--

*1 : Screen messages are explained in [English (United States)].

(Depending on the language preference, some screen messages in these instructions are different from the actual screen messages. For example, [Flight mode]/[Wi-Fi]/[Wi-Fi 2] may be displayed instead of [Airplane mode]/[Wi-Fi]/[Wi-Fi 2] in some language preference.)

Touchpad / Touchscreen (only for model with touchscreen)

<p>The pointer does not work.</p>	<ul style="list-style-type: none"> Connect the external mouse correctly. Restart the computer using the keyboard. If the computer does not respond to keyboard commands, read “No response”.
<p>Cannot input using the touchpad.</p>	<ul style="list-style-type: none"> Set [Touch Pad] to [Enabled] in the [Main] menu of the Setup Utility. The touchpad may be disabled by some mouse drivers. Check your mouse's operating instructions. Press both buttons of touchpad at same time. The touchpad is disabled. Press << Fn >> + << Esc >> to enable.
<p><Only for model with touchscreen> Cannot point the correct position using the pen (included) and fingers.</p>	<ul style="list-style-type: none"> Perform the Calibrating the Screen.

microSD Memory Card

<p>Cannot use a microSD Memory Card.</p>	<ul style="list-style-type: none"> Set [microSD Card Slot] to [Enabled] in the [Advanced] menu of the Setup Utility. This computer does not support the maximum speed some types of microSD / microSDHC / microSDXC Memory Cards guarantee.
--	---

Smart Card (only for model with Smart Card slot)

<p>Cannot use a Smart Card.</p>	<ul style="list-style-type: none"> Insert the Smart Card correctly. Set [Smart Card] to [Enabled] in the [Advanced] menu of the Setup Utility. To use a Smart Card, you need a specified software and driver.
---------------------------------	--



Fingerprint Reader (only for model with Fingerprint Reader)



<p>The reader does not enroll or authenticate my fingerprint.</p>	<ul style="list-style-type: none">• If pop-up or other messages appear on the desktop screen, fingerprint entry may be inhibited temporarily. In such cases, click outside of the Fingerprint Authentication window, and then click again back inside it.• The reader enrolls or authenticates no fingerprint, or performs authentication poorly, despite the correct way of finger sliding when your finger is in any of the conditions stated below:<ul style="list-style-type: none">• Rough skin, or injured finger (with a cut or a skin inflammation)• Extremely dry• Soiled with mud or oil• Fingerprint has been worn and has faded• Wet with water or sweat<You can improve enrolling and authentication sensitivity by taking the following steps when any of the conditions described above exists><ul style="list-style-type: none">• Wash your hands or wipe them dry.• Use a different finger for registration or authentication.• Treat your finger with a hand cream when it is rough skin or dry.• Clean the fingerprint reader. For further information, refer to Fingerprint Reader Handling.• The fingerprint reader may be malfunctioning when it continues to perform poorly after the steps described above have been performed. Contact Panasonic Technical Support.
<p>User cannot use enrolled finger. (e.g. injury)</p>	<ul style="list-style-type: none">• If none of your enrolled fingers can be used, follow this procedure:<ol style="list-style-type: none">1. When fingerprint authentication screen is displayed, switch to password input by pressing the « Esc » key.2. Sign in to Windows. You can always access the computer by using your Windows sign in password.3. Add another finger, or uninstall the fingerprint authentication function.

User Switching

<p>Some applications do not work properly.</p>	<ul style="list-style-type: none">• When switching to a different user without signing out, some applications do not work properly. In this case, sign out the other users.
--	---

Others

<p>Although the computer is turned on, the following problems is occurred.</p> <ul style="list-style-type: none">• The indicators does not light.• No sound.• Screen is dark.	<ul style="list-style-type: none">• The concealed mode is enabled ( Key Combinations).
<p>No response.</p>	<ul style="list-style-type: none">• Open Task Manager and close the software application.<ol style="list-style-type: none">1. Right-click  (Start) - [Task Manager].• An input screen (e.g., password input screen at startup) may be hidden behind another window. Use « Alt » + « Tab » to check.• Shut down by pressing and holding the power switch for 4 seconds or longer, and turn on the computer and open the application again.• If Windows runs correctly, but the application software does not start, uninstall the failing application software, then reinstall it. To uninstall, perform the procedure below.<ol style="list-style-type: none">1. Right-click  (Start) - [Apps and Features] - [Apps & features].2. Select the program you want to uninstall, and click [Uninstall].

A motion image file cannot be played using Windows Media Player and the message "Codec required" appears.	Some motion image files require a Codec that is not installed as standard. In this case, connect to the Internet and try playback of the file again. The Codec may automatically be downloaded so you may be able to play it.
The date and time are incorrect.	<ul style="list-style-type: none"> • Make the correct settings. <ol style="list-style-type: none"> 1. Click  (Start) -  (Settings) - [Time & Language] - [Date & time], and select [Off] in "Set time automatically". 2. Click [Change], and then set the day and time. 3. Click [Change], and select [On] in "Set time automatically". • If the problem persists, the internal clock battery may need to be replaced. Contact Panasonic Technical Support.
"Battery not exist" is displayed.	Battery goes to sleep if the battery level is about 5 %, may be displayed such as "Not exist" or "Not use" is not a malfunction. Connect the AC adaptor for a while.



Checking the Computer's Usage Status

You can check the computer's usage status in the PC Information Viewer. You may need this information when calling Panasonic Technical Support for advice.

NOTE

- This computer periodically records the management information of the flash memory, etc. The maximum data volume for each record is 1024 bytes. The information is only used for estimating the cause when the flash memory goes down by any possibility. They are never sent to outside via network nor used for any other purpose except for the purpose described the above.
To disable the function, add the check mark for [Disable the automatic save function for management information history] in [Hard Disk Status] of PC Information Viewer, and click [OK].
 - A standard user needs to enter an administrator password.
- Depending on your network environment, it may take 1 minute to start up the PC Information Viewer.

Launching PC Information Viewer



1. Click  (Start) -  (Panasonic PC Settings Utility) -  (Support) -  (System) - [Launch PC Information Viewer].
2. Select the item to display the detailed information.

To save the information as a text file

1. Run the PC Information Viewer and display the information you wish to save.
2. Click [Save].
 - To save the item that is displayed
Click [Save only the information displayed] and click [OK]. Some of the hidden information on the screen, which cannot be shown without scrolling the screen, will be saved, too.
 - To save all items
Click [Save all the information] and click [OK].
In the case of [Hard Disk Status], if you do not add the check mark for [Disable the automatic save function for management information history], the records already recorded are also saved.
3. Select the folder to save the information, input the file name, and then click [Save].

To save a copy of the screen as an image file

To save a copy of the screen as an image file, perform the following steps.

1. Display the screen you want to save.
2. Press  + .

The screen image is saved in "Screenshots" folder under "Pictures" folder.

Hardware Diagnostics

If it appears that the hardware installed in this computer is not operating properly, you can use the PC-Diagnostic Utility to determine whether or not there is a problem.

If the utility discovers a problem in the hardware, contact Panasonic Technical Support.

Software cannot be checked using this utility.

Hardware that can be checked using the PC-Diagnostic Utility

- CPU/System
- RAM XXXX MB
- Storage XXX GB
- Optical Drive (Only for model with optical disc drive)
- SOUND*1
- USB
- SD
- Keyboard
- Touch Pad
- Touch Screen (Only for model with touchscreen)
- Wireless LAN (Only for model with wireless LAN)
- Video
- Wired LAN
- Serial Port (Only for model with serial port)
- Wireless WAN (Only for model with wireless WAN)
- Bluetooth (Only for model with Bluetooth)
- GPS (Only for model with dedicated GPS)
- Smart Card (Only for model with Smart Card slot)

*1 : When the PC-Diagnostic Utility is running a loud beep will sound, so do not use headphones as this time. (The beep will not sound if mute is using in Windows or [Sound] is turned off in [Concealed Mode Configuration].)

NOTE

- When the video diagnostic check is running, the display may be distorted. This is not malfunction.

Regarding the PC-Diagnostic Utility

- We recommend that you use the touchpad for operations. When not using the touchpad, you can operate using the internal keyboard instead. Do not use the touchscreen.

Operations	Touchpad/External mouse operations	Internal keyboard operations
Select icon	Place the cursor above the icon	Press « Space », and then press « → » « ← » « ↑ » « ↓ » ( (close) cannot be selected)
Click the icon	Touch or click (right click cannot be used)	Press « Space » above the icon

Operations	Touchpad/External mouse operations	Internal keyboard operations
Complete the PC-Diagnostic Utility and then restart the computer	Click  (close)	Press « Ctrl » + « Alt » + « Del »

- If the touchpad does not operate properly, press « Ctrl » + « Alt » + « Del » to restart the computer, or press the power switch to turn the power off, and then restart the PC-Diagnostic Utility.

Running the Diagnostic Check



Run this utility using the default settings in the Setup Utility.

If the Setup Utility or other settings will not allow hardware to be executed, the hardware icon will be displayed in gray.

1. Connect the AC adaptor, and be enabled the wireless function.

During the diagnostic check, do not remove the AC adaptor, or attach any peripheral devices.

2. Start the Setup Utility.

1. Click  (Start) -  (Settings) - [Update & Security] - [Recovery].
2. Click [Restart now] under “Advanced startup”^{*2}.
3. Click [Troubleshoot] - [Advanced options] - [UEFI Firmware Settings] - [Restart].

The computer restarts, and the Setup Utility screen appears.

- If the password is requested, enter the Supervisor Password.
- If you are using the computer after changing the settings from the status at the time of purchase, we recommend that you make a note of the settings that are changed.

^{*2} : Screen messages are explained in [English (United States)].

(Depending on the language preference, some screen messages in these instructions are different from the actual screen messages. For example, [Advanced start-up] may be displayed instead of [Advanced startup] in some language preference.)

3. Press « F9 ».

At the confirmation message, select [Yes] and press « Enter ».

4. Press « F10 ».

At the confirmation message, select [Yes] and press « Enter ».

The computer will restart.

5. Press « F2 » to display Setup Utility.



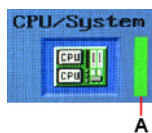

6. Select the [Exit] menu, and then select [Diagnostic Utility].

When the PC-Diagnostic Utility starts up, it will automatically begin the diagnostic check for all hardware components.

- If the password is requested, enter the password.
- The touchpad and the internal keyboard may not be used when each hardware checking is running. While checking, a vertical green progress bar (A) is displayed on the right side of the hardware icon.



- You can perform the following operations by selecting the icons on the screen:

-  : Start the diagnostic check from the beginning.
-  : Stop the diagnostic check (After the process is stopped, you cannot resume it by selecting ).
-  : Display help (click the screen or press « Space » to return to the original screen).

- You can check the status and results of the diagnostic check via the progress bar displayed on the right of the hardware icon.

- When the bar is progressing: The diagnostic check is in progress.
During memory diagnostic check, the display may stop for a long period of time. Wait until the process is complete.
- When the bar is green: No problems discovered.
- When the bar is red: Problems discovered.
- When the bar is yellow: The diagnostic check has been stopped or is complete.

NOTE

- Using the following procedure, you can run a diagnostic check on a specified hardware component, or run an extended diagnostic check (The extended diagnostic check is only specified). The extended diagnostic check is more detailed, and so requires a longer period of time to run.

1. Click  to stop the diagnostic check, and click the hardware icon to configure the diagnostic.

- Standard display (B): Perform diagnostic check.

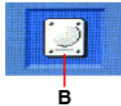

- "Full" display (C): Perform extended diagnostic check. ("Storage", "Keyboard", "Touch Pad" and "Touch Screen" only)



- Gray display (D): Do not perform diagnostic check.

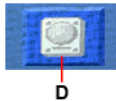

2. Click  to start the diagnostic check.

- Display during diagnostic check (E): Diagnostic check is in progress.

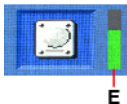

7. When all the hardware has been checked, confirm the diagnostic check results.

If the display is red and the message "TEST FAILED" is displayed, you can assume that there is a problem with the computer's hardware. Confirm which hardware component is displayed as red, and contact Panasonic Technical Support.

If the display is green and the message "TEST PASSED" is displayed, the computer's hardware is operating normally. Continue using the computer as it is. If the computer still does not operate properly, reinstall the software ( [Installing Software](#)).

NOTE

- If you run a memory diagnostic check after installing a new RAM module (sold separately) and the message "TEST FAILED" is displayed:

Remove the additional RAM module and run the diagnostic check again. If the message "TEST FAILED" is still displayed, you can assume that there is a problem with the internal RAM module.

8. After the diagnostic check is complete, click  (close), or press << Ctrl >> + << Alt >> + << Del >> to restart the computer.

When the Icon Becomes Gray and the Corresponding Device Cannot Be Checked

- **The device is disabled in the Setup Utility:**
Set the device to [Enabled] in the Setup Utility.

Reset your computer

If operations on the unit become unstable, we recommend refreshing Windows. This involves reinstalling the operating system while retaining personal files and settings (Personalization).

Preparation

- Remove all peripherals and microSD memory card, etc.
- Connect the AC adaptor and do not remove it until installation is complete.

1. Click  (Start) -  (Settings) - [Update & Security] - [Recovery].

2. Click [Get started] under "Reset this PC".

3. Select the option.

- [Keep my files]

Windows reinstallation can be completed in a short time (Approximately 30 minutes).

Applications and other items that do not come with this computer will be removed.

- [Remove everything]

Select [Yes] or [No] under the "Keep this PC set up for your workplace".

- [Just remove my files] (Approximately 30 minutes)

- [Remove files and clean the drive]

By fully cleaning, the deleted files cannot be recovered easily and the security level will be increased. The processing time will be longer (Approximately 50 minutes).

4. Follow the on-screen instructions.

After the reinstallation, the computer will restart.

- Do not interrupt installation, for example by turning off the computer or performing other operation. Otherwise installation may become unavailable as Windows may not start up or the data may be corrupted.

5. Perform Setup Windows ( **OPERATING INSTRUCTIONS - Read Me First**).

NOTE

- The date and time, and the time zone may not be correct. Be sure to set them correctly.

6. Perform Windows Update.

7. <Only for model with TPM> Clear TPM.

1. Right-click  (Start) - [Run], then input "tpm.msc" and click [OK].
2. Click [Clear TPM...] under "Actions" on the right of the "Trusted Platform Module (TPM) Management on Local Computer" screen.
3. Click [Restart] of the "Manage the TPM security hardware" screen.
TPM is cleared, and the computer will restart.

Installing Software

Installing software will return the computer to the default condition. When you install the software, the internal SSD data will be erased.

Back up important data to other media or an external flash memory before installation.

IMPORTANT

- **Do not delete the recovery partition on the SSD. If it has been deleted, the recovery disc could not be created.**

To check the recovery partition, perform the following methods.

1. Right-click  (Start) - [Disk Management].
 - A standard user needs to enter an administrator password.

Disk recovery

You can reinstall the OS that was pre-installed at the time of purchase.

IMPORTANT



- **If the recovery partition is deleted, you cannot perform flash memory recovery.**

If reinstallation using the method described in “Reset this PC” is not successful, follow the steps below.

Preparation

- Remove all peripherals and microSD memory card etc.
- Connect the AC adaptor and do not remove it until installation is complete.

1. Start the Setup Utility.

1. Click  (Start) -  (Settings) - [Update & Security] - [Recovery].
2. Click [Restart now] under “Advanced startup”.
3. Click [Troubleshoot] - [Advanced options] - [UEFI Firmware Settings] - [Restart].

2. Write down all of the contents of the Setup Utility and press « F9 » .

At the confirmation message, select [Yes] and press « Enter » .

3. Press « F10 » .

At the confirmation message, select [Yes] and press « Enter » . The computer will restart.

4. Press « F2 » or « Del » while “Panasonic” boot screen is displayed.

The Setup Utility starts up.

- If the password is requested, enter the Supervisor Password.

5. Select the [Exit] menu, then select [Recovery Partition] and press « Enter » .

Computer will restart.

6. Click [Recovery].

Click [CANCEL] to abort the operation.

7. Confirm the contents of “EULA”, and click [Accept.] if you continue.

8. Click [Quick Release Storage Drive : xxxxx].

9. Click [Recovery ALL Partitions.].

Installation starts according to the instructions on the screen. (It will take approximately several tens of minutes.)

- Do not interrupt installation, for example by turning off the computer or performing other operation. Otherwise installation may become unavailable as Windows may not start up or the data may be corrupted.

10. When the Ending process screen is displayed, click [Shutdown.] to turn off the computer.

11. Turn on the computer.

- If the password is requested, enter the Supervisor Password.
12. **Perform Setup Windows** ( **OPERATING INSTRUCTIONS - Read Me First**).
 13. **Start the Setup Utility and change the settings as necessary.**
 14. **<Only for model with TPM> Clear TPM.**

1. Right-click  (Start) - [Run], then input "tpm.msc" and click [OK].
2. Click [Clear TPM...] under "Actions" on the right of the "Trusted Platform Module (TPM) Management on Local Computer" screen.
3. Click [Restart] of the "Manage the TPM security hardware" screen.
TPM is cleared, and the computer will restart.

Using Recovery Disc

Use the Recovery Disc in the following conditions.

- You have forgotten the administrator password.
- Installation is not complete. The recovery partition in the flash memory may be broken.

Preparation

- Prepare the following items:
 - Recovery Disc (USB memory device can also be used as a recovery disc.) ( [Create a Recovery Disc](#))
 - Commercially available optical drive (only for model without optical disc drive)
- Remove all peripherals and microSD memory card etc. (except for the commercially available optical drive).
- Connect the AC adaptor and do not remove it until installation is complete.

1. **Start the Setup Utility.**
 1. Click  (Start) -  (Settings) - [Update & Security] - [Recovery].
 2. Click [Restart now] under "Advanced startup".
 3. Click [Troubleshoot] - [Advanced options] - [UEFI Firmware Settings] - [Restart].
2. **Write down all of the contents of the Setup Utility and press <<F9>> .**
At the confirmation message, select [Yes] and press <<Enter>> .
3. **Insert the media that was used to create the recovery disc.**
 - For DVD/BD media
 1. Connect the commercially available optical drive to the USB Port (only for model without optical disc drive).
 2. Set a disc into the optical disc drive or the commercially available optical drive.
 - For USB storage devices
 1. Connect the USB storage device used to create the recovery disc to the USB port.
4. **Press <<F10>> .**
At the confirmation message, select [Yes] and press <<Enter>> . The computer will restart.
5. **Press <<F2>> or <> while "Panasonic" boot screen is displayed.**
The Setup Utility starts up.
 - If the password is requested, enter the Supervisor Password.
6. **Select the [Exit] menu, and then select optical disc drive, commercially available optical drive or USB storage device in [Boot Override] and press <<Enter>> .**
The computer will restart.
7. **Click [Recovery].**
8. **Confirm the contents of "EULA", and click [Accept.] if you continue.**
9. **Click [Quick Release Storage Drive : xxxxx].**
10. **Click [Recovery ALL Partitions.].**
11. **Click [Remain Recovery Partition.].**

Follow the on-screen instructions.

12. **When the Ending process screen is displayed, remove the Recovery Disc and optical disc drive or commercially available optical drive and then click [Reboot].**

Follow the on-screen instructions.

13. **On the “Finish Recovery Process.” screen, click [Shutdown.].**
14. **Turn on the computer.**
15. **Perform Setup Windows ( OPERATING INSTRUCTIONS - Read Me First).**
16. **Start the Setup Utility and change the settings as necessary.**
17. **<Only for model with TPM> Clear TPM.**

1. Right-click  (Start) - [Run], then input “tpm.msc” and click [OK].
2. Click [Clear TPM...] under “Actions” on the right of the “Trusted Platform Module (TPM) Management on Local Computer” screen.
3. Click [Restart] of the “Manage the TPM security hardware” screen.

TPM is cleared, and the computer will restart.

Error Message

Follow the instructions below when an error message appears. If the problem persists or if the error message is not shown here, contact Panasonic Technical Support.

Error Message	Solution
Bad System CMOS	<p>An error has occurred in the memory of system settings. This occurs when the memory content is changed by an unexpected program operation, etc.</p> <ul style="list-style-type: none"> Start the Setup Utility and return the settings to the default values, and then change the settings as necessary. If the problem persists, the internal clock battery may need to be replaced. Contact Panasonic Technical Support.
System CMOS Checksum Error	
Invalid Year. System date restored to 01/01/20XX	<p>The date and time settings are not correct.</p> <ul style="list-style-type: none"> Start the Setup Utility and set the correct date and time. If the problem persists, the internal clock battery may need to be replaced. Contact Panasonic Technical Support.
Press F2 for Setup / F12 for LAN	<ul style="list-style-type: none"> Write down the error details and press « F2 » or « Del » to start the Setup Utility. Change the settings if necessary.
Warming up the system (up to 30 minutes)	<p>The computer is warming up before start up. Wait for the computer to start up (takes up to 30 minutes). If "Cannot warm up the system" is displayed, the computer failed to warm up and does not start. In this case, turn off the computer, leave it in an environment of 5 °C {41 °F} or higher temperature for about an hour, and then turn on the power once more.</p>
Remove disks or other media. Press any key to restart	<ul style="list-style-type: none"> If a device is connected to the USB port, disconnect the device, or set [USB Port and Port Replicator] or [Legacy USB Support] to [Disabled] in the [Advanced] menu of the Setup Utility. If the problem persists after removing the disk, it may be a flash memory failure. Contact Panasonic Technical Support.
Reboot and Select proper Boot device or Insert Boot Media in selected Boot device and press a key	<p>The operating system is not properly installed in the flash memory that you are going to boot from.</p> <ul style="list-style-type: none"> If you cannot start up the OS from the internal disk, check if the internal disk is properly recognized on the "Information" menu of the Setup Utility. If it is recognized ("xxx GB" is displayed.), perform the reinstallation. If not ("Empty" is displayed.), contact Panasonic Technical Support. If a device is connected to the USB port, disconnect the device, or set [Legacy USB Support] to [Disabled] in the [Advanced] menu of the Setup Utility.
Disk error Press any key to restart	
Please use the recommended AC adaptor	<ul style="list-style-type: none"> Use the specified AC adaptor.

Network Connections and Communications Software



Close the communications software before using the power saving function.

- If the power saving function (sleep or hibernation) is activated while communications software is used, the network connection may be interrupted, or the performance may be adversely affected. In this case, restart the computer.
- In a network environment, set [Never] for [Sleep after] and [Hibernate after] ( [Setting Sleep or Hibernation](#)).

About Fast startup

The fast startup is enabled as the factory default.



If the computer shut down by the following steps, the fast startup will be disabled at next boot-up.

1. Click  (Start) -  (Settings) - [Update & Security] - [Recovery].
2. Click [Restart now] under "Advanced startup"^{*1}.
3. Click [Turn off your PC].

^{*1} : Screen messages are explained in [English (United States)].

(Depending on the language preference, some screen messages in these instructions are different from the actual screen messages. For example, [Advanced start-up] may be displayed instead of [Advanced startup] in some language preference.)

If you perform the following steps, the fast startup function becomes always disabled.

1. Click  (Start) -  (Settings) - [System] - [Power & sleep] - [Additional power settings] - [Choose what the power buttons do].
2. Click [Change settings that are currently unavailable].
3. Remove checkmark from [Turn on fast startup (recommended)] in "Shutdown settings".

Erasing Flash Memory Data

When disposing the computer or transferring the ownership, erase all flash memory drive data in order to avoid data leakage. Even if you erase the data or initialize the flash memory drive using normal Windows commands, the data can be read with some special software. Use the flash memory drive data erase function to erase the data completely.

Note that transferring of the ownership without uninstalling the commercial software will be a violation of the software's license agreement.

Erasing Flash Memory Data

The flash memory drive data erase function erases data using an overwriting method, but there is a possibility that due to malfunctions or other operational errors, data may not be completely erased. There are also specialized devices that may be able to read data that has been erased using this method. If you need to erase highly confidential data, we recommend that you contact a company that specializes in this process. Panasonic Corporation will bear no responsibility for losses or damages suffered as a result of the use of this function.

IMPORTANT

- **Connect the AC adaptor and do not remove it until flash memory data erase is complete.**

NOTE



- **<Only for model with optical disc drive>**
Even if flash memory drive data erase is performed, the number of times of DVD's region code setting will not be reset.
- **This function cannot be used to erase the data on the specified partition. However, the entire flash memory drive data including the data of the partition with recovery tools will be erased.**
- **The erasing disk menu is not displayed when using the recovery partition.**

Using Recovery Disc

Preparation

- Prepare the following items:
 - <Only for model without optical disc drive> Commercially available optical drive
 - Recovery Disc ( [Create a Recovery Disc](#))
- Remove all peripherals. (except for the commercially available optical drive)
- Connect the AC adaptor and do not remove it until flash memory drive data erase is complete.

1. Start the Setup Utility.

1. Click  (Start) -  (Settings) - [Update & Security] - [Recovery].
2. Click [Restart now] under "Advanced startup".
3. Click [Troubleshoot] - [Advanced options] - [UEFI Firmware Settings] - [Restart].

2. Write down all of the contents of the Setup Utility and press << F9 >> .

At the confirmation message, select [Yes] and press << Enter >> .

3. Insert the media that was used to create the recovery disc.

- For DVD/BD media
 1. Connect the commercially available optical drive to the USB Port (only for model without optical disc drive).
 2. Set a disc into the optical disc drive or the commercially available optical drive.
- For USB storage devices
 1. Connect the USB storage device used to create the recovery disc to the USB port.

4. Press << F10 >> .

At the confirmation message, select [Yes] and press << Enter >> .

The computer will restart.

5. **Press «F2» or «Del» while “Panasonic” boot screen is displayed.**

The Setup Utility starts up.

- If the password is requested, enter the Supervisor Password.

6. **Select the [Exit] menu, and then select optical disc drive, commercially available optical drive or USB storage device in [Boot Override] and press «Enter» .**

The computer will restart.

7. **Click [Erase].**

8. **Click [Erase the all data on the whole Disk.].**

9. **Click [Start Erase Process.].**

Erasing the flash memory drive data starts.

10. **After the erasing is completed, remove the Recovery Disc and click [Shutdown.].**

Specifications

This page provides the specifications for the basic model.

The model number is different according to the unit configuration.

To check the model number:



Check the bottom of the computer or the box the computer came in at the time of purchase.

To check CPU speed, memory size and the flash memory drive (SSD) size:

Run the Setup Utility ( [Setup Utility](#)) and select "Information" menu.

[Processor Speed]: CPU speed, [Memory Size]: Memory size, [Hard Disk]: SSD size

Main Specifications

CPU	Intel® Core™ i5-8365U vPro™ Processor (6 MB*1 cache, 1.6 GHz up to 4.1 GHz with Intel® Turbo Boost Technology) / Intel® Core™ i7-8665U vPro™ Processor (8 MB*1 cache, 1.9 GHz up to 4.8 GHz with Intel® Turbo Boost Technology)		
Chip Set	Built-in CPU		
Video controller	Intel® UHD Graphics 620 (Built-in CPU)		
Main Memory*1*2	8 GB / 16GB, DDR4 SDRAM (32 GB Max.)		
Storage*3	256 GB / 512 GB / 1 TB / OPAL 256 GB / OPAL 512 GB / OPAL 1 TB (SSD) Approx. <For localized OS model> 16 GB*4 / <For MUI OS model> 20 GB*4 is used as a partition with disk recovery tools. (Users cannot use this partition.) Approx. 1 GB is used as a partition with system tools. (Users cannot use this partition.)		
Display Method		14.0" HD (1366 × 768), Aspect ratio 16:9	14.0" FHD (1920 × 1080), Aspect ratio 16:9
	Internal LCD*5	65,536 / 16,777,216 colors (1366 × 768)	65,536 / 16,777,216 colors (1920 × 1080)
	External Display (HDMI)*6	65,536 / 16,777,216 colors (4096 × 2160 Max.)	
Wireless LAN*7	Intel® Wireless-AC 9560 ( Wireless LAN)		
Bluetooth*7*8	( Bluetooth)		
LAN	IEEE 802.3 10Base-T / IEEE 802.3u 100BASE-TX / IEEE 802.3ab 1000BASE-T		
Sound	WAVE and MIDI playback, Intel® High Definition Audio subsystem support, Speaker × 2 (Stereo)		
Security Chip	TPM (TCG V2.0 compliant)		
microSD Memory Card Slot*9	microSDXC, UHS-I		
RAM Module Slot (For extension)	× 1, DDR4 SDRAM, 260-pin, 1.2 V, SO-DIMM, PC4-2400 Compliant		
Interface	USB Ports (USB 3.1 (Type-A) port × 2 / 3.1 (Type-C) with alternative DP (USB Power Delivery*10) × 1)*11 / LAN Port (RJ-45) × 1 / HDMI Port (Type A)*12 / 3.5 mm Headset jack, Stereo Headphone: 4 mW/ch (32 Ω, 1 kHz), CTIA Monaural Microphone / Expansion Bus Connector (Dedicated 24-pin female)		

Keyboard / Pointing Device		82 keys / Touchpad	82 keys / Touchpad <Only for model with touchscreen> 82 keys / Touchpad / Touchscreen: 10 Finger touch (Capacitive) / Φ 2 Passive Stylus
Power Supply		AC adaptor or Battery pack	
AC Adaptor *13		Input: 100 V - 240 V AC, 50 Hz/60 Hz, Output: 15.6 V DC, 7.05 A	
Battery Pack (Main Battery)		Li-ion 10.8 V, 6300 mAh (min.)	
		Operating Time *14	Approx. 20 hours
		Charging Time *15	<Power Off> Approx. 3 hours <Power On> Approx. 3 hours
Power Consumption *16		Approx. 65 W *17 / Approx. 110 W (maximum when recharging in the ON state)	
Physical Dimensions (W × D × H) *18		345 mm × 272 mm × 32.8 mm {13.6" × 10.7" × 1.3"} (without protruding parts)	
Weight *18		Approx. 2.08 kg {Approx. 4.6 lbs.}	<Only for model without touchscreen> Approx. 2.13 kg {Approx. 4.7 lbs.} <Only for model with touchscreen> Approx. 2.22 kg {Approx. 4.9 lbs.}
Environment	Operating Temperature	- 10 °C to 50 °C {14 °F to 122 °F} (IEC60068-2-1, 2) *19*20	
	Operating Humidity	30 % to 80 % RH (No condensation)	
	Storage Temperature	- 20 °C to 60 °C {-4 °F to 140 °F}	
	Storage Humidity	30 % to 90 % RH (No condensation)	

Software

Operating System *21	Windows 10 Pro 64-bit
Pre-installed Software	<ul style="list-style-type: none"> • PC Information Viewer • Panasonic PC Recovery Disc Creation Utility • Intel® PROSet/Wireless Software *22 • Microsoft Office Trial *23 • Wireless Manager Mobile Edition *24*25 • Emergency notification setting • Panasonic PC Camera Utility *22 • Panasonic PC GPS Viewer *26 • Panasonic PC Manual Selector • Panasonic PC Settings Utility *27 • Panasonic PC Backlit Keyboard Settings Utility *22 • Panasonic PC Day Night Mode Utility *22
	<ul style="list-style-type: none"> • Aptio Setup Utility • PC-Diagnostic Utility • Hard Disk Data Erase Utility *28

Optical Disc Drive	DVD MULTI Drive / Blu-ray Disc Drive Buffer underrun error prevention function: Supported Further information, refer to "Optical Disc Drive"
Smart Card Slot	× 1

Rear Expansion Area ^{*34}

VGA Port	× 1, Mini Dsub D-sub 15
True Serial Port	× 1
USB 3.1 (Type-A) port ^{*11}	× 1
Rugged USB 2.0 port ^{*11}	× 1
2nd LAN	IEEE 802.3 10Base-T / IEEE 802.3u 100BASE-TX / IEEE 802.3ab 1000BASE-T

Front Expansion Area ^{*35}

Smart Card Slot	× 1						
Fingerprint Reader	Image Size : 7.4 × 6 mm, Image Resolution : 363 DPI						
Contactless Smart Card Reader (HF band)	× 1, RF frequency: 13.56 MHz, compatible with ISO14443 Type-A, ISO14443 Type-B						
Battery Pack (Second Battery)	Li-ion 10.8 V, 6300 mAh (min.)						
	<table border="1"> <tr> <td>Operating Time^{*14}</td> <td>Approx. 40 hours (with Main Battery + Second Battery)</td> <td>Approx. 38 hours (with Main Battery + Second Battery)</td> </tr> <tr> <td>Charging Time^{*15}</td> <td colspan="2"><Power Off> Approx. 6 hours (with Main Battery + Second Battery) <Power On> Approx. 6 hours (with Main Battery + Second Battery)</td> </tr> </table>	Operating Time ^{*14}	Approx. 40 hours (with Main Battery + Second Battery)	Approx. 38 hours (with Main Battery + Second Battery)	Charging Time ^{*15}	<Power Off> Approx. 6 hours (with Main Battery + Second Battery) <Power On> Approx. 6 hours (with Main Battery + Second Battery)	
Operating Time ^{*14}	Approx. 40 hours (with Main Battery + Second Battery)	Approx. 38 hours (with Main Battery + Second Battery)					
Charging Time ^{*15}	<Power Off> Approx. 6 hours (with Main Battery + Second Battery) <Power On> Approx. 6 hours (with Main Battery + Second Battery)						

*1: 1 MB = 1,048,576 bytes / 1 GB = 1,073,741,824 bytes

*2: Memory size of the factory default depends on the model.

*3: 1 MB = 1,000,000 bytes / 1 GB = 1,000,000,000 bytes / 1 TB = 1,000,000,000,000 bytes. Your operating system or some application software will report as fewer GB.

*4: Space used may increase when system update is performed.

*5: A 16,777,216 color display is achieved by using the dithering function.

*6: Selectable resolution depends on the specifications of the external display. Display may be impossible using some connected external displays.

*7: Only for model with wireless LAN.

*8: Does not guarantee operation of all Bluetooth peripherals.

*9: Operation has been tested and confirmed using Panasonic microSD/microSDHC/microSDXC Memory Cards with a capacity of up to 64 GB. Operation on other microSD equipment is not guaranteed.

*10: Only for model that supports power delivery.

*11: Does not guarantee operation of all USB-compatible peripherals.

*12: Does not guarantee operation of all HDMI-compatible peripherals.

*13: <Only for North America>

The AC adaptor is compatible with power sources up to 240 V AC adaptor. This computer is supplied with a 125 V AC compatible AC cord.

*14: Measured by MobileMark[®] 2014.

Varies depending on the usage conditions, or when an optional device is attached.

MobileMark[®] is a U.S. Registered Trademark of the Business Applications Performance Corporation.

*15: Varies depending on the usage conditions, CPU speed, etc.

- *16: Approx. 0.3 W when the battery pack is fully charged (or not being charged) and the computer is off.
Even when the AC adaptor is not connected to the computer, power is consumed (Max. 0.15 W) simply by having the AC adaptor plugged into an AC outlet.
- *17: Rated power consumption.
- *18: Average value. May differ depending on models and options.
- *19: Do not expose the skin to this product when using the product in a hot or cold environment. ( *OPERATING INSTRUCTIONS - Read Me First*)
When using in hot or cold environment, some peripherals may fail to work properly. Check the operation environment of the peripherals.
Using this product continuously in a hot environment will shorten the product life. Avoid use in these types of environments. When using in low temperature environment, startup may become slow or battery operation time may become short.
The computer consumes power when the SSD is warming up during startup. Therefore, if you are using battery power and the remaining power is low, the computer may not start up.
- *20: <Only for North America>
UL60950 - 1 Evaluated for use at ambient temperatures up to 35 °C {95 °F} when used with optional AC Power Adaptor and 40 °C {104 °F} when used without AC power adaptor.
- *21: Operations of this computer are not guaranteed except for the pre-installed OS and the OS which is installed by using the flash memory recovery and the recovery disc.
- *22: Depending on the models, this application software is not installed.
- *23: To continue using this software after the end of the trial, purchase a license by following the on-screen instructions.
- *24: Must be installed before use.
- *25: For localized OS model. For information on Wireless Manager, refer to the "Supplementary Instructions" by the following procedure.

1. Right-click  (Start).
2. Click [Run], input "c:\util\w\prjct\Supplementary Instructions.pdf" then click [OK].

- *26: Only for model with GPS or wireless WAN.
- *27: Panasonic PC Settings Utility includes the following functions: Touch Screen Mode / USB Charge Settings / etc.
- *28: Perform on the recovery disc.
- *29: These are speeds specified in IEEE802.11a+b+g+n+ac standards. Actual speeds may differ.
- *30: Available when set to "WPA-PSK", "WPA2-PSK" or "none".
Only available when HT40 enabled by the computer and access point which associated supports HT40.
- *31: The specifications may differ depending on the model.
A nanoSIM card (8.8 mm {0.35"} × 12.3 mm {0.48"}) must be inserted in the nanoSIM card slot.



- *32: Option for TOUGHBOOK Universal Bay. For TOUGHBOOK Universal Bay, exclusively configurable by selecting one from Discreted GPU, Optical Disc Drive, 2nd SSD or Smart Card Reader.
- *33: Only for North America / Europe.
- *34: Option for Rear Expansion Area. This option includes VGA port and True Serial port. For Rear Expansion Area, exclusively configurable by selecting one from USB 3.1 Port, 2nd LAN or Rugged USB 2.0 Port.
- *35: Option for Front Expansion Area. For Front Expansion Area, exclusively configurable by selecting one from Smart Card Reader, Fingerprint Reader, Contactless Smart Card Reader or Second Battery.

For Europe

For CE marking, refer to the followings:

Declaration of Conformity (DoC)

“Hereby, Panasonic declares that this computer is in compliance with the essential requirements and other relevant provisions of the Directive 2014/53/EU.”

Hint:

If you want to get a copy of the original DoC of our above mentioned products, please contact our web address: <https://www.ptc.panasonic.eu>

Authorised Representative:

Panasonic Testing Centre

Panasonic Marketing Europe GmbH

Winsbergring 15, 22525 Hamburg, Germany

<Only for model with wireless WAN>

Following are applied for FZ-55A/B/C series with EM7455.

Type of wireless	Communication Mode	Frequency band	Maximum transmit power
WWAN	W-CDMA	1920 - 1980 MHz (Band 1)	24 dBm
	W-CDMA	1710 - 1785 MHz (Band 3)	24 dBm
	W-CDMA	880 - 915 MHz (Band 8)	24 dBm
	LTE	1920 - 1980 MHz (Band 1)	24 dBm
	LTE	1710 - 1785 MHz (Band 3)	24 dBm
	LTE	2500 - 2570 MHz (Band 7)	23 dBm
	LTE	880 - 915 MHz (Band 8)	24 dBm
	LTE	832 - 862 MHz (Band 20)	24 dBm

WARRANTY

For U.S.A.

Panasonic System Solutions Company of North America (PSSNA)

Computer Products - Worldwide Warranties

Section 1: Limited Warranty - Hardware

PSSNA, referred to hereinafter as "Panasonic", will repair the computer products listed below ("Product(s)") with new or rebuilt parts, free of charge in a Global Panasonic designated service location or Panasonic Authorized Service Center for the period specified below from the date of original purchase in the event of a defect in materials or workmanship. These warranties are extended solely to the original purchaser. A purchase receipt or other proof of date of original purchase will be required before warranty performance is rendered.

Original Battery Warranty

Batteries supplied with the product are covered under the warranty for one (1) year from date of purchase. Batteries purchased separately are covered under the warranty for one (1) year from the date of purchase. A replacement battery furnished under the product warranty is covered for the remaining period of the one-year warranty on the original or purchased battery.

Optional: Extended Warranty Program (PC)

If this coverage is purchased, the serial numbered Product is entitled to the same manufacturer's warranty coverage on the Product with the exception of the battery. The cost of labor, parts, and shipping are included in the price of the Extended Warranty Program.

Optional: Panasonic "Protection Plus" Warranty

Any Product for which the Panasonic "Protection Plus" warranty has been purchased will receive additional coverage for any failure that occurs due to accidental damage. All other terms and conditions of the standard warranty apply and this additional coverage will exist for the duration of the standard warranty period of the Product. If an extended Protection Plus warranty program is purchased, coverage is extended to the end of the last year of extended coverage purchased.

This warranty does not cover failures or defects that are caused by fire, intentional acts, loss, theft, improper maintenance, modification or service by anyone other than a Panasonic Authorized Service Provider, or damage that is attributable to acts of God. Cosmetic damage that does not affect functionality is not covered. Cosmetic damage on Products with hardware failures will be repaired in accordance with the warranty terms. This warranty is extended solely to the original purchaser on the Product's serial number for which it was purchased. Complete Product unit replacement fulfills the full obligation and is at the discretion of Panasonic and is limited to once during the coverage term. Refer to the Panasonic website for full terms and conditions on the above programs.

- Additional exclusions apply - please refer to limited warranty exclusions section below.

Optional: Panasonic "Ultimate Care" Warranty

Any Product for which the Panasonic "Ultimate Care" warranty program has been purchased will receive additional coverage as specified in that program, for any failure that occurs due to accidental damage. All other terms and conditions of the standard warranty will apply and this additional warranty coverage will exist for the duration of the standard warranty period of the applicable Product. If an extended warranty is purchased for the Product together with the Ultimate Care warranty program coverage, the warranty term will be extended to the end of the last year of the purchased extended warranty coverage.

The Ultimate Care warranty will cover any hardware failures occurring due to accidental damage of the Product with an exclusion only of customer intentional acts and damage caused by events beyond human control, for up to a maximum of 1% of the total of Products deployed for a specific customer.

This includes unlimited replacement of major sub-assemblies and components of the Product during the standard warranty term and any extended warranty term plan that has been purchased by the customer. This also includes cosmetic damages that may result from exposure of the internal components of the Product to the environmental conditions.

- Additional exclusions apply - please refer to limited warranty exclusions section below.

Wireless Module Warranty

Panasonic approved wireless modems installed in Panasonic brand computers and integrated by Panasonic or an Authorized Panasonic Wireless Integrator are covered under the warranty for the remaining warranty period of the device in which the modem is installed. For devices with less than three (3) months remaining on the unit warranty, the wireless modem will be covered for a period of three (3) months from the date of installation of the modem, covering only modem replacement or modem installation related issues.

All modems must be approved by the wireless carrier prior to use. Any use or attempted use of a wireless modem not approved and activated by the carrier for use on their network is strictly prohibited and is not sanctioned or warranted by Panasonic and may result in legal action. In addition, all modems must be approved by Panasonic as compatible with the device hardware before installation or use.

Panasonic's sole responsibility for the warranty or technical support of the software required to install or operate the modem is defined in Section 2 (Limited Software Warranty). Any attempted software installation by anyone other than a Panasonic Authorized Wireless Integrator is not covered under warranty and may result in service charges.

Installation or attempted installation by any party other than Panasonic or an Authorized Panasonic Wireless Integrator is strictly not covered under the warranty and may void the computer warranty if damage results.

Options and Accessories Warranties

The below listed Panasonic brand or supplied options and accessories are covered under this limited warranty for the period specified from the date of purchase or as specifically stated:

- AC Adaptor / Power Cord - 3 Years
- Memory Expansion Card (Panasonic Brand) - 3 Years
- Car Mount - Docking Station PCB or Vehicle Docking Station - 3 Years
- Desktop Port Replicator, I-O Box, Docking Cradle (like CF-U1) - 3 Years
- Antenna Pass-through Cable - 3 Years
- Backlit or Full-sized keyboard - 3 Years or assumes warranty of the unit in which it is installed
- Integrated Panasonic supplied options and kits including, but not limited to Wireless Modems, Media Bay Drives (CD, DVD, Combo), Camera, GPS, Bluetooth, Smartcard Reader, Magnetic Card Reader, Barcode Reader, and Fingerprint Reader - 3 Years or assumes warranty period of the unit in which it is installed provided the integration was performed by Panasonic or an Authorized Integrator.
- Hard Drive / Solid State Drive (Internal) - 3 Years
- Separately purchased 2nd Hard Drive - 1 Year
- External USB Drives (CD / DVD / Hard Drive) - 1 Year
- Optional Battery - 1 Year
- Battery Charger / Multi-Bay Battery Charger - 1 Year
- Stylus Pens, Digitizer & Standard - 90 Days (physical damage excluded)

Section 2 - Limited Warranty - Software

Panasonic warrants to you only that the disk(s) or other media on which the Programs are furnished will be free from defects in material and workmanship under normal use for a period of sixty (60) days from the date of delivery thereof to you, as evidenced by your purchase receipt.

This is the only warranty Panasonic makes to you. Panasonic does not warrant that the functions contained in the Programs will meet your requirements or that the operation of the Programs will be uninterrupted or error free. Panasonic shall have no obligation for any defects in the disk(s) or other media on which the Programs are furnished resulting from your storage thereof, or for defects that have been caused by operation of the disk(s) or other media.

Panasonic's entire liability and your exclusive remedy under this warranty shall be limited to the replacement, in the United States or other Panasonic designated location, of any defective disk or other media which is returned to Panasonic's Authorized Service Center, together with a copy of the purchase receipt, within the aforesaid warranty period.

Section 3 - Limited Warranty Exclusions - Specifically excluded from the warranty are:

- All consumable items; such as screen protection films, logo badges, labels, cleaning cloths, carry cases, manuals, cables, straps, belts, holsters, tethers, and harnesses and any other options and accessories not listed above or covered under a separate warranty
- The Warranty excludes 3 or less faulty pixels on the LCD screen
- Failures related to the product operating system, hard drive or solid state drive image, software setup, software program, virus, other program (s) or file(s) on any drive or in any computer memory location
- Failures due to BIOS settings or changes, as well as any cosmetic or physical damage to the unit
- Any unit or device with a missing or altered model number or serial number label
- Cosmetic damage or any damage which occurs in shipment
- Failures which are caused by products not supplied by Panasonic
- Failures which result from alteration, accident, misuse, introduction of liquid or other foreign matter into the unit, abuse, neglect, installation, maladjustment of consumer controls, improper maintenance or modification, use not in accordance with product use instructions
- Failures due to service by anyone other than a Panasonic Authorized Service Provider
- Failures caused by improper installation of options or accessories or due to integration by any company other than Panasonic or a Panasonic Authorized Service Center

- Damage, failure, or loss due to the unit being stolen, lost, misplaced, or used by anyone other than the original purchaser
- Damage that is attributable to acts of God
- * Protection Plus and Ultimate Care warranty programs provide protection against accidental damage. Neither program is intended to provide product refurbishment due to normal wear and tear through normal use.
- * Customers who have twenty (20) or more units requiring service are required to contact Panasonic at 800-527-8675 and request Field Engineering assistance to coordinate higher volume repairs.

This limited warranty only covers failures due to defects in materials or workmanship which occur during normal use. If a unit is sent to a Panasonic Authorized Service Center and no hardware failure is found, the customer will be billed for labor to correct a software issue or reimage the applicable Hard Disk, or Solid State Drive plus shipping and applicable administrative fees at the current rates set by the service provider.

While we anticipate use of our products in certain environments such as nuclear equipment/systems, air traffic control equipment/systems, or aircraft equipment/systems (as defined in *1), medical devices or accessories (as defined in *2), medical treatment diagnosis image display, life-support system, or other equipment/devices/systems that are involved with ensuring human life or safety, we do not allow users to integrate our product such that it becomes an integral part of the systems found in these environments.

Panasonic will not be responsible for any liability resulting, and in any way for any damages or loss resulting from the use of this product arising out of the foregoing uses.

*1 : Aircraft equipment/systems include Electric Flight Bag (EFB) systems are defined by FAA AC120-76D or EASA Commission Regulation (EU) No 965/2012.

*2 : As defined by the Regulation (EU) 2017/745 Medical Device Regulation.

Panasonic cannot guarantee any specifications, technologies, reliability, safety (e.g. flammability/smoke/toxicity/radio frequency emission, etc.) requirement related to aviation standards that exceed the specifications of our COTS products.

Other Limits and Exclusions: There are no other express warranties except as listed above.

PANASONIC SHALL NOT BE LIABLE FOR LOSS OF DATA OR OTHER INCIDENTAL OR CONSEQUENTIAL DAMAGES RESULTING FROM THE USE OF THIS PRODUCT, OR ARISING OUT OF ANY BREACH OF THIS WARRANTY. ALL EXPRESS AND IMPLIED WARRANTIES, INCLUDING THE WARRANTIES OF MERCHANTABILITY AND FITNESS FOR A PARTICULAR PURPOSE ARE LIMITED TO THE APPLICABLE WARRANTY PERIOD SET FORTH ABOVE. Some states do not allow the exclusion or limitation of incidental or consequential damages, or limitations on how long an implied warranty lasts, so the above limitations or exclusions may not apply to you.

This limited warranty gives you specific legal rights, and you may also have other rights which vary from state to state.

For technical support or to arrange for service on your Panasonic computer product, call our toll-free hotline at 1-800-LAPTOP5 [option 1] (800-527-8675).

For Canada

PANASONIC COMPUTER AND PERIPHERALS LIMITED WARRANTY

Coverage - Panasonic Canada Inc. ("PCI") warrants to you, the first end user customer, this computer product (excluding software media), when purchased from PCI or from a PCI authorized reseller, to be free from defects in materials and workmanship under normal use, subject to the terms set forth below, during the period of warranty coverage specified.

Scope of Coverage	Period of Coverage	Type of Failure Coverage
<ul style="list-style-type: none"> • Laptop Computers (except Battery) and AC Adaptor • Factory/PCI installed options including Wireless WAN, GPS, Bluetooth, Finger print reader, Backlit keyboard, Memory Card and Media Bay Drives (CD/DVD) • Ultra-Mobile PC • Tablet PC • Mobile Wireless Display • PDRC LCD and Keyboard Assemblies • Port Replicator 	Three (3) Years from Date of Original End User Customer Purchase Defective Materials or Workmanship	Defective Materials or Workmanship

<ul style="list-style-type: none"> • Hand-held Computers • Battery • Battery charger • Auto Adaptor • External USB Drives 	One (1) Year from Date of Original End User Customer Purchase	Defective Materials Workmanship
<ul style="list-style-type: none"> • Standard or Digitizer Stylus Pen 	Ninety (90) Days from Date of Original End User Customer Purchase	Defective Materials or Workmanship
<ul style="list-style-type: none"> • All consumable items including protection film, cleaning cloth, carry case, tether and harness No Coverage 	No Coverage	

Remedy - In the event of a warranty claim, contact PCI's representatives within the applicable warranty period, identifying the nature of the defect claimed, at 1-800-668-8386 between 9:00 A.M. and 5:00 P.M., Eastern Time Zone, Mon. - Fri. (excluding holidays) for instructions on how to obtain service. A purchase receipt or other proof of date of original purchase is required before warranty service is performed. Defective parts covered by this Limited Warranty will be repaired or replaced with new or comparable rebuilt parts on an exchange basis. Warranty replacement or repair is subject to the terms of this Limited Warranty for the balance of the original period of warranty coverage.

No Coverage - This Limited Warranty does not cover products purchased outside Canada. Neither does it cover damage to, failure of, or defects in a product or accessory through mishandling, improper installation, abnormal use, misuse, neglect, accident, introduction of liquid or other foreign matter into the product, alteration or servicing by anyone not authorized by PCI, or act of God.

While we anticipate use of our products in certain environments such as nuclear equipment/systems, air traffic control equipment/systems, or aircraft equipment/systems (as defined in *3), medical devices or accessories (as defined in *4), medical treatment diagnosis image display, life-support system, or other equipment/devices/systems that are involved with ensuring human life or safety, we do not allow users to integrate our product such that it becomes an integral part of the systems found in these environments.

Panasonic will not be responsible for any liability resulting, and in any way for any damages or loss resulting from the use of this product arising out of the foregoing uses.

*3 : Aircraft equipment/systems include Electric Flight Bag (EFB) systems are defined by FAA AC120-76D or EASA Commission Regulation (EU) No 965/2012.

*4 : As defined by the Regulation (EU) 2017/745 Medical Device Regulation.

Panasonic cannot guarantee any specifications, technologies, reliability, safety (e.g. flammability/smoke/toxicity/radio frequency emission, etc.) requirement related to aviation standards that exceed the specifications of our COTS products.

IF YOU SHIP THE PRODUCT FOR WARRANTY SERVICE

Carefully pack the product, preferably in the original carton. Include details of defect claimed and proof of date of original purchase. No liability is assumed for loss or damage to the product while in transit, if you chose your own transportation carrier.

SOFTWARE MEDIA LIMITED WARRANTY

Coverage - PCI warrants to you, the first end user customer, that the disk(s) or other media on which software program(s) is/are supplied will be free from defects in materials and workmanship under normal use in Canada for a period of sixty (60) days from date of receipt as evidenced by your purchase receipt for your Panasonic Computer product.

THIS IS THE ONLY WARRANTY THAT PCI MAKES RESPECTING THE SOFTWARE MEDIA. PCI does not warrant the software. Please refer to the software licensor's written warranty (accompanying the copy of the software) for any software warranty claim.

Claim Procedure - In the event of a defect in material or workmanship in the media during the sixty (60) days warranty period, and you return it, transportation costs prepaid, to Panasonic Canada Inc., Computer Products Marketing, 5770 Ambler Drive, Mississauga, Ontario L4W 2T3, within the warranty period, together with a copy of your purchase receipt, and an explanation of the suspected defect, PCI will replace in Canada the defective disk(s) or other media.

Remedy - PCI's entire liability, and your only remedy for any breach of this software media warranty is limited to replacement of the media only. It does not cover any other damages, including, but not limited to, loss of use or profit loss, or special, indirect or consequential damages, or other claims, whether or not of similar character.

No Coverage - This limited warranty does not apply if the disk(s) or other media has been used in other than a Panasonic product, or in environmental conditions other than those specified by PCI or the manufacturer, or if subjected to misuse, neglect, mishandling, modification or attempted modification of the program, or if damaged by accident or act of God. PCI is not responsible for damage to or loss of any program, data or removable storage media.

GENERAL

NO OTHER WARRANTIES - PCI DISCLAIMS ALL OTHER WARRANTIES, EITHER EXPRESS OR IMPLIED, INCLUDING, BUT NOT LIMITED TO, IMPLIED WARRANTIES OF MERCHANTABILITY AND FITNESS FOR A PARTICULAR PURPOSE, WITH RESPECT TO THE SOFTWARE, SOFTWARE MEDIA, COMPUTER PRODUCT, OPTIONS AND ACCESSORIES.

NO LIABILITY FOR CONSEQUENTIAL DAMAGES - IN NO EVENT SHALL PCI BE LIABLE FOR ANY SPECIAL, INDIRECT OR CONSEQUENTIAL DAMAGES ARISING FROM ANY BREACH OF THE LIMITED WARRANTIES SET OUT IN THIS DOCUMENT, OR FROM THE USE OF THE COMPUTER PRODUCT, INCLUDING, WITHOUT LIMITATION, LOSS OF DATA, BUSINESS, PROFIT OR GOODWILL. IN ANY EVENT, PCI'S

MAXIMUM LIABILITY FOR ANY BREACH SHALL NOT EXCEED THE AMOUNT ACTUALLY PAID BY YOU FOR THE COMPUTER PRODUCT. NO ACTION, REGARDLESS OF ITS BASIS, MAY BE BEGUN AGAINST PCI MORE THAN TWO (2) YEARS AFTER THE CAUSE OF ACTION AROSE.

Statutory Warranties - Some jurisdictions do not allow these limitations or exclusions, so they may not apply to you.

Pour le Canada

GARANTIE LIMITÉE - ORDINATEURS ET PÉRIPHÉRIQUES PANASONIC

Couverture - Panasonic Canada Inc. (« PCI ») garantit à l'acheteur original que ce produit informatique (à l'exclusion des supports des logiciels) est, au moment de sa vente par PCI ou d'un revendeur agréé par PCI, exempt de défauts de pièces et de fabrication dans les conditions normales d'utilisation, et ce, pendant la période de couverture de la garantie, sous réserve des modalités décrites ci-dessous.

Éléments couverts	Durée de couverture	Type de couverture
<ul style="list-style-type: none">• Ordinateurs blocs-notes (sauf batteries) et adaptateur secteur• Options installées en usine/par PCI incluant : WAN sans fil, GPS, Bluetooth, lecteur d'empreintes digitales, clavier rétroéclairé, carte mémoire et lecteurs (CD/DVD)• Ordinateurs personnels ultra-portables• Ordinateurs tablettes• Écran mobile sans fil• Ensembles PDRC - ACL et clavier• Duplicateur de port	Trois (3) ans à partir de la date d'achat original.	Défauts de pièces et de fabrication
<ul style="list-style-type: none">• Ordinateurs de poche• Batterie• Chargeur de batterie• Adaptateur pour voiture• Périphériques USB	Un (1) an à partir de la date d'achat original.	Défauts de pièces et de fabrication
<ul style="list-style-type: none">• Stylo pointeur standard ou pour numériseur graphique	Quatre-vingt-dix (90) jours à partir de la date d'achat original.	Défauts de pièces et de fabrication
<ul style="list-style-type: none">• Tous les articles consommables incluant les pellicules protectrices, chiffons de nettoyage, étuis de transport, longes et sangles	Aucune couverture	

Recours - Pour obtenir des informations sur la marche à suivre dans le cas où une réclamation en vertu de la garantie deviendrait nécessaire, communiquez par téléphone avec un représentant de PCI au 1-800-668-8386, entre 9h00 et 17h00 (heure de l'Est) du lundi au vendredi (sauf les jours fériés), avant l'échéance de la garantie applicable, en prenant soin d'identifier la nature de la défaillance.

Un reçu ou toute autre pièce justificative de la date d'achat original sera exigé avant toute réparation. Toute pièce défectueuse couverte par la présente garantie limitée sera réparée ou remplacée par une pièce neuve ou remise à neuf. Le remplacement ou la réparation sera fait conformément aux modalités de la présente garantie limitée pendant la durée restante de la période originale de la garantie.

Produits non couverts - La présente garantie limitée ne couvre pas les produits achetés à l'extérieur du Canada. Elle ne couvre pas non plus les dommages, la défaillance ou les défauts attribuables à une maintenance inadéquate, une mauvaise installation, une utilisation anormale ou abusive, de la négligence, un accident, un déversement ou la pénétration d'un objet étranger, une modification, un cas fortuit ou une réparation effectuée par une personne non agréée par PCI.

Bien que nous anticipions l'utilisation de nos produits dans certains environnements tels que les systèmes/équipements nucléaires, systèmes/équipements de contrôle du trafic aérien ou systèmes/équipements d'avions (comme défini dans ^{*5}), dispositifs ou accessoires médicaux (comme défini dans ^{*6}), affichages d'images de diagnostic pour traitement médical, systèmes d'assistance de vie artificielle ou tout autre équipement/dispositif/système lié à la vie ou la sécurité humaine, nous n'autorisons pas les utilisateurs à intégrer nos produits de telle sorte qu'ils fassent partie intégrante des systèmes trouvés dans ces environnements.

Panasonic n'acceptera aucune responsabilité pour tout incident, et d'aucunes façons pour tout dommages ou pertes résultant de l'usage de ce produit pour l'une des fonctions énoncées ci-dessus.

*5 : Les systèmes/équipements d'avion incluent les systèmes à Sac de vol électronique (EFB) sont définis par l'AA AC120-76D ou le Règlement de la Commission de l'AESA (UE) N° 965/2012.

*6 : Comme prescrit par le Règlement (UE) 2017/745 concernant les dispositifs médicaux.

Panasonic ne donne aucune garantie en ce qui concerne les spécifications, les technologies, la fiabilité et la sécurité (par exemple, l'inflammabilité, la fumée, la toxicité, l'émission de fréquences radio, etc.) relatives aux normes de l'aviation qui ont dépassé les spécifications de nos produits produits COTS.

EXPÉDITION DU PRODUIT POUR SERVICE SOUS GARANTIE

Emballer soigneusement le produit, de préférence dans son emballage d'origine. Joignez une description de la défaillance de même qu'une pièce justificative de la date d'achat. Panasonic Canada Inc. ne peut être tenue responsable pour tout dommage ou perte subi pendant le transport si vous avez choisi le transporteur.

GARANTIE LIMITÉE - SUPPORTS DES LOGICIELS

Couverture - Panasonic Canada Inc. (« PCI ») garantit à l'acheteur original que la ou les disquettes ou tout autre support sur lequel le ou les programmes sont fournis sont exempts de défauts de pièces et de fabrication dans des conditions normales d'utilisation au Canada, et ce, pour une période de soixante (60) jours suivant la date de réception indiquée sur la preuve d'achat.

LA PRÉSENTE GARANTIE EST LA SEULE OFFERTE PAR PCI COUVRANT LES SUPPORTS DE LOGICIELS. PCI ne garantit pas les logiciels. Reportez-vous à la garantie écrite du concédant de licence d'utilisation du logiciel (qui accompagne la copie du logiciel) pour toute réclamation en vertu de la garantie.

Réclamation - marche à suivre - Panasonic Canada Inc. remplacera toute disquette ou support défectueux si l'article en question est retourné, port payé, à son service de Marketing - produits informatiques, 5770 Ambler Drive, Mississauga (Ontario) L4W 2T3, dans les soixante (60) jours suivant la date d'achat original. Joignez à votre envoi une pièce justificative de votre achat et une description du problème.

Recours - La responsabilité de PCI - et votre seul recours - dans le cas de toute défaillance couverte par la garantie sur ce support de logiciel est limitée au seul remplacement du support. Elle ne couvre aucun autre dommage, y compris, mais non exclusivement, la perte d'usage ou de profits, ni aucun dommage spécial, indirect ou consécutif, ni aucune autre réclamation de nature similaire ou autre.

Produits non couverts - La présente garantie limitée ne s'applique pas si la ou les disquettes ou autre support ont été utilisés dans un produit d'une marque autre que Panasonic ou dans des conditions environnementales autres que celles spécifiées par PCI ou le fabricant, ou soumis à une mauvaise utilisation, à la négligence, à une manutention inadéquate ou encore si le programme a été modifié ou subi une tentative de modification ou des dommages attribuables à un accident ou à un cas fortuit. De plus, PCI n'assume aucune responsabilité pour toute perte de, ou tout dommage à, un programme, des données ou un support de sauvegarde amovible.

GÉNÉRALITÉS

PCI NE RECONNAÎT AUCUNE AUTRE GARANTIE, EXPLICITE OU IMPLICITE, Y COMPRIS, MAIS NON EXCLUSIVEMENT, LES GARANTIES IMPLICITES DE VALEUR COMMERCIALE ET D'UTILITÉ À UNE FIN QUELCONQUE, À L'ÉGARD DU LOGICIEL, SUPPORTS DE LOGICIELS, PRODUITS INFORMATIQUES, PÉRIPHÉRIQUES ET ACCESSOIRES.

SOUS AUCUNE CIRCONSTANCE PCI NE POURRA ÊTRE TENUE RESPONSABLE DES DOMMAGES SPÉCIAUX, INDIRECTS OU CONSÉCUTIFS ATTRIBUABLES À UN MANQUEMENT AUX GARANTIES LIMITÉES DÉCRITES DANS LE PRÉSENT DOCUMENT OU À L'UTILISATION DU PRODUIT INFORMATIQUE, Y COMPRIS, SANS RESTRICTION, LA PERTE DE DONNÉES, D'AFFAIRES, D'ACHALANDAGE OU DE PROFIT.

DANS TOUS LES CAS, LA RESPONSABILITÉ MAXIMALE DE PCI POUR TOUT MANQUEMENT NE POURRA EXCÉDER LE PRIX DE VENTE DU PRODUIT INFORMATIQUE. AUCUNE RÉCLAMATION, SANS ÉGARD À SES MOTIFS, NE POURRA ÊTRE FAITE AUPRÈS DE PCI PLUS DE DEUX (2) ANS APRÈS LES FAITS INVOQUÉS À LA BASE D'UNE TELLE RÉCLAMATION.

Garantie statutaires - Certaines juridictions interdisent de telles limitations ou exclusions; aussi, pourraient-elles ne pas s'appliquer.

For Europe

Panasonic System Communications Company Europe

Panasonic System Communications Company Europe (referred to as "Panasonic") will repair this product (other than software, which is treated in a different section of this warranty) with new or refurbished parts, from the date of original purchase in the event of a defect in materials or workmanship.

This warranty only applies to new Panasonic Toughbooks purchased in the EEA and Switzerland and Turkey.

Panasonic (or its authorised Service Provider) target to repair your equipment within 48 hours from its receipt in our service centre.

Additional charges may apply for shipment to countries outside of the European Union. Panasonic will use all reasonable endeavours to ensure this service.

This warranty only covers failures due to defects in materials or workmanship which occur during normal use for the applicable Service Agreement Period listed below. In the event that any product (or part thereof) is replaced, Panasonic shall transfer ownership of the replacement product (or part) to the customer and the customer shall transfer ownership of the replaced product (or part) to Panasonic.

Service Agreement Period - from original date of purchase

- Toughbooks (and every accessory included in the original packaging except the battery) - 3 years
- Toughpads (and every accessory included in the original packaging except the battery) - 3 years
- Accessories included in the original package - 3 years

- Additional peripherals manufactured by Panasonic (including media bay devices such as CD-Rom drives) - 1 year
- Batteries - 6 months. Panasonic Warranty covers the battery for six months. A battery is considered good if it maintains 50% of its charge capacity during the warranty period. If a battery is returned under this contract and testing determines that it has charge capacity greater than 50%, the battery will be returned with an invoice for the retail purchase price of a new battery.

This warranty is extended solely to the original purchaser. A purchase receipt or other proof of date of original purchase will be required before warranty performance is rendered.

Limits and Exclusions:

This warranty does not cover and shall be void for:

- Broken or cracked LCD screen.
- Defective pixel in notebook displays and LCD screens within 0.002%
- Damage that is attributable to fire, theft or acts of God.
- Damage caused by environmental influences (electrical storms, magnetic fields etc.).
- Damage which has not been caused during normal operation
- Repair of damage that is cosmetic only or does not affect product functionality such as wear and tear, scratches and dents.
- Failures caused by products not supplied by Panasonic.
- Failures resulting from alteration, accidental damage, casualty, misuse, abuse or neglect.
- Introduction of liquid or other foreign matter into the unit.
- Improper installation, operation or maintenance.
- Improper connections with peripherals.
- Maladjustment of consumer controls such as function settings.
- Modification or service by anyone other than Panasonic or its approved Service Providers.
- Products used as short term rental or leased equipment.
- Products whose serial number has been removed making the unit warranty condition impossible to clearly determine.

The product is not intended for use as, or as part of nuclear equipment/systems, air traffic control equipment/systems, aircraft equipment/systems (as defined in *7), medical devices or accessories (as defined in *8), medical treatment diagnosis image display, life-support system, or other equipment/devices/systems that are involved with ensuring human life or safety. Our products are not intended to be utilised as an integral component of the systems used in such environments and, as such, the use of our products in such environments is not recommended.

Panasonic can not be held responsible in any way for any damage or loss resulting from the use of this unit in these types of equipment, devices or systems, etc.

*7 : Aircraft equipment/systems include Electric Flight Bag (EFB) systems are defined by FAA AC120-76D or EASA Commission Regulation (EU) No 965/2012.

*8 : As defined by the Regulation (EU) 2017/745 Medical Device Regulation.

Panasonic cannot guarantee any specifications, technologies, reliability, safety (e.g. flammability/smoke/toxicity/radio frequency emission, etc.) requirement related to aviation standards that exceed the specifications of our COTS products.

Panasonic shall not be liable for loss of data or other incidental or consequential damages resulting from the use of this product, or arising out of any breach of this warranty. All express and implied warranties, including the warranties of satisfactory quality and fitness for a particular purpose are limited to the applicable warranty period set forth above. Panasonic shall not be liable for any indirect, special or consequential loss or damage (including without limitation any loss of profits) arising from the use of this product or for any breach of this warranty.

This limited warranty gives you specific legal rights, and you may have other rights that vary from country to country. You must consult the applicable country laws for a full determination of your rights. This limited warranty is in addition to, and does not affect any rights arising out of any contract of sale or by statute.

Data Storage Media

Data Storage Media is the media on which the Operating System, drivers and programs originally installed by Panasonic on the tablet are stored. This media is originally provided with the unit.

Panasonic warrants to you only that the disc(s) or other media on which the Programs are furnished will be free from defects in material and workmanship under normal use for a period of sixty (60) days from the date of delivery thereof to you, as evidenced by your purchase receipt.

This is the only warranty Panasonic makes to you. Panasonic does not warrant that the functions contained in the Programs will meet your requirements or that the operation of the Programs will be uninterrupted or error free.

Panasonic's entire liability and your exclusive remedy under this warranty shall be limited to the replacement of any defective disk or other media which is returned to Panasonic's authorized Service Centre, together with a copy of the purchase receipt, within the aforesaid warranty period.

Panasonic shall have no obligation for any defects in the disk(s) or other media on which the Programs are furnished resulting from your storage thereof, or for defects that have been caused by operation of the disk(s) or other media otherwise than on the Product or in the environment conditions other than those specified by Panasonic by alteration, accident, misuse, abuse, neglect, mishandling, misapplication, installation, maladjustment of consumer con-

trols, improper maintenance, modification or damage that is attributable to acts of God. In addition, Panasonic shall have no obligation for any defects in the disk(s) or other media if you have modified, or attempted to modify any Program.

Duration of implied warranties, if any is limited to sixty (60) days.

Pre-installed software

Pre-installed software means the software shipped pre-loaded by Panasonic, not that loaded by any third party or selling agent.

Panasonic and its suppliers makes no warranty, either express, implied or statutory, with respect to software provided with the Product and licensed to Purchaser, its quality, performance, merchantability, or fitness for a particular purpose. Panasonic does not warrant that the functions contained in the software will be uninterrupted or error free. Panasonic assumes no risk of and shall not in any case be liable for any damages, including, without limitation, any special, incidental, consequential, or punitive damages arising from breach of warranty or contract, negligence or any other legal theory, including, without limitation loss of goodwill, profits or revenue, loss of use of the Programs or Products or any associated equipment, cost of capital, cost of any substitute equipment, facilities, or services, downtime costs, or claims of any party dealing with such damages.

Some countries do not allow the exclusion or limitation of incidental or consequential damages, or limitations on how long an implied warranty lasts, so the above limitations or exclusions may not apply to you.

This limited warranty gives you specific legal rights and you may also have other rights that vary from country to country. You must consult applicable country laws for a full determination of your rights.

Contacts

Address Panasonic System Communications Company Europe
Panasonic Manufacturing U.K. Ltd.
Service Centre Building B4,
Wharfedale Road, Pentwyn Industrial
Estate, Cardiff,
United Kingdom
CF23 7XB

Web page <https://business.panasonic.co.uk/computer-product/>

Help desk

English speaking service	+44 (0) 800 0884324
French speaking service	+33 (0) 80 5636449
German speaking service	+49 (0) 800 7235211
Italian speaking service	+39 800 986915
Spanish speaking service	+34 (0) 901 101 157
Austria	+43 (0) 800 006493
Switzerland (German)	+41 (0) 800 002429
Switzerland (French)	+41 (0) 800 588017
E-mail address	toughbooksupport@eu.panasonic.com

Czech speaking service	+420 (0) 800 143234
Hungarian speaking service	+36 (0) 6800 163 67
Polish speaking service	+48 (0) 800 4911558
Romanian speaking service	+40 (0) 800 894 743
Slovakian speaking service	+421 (0) 800 42672627
E-mail address	toughbooksupport@csg.de

Payments	toughbookservicepayments.cardiff@eu.panasonic.com
----------	---