



Operation Instruction

— Dual Mode (Ballast Dependant or Ballast By Pass)

Product Name: PLS Dual Mode Series

Input Voltage: Determined By Fluorescent Ballast (Ballast Dependent Mode)
120-277VAC 50/60Hz (Ballast By Pass Mode)

Product Models Included:

- S11550 5.5W/LED/CFL/827/2P/DUAL
- S11551 5.5W/LED/CFL/830/2P/DUAL
- S11552 5.5W/LED/CFL/835/2P/DUAL
- S11553 5.5W/LED/CFL/840/2P/DUAL
- S11554 5.5W/LED/CFL/850/2P/DUAL

1. Product Features:

- c UL us classified and c UL us listed
- Two operation models:
 - Ballast Dependent Mode (Type A), compatible with magnetic ballasts.
 - Ballast By Pass Mode (Type B)
Direct connect with the mains: 120-277VAC 50/60Hz (universal voltage input)

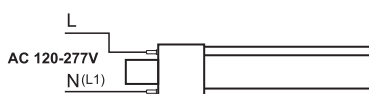

2. Products Applications:

Widely used in residential buildings, offices, shopping malls, supermarkets, hospitals, assembly lines, warehouses, etc. for energy saving illumination.

3. Installation Instructions:

Please completely comply with these instructions and notes, to ensure that the product is operated in a safe condition.

4. Safety Information:

- 1). Check the lamp before installation, if there is any damage caused during transportation, do not install.
- 2). Maintenance should be carried out by technical personnel only.
- 3). Do not stare at the light source with bare eyes for a long time, or beam to others' eyes.
- 4). Do not place any objects on the lamp.
- 5). Keep the lamp away from flame or high temperature objects.
- 6). Only replace with same type of LED lamp! Risk of electric shock!
- 7). If the lamp is broken, the lamp must be disposed of immediately!

5. Maintenance Notes:

- 1). Disconnect lamp from power supply before any maintenance.
- 2). Clean luminaire with dry cloth.
- 3). Do not clean the lamp with corrosive chemicals.

⚠ Safety Precautions :

For your and others' safety, please read the precaution carefully before installation.

For Ballast Dependent Mode (Type A)

- 1). WARNING: Risk of shock. Disconnect power before installation.
- 2). WARNING: Risk of fire, use only in place of fluorescent lamps specified on label. Risk of electric shock. Suitable for damp locations.
- 3). LED lamp for use only with products described and installed in accordance with product specifications. LED lamp to be operated with fluorescent magnetic ballast.
- 4). Not for emergency lighting.

For Ballast By Pass Mode (Type B)

- 1). Product should be installed by qualified electrician.
- 2). Switch off the power supply before commencing work, make sure correct connection before power on.
- 3). Not for emergency lighting.
- 4). The devices are intended to retrofit surface mount Type IC or non-IC recessed mount Listed fluorescent luminaires that use maximum two lamps with or without a diffuser the minimum dimension of luminaires are tabulated below:

Model Number	Max No. of lamp	MINIMUM LAMP COMPARTMENT DIMENSIONS	Lamp-to-lamp Spacing
S11550 5.5W/LED/CFL/827/2P/DUAL S11551 5.5W/LED/CFL/830/2P/DUAL S11552 5.5W/LED/CFL/835/2P/DUAL S11553 5.5W/LED/CFL/840/2P/DUAL S11554 5.5W/LED/CFL/850/2P/DUAL	2	22 cm(L) x 14.5 cm(W) x 11 cm(H)	1cm

Ballast Dependent Mode (Type A)

INSTALLATION INSTRUCTIONS

- 1) Make Sure Power is OFF
- 2) Remove lens or diffuser (if applicable)
- 3) Remove existing fluorescent lamps from the luminaire.
- 4) Bring LED lamp to luminaire and insert lamp pins into luminaire lamp holders.
- 5) Place lens or diffuser back in place (if applicable)
- 6) Power ON

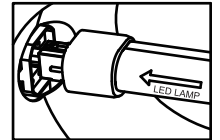
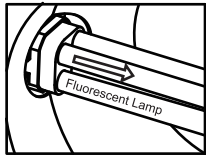

Magnetic Ballast Wiring Diagram

Retrofit luminaire with 1 lamp

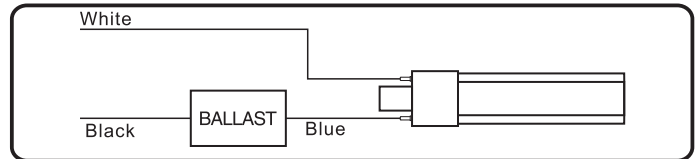
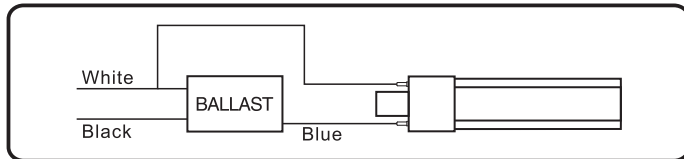

Retrofit luminaire with 2 lamps

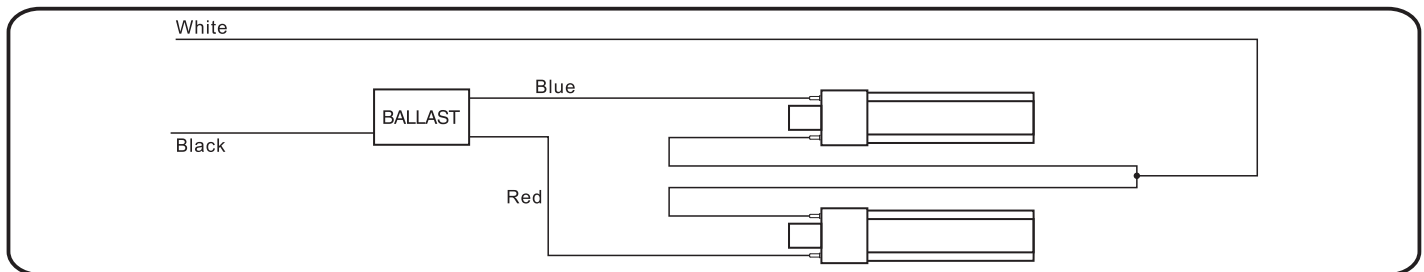

Ballast By Pass Mode (Type B)

Retrofit luminaire with 1 lamp

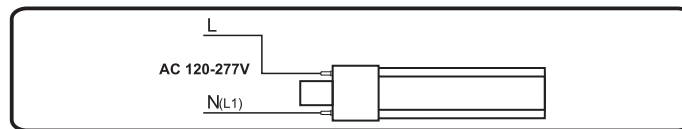
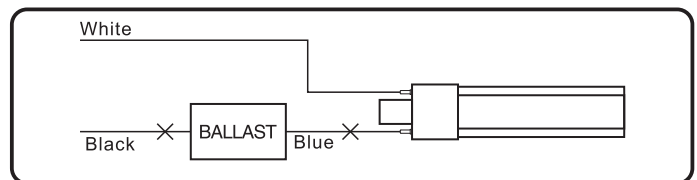
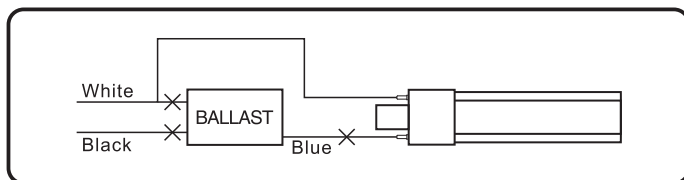

Retrofit luminaire with 2 lamps

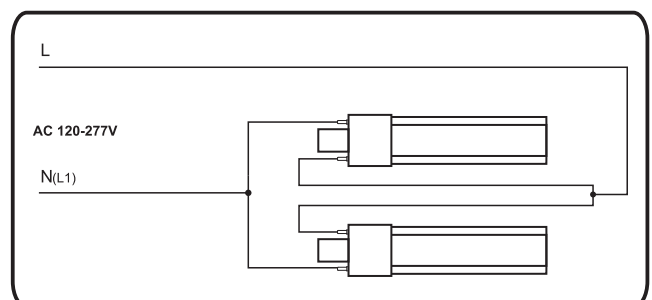
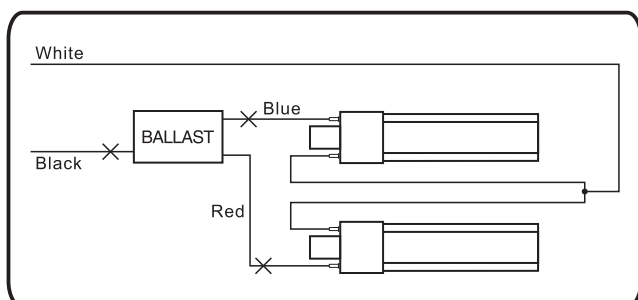

WARNING - Risk of fire or electric shock. LED Retrofit Kit installation requires knowledge of luminaires electrical systems. If not qualified, do not attempt installation. Contact a qualified electrician.

AVERTISSEMENT - Risque d'incendie ou de choc électrique. Installation du kit de Retrofit LED exige une connaissance des systèmes électriques luminaires. Si vous n'êtes pas qualifié, ne tentez pas de l'installation. Contactez un électricien qualifié.

WARNING - Risk of fire or electric shock. Install this kit only in luminaires that have the construction features and dimensions shown in the photographs and/or drawings and where the input rating of the retrofit kit does not exceed the input rating of the luminaire.

AVERTISSEMENT - Risque d'incendie ou de choc électrique. Installez ce kit dans les luminaires qui ont les caractéristiques de construction et les dimensions indiquées dans les photographies et / ou dessins et où la cote d'entrée du kit de modification ne dépasse pas la capacité d'entrée du luminaire.

WARNING -To prevent wiring damage or abrasion, do not expose wiring to edges of sheet metal or other sharp objects.

AVERTISSEMENT - Pour éviter d'endommager le câblage ou à l'abrasion, ne pas exposer le câblage aux bords de tôle ou d'autres objets pointus.

THIS LAMP ONLY OPERATES ON MAGNETIC BALLASTS. IF LAMP DOES NOT LIGHT WHEN THE LUMINAIRE IS ENERGIZED, REMOVE LAMP FROM LUMINAIRE AND CONTACT LAMP MANUFACTURER OR QUALIFIED ELECTRICIAN.

CETTE LAMPE OPERE SEULEMENT AVEC LE BALLAST MEGNETIQUE. SI LA LAMPE NE S'ALLUME PAS QUAND L'APPAREIL D'ECLAIRAGE ACTIVE, ENLEVEZ LA LAMPE DE L'APPAREIL D'ECLAIRAGE ET CONTACTEZ LE FABRICANT DE LAMPE OU UN ELECTRICIEN QUALIFIE.

CAUTION RISK OF FIRE - IF THE LAMP OR LUMINAIRE EXHIBITS UNDESIRABLE OPERATION (BUZZING, FLICKERING, ETC.), IMMEDIATELY TURN OFF POWER, REMOVE LAMP FROM LUMINAIRE AND CONTACT MANUFACTURER.

ATTENTION RISQUE DE FEU - SI LA LAMPE OU LE LUMINAIRE MONTRE DES SIGNES D'OPERATION INDESIRABLE (BRUIT, VIBRATION, CLIGNOTEMENT, ETC.), ALORS COUPER IMMEDIATEMENT LE COURANT ET ENLEVER LA LAMPE DE L'APPAREIL D'ECLAIRAGE ENTRER EN CONTACT AVEC LE FABRICANT.

Do not make or alter any open holes in an enclosure of wiring or electrical components during kit installation.

DO NOT INSTALL THIS LAMP IN A PRE-HEAT LUMINAIRE.

Installers should not disconnect existing wires from lampholder terminals to make new connections at lampholder terminals. Instead installers should cut existing lampholder leads away from the lampholder and make new electrical connections to lampholder lead wires by employing applicable connectors.

THE RETROFIT KIT IS ACCEPTED AS A COMPONENT OF A LUMINAIRE WHERE THE SUITABILITY OF THE COMBINATION SHALL BE DETERMINED BY AUTHORITIES HAVING JURISDICTION. PRODUCT MUST BE INSTALLED BY A QUALIFIED ELECTRICIAN IN ACCORDANCE WITH THE APPLICABLE AND APPROPRIATE ELECTRICAL CODES. THE INSTALLATION GUIDE DOES NOT SUPERSEDE LOCAL OR NATIONAL REGULATIONS FOR ELECTRICAL INSTALLATIONS.

This device complies with Part 15 of the FCC Rules. Operation is subject to the following two conditions:(1)this device may not cause harmful interference, and (2)this device must accept any interference received, including interference that may cause undesired operation.

This product may cause interference to radio equipment and should not be installed near maritime safety communications equipment or other critical navigation or communication equipment operating between 0.45-30 MHz.



Satco Products, Inc
110 Heartland Blvd.Brentwood, NY 11717
www.satco.com