

DLE6

Edge Lit Recessed LED Downlight

Product Description

The DLE Edge Lit LED Downlight Series offers an attractive visual aesthetic with a low profile in both round and square apertures. The edge-lit technology uses a reflective light guide panel that disperses light through a diffused lens, making it a practical and economical solution with high performance. The ultra-thin fixture depth and off-board driver allow for more flexible installation and increased lifetime with improved thermal management. The DLE fixture uses a plenum-rated cable connector to link the downlight module to the remote driver box and then pops into place with its adjustable, spring-loaded retention tabs for a secure fit, eliminating the need for a J-box or recessed housing. Adding light in tight spaces such as hallways, bathrooms, basements, entryways, porches, stairways, work areas, utility closets and corridors just got easier.

Construction

- Cast aluminum housing routes heat away from electrical components
- Edge-Lit technology allows for extremely thin fixture depth
- Adjustable, spring loaded retention tabs ensure secure fixture retention
- Certified for direct contact with insulation
- Includes gasket to meet AirTight requirements
- Square fixture has round back for easier cut in with standard hole cutters.

Optical System

- Precision engineered optical stack creates uniform light distribution that maximizes lumen output
- CCT offered at 2700K, 3000K, 4000K, 5000K
- Utilizes high performing LEDs with a greater than 90 CRI and an R9 greater than 50

Electrical

- Off-board driver minimizes installation height and maximizes fixture life through improved heat management
- Dimmable to less than 5% with compatible TRIAC dimmers
- Operating temperature of 0° to 120°F (-18°C to 49°C)
- Input voltage of 120VAC
- TM-21 Reported L70(9K) hours >54,000

Finish

- White powder coat finish standard
- Color trims available in Black, Nickel and Aged Copper
- Available in round or square configurations

Mounting and Installation

- Spring loaded retention arms allow for easy installation into ceilings up to 1/2" (RD) or 3/8" (SQ) thick with no need for a recessed housing
- Off-board driver/junction box includes two 1/2" KO's and three-port poke-in connectors
- Included paper cutting template
- Metal rough in template available
- Extension power cables (2', 10', 20') available
- Suitable for damp locations

Warranty

- 5-year limited system warranty standard
- Warranty does not cover product failure due to an overvoltage event (power surge)
- For installations where power surge may be possible, NICOR recommends installing additional surge protection at the electrical distribution panel

Project

Catalog

Type

Date

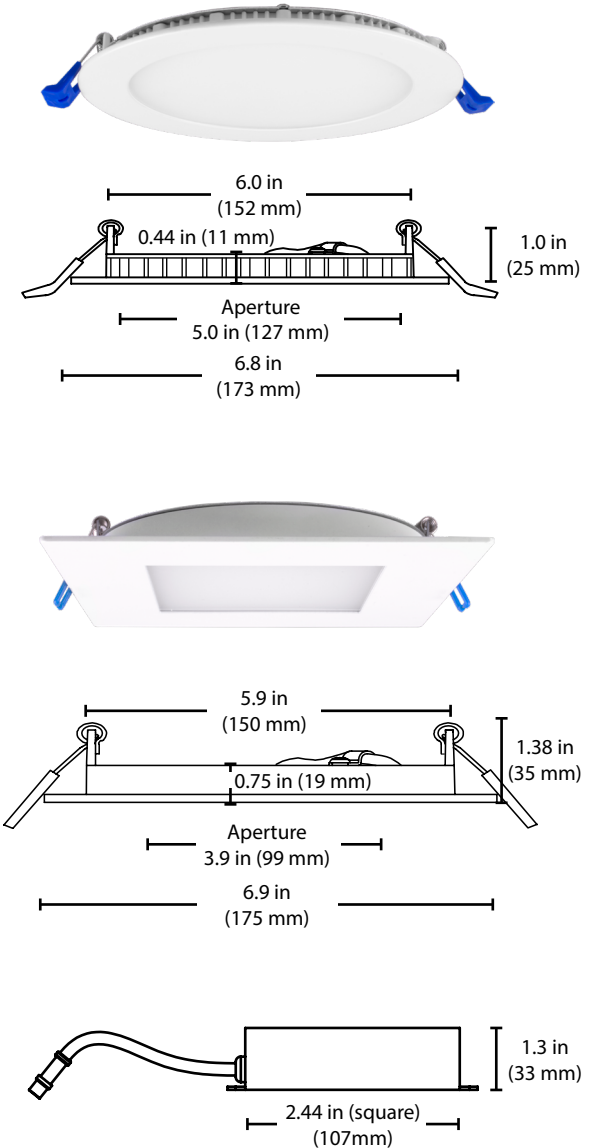

Photometric Data

DLE6 2700K RD

Input Voltage (VAC)	120V
System Level Power (W)	13.9
Delivered Lumens (Lm)	982
System Efficacy (Lm/W)	71
Correlated Color Temp (K)	2726
Color Rendering Index (CRI)	93
Beam Angle	110°
Spacing Criteria	1.25

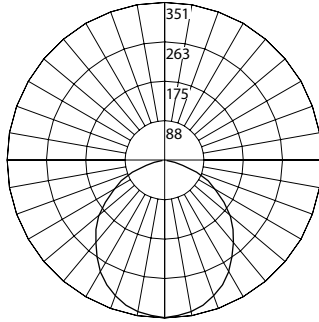

Intensity Summary (Candle Power)

Angle	Mean CP
0	351
5	349
15	336
25	310
35	274
45	228
55	176
65	120
75	64
85	17
90	0

CCT Data Multiplier

DLE621203KRD	1.024
DLE621204KRD	1.044
DLE621205KRD	1.071

Cone of Light Tabulation

Mounted height (Feet)	Footcandles Beam Center	Diameter (Feet)
4	21.9	11.5
6	9.7	17.2
8	5.5	22.9
10	3.5	28.6
12	2.4	34.4
14	1.8	40.1
16	1.4	45.8

Zonal Lumen Summary

Zone	Lumens	% of Luminaire
0-30	271	27.6%
0-40	442	45%
0-60	776	78.9%
0-90	981	99.9%
90-180	1	0.1%
0-180	982	100%

DLE6 2700K SQ

Input Voltage (VAC)	120V
System Level Power (W)	10.8
Delivered Lumens (Lm)	858
System Efficacy (Lm/W)	80
Correlated Color Temp (K)	2710
Color Rendering Index (CRI)	92
Beam Angle	106°
Spacing Criteria	1.23

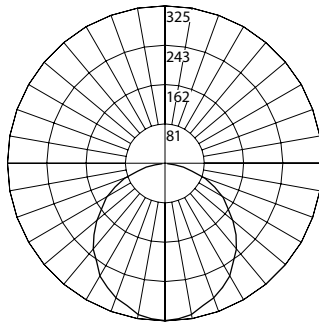

Intensity Summary (Candle Power)

Angle	Mean CP
0	325
5	322
15	307
25	279
35	242
45	199
55	152
65	103
75	54
85	11
90	1

CCT Data Multiplier

DLE621203KSQ	1.024
DLE621204KSQ	1.044
DLE621205KSQ	1.071

Cone of Light Tabulation

Mounted height (Feet)	Footcandles Beam Center	Diameter (Feet)
4	20.2	10.5
6	9.0	15.8
8	5.1	21.1
10	3.2	26.3
12	2.2	31.6
14	1.6	36.9
16	1.3	42.2

Zonal Lumen Summary

Zone	Lumens	% of Luminaire
0-30	246	28.6%
0-40	397	46.3%
0-60	686	79.9%
0-90	858	100%
90-180	0	0%
0-180	858	100%

Fixture tested per LM-79-08. Photometric data is of the performance of a representative fixture. Results may vary in the field.

Performance Data

Model Number	Lumens	Watts	Lumens/Watt
DLE621202KRD	982	13.9	70.6
DLE621203KRD	1005	13.9	72.3
DLE621204KRD	1025	13.9	73.7
DLE621205KRD	1052	13.9	75.7
DLE621202KSQ	858	10.8	79.4
DLE621203KSQ	879	10.8	81.4
DLE621204KSQ	896	10.8	83.0
DLE621205KSQ	919	10.8	85.1

Recommended Dimmers*

Lutron Toggler TGCL-153P
Lutron Skylark SCL-153P
Lutron DIVA DVCL-153P
Lutron DIVA DVELV-300P
Lutron DIVA DVELV-303P

*Not a complete list. Check compatibility before installation.

Ordering Information

Example: DLE621203KRDPWH

Series	Version	Voltage	CCT's	Trim Shape	Trim Color
DLE6	2 (Version 2)	120	2K (2700 K)	RD (Round)	WH (White)
			3K (3000 K)	SQ (Square)	
			4K (4000 K)		
			5K (5000 K)		

Specifications and dimensions subject to change without notice

Accessories

accessories sold separately

6" ROUGH IN TEMPLATE	ROUGHIN-TEMPLATE-6
6" BLACK TRIM RING	DLE6-TR-BK
6" AGED COPPER TRIM RING	DLE6-TR-AC
6" BRUSHED NICKEL TRIM RING	DLE6-TR-NK
6" BLACK SQUARE TRIM RING	DLE6-TR-SQ-BK
6" AGED COPPER SQUARE TRIM RING	DLE6-TR-SQ-AC
6" BRUSHED NICKEL SQUARE TRIM RING	DLE6-TR-SQ-NK
24" Extension Cable	DLE-EXTCABLE-24
10' Extension Cable	DRIVER-EXTCABLE-10
20' Extension Cable	DRIVER-EXTCABLE-20