

sunlite® INSTALLATION INSTRUCTIONS

LED PORTABLE WORK LIGHT FIXTURE | Models: 85263-SU

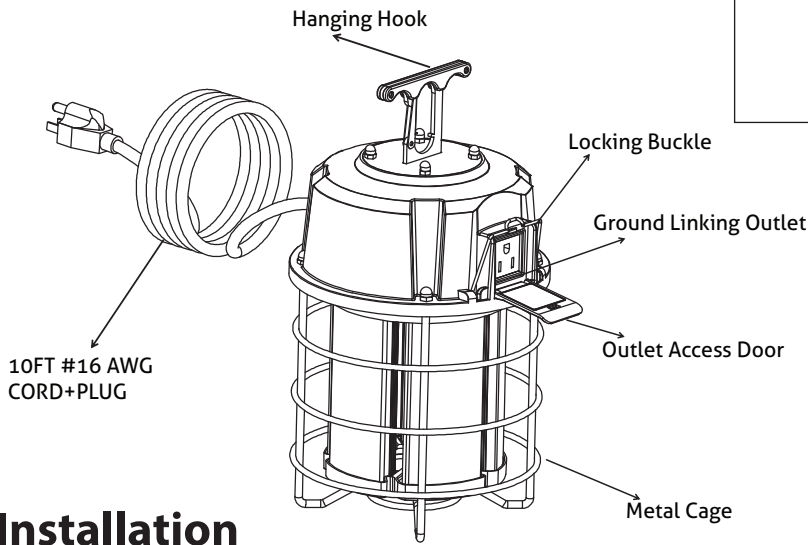

Please read and understand this entire manual before attempting to assemble, operate or install the product.



WARNING: Avoid fire or electric shock. Follow installation instructions carefully. If unsure about electrical installation, consult a qualified electrician. Ground fixture to avoid potential electric shock. Handle metal parts carefully to prevent cuts. To avoid a hazard to children, account for all parts and destroy all packing material. This product is suitable for indoor and outdoor applications. Ambient operating temperature -30°C – 60°C (-22°F – 140°F). Suitable for damp locations. DO NOT use with extension cord near water or wherever water may accumulate.

CAUTION: Turn off the power at fuse or circuit breaker box before installation and maintenance. NOTE: This fixture is suitable for 120Volt fused circuits. THIS FIXTURE BODY IS ONE PIECE, DO NOT DISASSEMBLE OR MAKE ALTERATIONS.

This device complies with part 15 of the FCC Rules. Operation is subject to the following two conditions: (1) this device may not cause harmful interference, and (2) this device must accept any interference received, including that may cause undesired operation.

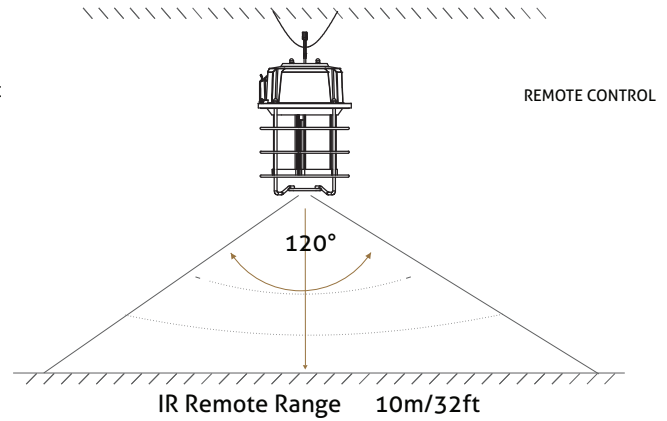

Installation

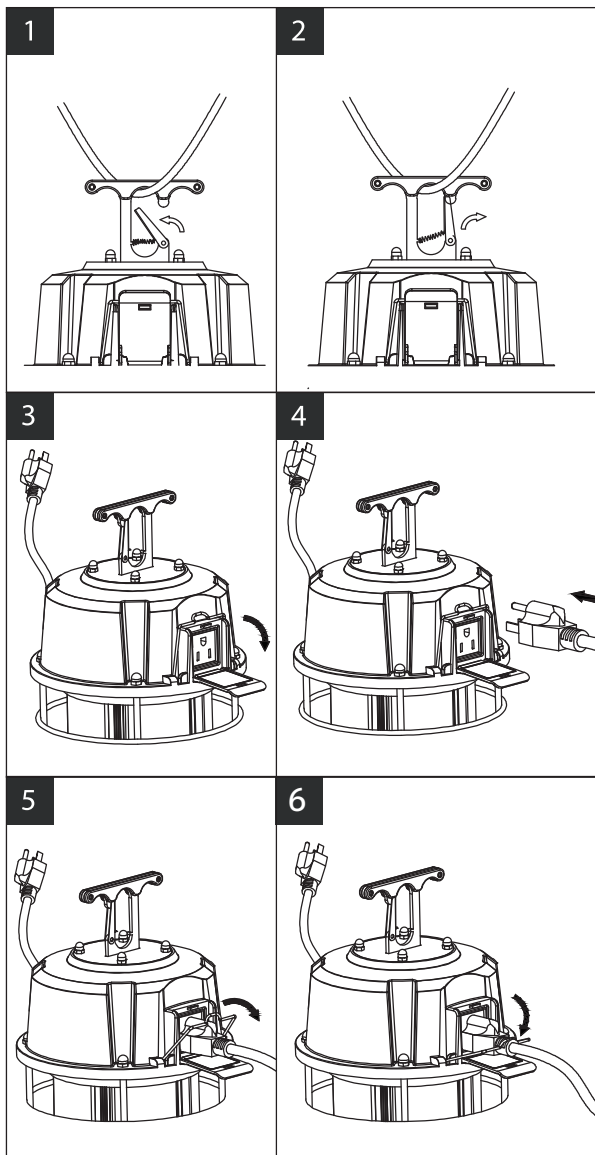

STEP 1. Place the work light up to the hanging hardware, push the latch of the carabiner clip against the hanging hardware until it opens (Fig 1) and captures the hardware (Fig 2).

STEP 2. Plug fixture power cord into outlet and turn on using included remote control.

Linking Additional Units (Optional)

Install each additional unit as in Step 1. When adding units, turn cage light off prior to adding the additional units. Max 9pcs x 100W can be daisy chained and must NOT EXCEED 10A.

Open the outlet access door in order to gain access to the grounded outlet (Fig 3). Plug each additional light into the preceding unit (Fig. 4), Lock each plug in place by closing the locking buckle onto the plug (Fig 5-6). Repeat as necessary. Plug in the first unit and use the remote to turn the lights on individually one by one after installing all the units needed.

Sunshine Lighting Company

744 Clinton Street Brooklyn, NY 11231, USA

T. 718.768.7000

F. 718.768.0970

www.sunlite.com