

PRODUCT:

5555 SURFACE MOUNT LED

FEATURES:

5.5 mm x 5.5 mm x 4.68 mm surface-mount LED
 60° emission angle
 95 min Ra

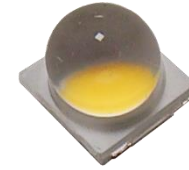

DESCRIPTION

YUJILED S® high CRI 5555 SMD provides a high CRI, high efficacy solution in a compact form factor. Providing 95 CRI (min), this mid-power LED can be used in a variety of applications demanding high color quality and even light distribution.



ELECTRICAL-OPTICAL CHARACTERISTICS (T _A = 25 °C)							
PARAMETER	SYMBOL	VALUE			UNIT	TOLERANCE	CONDITION
		MIN.	TYP.	MAX.			
Forward voltage	V _f	2.8	--	3.2	V	±0.05	I _f = 60mA
Luminous flux	Φ _{3200K}	18	--	20	lm	--	I _f = 60mA
	Φ _{5600K}	20	--	22			
Correlated color temperature	CCT _{3200K}	2900	--	3320	K	--	I _f = 60mA
	CCT _{5600K}	4800	--	6000			
Color rendering index	Ra	95	--	--	--	±1	I _f = 60mA
TCS R9 (CRI Red)	R9	--	90	--	--	--	I _f = 60mA
Chromaticity coordinates	(X,Y)*	--	--	--	--	±0.0015	--
Reverse current	I _r	--	--	1	µA	±0.1	V _r = 5V
Viewing angle	2θ1/2	--	60	--	Deg	±3	I _f = 60mA

*Yuji Everfine standard equipment shall prevail.

ORDERING INFORMATION			
PART NUMBER	CCT	CHROMATICITY BINS	VOLTAGE RANGE
YJ-BC-5555L-G02-32	2900K-3320K	29, 31, 33	0.1 V
YJ-BC-5555L-G02-56	4800K-6000K	49, 52, 55, 58	0.1 V
YJ-BC-5555L-G02-XX	CUSTOM		

VOLTAGE BIN CODES				
BIN	V28	V29	V30	V31
V _F	2.8-2.9	2.9-3.0	3.0-3.1	3.1-3.2



ABSOLUTE MAXIMUM RATING (T _A = 25 °C)			
PARAMETER	SYMBOL	LIMIT	UNIT
Power Consumption	P _D	300	mW
DC Forward Current (pulsed)*	I _{Fp}	180**	mA
DC Forward Current	I _F	90	mA
Reverse Voltage	V _R	5	V
Junction Temperature	T _j	125	°C
Solder Point Temperature***	T _s	105	°C
Operating Temperature	T _{opr}	-40 ~ +85	°C
Storage Temperature	T _{stg}	-30 ~ +85	°C
Soldering Temperature	T _{sol}	190 ± 5	°C
Reflow Cycles Allowed	--	2	--

* Pulse width ≤ 0.1ms, Duty ≤ 1/10.

** Theoretical data.

*** See page 4 for solder point definition.

CHROMATICITY BINS & COORDINATES									
CCT	BIN	CIE 1931 COORDINATES							
		X0	Y0	X1	Y1	X2	Y2	X3	Y3
5700-6000K	58A	0.3216	0.3381	0.3221	0.3315	0.3280	0.3370	0.3279	0.3434
	58B	0.3221	0.3315	0.3224	0.3260	0.3282	0.3311	0.3280	0.3370
	58C	0.3224	0.3260	0.3228	0.3200	0.3283	0.3250	0.3282	0.3311
5400-5700K	55A	0.3279	0.3434	0.3280	0.3370	0.3347	0.3429	0.3348	0.3491
	55B	0.3280	0.3370	0.3282	0.3311	0.3346	0.3365	0.3347	0.3429
	55C	0.3282	0.3311	0.3283	0.3250	0.3345	0.3301	0.3346	0.3365
5100-5400K	52A	0.3348	0.3491	0.3347	0.3429	0.3423	0.3492	0.3427	0.3556
	52B	0.3347	0.3429	0.3346	0.3365	0.3419	0.3429	0.3423	0.3492
	52C	0.3346	0.3365	0.3345	0.3301	0.3414	0.3363	0.3419	0.3429
4800-5100K	49A	0.3427	0.3556	0.3423	0.3492	0.3509	0.3562	0.3515	0.3623
	49B	0.3423	0.3492	0.3419	0.3429	0.3502	0.3498	0.3509	0.3562
	49C	0.3419	0.3429	0.3414	0.3363	0.3495	0.3436	0.3502	0.3498
3200-3320K	33A	0.4194	0.4042	0.4162	0.3962	0.4235	0.3989	0.4269	0.4069
	33B	0.4162	0.3962	0.4130	0.3882	0.4200	0.3909	0.4235	0.3989
	33C	0.4130	0.3882	0.4098	0.3802	0.4166	0.3829	0.4200	0.3909
3050-3200K	31A	0.4269	0.4069	0.4235	0.3989	0.4335	0.4027	0.4371	0.4105
	31B	0.4235	0.3989	0.4200	0.3909	0.4297	0.3945	0.4335	0.4027
	31C	0.4200	0.3909	0.4166	0.3829	0.4261	0.3866	0.4297	0.3945
2900-3050K	29A	0.4371	0.4105	0.4335	0.4027	0.4442	0.4064	0.4483	0.4143
	29B	0.4335	0.4027	0.4297	0.3945	0.4403	0.3985	0.4442	0.4064
	29C	0.4297	0.3945	0.4261	0.3866	0.4365	0.3905	0.4403	0.3985

CHROMATICITY BINS & COORDINATES

CIE 1931 COORDINATES

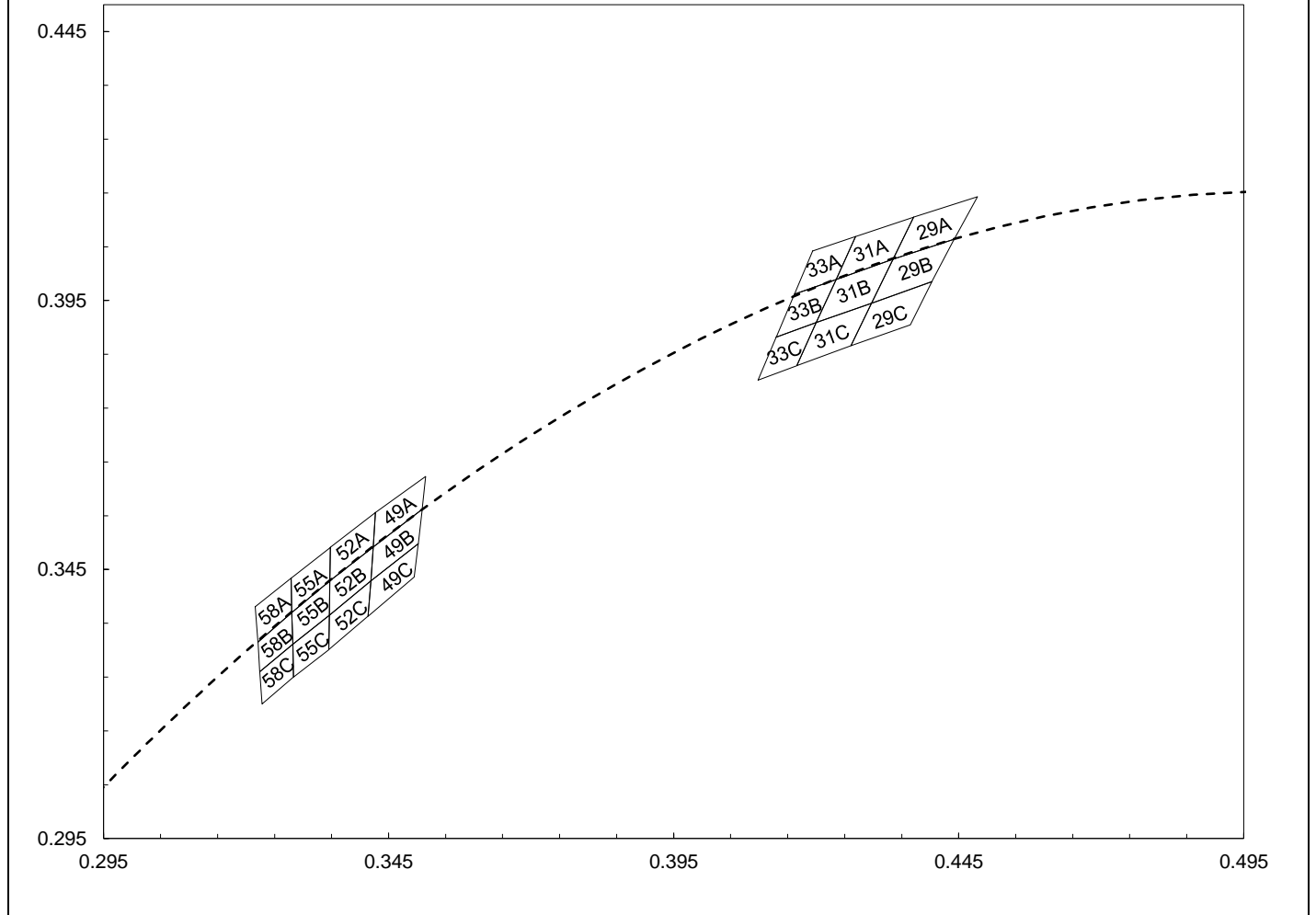

PACKAGE LAYOUT

All dimensions in mm, tolerance unless mentioned is ± 0.1 mm.

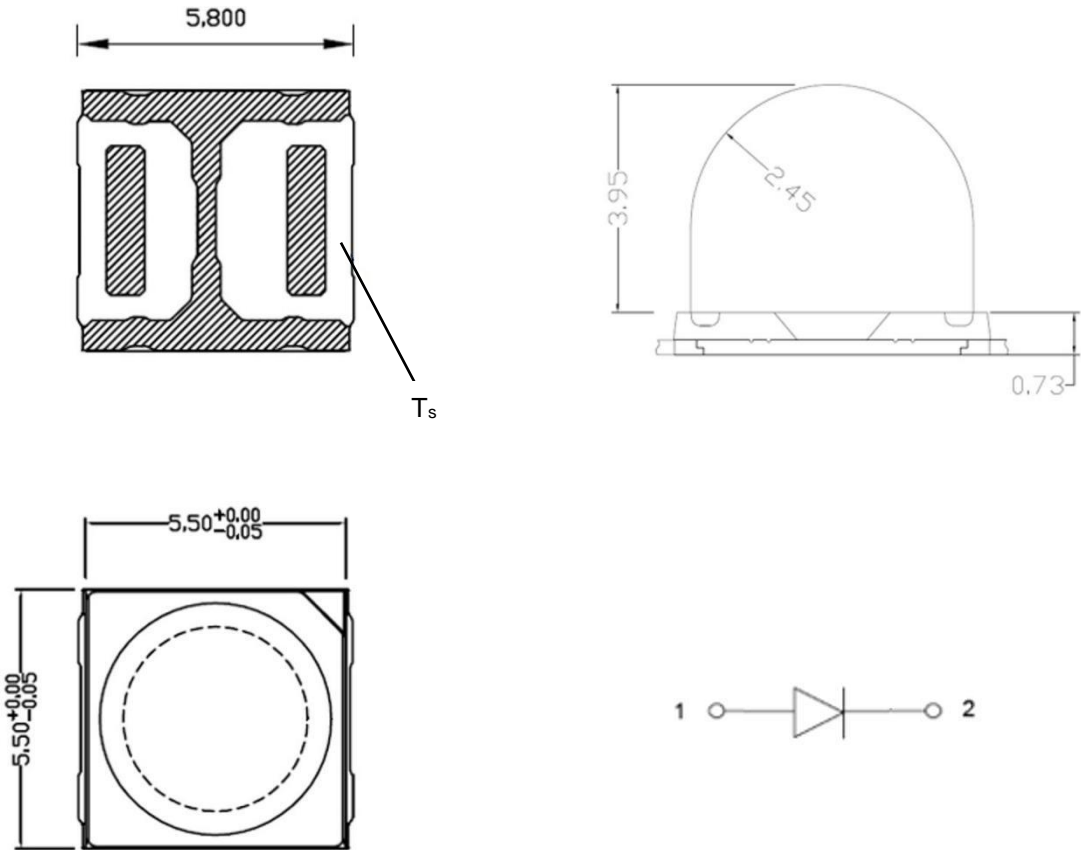

PACKAGE MATERIALS

ITEM	DESCRIPTION
DIE MATERIAL	InGaN
LEAD FRAME MATERIAL	PCT
ENCAPSULANT RESIN MATERIAL	SILICONE + PHOSPHOR
ELECTRODES MATERIAL	SILVER-PLATED COPPER

RECOMMENDED SOLDER PAD LAYOUT

All dimensions in mm, tolerance unless mentioned is ± 0.1 mm.

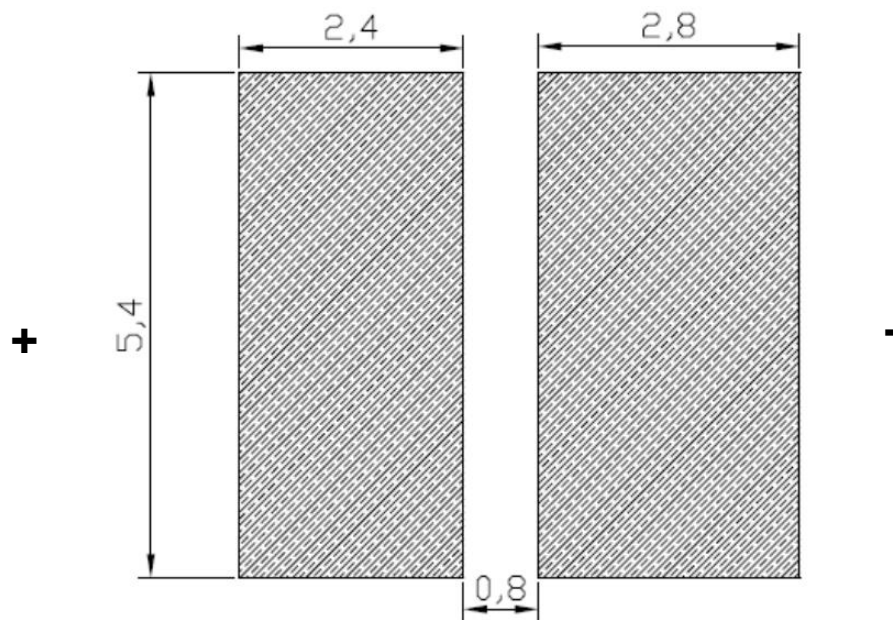

CHARACTERISTIC CURVES

ALL CHARACTERISTIC CURVES ARE FOR REFERENCE ONLY AND NOT GUARANTEED

FORWARD CURRENT VS FORWARD VOLTAGE ($T_A = 25^\circ\text{C}$)

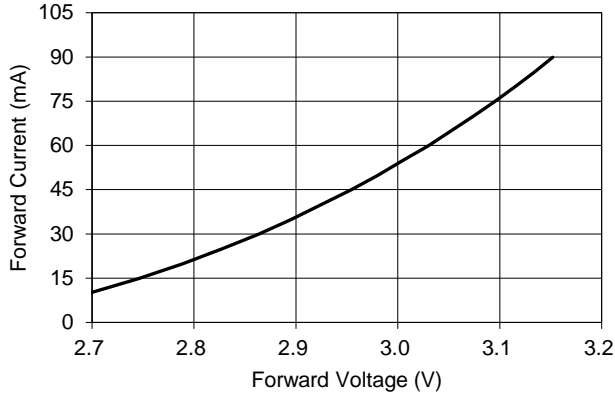

FORWARD CURRENT VS RELATIVE LUMINOUS OUTPUT ($T_A = 25^\circ\text{C}$)

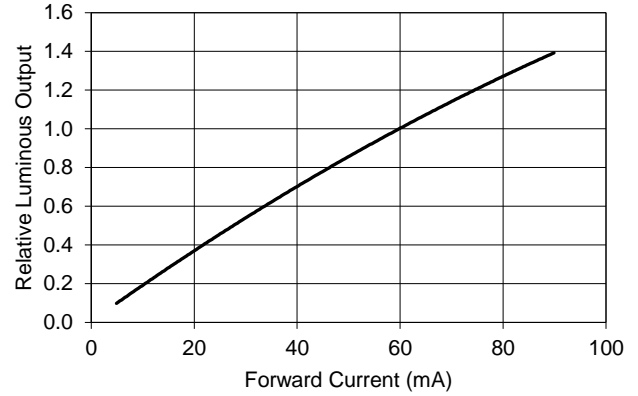

SOLDER POINT TEMPERATURE VS FORWARD VOLTAGE ($I_F = 60\text{ mA}$)

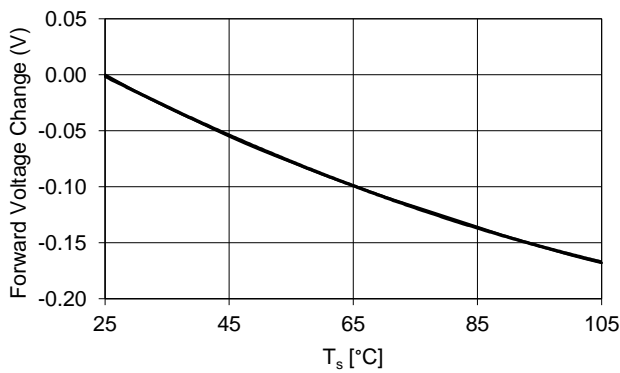

SOLDER POINT TEMPERATURE VS RELATIVE LUMINOUS OUTPUT ($I_F = 60\text{ mA}$)

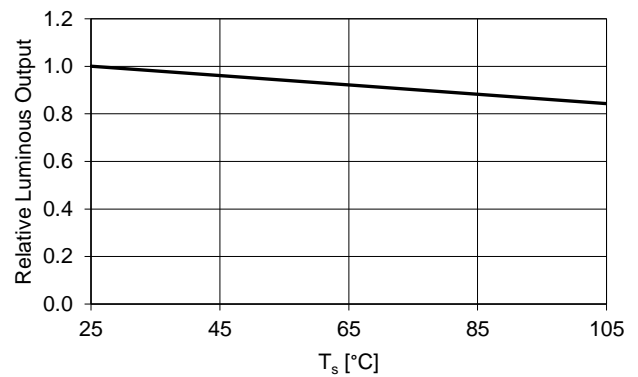

FORWARD CURRENT VS CHROMATICITY SHIFT (5600K, $T_A = 25^\circ\text{C}$)

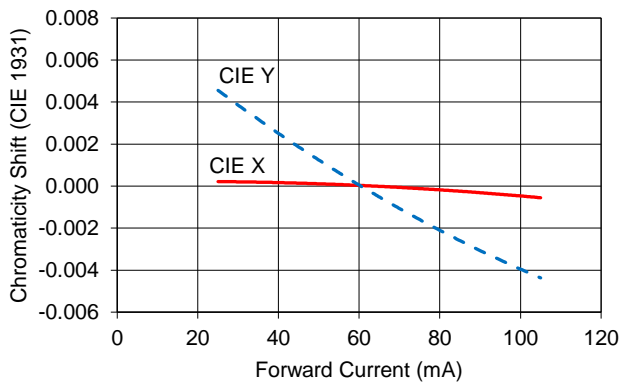

FORWARD CURRENT VS CHROMATICITY SHIFT (5600K, $T_A = 25^\circ\text{C}$)

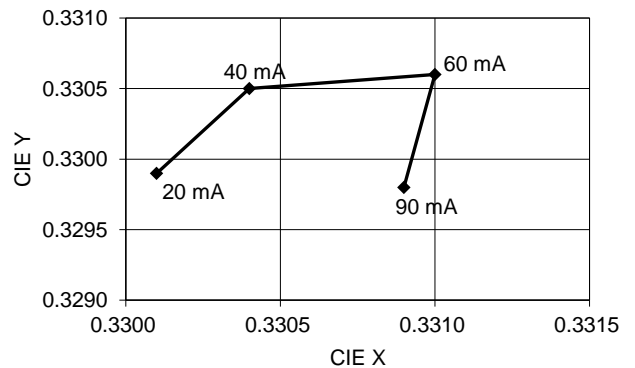

CHARACTERISTIC CURVES (CONTINUED)

SOLDER POINT TEMPERATURE VS CHROMATICITY (5600K, I_F = 60 mA)

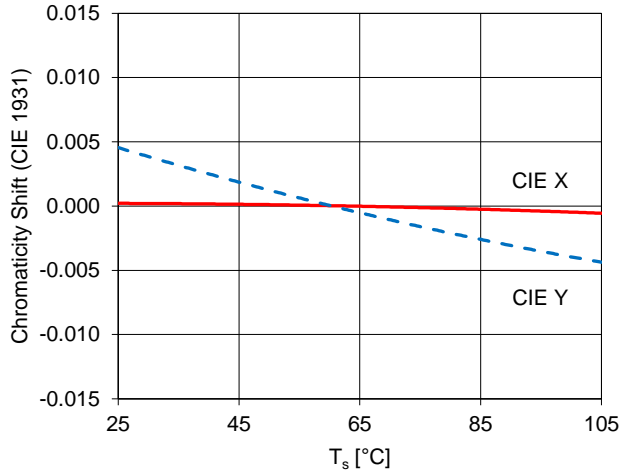

SOLDER POINT TEMPERATURE VS CHROMATICITY (5600K, I_F = 60 mA)

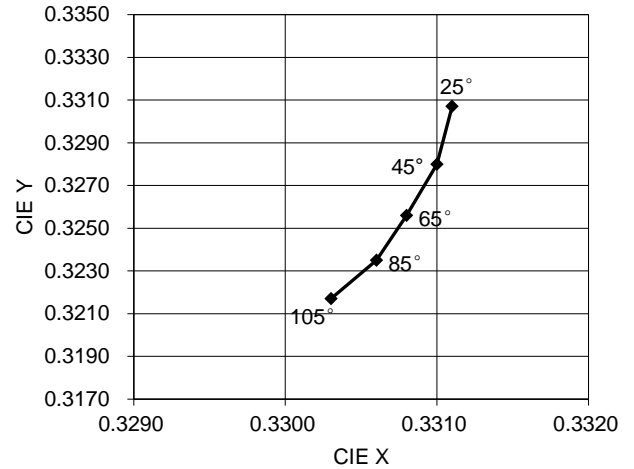

FORWARD CURRENT DERATING BASED ON SOLDER POINT

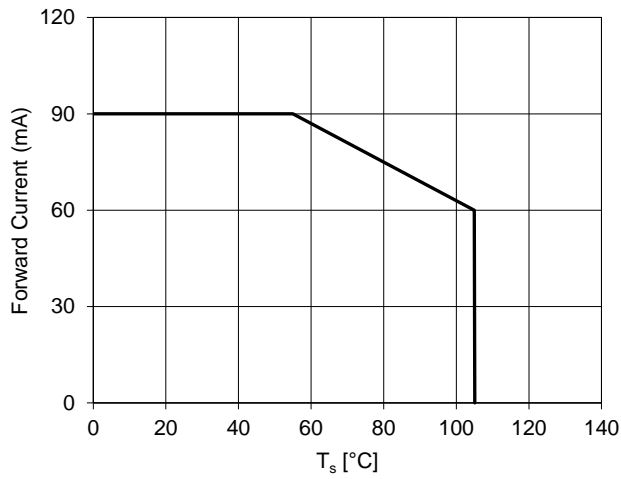

NOTE: DE-RATING CURVES ARE MEANT FOR RECOMMENDATION ONLY AND ARE NOT MEANT TO PROVIDE GUARANTEES OF PRODUCT STABILITY AND LONGEVITY

TYPICAL SPATIAL DISTRIBUTION (T_A = 25°C, I_F = 60 mA)

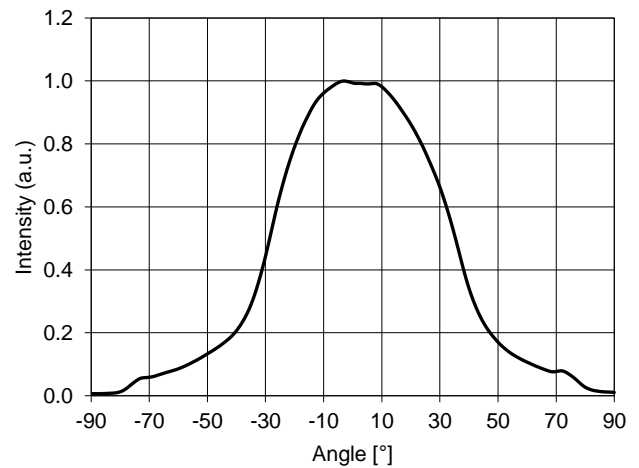

TYPICAL SPECTRAL DISTRIBUTION GRAPHS

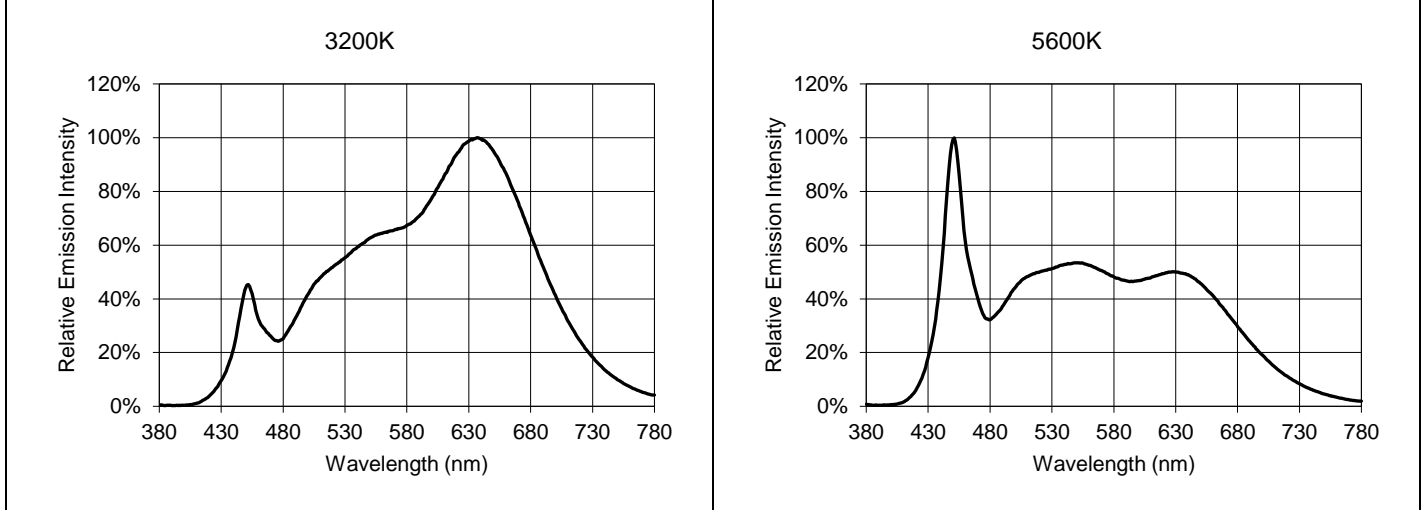

REFLOW PROFILE

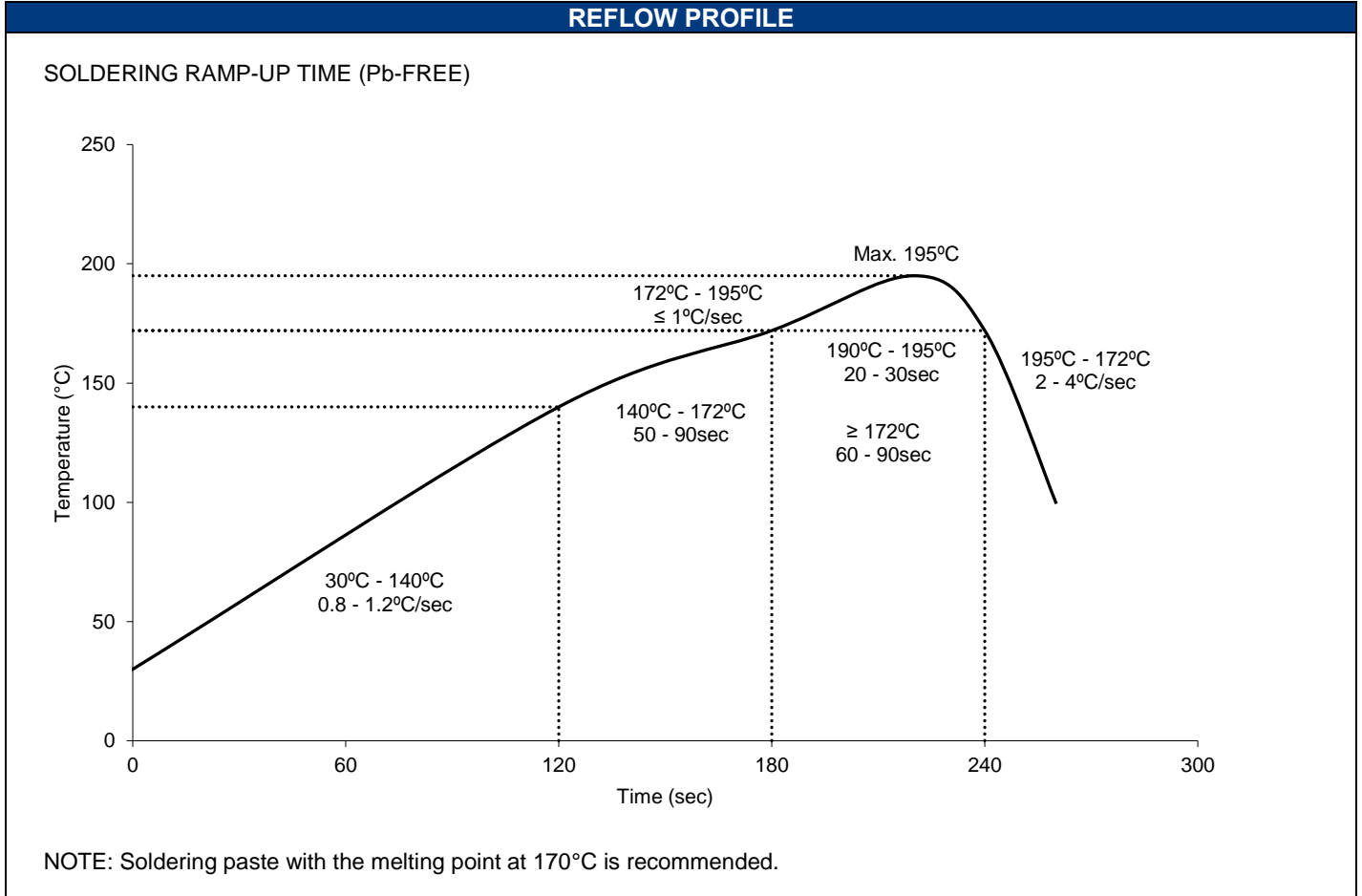

INSTRUCTIONS FOR SMT

Problems caused by improper selection of collet

Choosing the right collet is important in ensuring product quality after SMT. LEDs are different from other electronic components, as they are not only concerned with electrical output but also optical output. This characteristic makes LEDs more fragile in the process of SMT. If the collet's lowering height is not well set, it will bring damage to the gold wire at the time of collet's pick-and-place process which can cause the LED to not illuminate, flicker or contribute to other quality problems, some of which may not be immediately detectable.

Collet selection

During SMT, please choose the collet that has larger outer diameter than the lighting area of lens, in order to avoid damage the gold wire inside the LED. Different collets fit for different products, please refer to the following figures below.



Setting the height of the collet is crucial in order to avoid damage to the top view SMD. If the collet setting is set to too low of an altitude, the collet will press down on the SMD, causing damage or breakage to the encapsulant and cause distortion or breakage of the gold wire.

Other notes of caution:

- No pressure should be exerted to the silicone shell of the SMD under high temperature.
- Do not scratch or wipe the lens since the lens and gold wire inside are rather fragile and cross out easy to break.
- LED should be used as soon as possible when being taken out of the original package, and should be stored in anti-moisture and anti-ESD package.
- This usage and handling instructions are for reference only.

TAPE SPECIFICATIONS

TAPE DIMENSIONS (UNIT: MM)

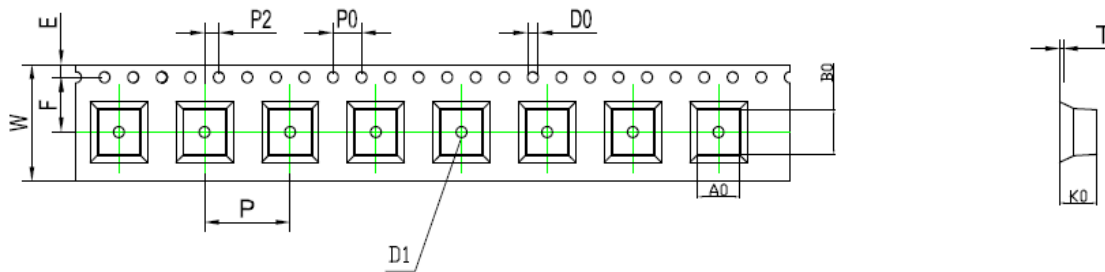

Symbol	A0	B0	K0	P0	P	P2	Length / Reel
Spec	5.80 ± 0.10	6.10 ± 0.10	4.90 ± 0.10	4.00 ± 0.10	12.0 ± 0.10	2.00 ± 0.10	4000
Symbol	W	T	E	F	D0	D1	--
Spec	16.0 ± 0.30	0.40 ± 0.05	1.75 ± 0.10	7.50 ± 0.10	1.50 ± 0.10	1.50 ± 0.10	--

TAPE LAYOUT (NOT DRAWN TO SCALE)

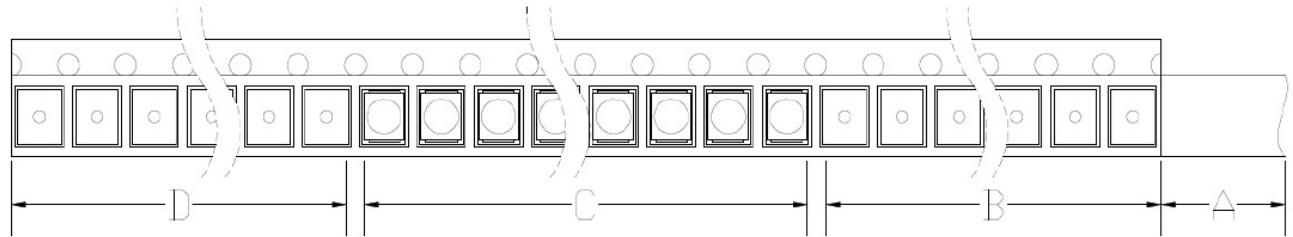

- A: COVER TAPE, 300 MM;
- B: EMPTY LEADER, 600 MM;
- C: LED, 1000 PCS;
- D: EMPTY TRAILER, 600 MM;

REEL SPECIFICATIONS

REEL DIMENSIONS TOP (UNIT: MM)

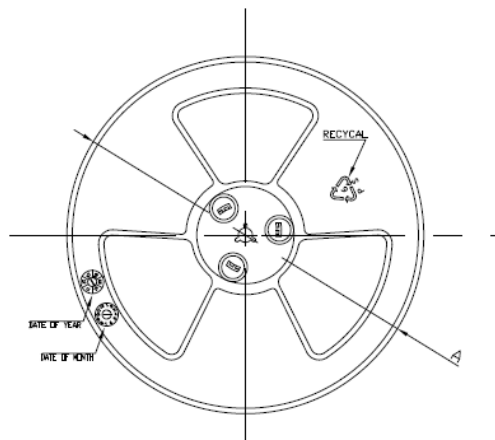

REEL DIMENSIONS SIDE (UNIT: MM)

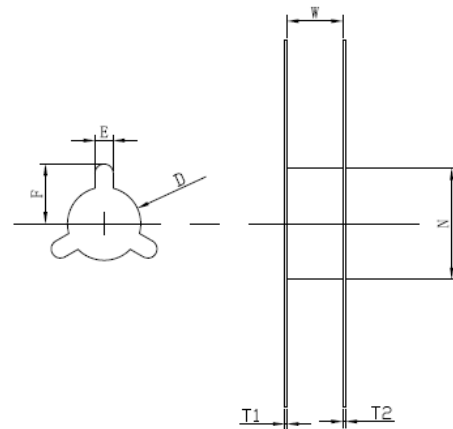

Spec	12	16	24	32	44	56	72
E ± 0.5	2.3	2.3	2.3	2.3	2.3	2.3	2.3
F ± 0.5	10.75	10.75	10.75	10.75	10.75	10.75	10.75
W ± 0.2	12.4	16.4	24.5	32.4	44.4	56.4	72.4
T1 ± 0.3	2.2	2.2	2.2	2.2	2.2	2.2	2.2
T2 ± 0.3	2.2	2.2	2.2	2.2	2.2	2.2	2.2
A ± 0.2	Ø330	Ø330	Ø330	Ø330	Ø330	Ø330	Ø330
N ± 0.3	Ø100	Ø100	Ø100	Ø100	Ø100	Ø100	Ø100
D ± 0.3	13.3	13.3	13.3	13.3	13.3	13.3	13.3

LOT NUMBERING SCHEME

Yuji LED uses two formats for lot numbering purposes:

1) YYYY-MM-XXX-Z

YYYY: 4-digit manufacturing year
MM: 2-digit manufacturing month
XXX: 3-digit inventory number (000 – 999)
Z: internal alphanumeric code

2) YYYYMMXXX

YYYY: 4-digit manufacturing year
MM: 2-digit manufacturing month
XXX: 3-digit inventory number (000 – 999)

SHIPPING INFORMATION

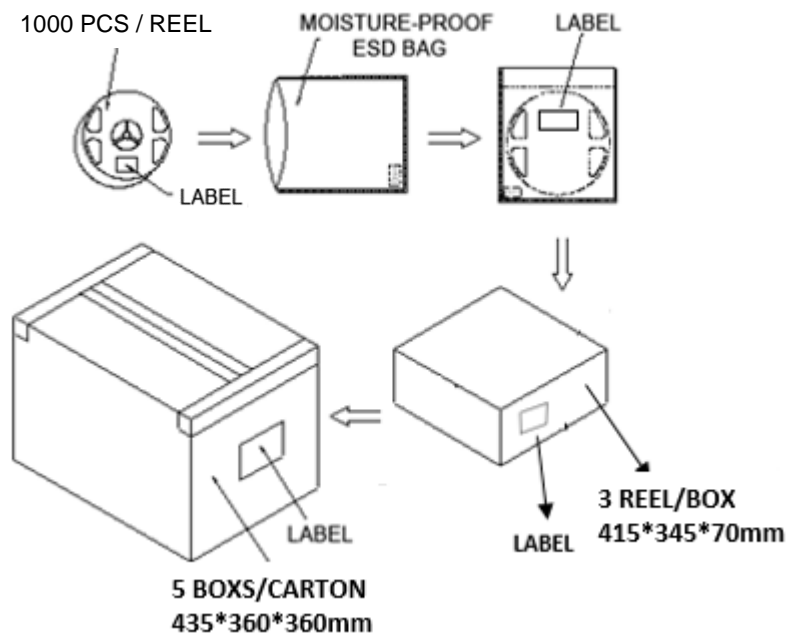

NOTES:

1. Reeled products (max 1,000 pcs / reel) are packed in a moisture-proof bag along with a moisture desiccant pack.
2. Each inner box contains up to 3 moisture-proof bag (total maximum number of SMDs is 3,000pcs). Box package size: 415 mm x 345 mm x 70 mm.
3. Each outer package contains 5 inner boxes. Box size: 435 mm x 360 mm x 360 mm.
4. Outer package is sealed with protective bubble wrap and foam. (Part numbers, lot numbers, quantity should appear on the label on the moisture-proof bag, part numbers).
5. This packaging merely intended as a reference for standard quantity orders only – please note that actual packaging can differ depending on the order circumstances.