



P3230007

Surface Mount Device



Applications

- Hyperspectral device
- Reference / Background light source
- Spectral tuning and calibration
- Visible and infrared optical analyser



Features

- Full-spectrum coverage accurate simulation for CIE D65
- Homogeneous spectral power distribution
- 5.0mm × 5.0mm package
- Enhanced optical radiation density

[About Yujileads[®]](#)

Rev Version: 2.0

P3230007.00

Table of Contents

General description	3
Ordering information	5
Characteristics	6
Package material and dimension.....	7
Characteristic graph	8
Reflow profile	14
SMT instruction	15
About Yujileds	16

General description

Yujileds® CIE Illuminant Technology: Accurate Simulation of CIE Illuminant with Only Single LED.

With the iteration of LED technology, especially the technological updating of Yujileds® phosphors. As a leader in LED spectroscopy engineering, we successfully simulated and commercialized CIE illuminators using a single LED for the first time in the world. Traditional light sources, such as fluorescent tubes, have not been able to achieve accurate simulation at the spectral level on simulating CIE illuminants, but Yujileds® has successfully achieved accurate simulation by using our precise control of the LED spectrum.

Spectral accuracy index (SAI)

At present, most of the spectrum simulation products on the market are still in the stage of qualitative description of the degree of accuracy. There is a lack of a quantitative method for calculating spectral accuracy on the market. When Yujileds® developed the CIE illuminant series, we used the Spectral Accuracy Index (SAI) to describe simulation accuracy and control product quality. This ensures that CIE illuminant has accurate parameters from R&D to production.

To calculate the spectral accuracy index, we need use two spectral power distributions, one of the products and the other of reference. The formula is shown as follow:

$$SAI = 100 - \left(\frac{\sqrt{\sum_{Min}^{Max} (C_i - Ref_i)^2}}{\sqrt{\sum_{Min}^{Max} Ref_i^2}} \times 100 \right)$$

Among:

C = normalized measured spectrum

Ref = normalized reference spectrum

Max = maximum wavelength

Min = minimum wavelength

CIE standard illuminant D65 simulation

CIE Illuminant D65 is a standardized reference light source developed by the International Commission on Illumination (CIE) to represent average daylight conditions at a color temperature of approximately 6500K. It is commonly used as a benchmark for color-

related applications, such as color matching, quality control, and color reproduction in industries like graphic arts, printing, and photography. As a fundamental component in color science, CIE Illuminant D65 plays a crucial role in ensuring consistent and reliable color communication across different media and visual contexts.

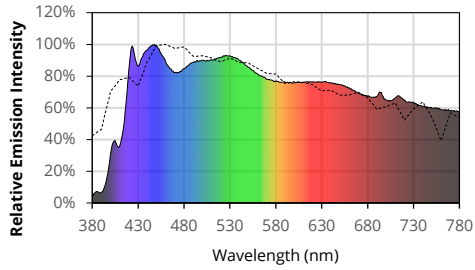

Light source	Spectral accuracy index (SAI, 380nm – 780nm)
Yujileds® CIE D65	82
6500K high CRI LED	53
6500K full spectrum LED	62

This LED also supports the unique service/certification by Yujileds® as described below.



RoHS 2011/65/EU compliance



CE compliance

Ordering information

PRODUCT CODE	CCT	CHROMATICITY BINS	VOLTAGE RANGE
P3230007.01	6500K	-	0.2V

Characteristics

Electrical-optical characteristics ($T_A = 25^\circ\text{C}$, 240mA)

PARAMETER	SYMBOL	VALUE			UNIT	TOLERANCE
		MIN.	TYP.	MAX.		
Forward voltage	V_F	-	9	-	V	± 0.1
Luminous flux	Φ_v	-	67	-	lm	-
Radiant flux	Φ_e	-	407	-	mW	-
Correlated color temperature⁽¹⁾	CCT	-	6500	-	K	-
Spectral accuracy index (SAI, 380nm - 780nm)	SAI	-	82	-	-	-
Reverse current	I_r	-	-	10	μA	$\pm 0.1 (V_r = 15\text{V})$
View angle	$2\theta_{1/2}$	-	120	-	Deg	± 5

(1). CCT is listed for reference only.

Absolute maximum ratings ($T_A = 25^\circ\text{C}$)

PARAMETER	SYMBOL	LIMIT	UNIT
Power Consumption	P_D	5400	mW
DC Forward Current (pulsed)⁽¹⁾	I_{FP}	600 ⁽²⁾	mA
DC Forward Current	I_F	480	mA
Reverse Voltage	V_R	15	V
Junction Temperature⁽³⁾	T_j	105	$^\circ\text{C}$
Solder Point Temperature³	T_s	60	$^\circ\text{C}$
Operating Temperature	T_{opr}	-25 ~ +60	$^\circ\text{C}$
Storage Temperature	T_{stg}	-30 ~ +85	$^\circ\text{C}$
Soldering Temperature	T_{sol}	260 \pm 5	$^\circ\text{C}$
Reflow Cycles Allowed	-	2	-

(1). Pulse width $\leq 0.1\text{ms}$, duty $\leq 1/10$.

(2). Theoretical data.

(3). Recommend to control as lower as possible to 25°C to ensure the best optical performance in the long term, see page [Package material and dimension](#).

Package material and dimension

Package layout

All dimensions in mm, tolerance unless mentioned is ± 0.1 mm.

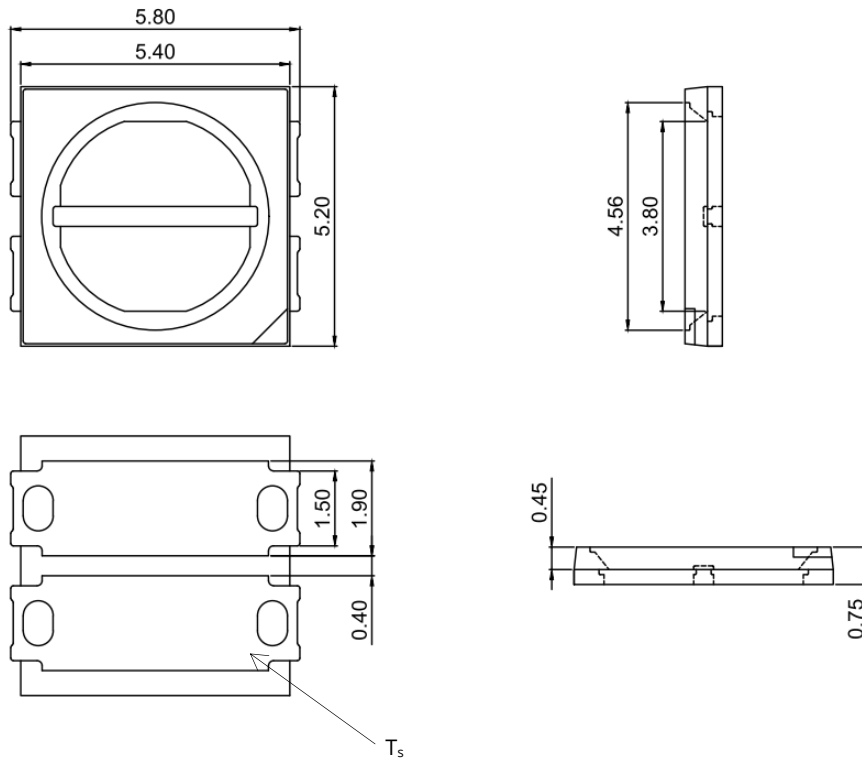

Package materials

ITEM	DESCRIPTION
Die material	GaN
Lead frame material	EMC
Encapsulant resin material	Silicon + Phosphor
Electrodes material	Silver-plated copper

Characteristic graph

Typical spectral power distribution

All characteristic curves are for reference only and not guaranteed.

Normalized

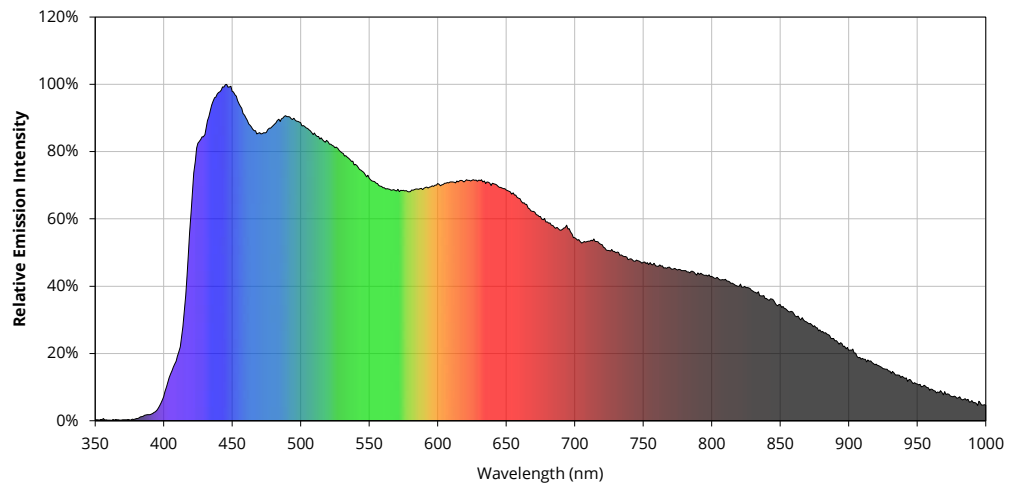

Absolute by different currents

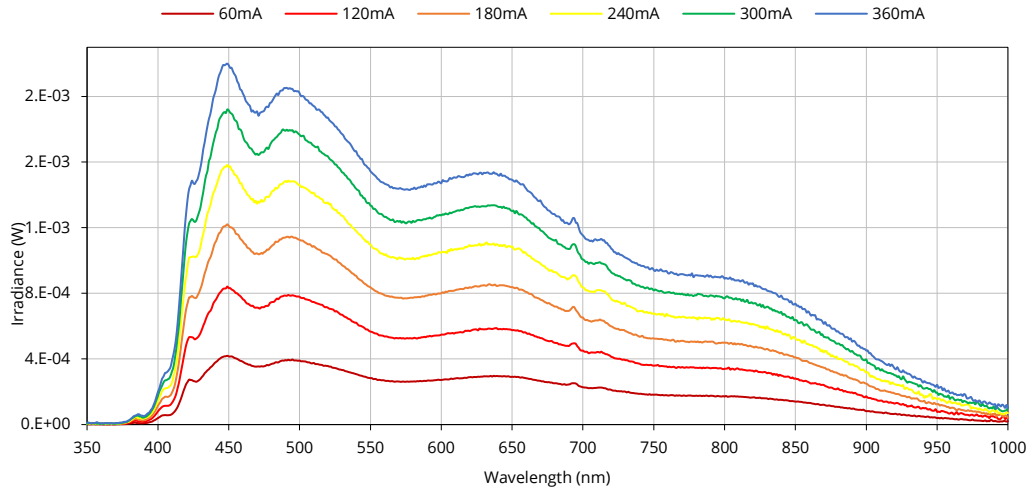

Characteristic graph

Forward current

All characteristic curves are for reference only and not guaranteed.

Vs. forward voltage

($T_A = 25^\circ\text{C}$)

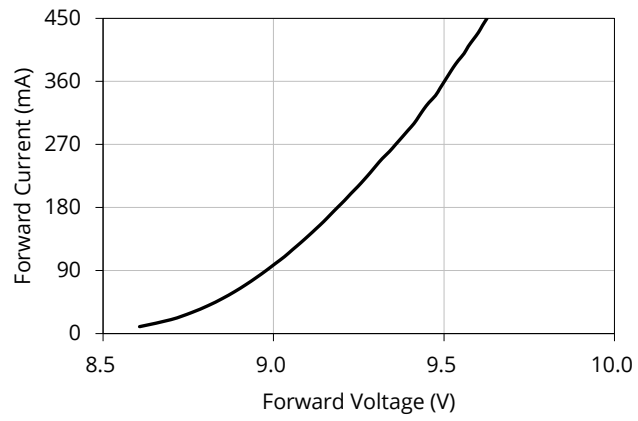

Vs. relative luminous flux

($T_A = 25^\circ\text{C}$)

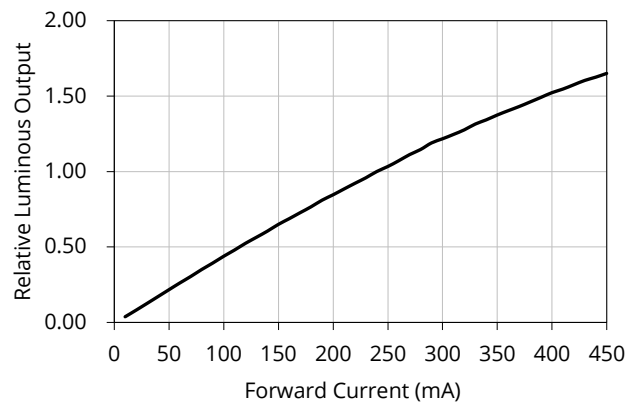

Characteristic graph

Forward current (continued)

All characteristic curves are for reference only and not guaranteed.

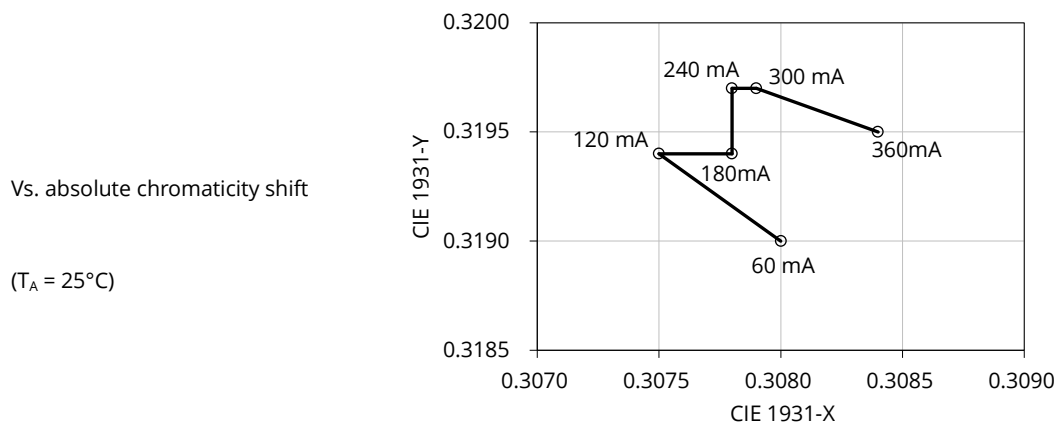
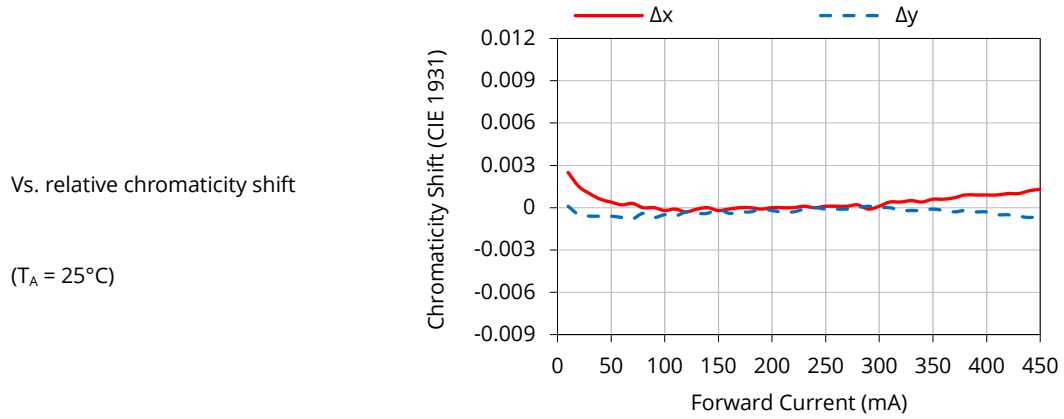

Characteristic graph

Solder point temperature (T_s)

All characteristic curves are for reference only and not guaranteed.

Vs. forward voltage

($I_F = 240\text{mA}$)

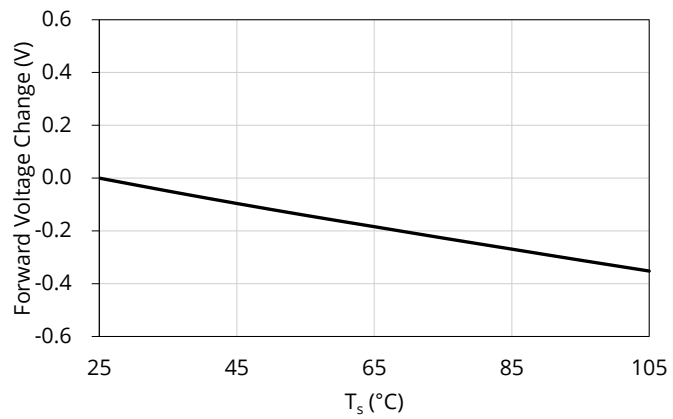

Vs. relative luminous flux

($I_F = 240\text{mA}$)

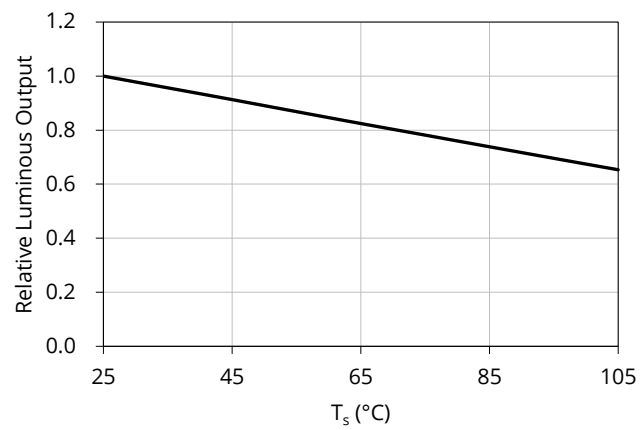

Characteristic graph

Solder point temperature (T_s) (continued)

All characteristic curves are for reference only and not guaranteed.

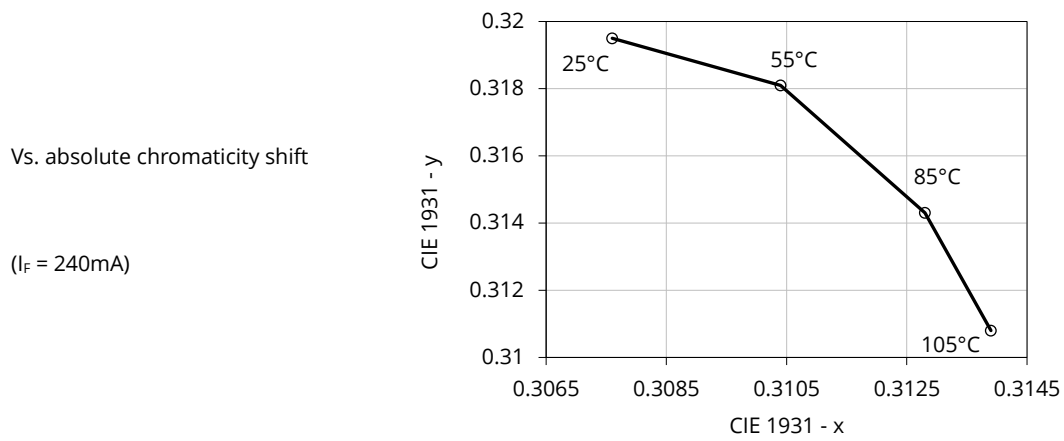
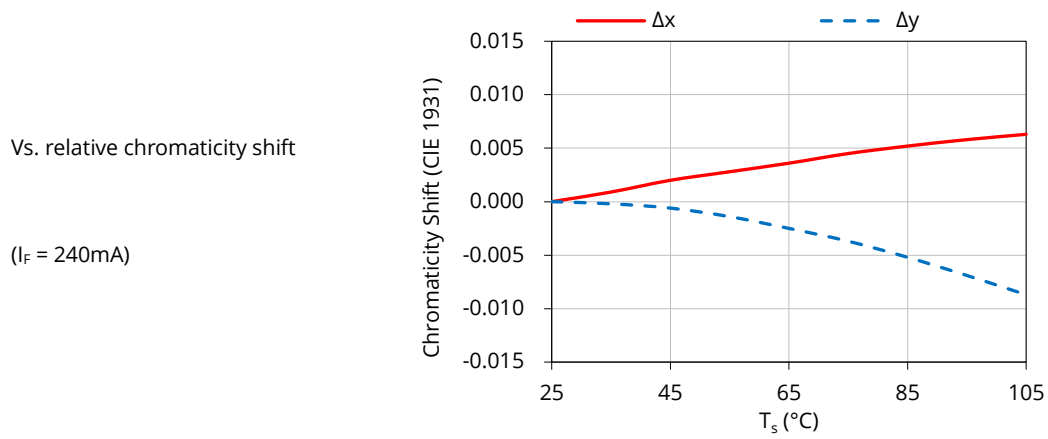

Characteristic graph

Spatial distribution ($T_A = 25^\circ\text{C}$, $I_F = 240\text{ mA}$)

All characteristic curves are for reference only and not guaranteed.

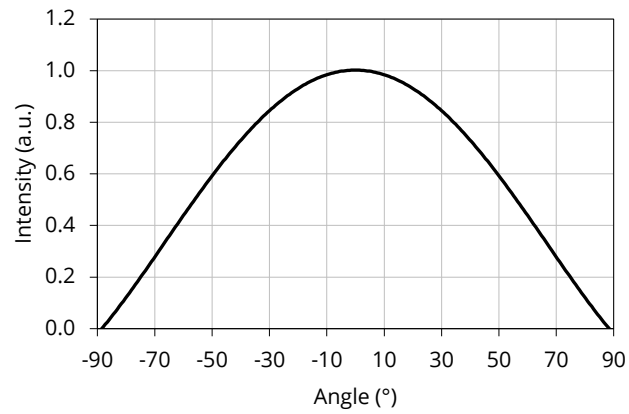

Reflow profile

Recommended solder pad layout

All dimensions in mm, tolerance unless mentioned is ± 0.1 mm.

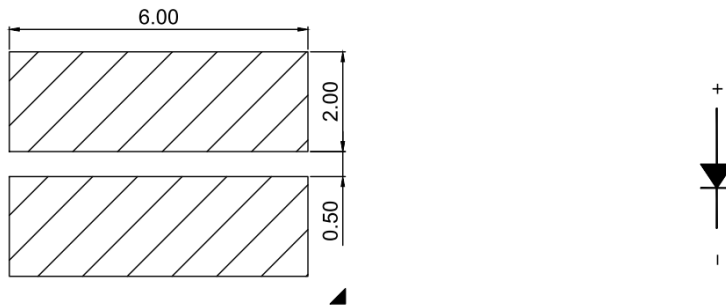

Reflow profile

Soldering ramp-up time (Pb-FREE).

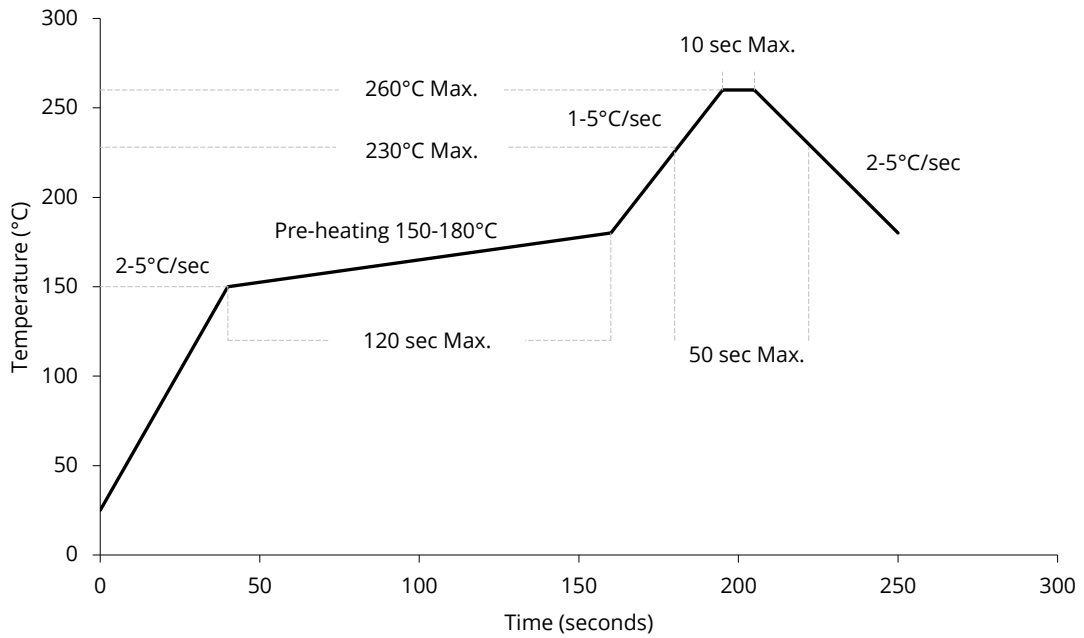

Note: Soldering paste with the melting point at 230°C is recommended.

SMT instruction

Problems caused by improper selection of collet

Choosing the right collet is important in ensuring product quality after SMT. LEDs are different from other electronic components, as they are not only concerned with electrical output but also optical output. This characteristic makes LEDs more fragile in the process of SMT. If the collet's lowering height is not well set, it will bring damage to the gold wire at the time of collet's pick-and-place process which can cause the LED to not illuminate, flicker or contribute to other quality problems, some of which may not be immediately detectable.

Collet selection

During SMT, please choose the appropriate collet in order to avoid damage the gold wire inside the LED or insufficient suction. Setting the height of the collet is crucial in order to avoid damage to the top view SMD. If the collet setting is set to too low of an altitude, the collet will press down on the SMD, causing damage or breakage to the encapsulant and cause distortion or breakage of the gold wire.

Other notes of caution

- No pressure should be exerted to the epoxy shell of the SMD under high temperature.
- Do not scratch or wipe the lens since the lens and gold wire inside are rather fragile and cross out easy to break.
- LED should be used as soon as possible when being taken out of the original package, and should be stored in anti-moisture and anti-ESD package.
- This usage and handling instructions are for reference only.

About Yujileds



Our story - Start from the superior stable red LED phosphor.

We started to make LED phosphor materials in 2006. White LEDs were still in very early stage, the industry focused on improving device brightness and efficiency via yellow phosphor very much. No one cared about the light quality. Based on this situation, we took a different approach and focused on red phosphor technology, which is the most important phosphor recipe for high CRI and/or low CCT LEDs, and it made Yuji become a JV partner with Mitsubishi Chemical from 2012.

Today, we are well known for our comprehensive research and full line-up production of LED phosphor from ultra-violet to near-infrared, and we are proud to commit to providing superior stable and efficient phosphors to the worldwide markets.

Our technology - Focus on LED spectrum innovation.

The industrial structure of both phosphor and LED gives us a unique view to develop our spectrum recipes. Compared to the general LED manufacturers, we have comprehensive information in evaluating the feasibility for both technical and commercial aspects. LED spectrum technology is not only about the quality of white LEDs, but also for different applications which have specialized requirements in lighting.

Yuji is one of the few companies that provide the service of designing or customizing a specific spectrum for clients, our confidence comes from the years of accumulation in focusing on the spectrum technologies and the control of LED phosphor and LED die supply-chain with thousands of successful cases in the past years. Innovating LED technologies and giving them commercial values are our eternal driving forces.

Our product - Yujileds®, stands for high-performance LED.

The trademark of Yujileds® is the identification of the LED products developed and manufactured by Yuji. We put our understanding of the LED technologies and the standard of our quality control into every LED we make. Regardless of any product series, we pay attention to expressing the high-performance feature and achieving the product value for clients and never compromise in pursuing the true performance.

Furthermore, we also care about every detail of any documentation we prepare for the product because we

understand the importance to transmit accurate information to clients. It is even more critical for clients to obtain the truth to decide the solution, rather than just a nominal high-performance.

Our client - Outstanding game players in different fields.

Clients are our proudest achievements, now over 200 of our clients are the best game players in their fields in more than 33 countries. We regard the clients' successes as our biggest accomplishments and appreciate their contribution in different fields, clients use our LEDs not just for simple lighting, but to design the lighting for plants, cameras, sensors, health, circadian rhythm, animals, and other industries that we have never imagined that our technologies can be utilized, that makes our work so meaningful.

Our service - Professional supporting team.

There is a group of people in Yuji passionate about creating maximum value for our clients. We have accumulated experience in different projects. Currently, the company gathers more than 30 experts from various fields of semiconductor, chemistry, optics, photoelectricity, circuitry, materials and color science.

Our sales team is well trained in deep LED technologies and has skilled global communication experience. Not just for sales, our team is more like a specialized consultancy to help every client succeed in different projects, and we do not only provide professional business service, but also support in the supply chain, logistics, marketing and technical discussions.

Contact us - We look forward to providing our efficient service for you.

LED website: www.yujiintl.com

Find Yujileds® high-performance LEDs, read our insights into a variety of advanced technologies and applications.

Contact: info@yujigroup.com

LED lighting website: www.yujilighting.com

Find our state-of-art LED lamps and luminaires designed for improving the lighting experience with the vision of illuminating the future.

Contact: lighting@yujigroup.com

Online shop: store.yujiintl.com

Shop your favorite Yuji Lighting product with rapid and professional service.

Contact: webstore@yujigroup.com