



# YJ-APS-2835HC-G01

Surface Mount Device

StandardWhite



## Applications

- High-end architectural lighting
- Healthy lighting
- Photoelectric device and relevant research

## Features

- 99% similarity to the sunlight spectrum
- Industrial high CRI performance
- 2.8mm × 3.5mm universal package
- TLCI & TM-30 specified
- SimpleBinning solution
- Lifespan > 54000 hours (IES LM80)

[About Yujileads<sup>®</sup>](#)

Rev Version: 2.1

P3220024.00

---

## Table of Contents

General description .....	3
Ordering information .....	8
Characteristics .....	9
Chromaticity group and diagram .....	11
Reliability .....	12
Package material and dimension .....	13
Characteristic graph .....	14
Solder and reflow profile .....	21
SMT instruction .....	22
Tape and reel specifications .....	23
Box packaging .....	25
About Yujileds .....	26

## General description

The APS series LED is designed for creating a new era of natural lighting spectrum LED with superb color rendering performance. Improving the artificial lighting as close to the sunlight is the eternal pursuit for the top LED manufacturers. However, the artificial lighting gets far away from the naturalness after the incandescent and halogen because the illumination principles of the later artificial lights are far away from the blackbody radiation, including LED.

The sun essentially provides complete and homogenous spectral radiation in the visual wavelengths, while an LED is always combined by the blue or purple semiconductor die with blue/green/amber/red phosphors, in consequence, it is visualized to observe that from an LED spectrum, peaks and gaps always exist because of the respective characteristics of the die and phosphors, which can not be avoided generally.

### 99% similarity to the sunlight spectrum

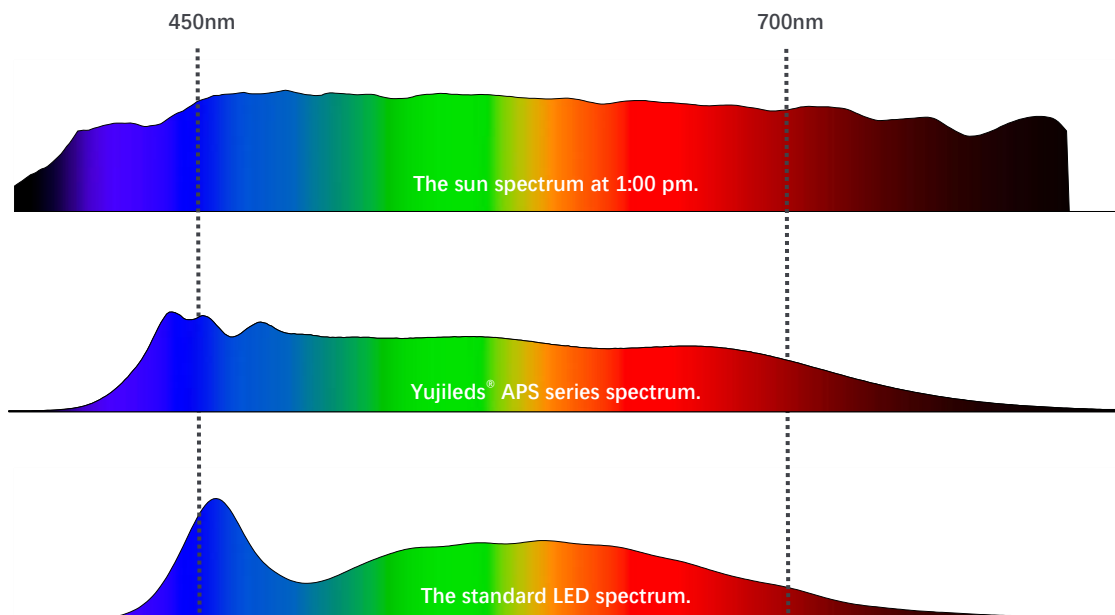

Yujileds® APS series LED is based on innovative and revolutionary technologies. It provides an unprecedented spectrum with ultra-homogeneous features within one compact package, where the color rendition performs superbly and stably. Compared to these standards, the APS spectra achieve 99% similarity within one compact package, unprecedented for all of the Yujileds® high CRI LEDs ever.

Compared to other sun spectrum LED solutions, the APS series LED utilizes the die and phosphor technologies effectively that achieves full-spectrum coverage in visual

wavelengths, which improves the luminous efficacy (lm/W) and maintenance to a great extent.

**Refuse any peaks or gaps**

Ideal illuminants always present completely uniform spectral power distributions, such as sunlight where a recent artificial light source can never simulate to a promising degree, especially for LED considering its particular illuminating principle. With the latest technology of Yujileds® phosphor and package, it is finally available to achieve homogeneous spectra and there is no longer a strong peak or obvious gap like a standard LED.

**Ri up to 100, steadily**

Yujileds® APS series LED is equally top level under CRI metric system. Achieving up to 99, R1-R15 all above 90 or even 100, the APS series LED performs steadily in color rendition, which helps with reducing the concerns of the imperfection when rendering specific colors. Even for the always mentioned contradiction between R9 and R12 is well solved in the APS series LED.

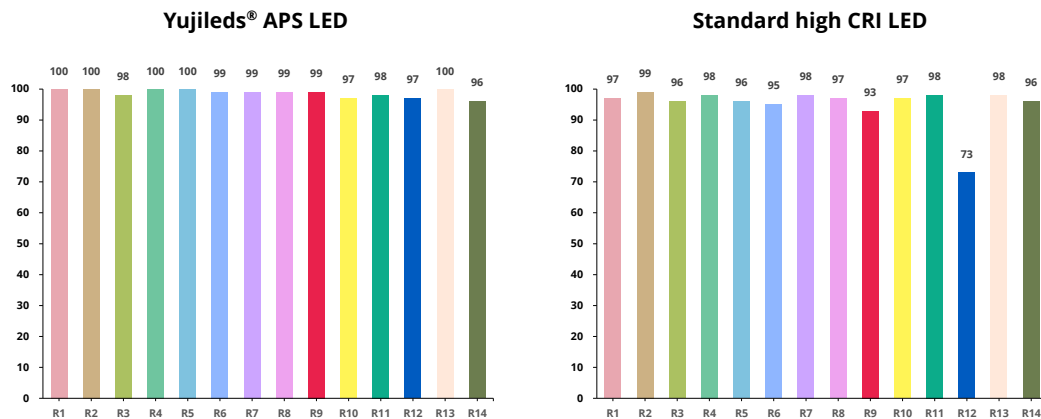

**Superlative performance in TM-30 metric valuation**

TM-30 is widely recognized as the new and more comprehensive metric to evaluate the color rendition of the LED light source, it provides more references including color fidelity and gamut from 99 evaluation samples, which means, compared to conventional metrics, the TM-30 will disclose more details to present the most authentic performance on color rendition.

The APS series TM-30 measurements are the most intuitive testifications. Given the Rf 98 Rg 100, and the average of all 99 color fidelities above 95, each color fidelity is more than 90. These values mean that Yujileds® APS series technology wins the highest level on the

color rendition, not only for individual metrics but is stable quality.

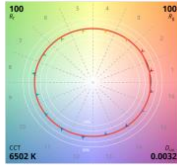
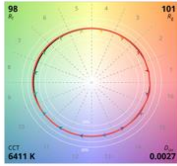
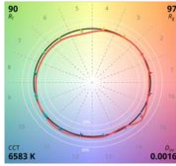
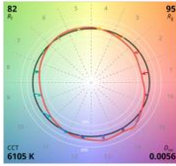
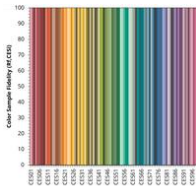
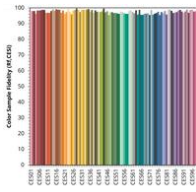
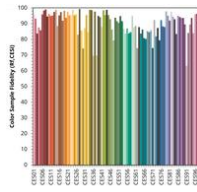
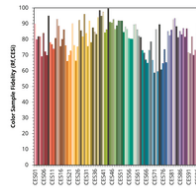
	Natural light	Yujileds® APS LED	Standard high CRI LED	Standard LED
<b>Fidelity index (Rf)</b>	100	98	90	82
<b>Gamut index (Rg)</b>	100	100	97	95
<b>Fidelity of 99 CES</b>	All = 100	All > 90	Average 90	Average 82
<b>Color Vector Graphic (CVG)</b>				
<b>Color Sample Fidelity</b>				

**Specialized StandardWhite binning**

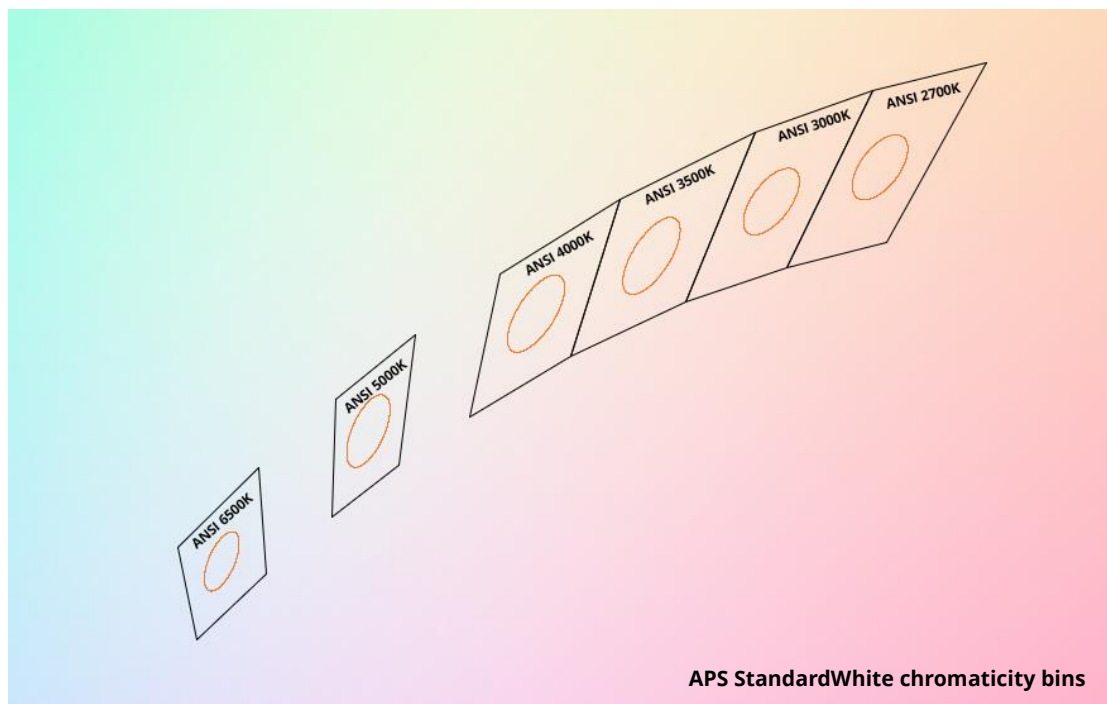

In order to provide highly consistent chromaticities, Yujileds® offers ANSI 3-step bin, and with SimpleBinning technologies based on Yujileds® module, the lighting design is simplified greatly but no compromise on color quality, the equivalent consistency can be expected to 2-step SDCM.

**The first choice for high-performance LED**

The revolutionary meaning of Yujileds® APS series LED is not only about its remarkable spectrum quality, but is the balanced achievement of cost, efficacy, maintenance and color rendering. Compared to competitors' LED, the APS series LED is more friendly for commercialization in different applications.

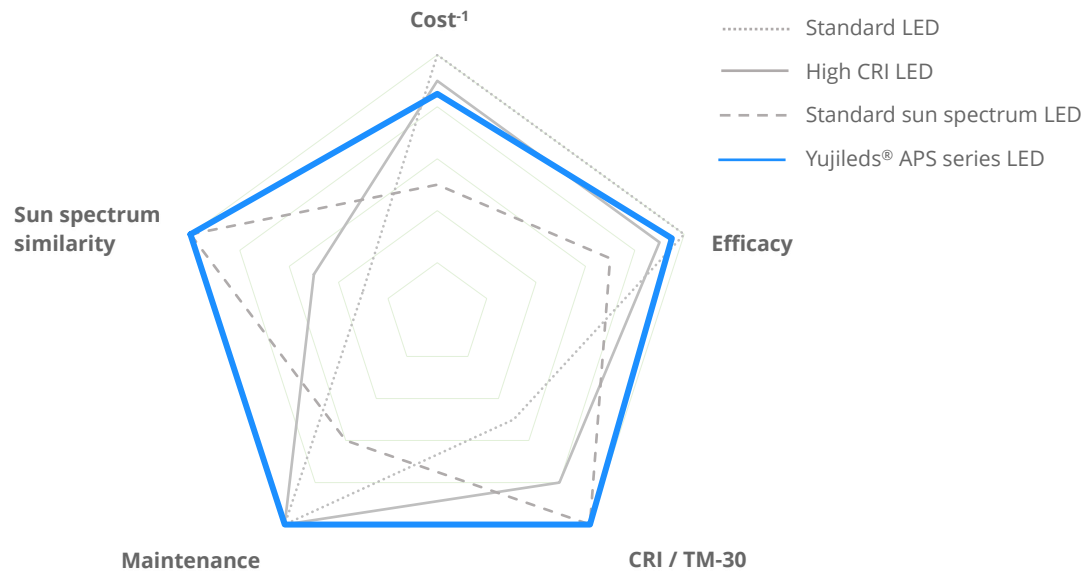

The APS series LED also supports the unique service/certification by Yujileds® as described below.



**TM-30-18 specification**

The most advanced colorimetric for color rendition, widely recognized as the successor of CRI.

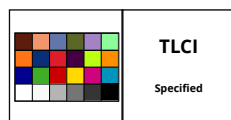

**TLCI specification**

Based on the Macbeth ColorChecker, for evaluating the colorimetric quality of the broadcast lighting.



**IESNA LM-80-08 certification**

9000 hours data of chromaticity shift and TM-21 reported L70 lifetime at 55°C, 85°C and 105°C.

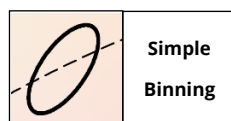

**SimpleBinning specification**

Simplify the chromaticity binning with TrueChroma data support to provide the most economical, simple, and practical solution to customers.

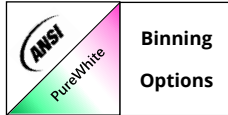
**Binning options for Standard or PureWhite**

Besides the industrial standard binning (ANSI 3-step), the optional PureWhite binning can provide balanced and precise white colors.

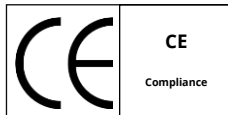
**RoHS 2011/65/EU compliance****CE compliance****REACH compliance (Phosphor)**

## Ordering information

PART NUMBER	PRODUCT CODE	CCT	CHROMATICITY BINS	VOLTAGE RANGE
<b>YJ-APS-2835HC-G01-27</b>	P3220024.27	2700K	27A	0.2V
<b>YJ-APS-2835HC-G01-30</b>	P3220024.30	3000K	30A	0.2V
<b>YJ-APS-2835HC-G01-35</b>	P3220024.35	3500K	35A	0.2V
<b>YJ-APS-2835HC-G01-40</b>	P3220024.40	4000K	40A	0.2V
<b>YJ-APS-2835HC-G01-50</b>	P3220024.50	5000K	50A	0.2V
<b>YJ-APS-2835HC-G01-65</b>	P3220024.65	6500K	65A	0.2V
<b>YJ-APS-2835HC-G01-XX</b>	P3220024.xx	Custom CCT	-	0.2V



## Characteristics

Electrical-optical characteristics ( $T_A = 25^\circ\text{C}$ , 100mA)

PARAMETER	SYMBOL	VALUE			UNIT	TOLERANCE
		MIN.	TYP.	MAX.		
<b>Forward voltage</b>	$V_F$	8.6	-	9.2	V	$\pm 0.05$
<b>Luminous flux</b>	$\Phi_{2700K}$	95	-	105	lm	-
	$\Phi_{3000K}$	103	-	113		
	$\Phi_{3500K}$	105	-	115		
	$\Phi_{4000K}$	108	-	118		
	$\Phi_{5000K}$	113	-	123		
	$\Phi_{6500K}$	110	-	120		
<b>Correlated color temperature<sup>(1)</sup></b>	$CCT_{2700K}$	-	2700	-	K	-
	$CCT_{3000K}$	-	3000	-		
	$CCT_{3500K}$	-	3500	-		
	$CCT_{4000K}$	-	4000	-		
	$CCT_{5000K}$	-	5000	-		
	$CCT_{6500K}$	-	6500	-		
<b>Color rendering index</b>	$R_a$	97 <sup>(2)</sup>	-	-	-	$\pm 1$
	$R_i$ (i = 1-15)	90	-	-	-	-
<b>Fidelity index<sup>(3)</sup></b>	$R_f$	-	98	-	-	-
<b>Gamut index<sup>(3)</sup></b>	$R_g$	-	100	-	-	-
<b>TLCI 2012<sup>(4)</sup></b>	-	-	99	-	-	-
<b>Reverse current</b>	$I_r$	-	-	10	$\mu\text{A}$	$\pm 0.1$ ( $V_r = 15\text{V}$ )
<b>View angle</b>	$2\theta_{1/2}$	-	120	-	Deg	$\pm 5$
<b>Thermal resistance</b>	$R_{\theta JS}$	-	15 <sup>(5)</sup>	-	$^\circ\text{C/W}$	-

(1). Yujileds® promises the chromaticity coordinate tolerance of  $\pm 0.0015$  (CIE 1931 x,y) based on Yuji standard equipment shall prevail.

(2).  $R_a$  minimum 96 at 6500K.

(3). Defined by the IES TM-30-18 method, this data is for trial.

(4). Defined by the EBU, TLCI is the abbreviation of Television Lighting Consistency Index, this data is for trial.

(5). This data is for reference only.

## Characteristics

Absolute maximum ratings ( $T_A = 25^\circ\text{C}$ )

PARAMETER	SYMBOL	LIMIT	UNIT
<b>Power Consumption</b>	$P_D$	1200	mW
<b>DC Forward Current (pulsed)<sup>(1)</sup></b>	$I_{FP}$	150 <sup>(2)</sup>	mA
<b>DC Forward Current</b>	$I_F$	120	mA
<b>Reverse Voltage</b>	$V_R$	15	V
<b>Junction Temperature</b>	$T_j$	125	$^\circ\text{C}$
<b>Solder Point Temperature<sup>(3)</sup></b>	$T_s$	105	$^\circ\text{C}$
<b>Operating Temperature</b>	$T_{opr}$	-40 ~ +85	$^\circ\text{C}$
<b>Storage Temperature</b>	$T_{stg}$	-30 ~ +85	$^\circ\text{C}$
<b>Soldering Temperature</b>	$T_{sol}$	260 $\pm$ 5	$^\circ\text{C}$
<b>Reflow Cycles Allowed</b>	-	2	-

(1). Pulse width  $\leq 0.1\text{ms}$ , duty  $\leq 1/10$ .

(2). Theoretical data.

(3). See page [Package material and dimension](#).

## Chromaticity group and diagram

### Chromaticity bins & coordinates

CCT	BIN	CIE 1931 COORDINATES						SDCM	Refer to CCT
		X	Y	a	b	$\theta$			
<b>2700K</b>	27A	0.4578	0.4101	0.00810	0.00420	49.70	3	2650 - 2800 K	
<b>3000K</b>	30A	0.4338	0.4030	0.00834	0.00408	50.22	3	2950 - 3150 K	
<b>3500K</b>	35A	0.4073	0.3917	0.00939	0.00402	54.80	3	3350 - 3600 K	
<b>4000K</b>	40A	0.3818	0.3797	0.00939	0.00402	54.80	3	3850 - 4150 K	
<b>5000K</b>	50A	0.3447	0.3553	0.00822	0.00354	64.12	3	4850 - 5200 K	
<b>6500K</b>	65A	0.3123	0.3282	0.00669	0.00285	64.57	3	6300 - 6800 K	

### CIE 1931 diagram

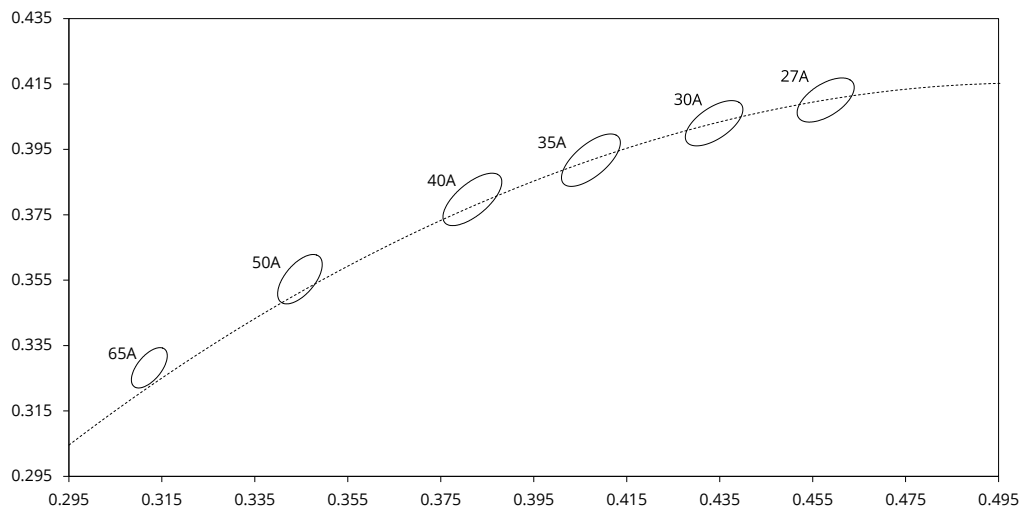

Reliability<sup>(1)</sup>

$T_s = 55^\circ\text{C}$ ,  $I_F = 100\text{mA}$ ,  $\text{RH} < 65\%$ , reported  $L70 > 54000$  hours<sup>(2)</sup>

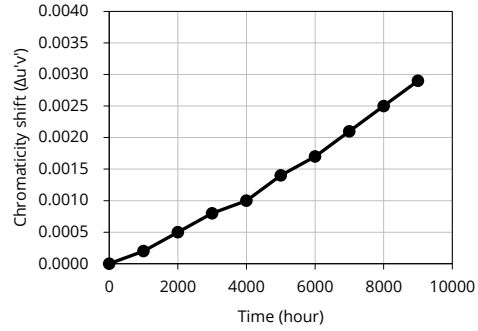
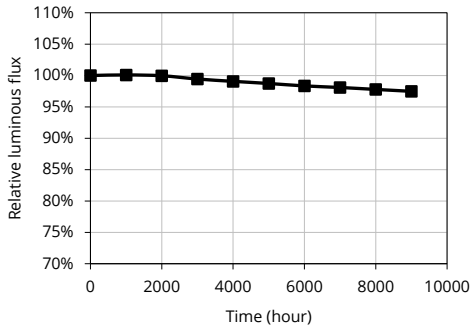

$T_s = 85^\circ\text{C}$ ,  $I_F = 100\text{mA}$ ,  $\text{RH} < 65\%$ , reported  $L70 > 54000$  hours<sup>(2)</sup>

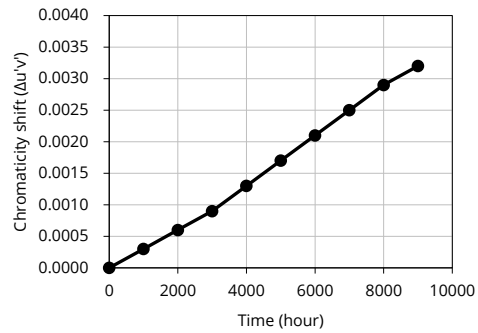
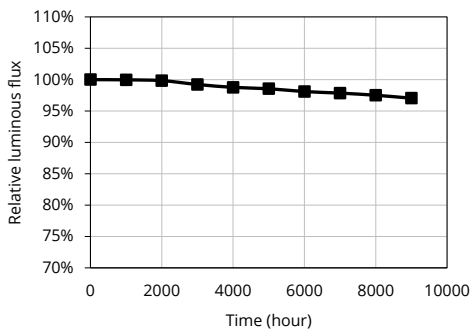

$T_s = 105^\circ\text{C}$ ,  $I_F = 100\text{mA}$ ,  $\text{RH} < 65\%$ , reported  $L70 > 54000$  hours<sup>(2)</sup>

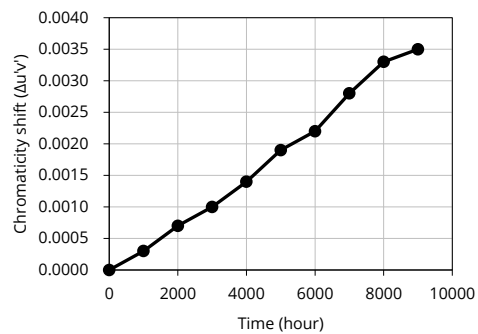
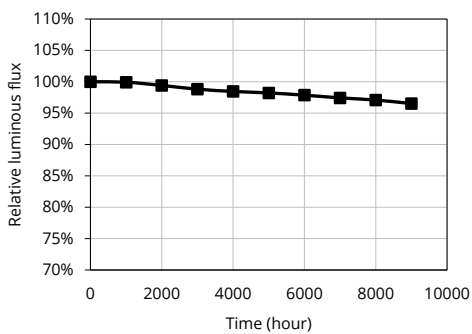

(1). Data from IESNA LM-80-2008, report number LCS210701156BS.

(2). Yujileds® reserves all the right for final explanation of reliability.

## Package material and dimension

### Package layout

All dimensions in mm, tolerance unless mentioned is  $\pm 0.1$ mm.

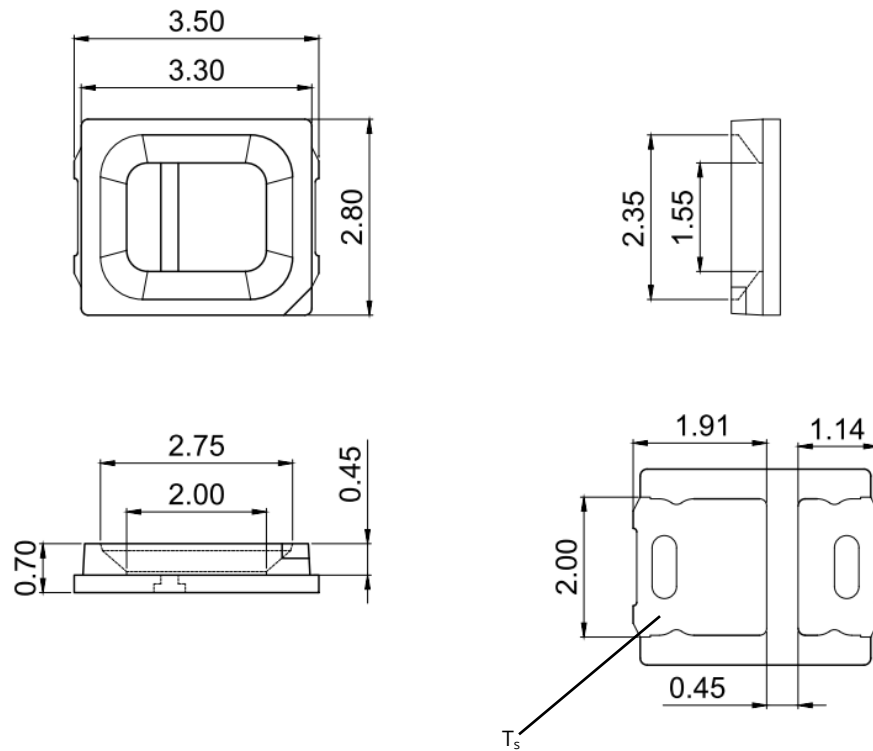

### Package materials

ITEM	DESCRIPTION
Die material	InGaN
Lead frame material	PCT
Encapsulant resin material	Silicon + Phosphor
Electrodes material	Silver-plated copper

## Characteristic graph

### Typical spectral power distribution (normalized)

All characteristic curves are for reference only and not guaranteed.

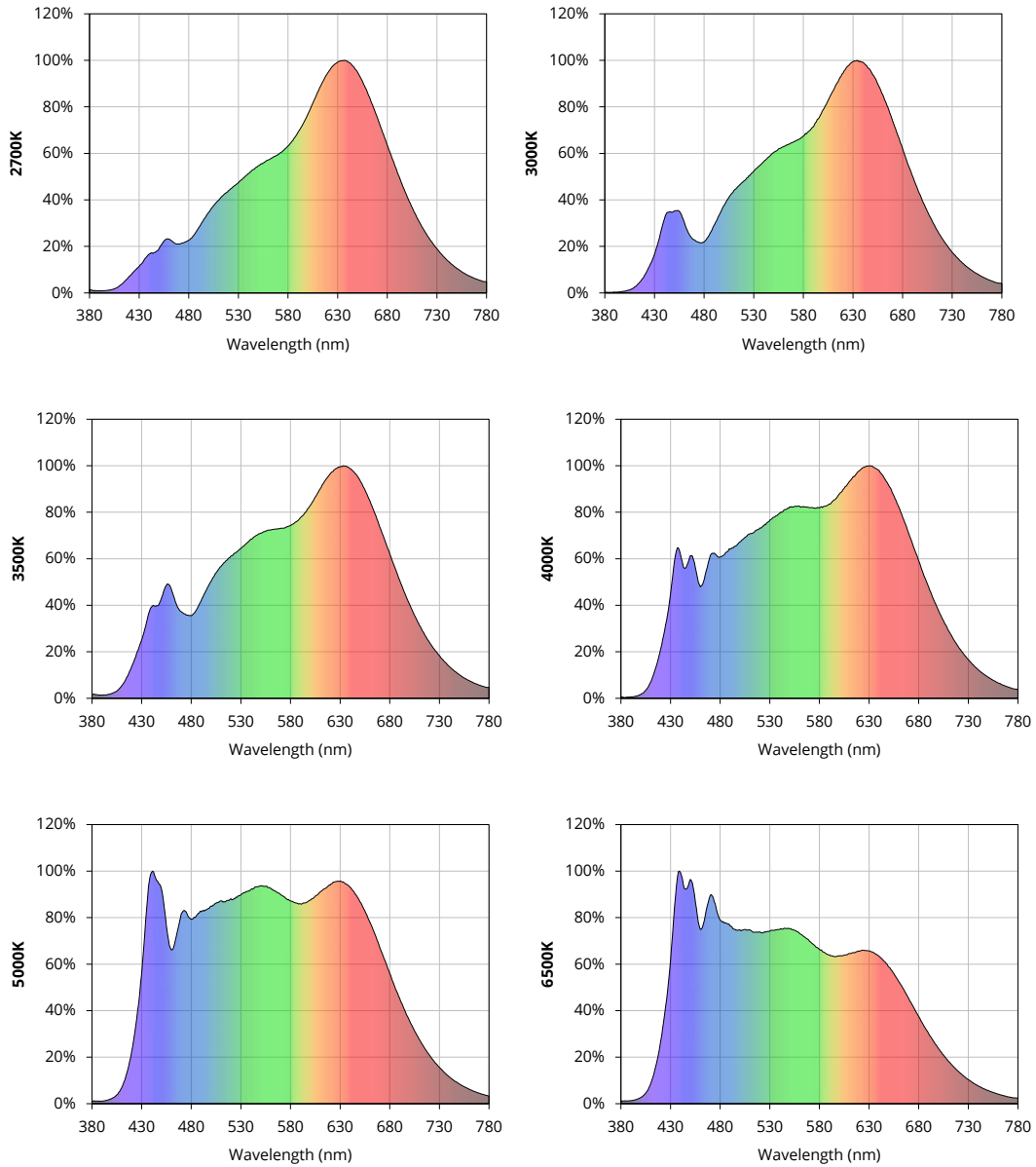

## Characteristic graph

### Forward current

All characteristic curves are for reference only and not guaranteed.

Vs. forward voltage

(T<sub>A</sub> = 25°C)

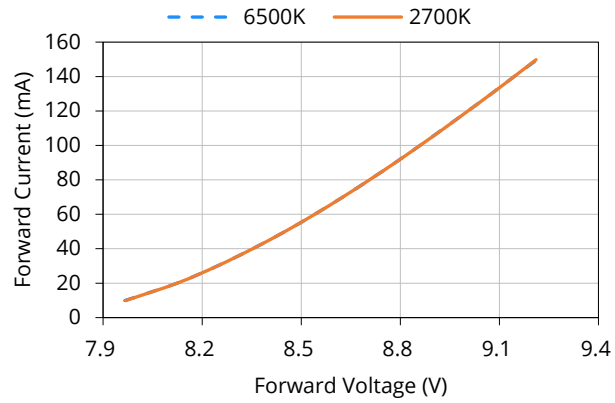

Vs. relative luminous flux

(T<sub>A</sub> = 25°C)

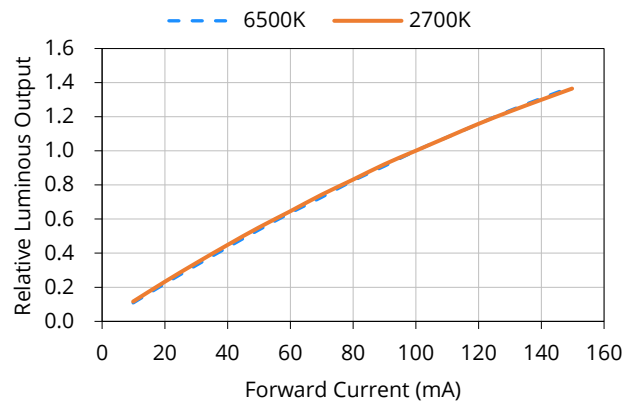

## Characteristic graph

### Forward current (continued)

All characteristic curves are for reference only and not guaranteed.

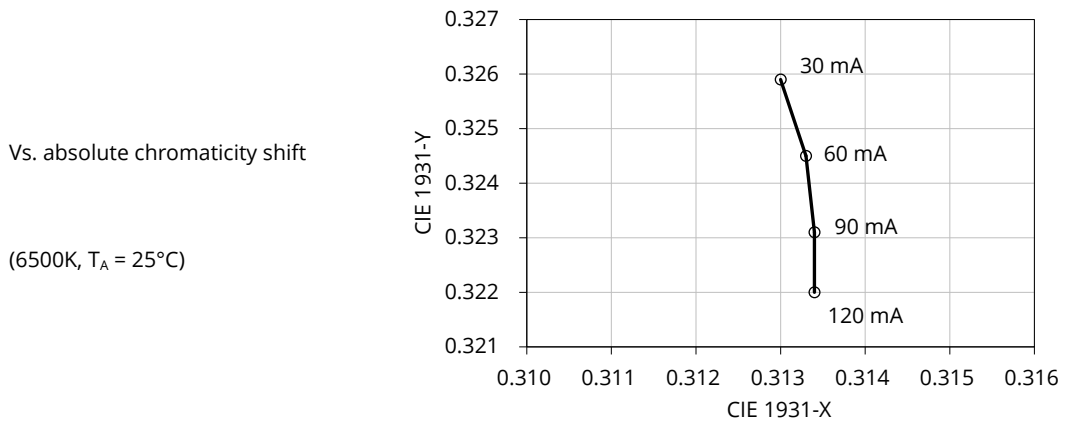
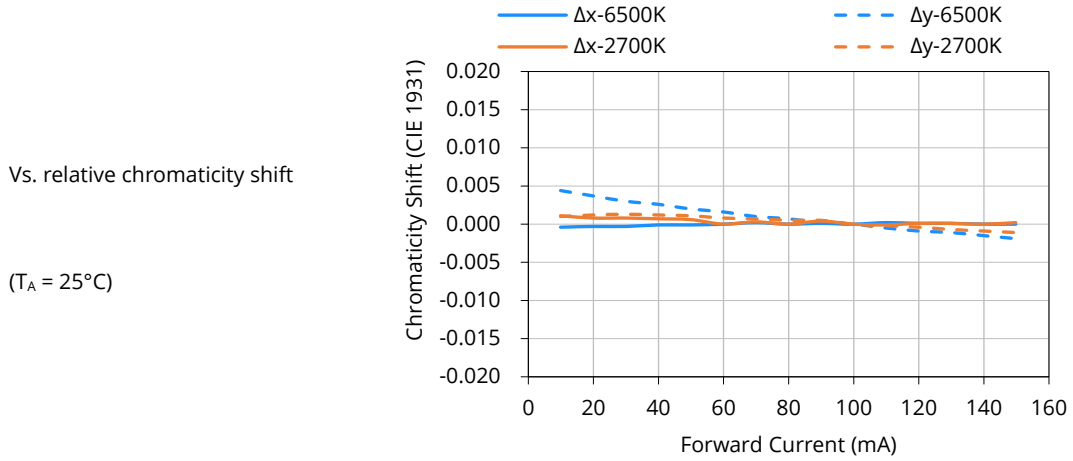



## Characteristic graph

### Forward current (continued)

All characteristic curves are for reference only and not guaranteed.

#### Derating based on solder point

Note: De-rating curves are meant for recommendation only and are not meant to provide guarantees of product stability and longevity.

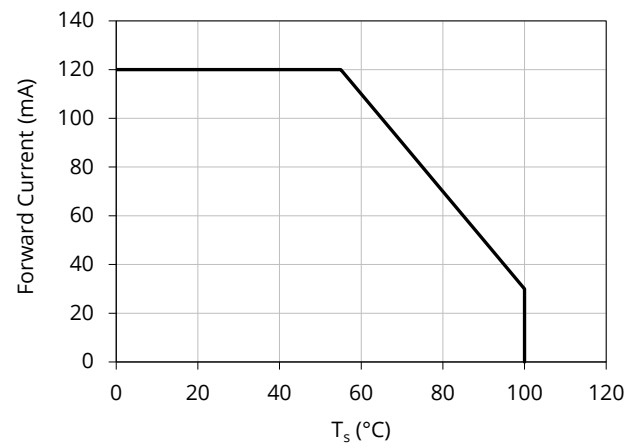

## Characteristic graph

### Solder point temperature ( $T_s$ )

All characteristic curves are for reference only and not guaranteed.

Vs. forward voltage

( $I_F = 100\text{mA}$ )

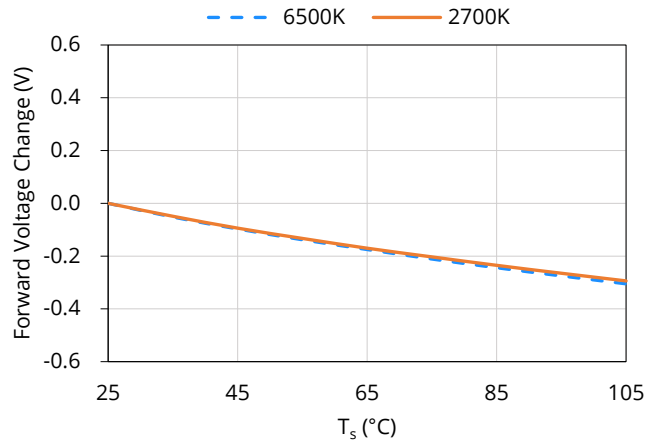

Vs. relative luminous flux

( $I_F = 100\text{mA}$ )

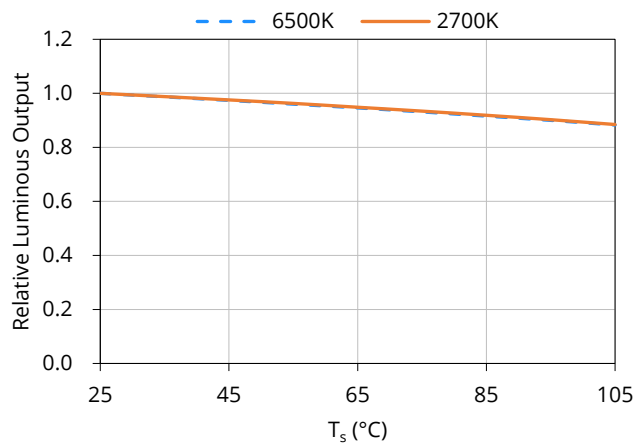

## Characteristic graph

### Solder point temperature ( $T_s$ ) (continued)

All characteristic curves are for reference only and not guaranteed

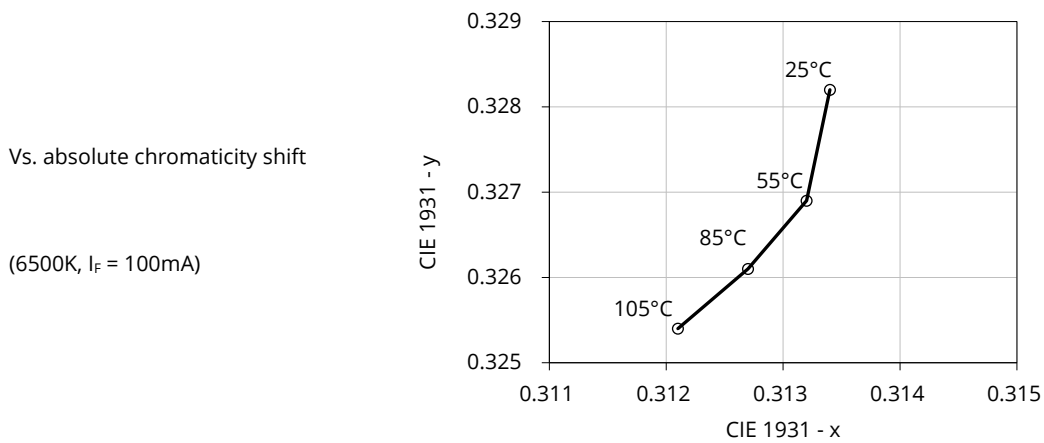
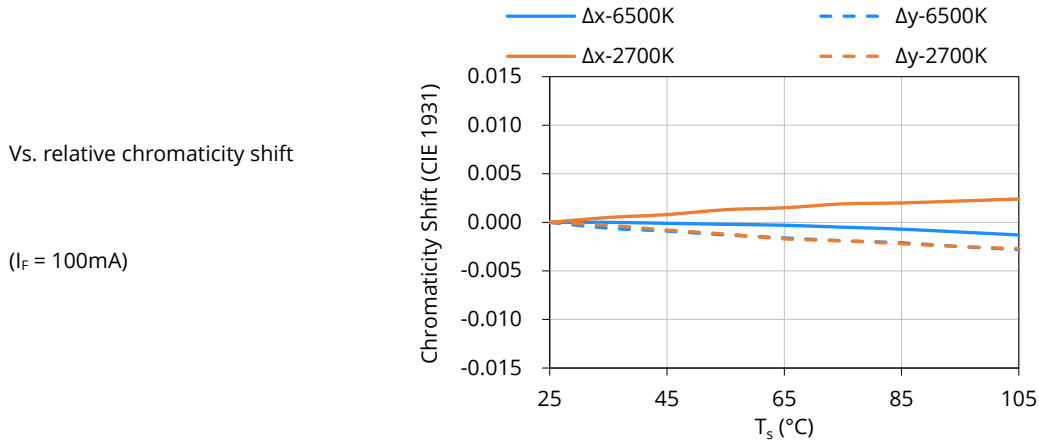

## Characteristic graph

Spatial distribution ( $T_A = 25^\circ\text{C}$ ,  $I_F = 100\text{ mA}$ )

All characteristic curves are for reference only and not guaranteed.

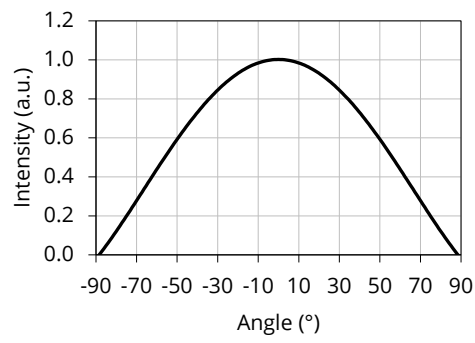

## Solder and reflow profile

### Recommended solder pad layout

All dimensions in mm, tolerance unless mentioned is  $\pm 0.1$ mm.

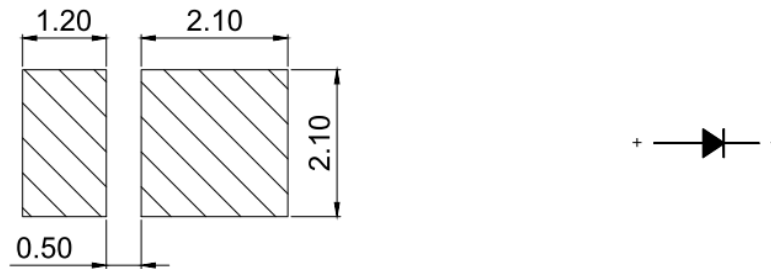

### Reflow profile

Soldering ramp-up time (Pb-FREE).

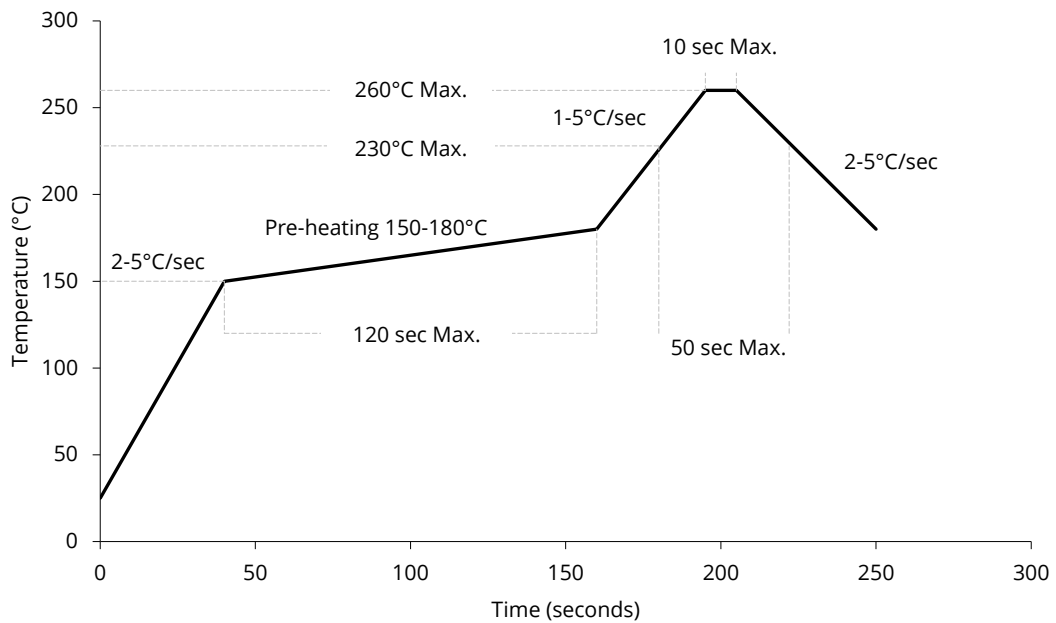

Note: Soldering paste with the melting point at 230°C is recommended.

---

## SMT instruction

### Problems caused by improper selection of collet

Choosing the right collet is important in ensuring product quality after SMT. LEDs are different from other electronic components, as they are not only concerned with electrical output but also optical output. This characteristic makes LEDs more fragile in the process of SMT. If the collet's lowering height is not well set, it will bring damage to the gold wire at the time of collet's pick-and-place process which can cause the LED to not illuminate, flicker or contribute to other quality problems, some of which may not be immediately detectable.

### Collet selection

During SMT, please choose the appropriate collet in order to avoid damage the gold wire inside the LED or insufficient suction. Setting the height of the collet is crucial in order to avoid damage to the top view SMD. If the collet setting is set to too low of an altitude, the collet will press down on the SMD, causing damage or breakage to the encapsulant and cause distortion or breakage of the gold wire.

### Other notes of caution

- No pressure should be exerted to the epoxy shell of the SMD under high temperature.
- Do not scratch or wipe the lens since the lens and gold wire inside are rather fragile and cross out easy to break.
- LED should be used as soon as possible when being taken out of the original package, and should be stored in anti-moisture and anti-ESD package.
- This usage and handling instructions are for reference only.

## Tape and reel specifications

Tape dimensions (unit: mm)

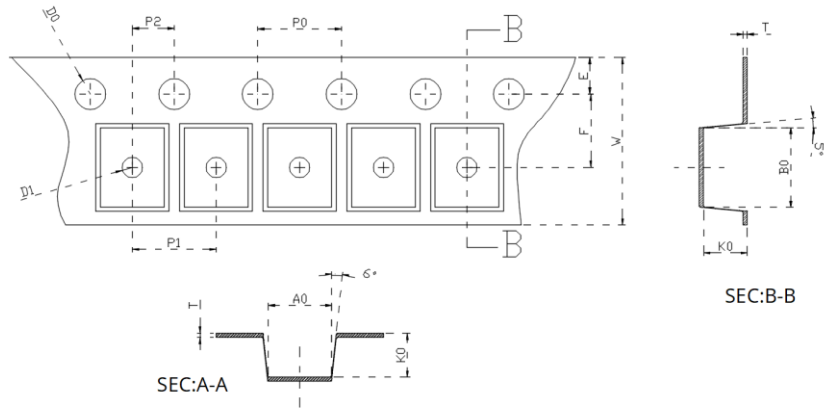

<b>Code</b>	W	T	D1	E	F	D0
<b>Value</b>	8.000	0.180	1.000	1.750	3.500	1.600
<b>Tolerance</b>	$\pm 0.100$	$\pm 0.020$	$\pm 0.100$	$\pm 0.100$	$\pm 0.100$	$\pm 0.100$
<b>Code</b>	P0	P1	P2	A0	B0	K0
<b>Value</b>	4.000	4.000	2.000	3.250	3.400	0.850
<b>Tolerance</b>	$\pm 0.100$	$\pm 0.100$	$\pm 0.100$	$\pm 0.100$	$\pm 0.100$	$\pm 0.100$

## Tape layout

Not drawn to scale.

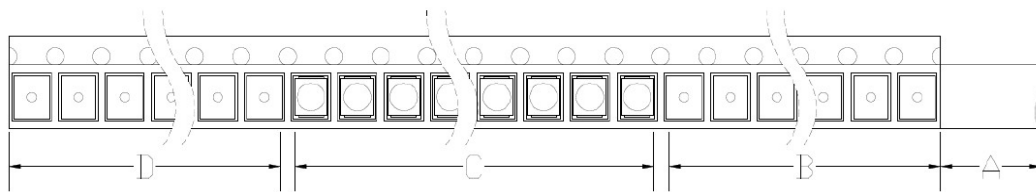

- A: Cover tape, 300mm;
- B: Empty leader, 200mm;
- C: LED, 4000pcs;
- D: Empty trailer, 200mm.

## Tape and reel specifications

Reel dimensions top (unit: mm)

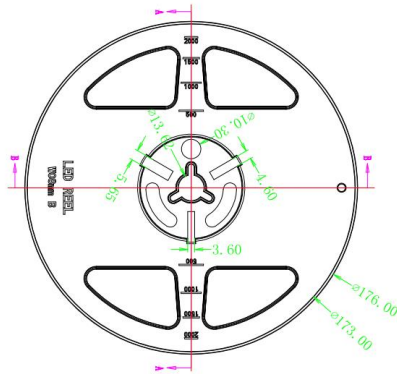

Reel dimensions bottom (unit: mm)

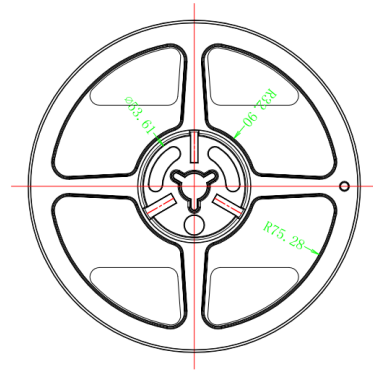

Reel dimensions side (unit: mm)

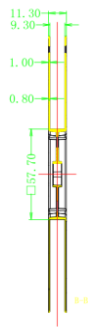

Feeding direction

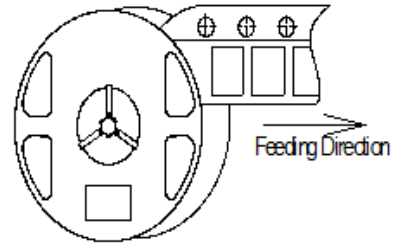



## Box packaging

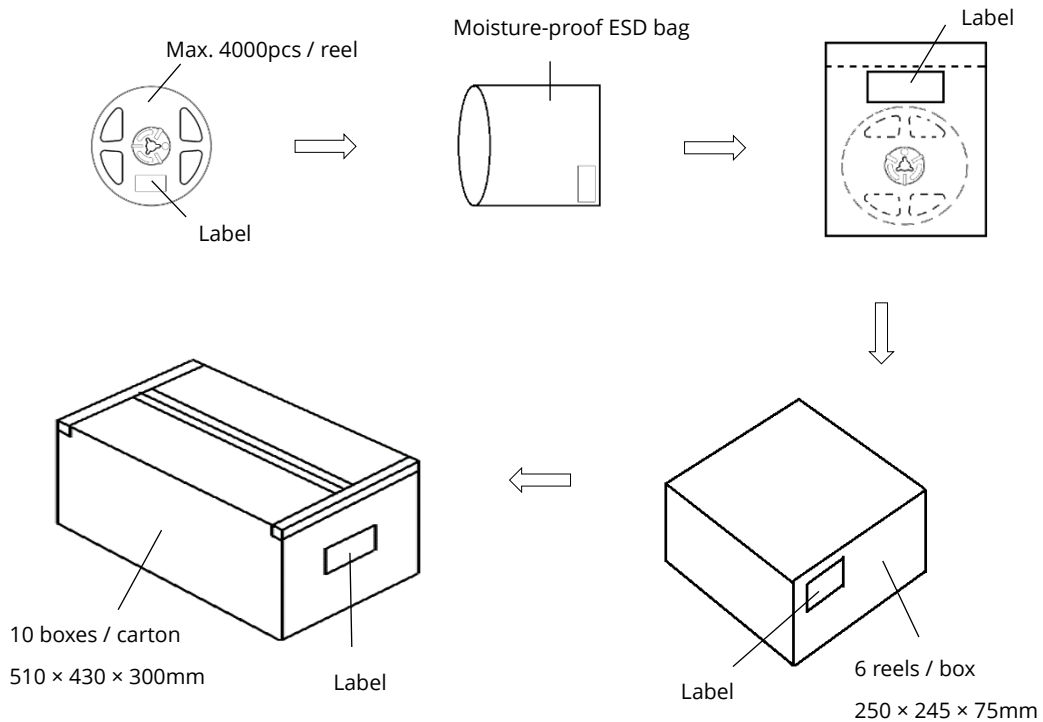

- Reeled products (max 4000pcs / reel) are packed in a moisture-proof bag along with a moisture desiccant pack.
- Each inner box contains up to 6 moisture-proof bag (total maximum number of SMDs is 30000pcs). Box package size: 250 mm × 245 mm × 75 mm.
- Each outer package contains 10 inner boxes. Box size: 510 mm × 430 mm × 300 mm.
- Outer package is sealed with protective bubble wrap and foam. (Part numbers, lot numbers, quantity should appear on the label on the moisture-proof bag, part numbers).
- This packaging merely intended as a reference for standard quantity orders only – please note that actual packaging can differ depending on the order circumstances.

## About Yujileds



**Our story** - Start from the superior stable red LED phosphor.

We started to make LED phosphor materials in 2006. White LEDs were still in very early stage, the industry focused on improving device brightness and efficiency via yellow phosphor very much. No one cared about the light quality. Based on this situation, we took a different approach and focused on red phosphor technology, which is the most important phosphor recipe for high CRI and/or low CCT LEDs, and it made Yuji become a JV partner with Mitsubishi Chemical from 2012.

Today, we are well known for our comprehensive research and full line-up production of LED phosphor from ultra-violet to near-infrared, and we are proud to commit to providing superior stable and efficient phosphors to the worldwide markets.

**Our technology** - Focus on LED spectrum innovation.

The industrial structure of both phosphor and LED gives us a unique view to develop our spectrum recipes. Compared to the general LED manufacturers, we have comprehensive information in evaluating the feasibility for both technical and commercial aspects. LED spectrum technology is not only about the quality of white LEDs, but also for different applications which have specialized requirements in lighting.

Yuji is one of the few companies that provide the service of designing or customizing a specific spectrum for clients, our confidence comes from the years of accumulation in focusing on the spectrum technologies and the control of LED phosphor and LED die supply-chain with thousands of successful cases in the past years. Innovating LED technologies and giving them commercial values are our eternal driving forces.

**Our product** - Yujileds®, stands for high-performance LED.

The trademark of Yujileds® is the identification of the LED products developed and manufactured by Yuji. We put our understanding of the LED technologies and the standard of our quality control into every LED we make. Regardless of any product series, we pay attention to expressing the high-performance feature and achieving the product value for clients and never compromise in pursuing the true performance.

Furthermore, we also care about every detail of any documentation we prepare for the product because we

---

understand the importance to transmit accurate information to clients. It is even more critical for clients to obtain the truth to decide the solution, rather than just a nominal high-performance.

**Our client** - Outstanding game players in different fields.

Clients are our proudest achievements, now over 200 of our clients are the best game players in their fields in more than 33 countries. We regard the clients' successes as our biggest accomplishments and appreciate their contribution in different fields, clients use our LEDs not just for simple lighting, but to design the lighting for plants, cameras, sensors, health, circadian rhythm, animals, and other industries that we have never imagined that our technologies can be utilized, that makes our work so meaningful.

**Our service** - Professional supporting team.

There is a group of people in Yuji passionate about creating maximum value for our clients. We have accumulated experience in different projects. Currently, the company gathers more than 30 experts from various fields of semiconductor, chemistry, optics, photoelectricity, circuitry, materials and color science.

Our sales team is well trained in deep LED technologies and has skilled global communication experience. Not just for sales, our team is more like a specialized consultancy to help every client succeed in different projects, and we do not only provide professional business service, but also support in the supply chain, logistics, marketing and technical discussions.

**Contact us** - We look forward to providing our efficient service for you.

**LED website:** [www.yujiintl.com](http://www.yujiintl.com)

Find Yujileds® high-performance LEDs, read our insights into a variety of advanced technologies and applications.

Contact: [info@yujigroup.com](mailto:info@yujigroup.com)

**LED lighting website:** [www.yujilighting.com](http://www.yujilighting.com)

Find our state-of-art LED lamps and luminaires designed for improving the lighting experience with the vision of illuminating the future.

Contact: [lighting@yujigroup.com](mailto:lighting@yujigroup.com)

**Online shop:** [store.yujiintl.com](http://store.yujiintl.com)

Shop your favorite Yuji Lighting product with rapid and professional service.

Contact: [webstore@yujigroup.com](mailto:webstore@yujigroup.com)