



YJ-VTC-2835X-G02

Surface Mount Device

Applications

- High-end architectural lighting
- Horticulture lighting
- Photographic/broadcast lighting
- Human-centric lighting
- Photoelectric device and relevant research



Features

- Full spectrum
- Industrial highest CRI performance
- 2.8mm × 3.5mm universal package
- TLCI & TM-30 specified
- Exempt Risk Group certified (IEC 62471)
- SimpleBinning solution

[About Yujileds[®]](#)

Document Number: YJWJ075

Rev Version: 2.0

P3190001.00

Table of Contents

General description	3
Ordering information	8
Characteristics	9
Electrical-optical characteristics.....	9
Absolute maximum ratings	10
Chromaticity group and diagram	11
Chromaticity bins & coordinates	11
CIE 1931 diagram.....	11
Package material and dimension.....	12
Package layout.....	12
Package materials.....	12
Characteristic graph	13
Typical spectral power distribution	13
Forward current.....	14
- Vs. forward voltage	14
- Vs. relative luminous flux	14
- Vs. absolute chromaticity shift.....	15
- Derating based on solder point	15
Solder point temperature.....	16
- Vs. forward voltage	16
- Vs. relative chromaticity shift.....	16
- Vs. absolute chromaticity shift.....	16
Spatial distribution	17
Solder and reflow profile	18
Recommended solder pad layout.....	18
Reflow profile.....	18
SMT instruction	19
Problems caused by improper selection of collet.....	19
Collet selection.....	19
Other notes of caution.....	19

Tape and reel specifications 20

Box packaging 22

About Yujileds 23

General description

The sun is well recognized as the perfect light source because of its completely uniform, continuous and broad spectrum. With the development of artificial lighting technologies, efficiency is improved significantly however the illumination quality gets worse. There is no longer a light source that is like incandescent or halogen with perfect spectrum, especially when LED is invented and widely applied, while achieving unprecedented energy saving benefits, we have sacrificed the illumination quality tremendously until the Yujileds® VTC series LEDs come out.

95% spectral similarity to the sunlight

The wavelength range for human visual sensitivity is generally considered as 400nm – 700nm, for which the sun spectrum covers completely. On account of the illumination principle, a standard LED only covers 430nm – 670nm with at least 20% relative radiant power compared to the 450nm peak wavelength, therefore the purple and deep red light are missed in a standard LED, furthermore the sharp peak of the blue light has been an intractable challenge for many years.

Yujileds VTC technology succeeds in broadening the spectrum coverage to 400nm – 730nm, which is 40% more coverage than a standard LED spectrum, in addition, the VTC technology eliminates the sharp blue peaks then achieves the homogeneous spectral power distribution hence it mimics 95% similarity to the sunlight within the visible spectrum.

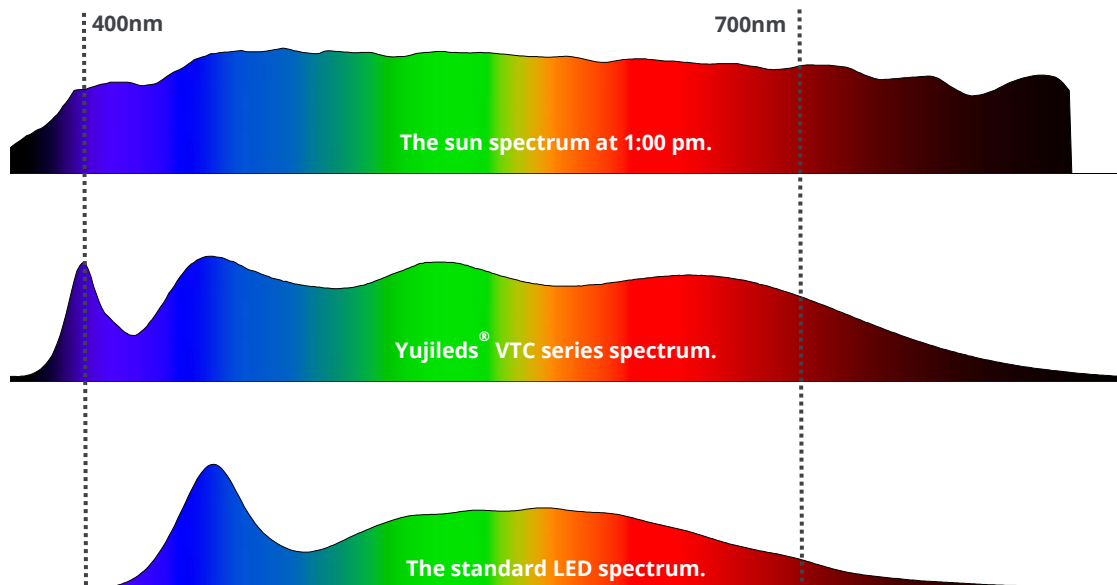

No compromise on the spectral quality

Not limited to a fixed full spectrum, the VTC technology can extend to wider CCT scopes. The spectral recipe of each CCT is well designed with Yujileds state-of-the-art LED phosphor and the well-chosen LED dies. By covering the practical solar spectra at any time all day, the illumination quality will never be compromised regardless of any CCT is selected. Eventually we can obtain a better light source than incandescent and halogen based on LED with the full flexibility of different white lights thanks to the VTC technology.

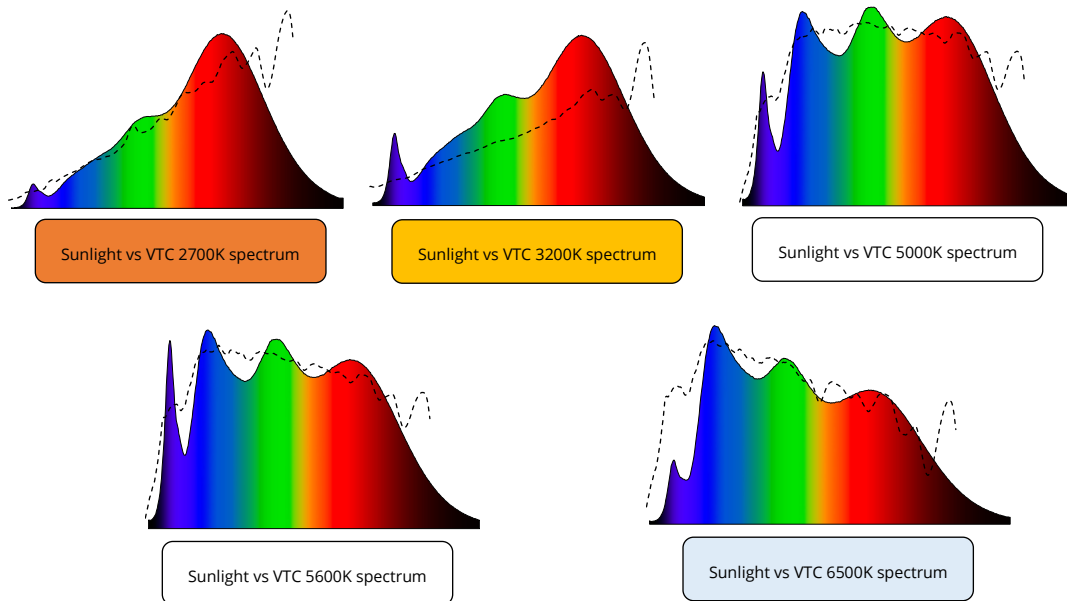

98 CRI for true color vividness

CRI (Color Rendering Index) is a most accepted colorimetric for evaluating the ability of a light source rendering the original color of an object. Benefiting from the full spectrum, the VTC series LED performs remarkable color rendition by achieving the CRI up to 98 (with minimum 95) where the full-score is 100. Comparatively, a standard 80 CRI LED which is still widely used performs less color fidelity and saturation.

Introduce the TM-30 metric for 99 color evaluation samples

The TM-30 metric is defined and proposed by the Illuminating Engineering Society (IES), aiming to provide comprehensive evaluation on color quality of new light sources especially for LED and it is released as the supplement or even replacement of CRI in the future. TM-30 utilizes 99 color evaluation samples which are selected from more than 100000 measured objects to be representative of the world of possible colors. Compared to CRI, the TM-30 is more critical on the spectral quality therefore when a standard LED has a CRI as 97, the Rf (Fidelity Index) of TM-30 is about 90, but for VTC series 99 CRI LED, the Rf is maintained as 95-97 which means the VTC technology provides extremely stable ability for rendering most of the possible colors.

Constant color rendition

Colors are not only well rendered under one specific spectrum but for all CCTs covering from the warm white to daylight. As the result of the well-designed spectral recipes, CRI values are ensured to be constant and since the VTC technology focuses on the spectral quality, likewise the TM-30 scores are maintained at high values constantly.

2700K

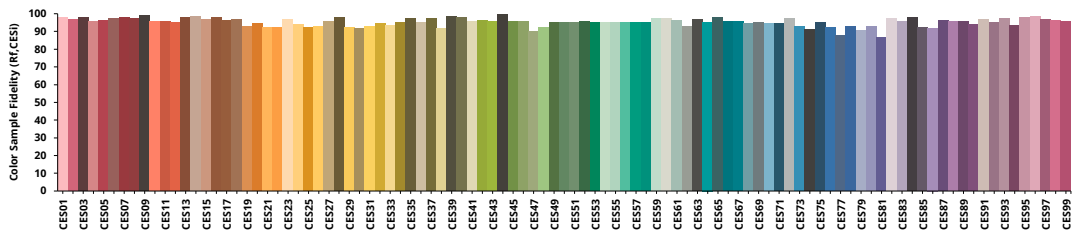
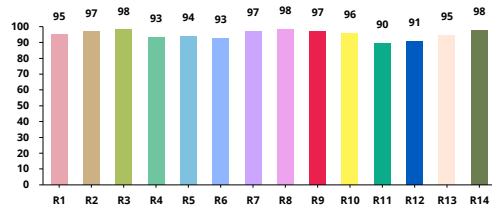

3200K

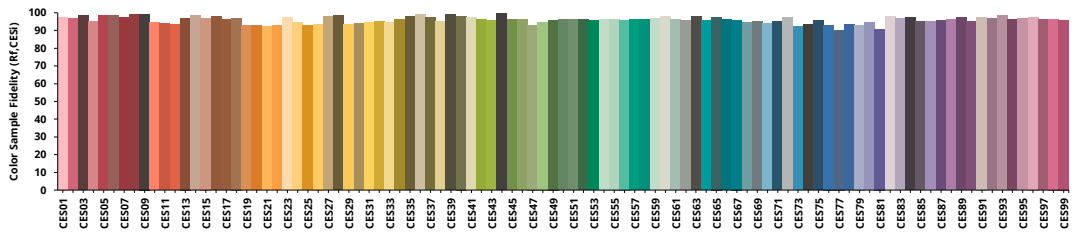
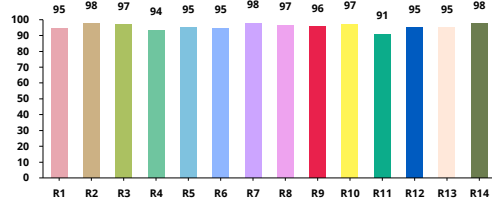

5000K

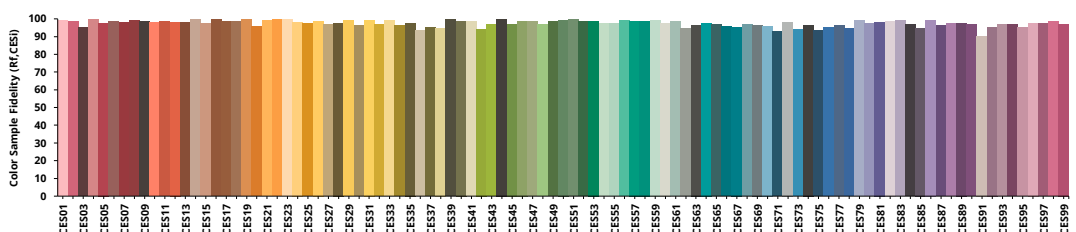
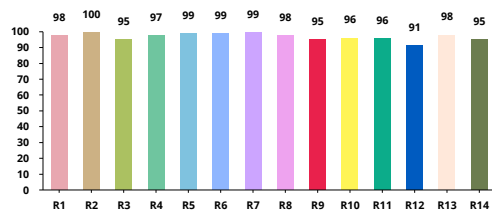

5600K

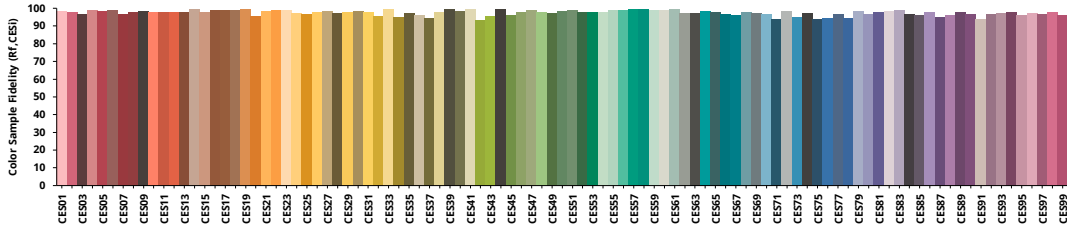
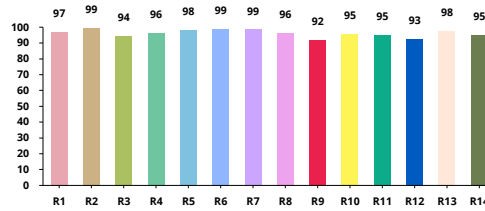

6500K

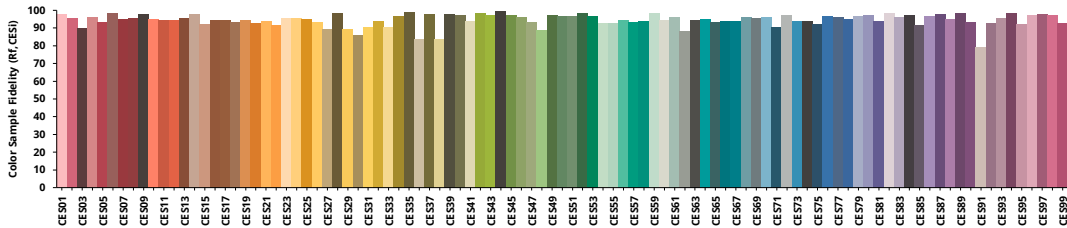
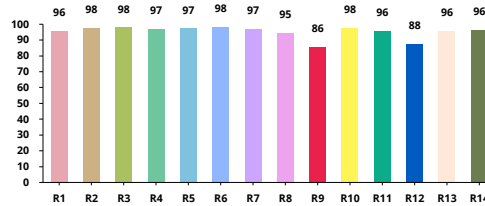

The VTC series 2835X LED also supports the unique service/certification by Yujileads® as described below.



TM-30
Specified

TM-30-18 specification

The most advanced colorimetric for color rendition, widely recognized as the successor of CRI.

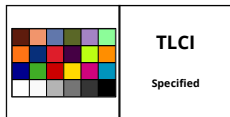

TLCI
Specified

TLCI specification

Based on the Macbeth ColorChecker, for evaluating the colorimetric quality of the broadcast lighting.

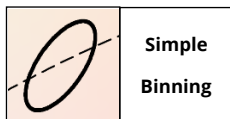

Simple Binning

SimpleBinning specification

Simplify the chromaticity binning with TrueChroma data support to provide the most economical, simple, and practical solution to customers.

**IEC 62471:2006 certification**

Result in the Exempt Group (RG0) for reliable photobiological safety at the rated power.

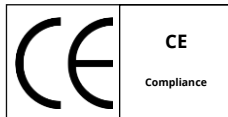
**RoHS 2011/65/EU compliance****CE compliance****REACH compliance (Phosphor)**

Ordering information

PART NUMBER	PRODUCT CODE	CCT	CHROMATICITY BINS	VOLTAGE RANGE
YJ-VTC-2835X-G02-27	P3190001.27	2700K	V27L, V27R	0.1V
YJ-VTC-2835X-G02-32	P3190001.32	3200K	V32L, V32R	0.1V
YJ-VTC-2835X-G02-50	P3190001.50	5000K	V50L, V50R	0.1V
YJ-VTC-2835X-G02-56	P3190001.56	5600K	V56L, V56R	0.1V
YJ-VTC-2835X-G02-65	P3190001.65	6500K	V65L, V65R	0.1V
YJ-VTC-2835X-G02-XX	P3190001.XX	Custom CCT	-	0.1V

Characteristics

Electrical-optical characteristics ($T_A = 25^\circ\text{C}$, 60mA)

PARAMETER	SYMBOL	VALUE			UNIT	TOLERANCE
		MIN.	TYP.	MAX.		
Forward voltage	V_F	3.0	-	3.4	V	± 0.05
Luminous flux	Φ_{2700K}	10	-	14	lm	-
	Φ_{3200K}	12	-	16		
	Φ_{5000K}	13	-	18		
	Φ_{5600K}	13	-	18		
	Φ_{6500K}	13	-	18		
Correlated color temperature¹	CCT_{2700K}	2550	-	2850	K	-
	CCT_{3200K}	3050	-	3350		
	CCT_{5000K}	4800	-	5200		
	CCT_{5600K}	5300	-	5900		
	CCT_{6500K}	6000	-	7000		
Color rendering index	R_a	95 ²	-	-	-	± 1
TCS R9 (CRI red)	R_9	-	90	-	-	-
Fidelity index³	R_f	-	97	-	-	-
Gamut index³	R_g	-	100	-	-	-
TLCI 2012⁴	-	-	99	-	-	-
Reverse current	I_r	-	-	10	μA	$\pm 0.1 (V_r = 5V)$
View angle	$2\theta_{1/2}$	-	120	-	Deg	± 5

1. Yujileds® promises the chromaticity coordinate tolerance of ± 0.0015 (CIE 1931 x,y) based on Yuji standard equipment shall prevail.
2. R_a typical 95 at 6500K.
3. Defined by the IES TM-30-18 method, this data is for trial.
4. Defined by the EBU, TLCI is the abbreviation of Television Lighting Consistency Index, this data is for trial.
5. This data is for reference only.

Characteristics

Absolute maximum ratings ($T_A = 25^\circ\text{C}$)

PARAMETER	SYMBOL	LIMIT	UNIT
Power Consumption	P_D	330	mW
DC Forward Current (pulsed)¹	I_{FP}	180 ²	mA
DC Forward Current	I_F	90	mA
Reverse Voltage	V_R	5	V
Junction Temperature	T_j	120	°C
Solder Point Temperature³	T_s	85	°C
Operating Temperature	T_{opr}	-40 ~ +85	°C
Storage Temperature	T_{stg}	-30 ~ +100	°C
Soldering Temperature	T_{sol}	260 ± 5	°C
Reflow Cycles Allowed	-	2	-

1. Pulse width $\leq 0.1\text{ms}$, duty $\leq 1/10$.
2. Theoretical data.
3. See page [Package material and dimension](#).

Chromaticity group and diagram

Chromaticity bins & coordinates

CCT	BIN	CIE 1931 COORDINATES							
		X0	Y0	X1	Y1	X2	Y2	X3	Y3
2700K	V27L	0.4525	0.4160	0.4440	0.4000	0.4552	0.4025	0.4642	0.4185
	V27R	0.4642	0.4185	0.4552	0.4025	0.4672	0.4048	0.4775	0.4215
3200K	V32L	0.4187	0.4065	0.4125	0.3906	0.4213	0.3940	0.4284	0.4103
	V32R	0.4284	0.4103	0.4213	0.3940	0.4309	0.3972	0.4389	0.4143
5000K	V50L	0.3376	0.3605	0.3371	0.3453	0.3450	0.3518	0.3462	0.3672
	V50R	0.3462	0.3672	0.3450	0.3518	0.3540	0.3590	0.3560	0.3743
5600K	V56L	0.3232	0.3470	0.3239	0.3338	0.3301	0.3389	0.3298	0.3529
	V56R	0.3298	0.3529	0.3301	0.3389	0.3371	0.3447	0.3376	0.3595
6500K	V65L	0.3045	0.3261	0.3069	0.3141	0.3139	0.3212	0.3123	0.3335
	V65R	0.3123	0.3335	0.3139	0.3212	0.3222	0.3293	0.3214	0.3413

CIE 1931 diagram

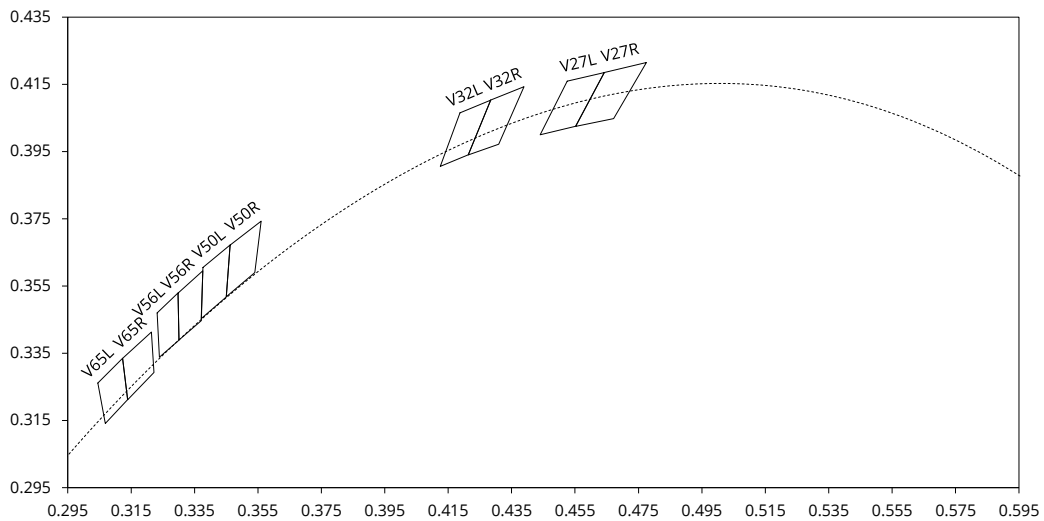

Package material and dimension

Package layout

All dimensions in mm, tolerance unless mentioned is ± 0.1 mm.

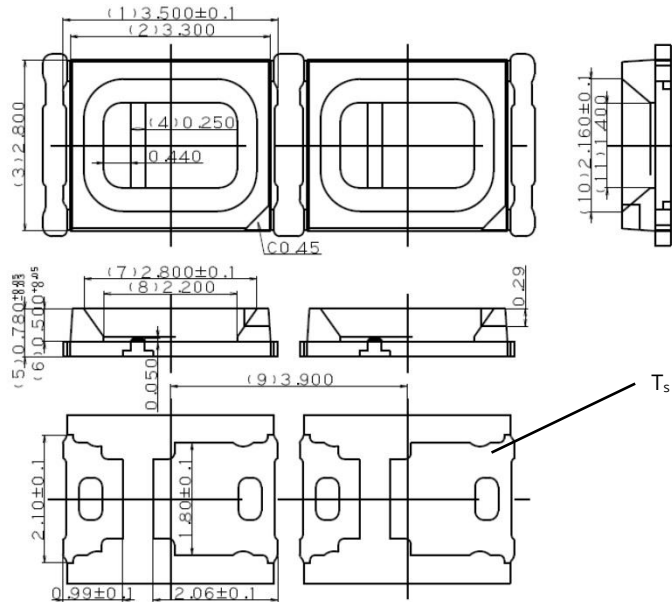

Package materials

ITEM	DESCRIPTION
Die material	InGaN
Lead frame material	PPA
Encapsulant resin material	Silicon + Phosphor
Electrodes material	Silver-plated copper

Characteristic graph

Typical spectral power distribution (normalized)

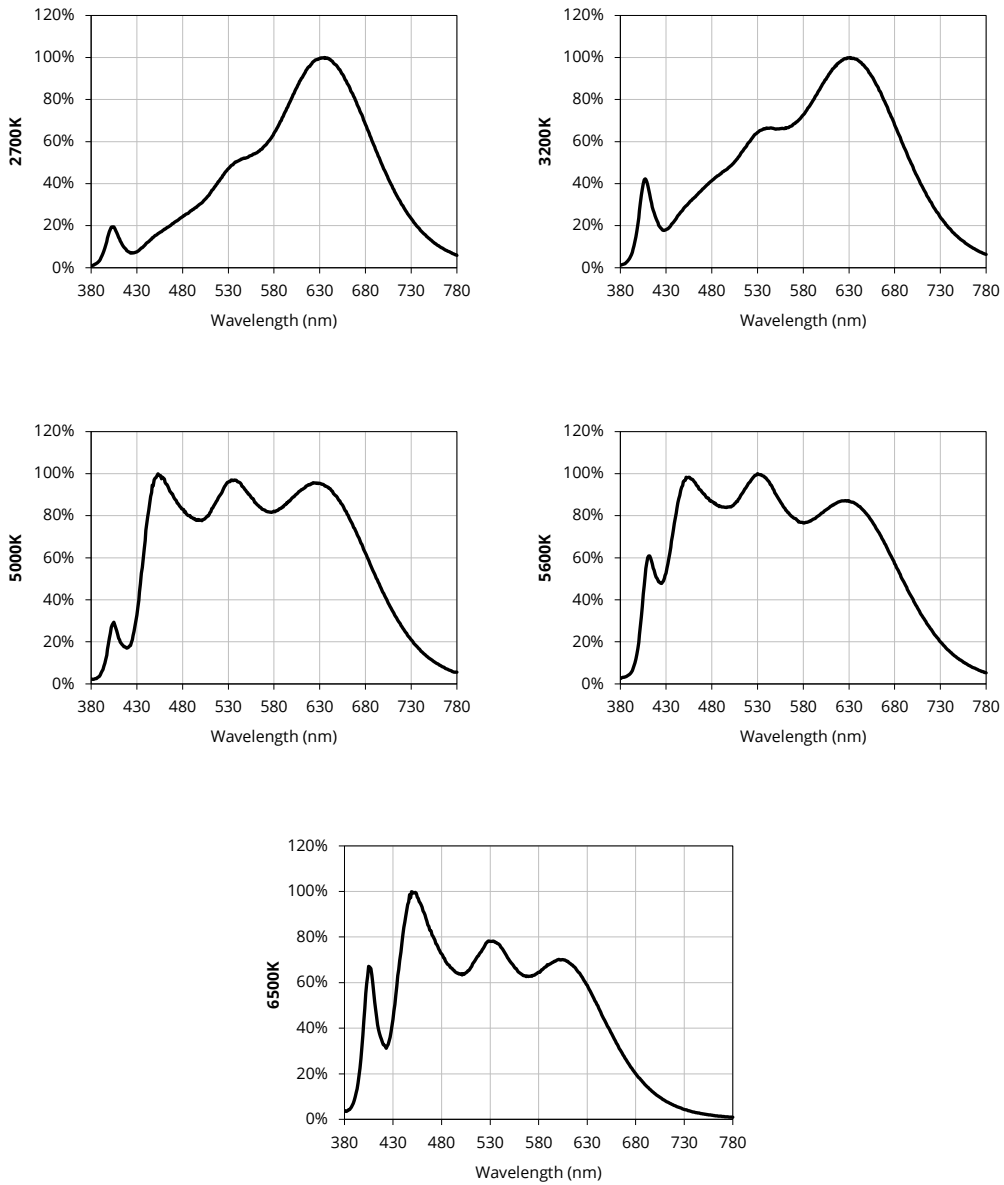

Characteristic graph

Forward current

All characteristic curves are for reference only and not guaranteed.

Vs. forward voltage

($T_A = 25^\circ\text{C}$)

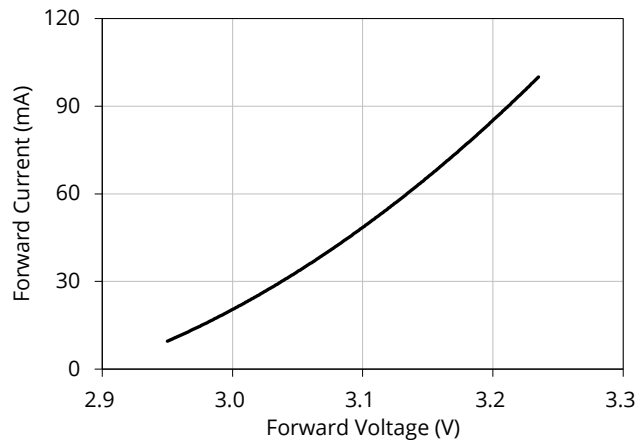

Vs. relative luminous flux

($T_A = 25^\circ\text{C}$)

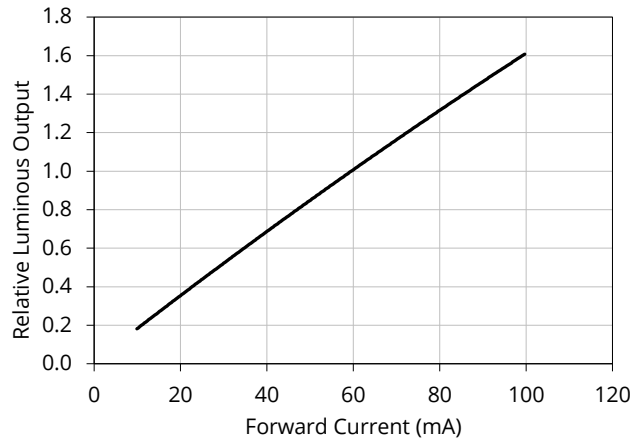

Characteristic graph

Forward current (continued)

All characteristic curves are for reference only and not guaranteed.

Vs. relative chromaticity shift

(5000K, $T_A = 25^\circ\text{C}$)

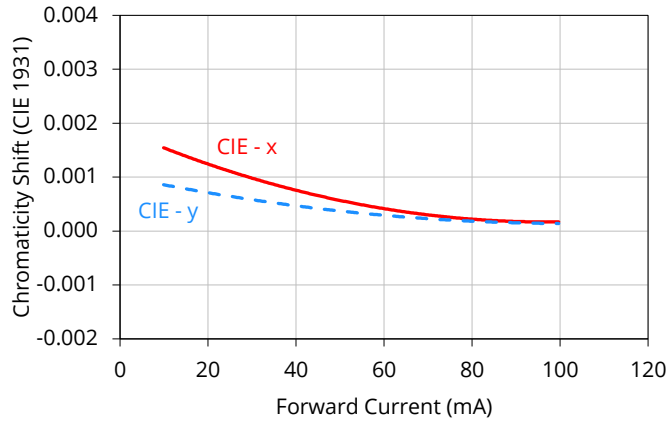

Vs. absolute chromaticity shift

(5000K, $T_A = 25^\circ\text{C}$)

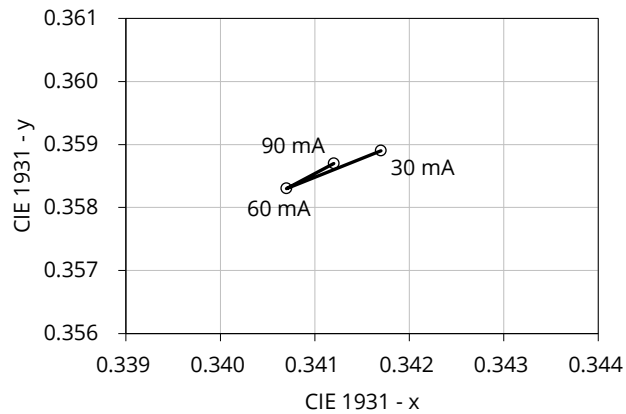

Derating based on solder point

Note: De-rating curves are meant for recommendation only and are not meant to provide guarantees of product stability and longevity.

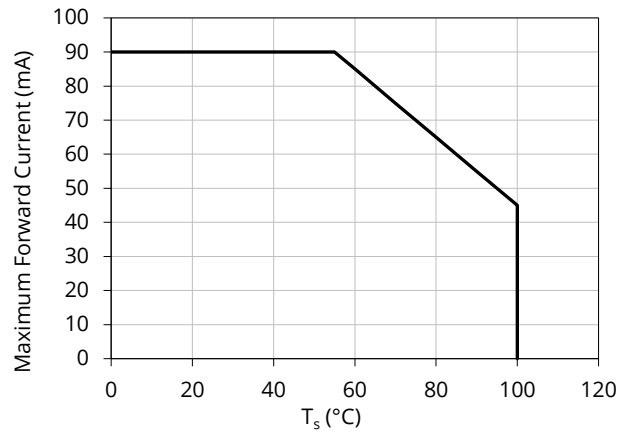

Characteristic graph

Solder point temperature (T_s)

All characteristic curves are for reference only and not guaranteed.

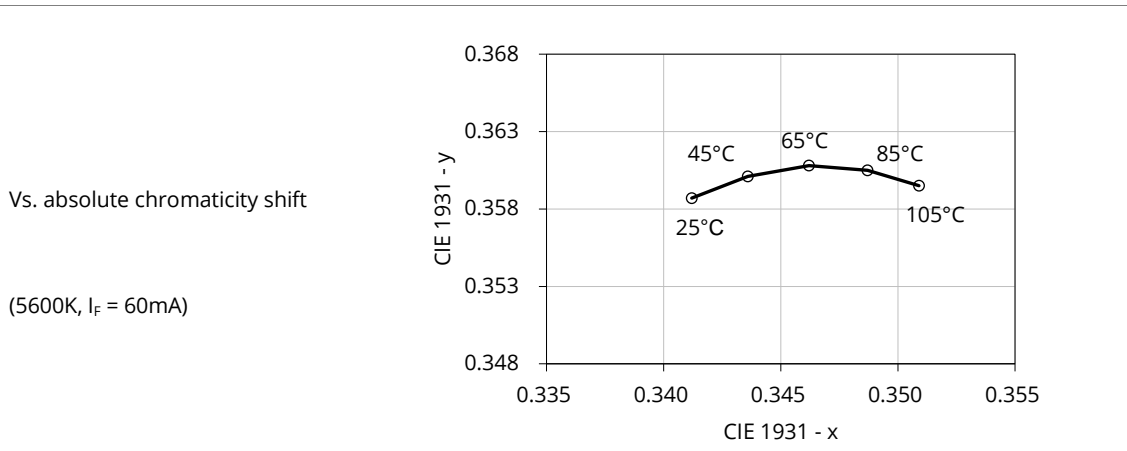
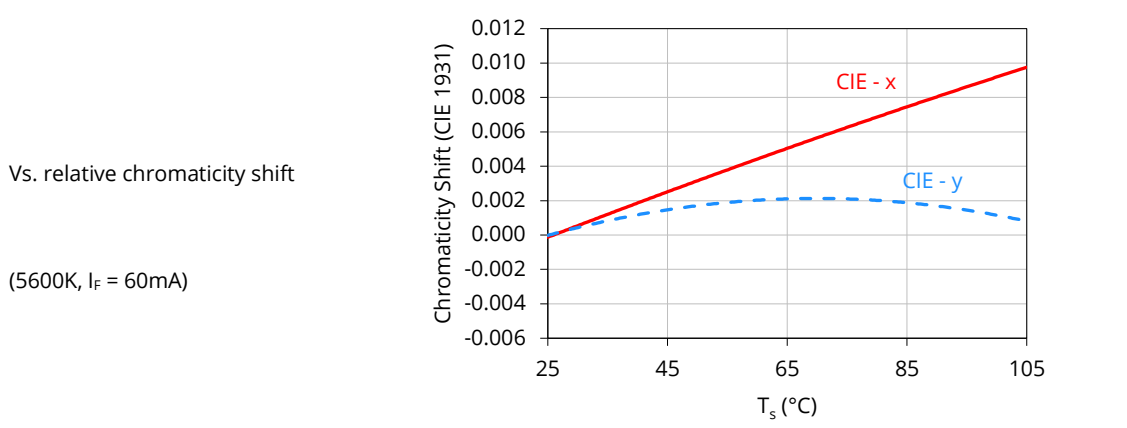
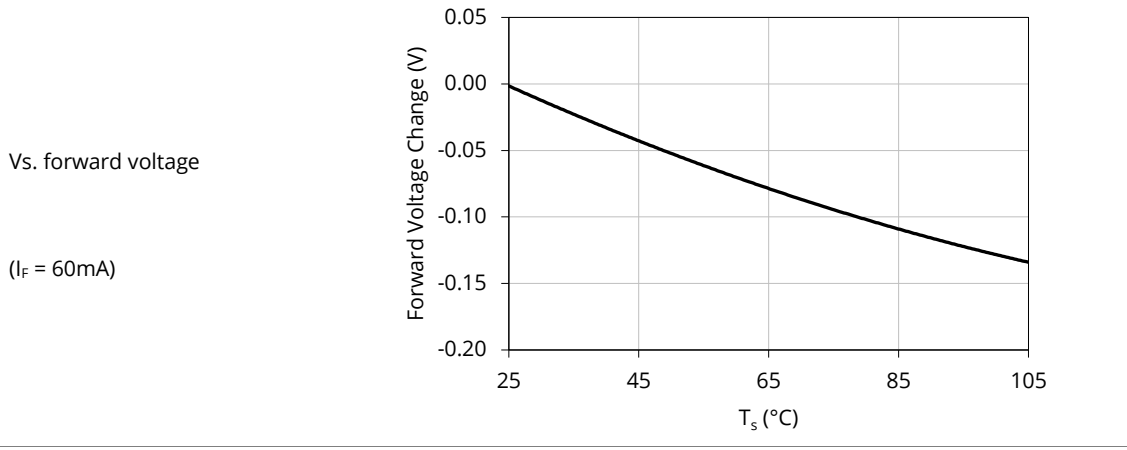

Characteristic graph

Spatial distribution ($T_A = 25^\circ\text{C}$, $I_F = 60\text{mA}$)

All characteristic curves are for reference only and not guaranteed.

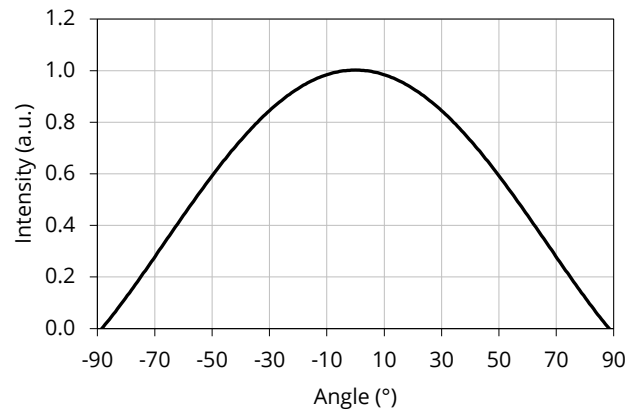

Solder and reflow profile

Recommended solder pad layout

All dimensions in mm, tolerance unless mentioned is ± 0.1 mm.

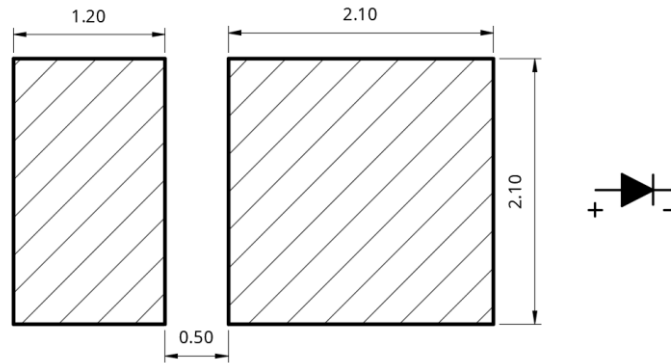

Reflow profile

Soldering ramp-up time (Pb-FREE).

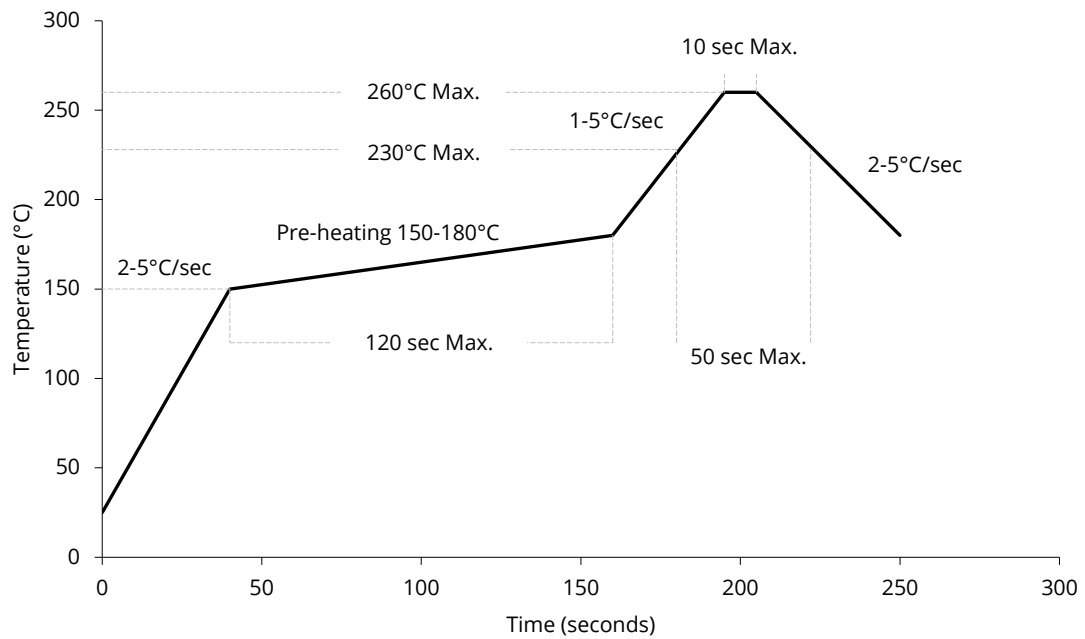

Note: Soldering paste with the melting point at 230°C is recommended.

SMT instruction

Problems caused by improper selection of collet

Choosing the right collet is important in ensuring product quality after SMT. LEDs are different from other electronic components, as they are not only concerned with electrical output but also optical output. This characteristic makes LEDs more fragile in the process of SMT. If the collet's lowering height is not well set, it will bring damage to the gold wire at the time of collet's pick-and-place process which can cause the LED to not illuminate, flicker or contribute to other quality problems, some of which may not be immediately detectable.

Collet selection

During SMT, please choose the collet that has larger outer diameter than the lighting area of lens, in order to avoid damage the gold wire inside the LED. Different collets fit for different products, please refer to the following figures below.

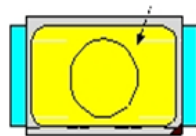

OK

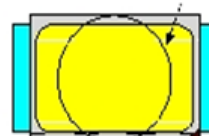

NOT OK – COLLET TOO SMALL

Setting the height of the collet is crucial in order to avoid damage to the top view SMD. If the collet setting is set to too low of an altitude, the collet will press down on the SMD, causing damage or breakage to the encapsulant and cause distortion or breakage of the gold wire.

Other notes of caution

- No pressure should be exerted to the epoxy shell of the SMD under high temperature.
- Do not scratch or wipe the lens since the lens and gold wire inside are rather fragile and cross out easy to break.
- LED should be used as soon as possible when being taken out of the original package, and should be stored in anti-moisture and anti-ESD package.
- This usage and handling instructions are for reference only.

Tape and reel specifications

Reel dimensions top (unit: mm)

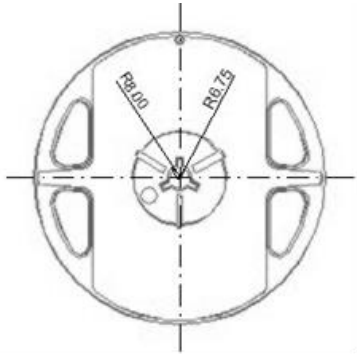

Reel dimensions bottom (unit: mm)

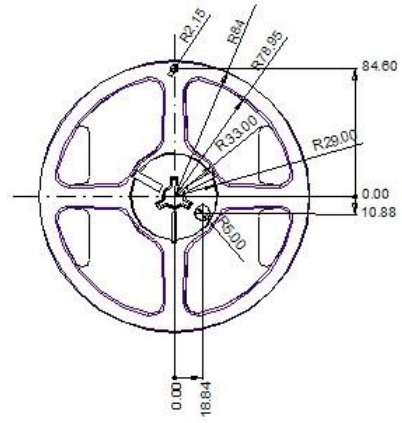

Reel dimensions side (unit: mm)



Feeding direction

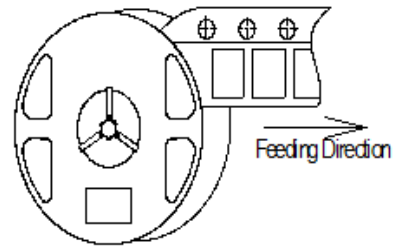

Box packaging

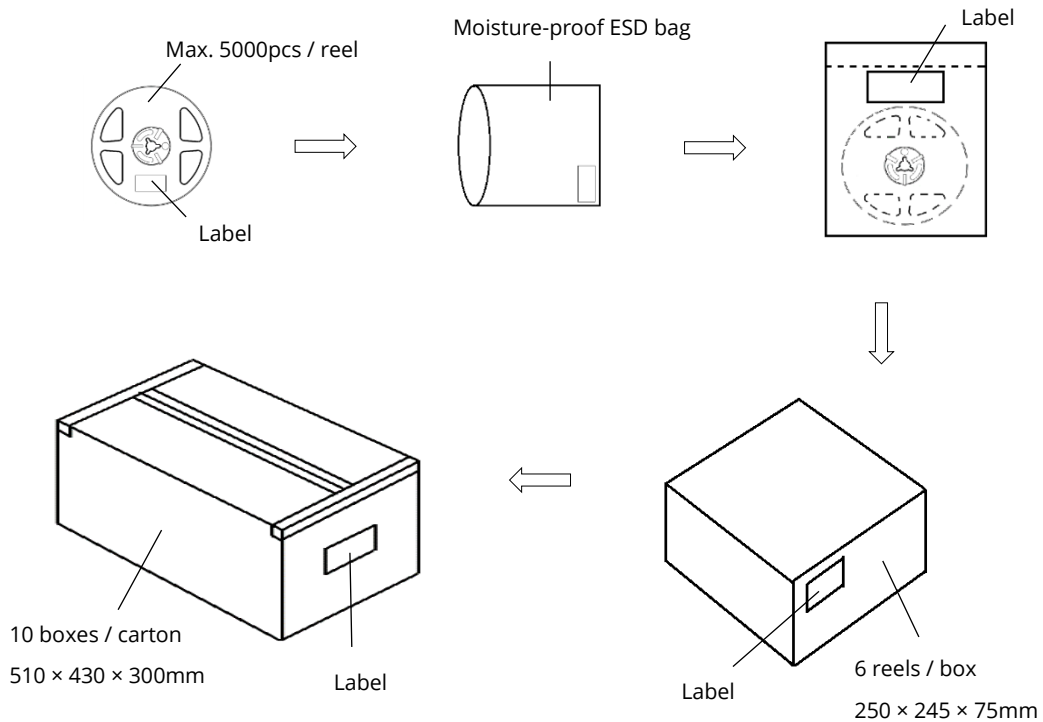

- Reeled products (max 5000pcs / reel) are packed in a moisture-proof bag along with a moisture desiccant pack.
- Each inner box contains up to 6 moisture-proof bag (total maximum number of SMDs is 30000pcs). Box package size: 250 mm × 245 mm × 75 mm.
- Each outer package contains 10 inner boxes. Box size: 510 mm × 430 mm × 300 mm.
- Outer package is sealed with protective bubble wrap and foam. (Part numbers, lot numbers, quantity should appear on the label on the moisture-proof bag, part numbers).
- This packaging merely intended as a reference for standard quantity orders only – please note that actual packaging can differ depending on the order circumstances.

About Yujileds



The Yuji story

Yuji started with LED phosphor materials in 2006, and today we are known for nitride red LED phosphor with superior brightness and stability in the world. With the rapid growth in LED industry during the past years, we have serviced over 260 business customers in over 33 different countries or regions, and established subsidiaries or distributors in 6 locations including China, US, UK and Japan, now we are reaching the global markets with the full coverage efficiently.

Our capabilities and achievements

In Yujileds®, we are a group of people passionate in creating the maximum value for customers. Dedicated to developing LED phosphor, LED light source and final products, we have accumulated unique experience in different projects. Nowadays, over 30 experts are gathered in a variety of areas including but not limited to semiconductor, chemistry, optics, photoelectricity, circuitry, materials and color science.

In commercial markets, we have been dedicating to providing comprehensive solutions for specific applications by deeply understanding these markets. Our goal is not only to offer an LED product simply but is to grow with customers and share the success of a business.

Main website: www.yujiintl.com

Find the comprehensive introduction of Yuji company and our insights into a variety of advanced technologies and applications.

Contact: info@yujigroup.com

Subordinative website: www.yujileds.com

Find more about our products, technical posts, featured support and service, blogs, news and whatever interesting and practical information.

Contact: contact@yujileds.com

Online shop: store.yujiintl.com

Find your favorite Yujileds® products with outstanding quality, fast shipment and superb sale service.

Contact: webstore@yujigroup.com