



YJ-RGB5050L-G01

Surface Mount Device

Applications

- High-end architectural lighting
- Photographic/broadcast lighting
- Photoelectric device and relevant research



Features

- Multiple color solution
- Full-color gamut of red, green and blue
- 5.0 mm × 5.5mm package

[About Yujileads[®]](#)

Document Number: YJWJ050

Rev Version: 2.0

P3180004.00

Table of Contents

General description	2
Ordering information	3
Characteristics	4
Electrical-optical characteristics.....	4
Absolute maximum ratings	5
Package material and dimension.....	6
Package layout.....	6
Solder and reflow profile	7
Recommended solder pad layout.....	7
Reflow profile.....	7
SMT instruction	8
Problems caused by improper selection of collet.....	8
Collet selection.....	8
Other notes of caution.....	8
Tape and reel specifications	9
About Yujileds	10

General description

YUJILEDS® Multichromatic series 5050 3-in-1 LED combines red, green and blue dies in one package. The compact package and high output make the LED suitable for a wide variety of applications demanding higher color quality distribution, and it also simplify the optical design.

The Multichromatic series 5050 LED also supports the unique service/certification by Yujileds® as described below.



RoHS 2011/65/EU compliance

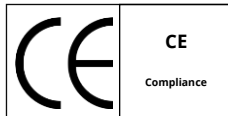

CE compliance



REACH compliance (Phosphor)

Ordering information

PART NUMBER	PRODUCT CODE	COLOR
YJ-RGB5050L-G01	P3180004.00	R, G, B

Characteristics

Electrical-optical characteristics ($T_A = 25^\circ\text{C}$, 20mA)

COLOR	PARAMETER	SYMBOL	VALUE			UNIT
			MIN.	TYP.	MAX.	
Red	Forward voltage	V_F	-	2.0	-	V
	Luminous flux	Φ	700	800	900	mcd
	Dominant wavelength	λ	620	625	630	nm
	View angle	$2\theta_{1/2}$	-	120	-	Deg
Green	Forward voltage	V_F	-	3.0	-	V
	Luminous flux	Φ	1600	1700	1800	mcd
	Dominant wavelength	λ	520	525	530	nm
	View angle	$2\theta_{1/2}$	-	120	-	Deg
Blue	Forward voltage	V_F	-	3.0	-	V
	Luminous flux	Φ	500	550	600	mcd
	Dominant wavelength	λ	465	470	475	nm
	View angle	$2\theta_{1/2}$	-	120	-	Deg

Characteristics

Absolute maximum ratings ($T_A = 25^\circ\text{C}$)

PARAMETER	SYMBOL	LIMIT	UNIT
Power Consumption	P_D	200	mW
Forward Current	I_F	3*20	mA
Peak Forward Current	I_{FP}	3*60	mA
Reverse Voltage	V_R	5	V
Operating Temperature	T_{opr}	-20 ~ +70	$^\circ\text{C}$
Storage Temperature	T_{stg}	-30 ~ +80	$^\circ\text{C}$
Soldering Temperature	T_{sol}	245 \pm 5	$^\circ\text{C}$

Package material and dimension

Package layout

All dimensions in mm, tolerance unless mentioned is ± 0.1 mm.

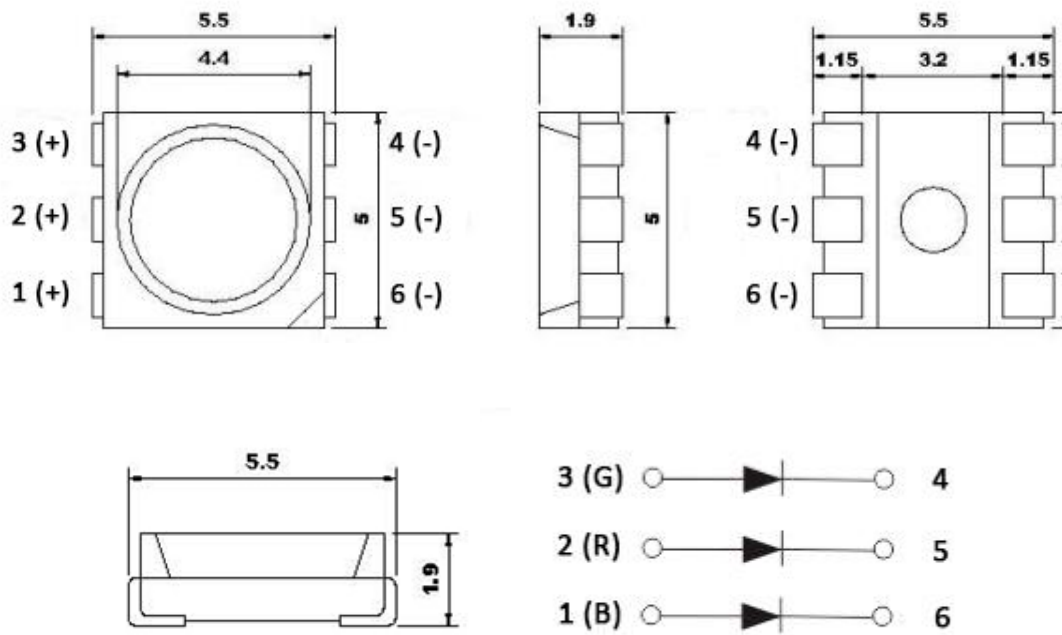

Solder and reflow profile

Recommended solder pad layout

All dimensions in mm, tolerance unless mentioned is ± 0.1 mm.

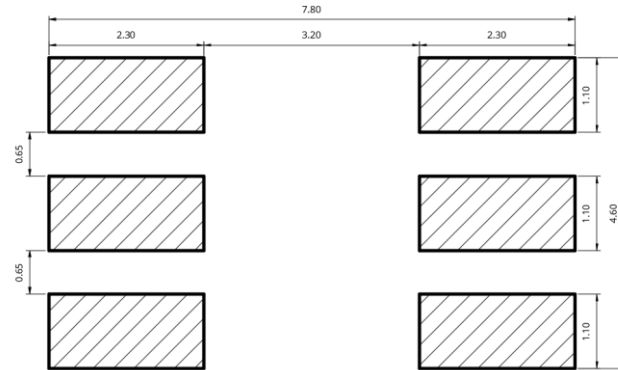

Reflow profile

Soldering ramp-up time (Pb-FREE).

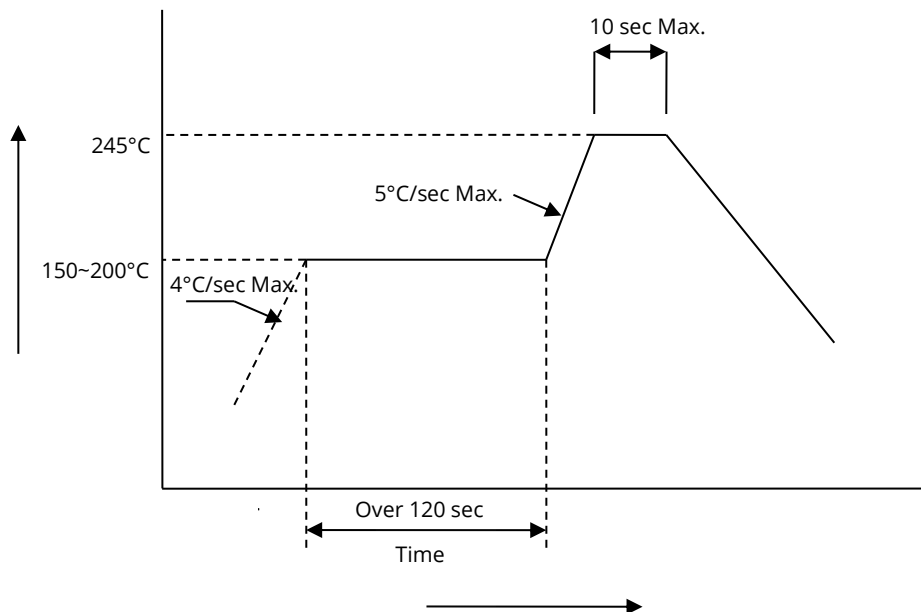

SMT instruction

Problems caused by improper selection of collet

Choosing the right collet is important in ensuring product quality after SMT. LEDs are different from other electronic components, as they are not only concerned with electrical output but also optical output. This characteristic makes LEDs more fragile in the process of SMT. If the collet's lowering height is not well set, it will bring damage to the gold wire at the time of collet's pick-and-place process which can cause the LED to not illuminate, flicker or contribute to other quality problems, some of which may not be immediately detectable.

Collet selection

During SMT, please choose the collet that has larger outer diameter than the lighting area of lens, in order to avoid damage the gold wire inside the LED. Different collets fit for different products, please refer to the following figures below.

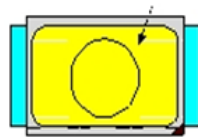

OK

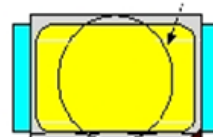

NOT OK – COLLET TOO SMALL

Setting the height of the collet is crucial in order to avoid damage to the top view SMD. If the collet setting is set to too low of an altitude, the collet will press down on the SMD, causing damage or breakage to the encapsulant and cause distortion or breakage of the gold wire.

Other notes of caution

- No pressure should be exerted to the epoxy shell of the SMD under high temperature.
- Do not scratch or wipe the lens since the lens and gold wire inside are rather fragile and cross out easy to break.
- LED should be used as soon as possible when being taken out of the original package, and should be stored in anti-moisture and anti-ESD package.
- This usage and handling instructions are for reference only.

Tape and reel specifications

Packing unit 1000pcs / reel

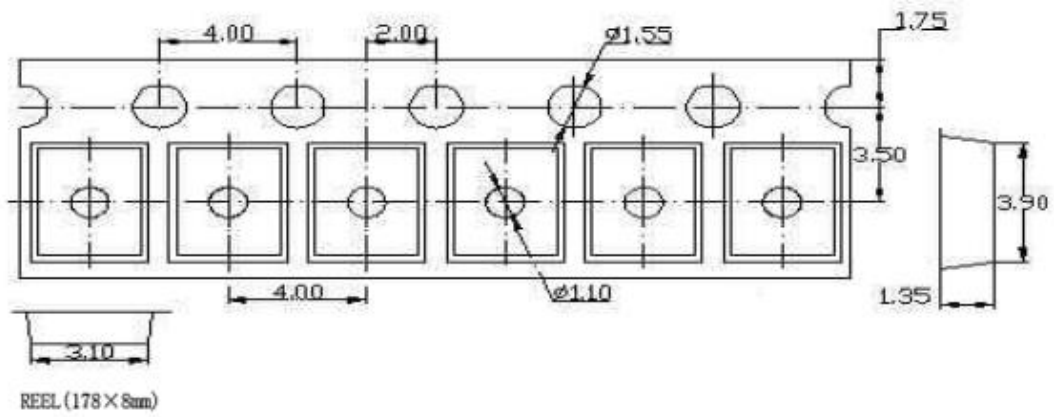

About Yujileds



The Yuji story

Yuji started with LED phosphor materials in 2006, and today we are known for nitride red LED phosphor with superior brightness and stability in the world. With the rapid growth in LED industry during the past years, we have serviced over 260 business customers in over 33 different countries or regions, and established subsidiaries or distributors in 6 locations including China, US, UK and Japan, now we are reaching the global markets with the full coverage efficiently.

Our capabilities and achievements

In Yujileds®, we are a group of people passionate in creating the maximum value for customers. Dedicated to developing LED phosphor, LED light source and final products, we have accumulated unique experience in different projects. Nowadays, over 30 experts are gathered in a variety of areas including but not limited to semiconductor, chemistry, optics, photoelectricity, circuitry, materials and color science.

In commercial markets, we have been dedicating to providing comprehensive solutions for specific applications by deeply understanding these markets. Our goal is not only to offer an LED product simply but is to grow with customers and share the success of a business.

Main website: www.yujiintl.com

Find the comprehensive introduction of Yuji company and our insights into a variety of advanced technologies and applications.

Contact: info@yujigroup.com

Subordinative website: www.yujileds.com

Find more about our products, technical posts, featured support and service, blogs, news and whatever interesting and practical information.

Contact: contact@yujileds.com

Online shop: store.yujiintl.com

Find your favorite Yujileds® products with outstanding quality, fast shipment and superb sale service.

Contact: webstore@yujigroup.com