



Solar Controller / Battery Charger

Input: DC12/24V Solar panel (Max. 50V)

Output: DC12/24V 60A

Model Number: ZS-60A

User's Manual

FEATURE

- This solar controller is used for off-grid photovoltaic (PV) system, such as solar home system, small power station, etc.
- The charging management has been optimized to prolong battery life, and improved system performance.
- The solar controller provides a wide range of Battery type setting: Gel, AGM, Conventional lead-acid (WET), Calcium, LiFePO4, LTO (Lithium Titanium Oxide) Battery types selection.
- Industrial grade MCU control, Pulse width modulated (PWM) technology, high efficiency operation.
- Built in regulator to prevent the battery from being overcharged. Overcharging occurs when the charge voltage is unregulated. This can result in premature battery failure.
- Come with regulator to prevent the battery from being under charged, in the solar energy field, battery undercharge always occurs, especially on some Conventional lead –acid or Calcium batteries; The unit provides an automatic Equalization feature for deeply drained Conventional lead acid battery or Calcium battery, as well as provides a cycling automatic Equalizing feature every 28 days.
- Protects the battery from discharge at night. Under low light or no light conditions the solar panel voltage could be less than the battery voltage. The unit contains a special circuit which prevents current flowing back from the each battery and into the solar panel.
- Colored LED's to easily indicate the operational status and each battery conditions.
- Digital LCD to directly display the battery voltage, charging current, charging capacity, battery type, ambient temperature and faulty codes.
- Provides plug-in remote digital display meter (Optional).
- Provides external battery temperature sensor (Optional).
- Multi charging protections against reverse polarity, short circuit, over temperature, over voltage, etc.
- Surface Mount and weather proof.
- Conformal-coated circuit boards and heavy duty terminals apply to hostile environments.

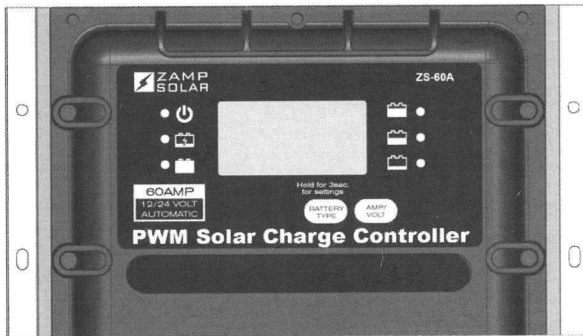

**Automatically used for 12Volt or 24V Solar Panel
Suitable for Solar panels up to 2000 Watts**

WARNING – IMPORTANT PLEASE READ

- This solar controller is designed for indoor use only and should never be exposed to rain or snow.
- Do not disassemble the controller. Take to a qualified person if the unit requires repairing.
- Lead acid batteries, LiFePO4 or LTO batteries can be dangerous. Ensure no sparks or flames are present when working near batteries.
- Eye protection should always be used. Never short circuit the battery
- Given sufficient light solar panels always generate energy even when they are disconnected.
- Accidental 'shorting' of the terminals or wiring can result in sparks causing personal injury or a fire hazard. We recommend that you cover up the panel(s) with some sort of soft cloth so you can block all incoming light during the installation. This will ensure that no damage is caused to the Solar Panel or Battery if the wires are accidentally short circuited.
- Always install a battery fuse on each circuit including the solar controller
- Do not reverse connect the wires to the solar panel or battery

MOUNTING THE DEVICE

Choose a location

The ZS-60A solar controller is designed to be mounted against a wall, out of the way but easily visible, it should be:

- Mounted on a vertical surface to optimize cooling of the solar controller.
- Mounted as close to the battery as possible to reduce the voltage drop on the cable.
- Mounted indoor, protected from the weather.

Note: If the unit is installed in a RV, the most common controller location is above the refrigerator. The wire from the solar array most commonly enters the RV through the fridge vent on the roof.

Dimensions for installation: Please refer to the following fig 1 and fig. 2:

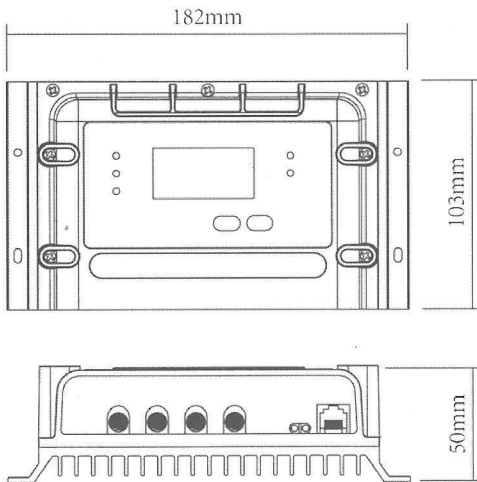

Fig 1:

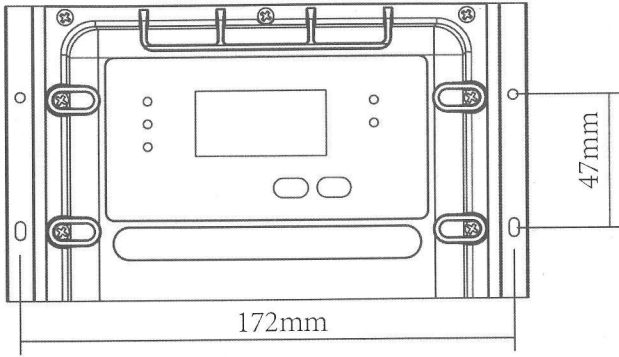
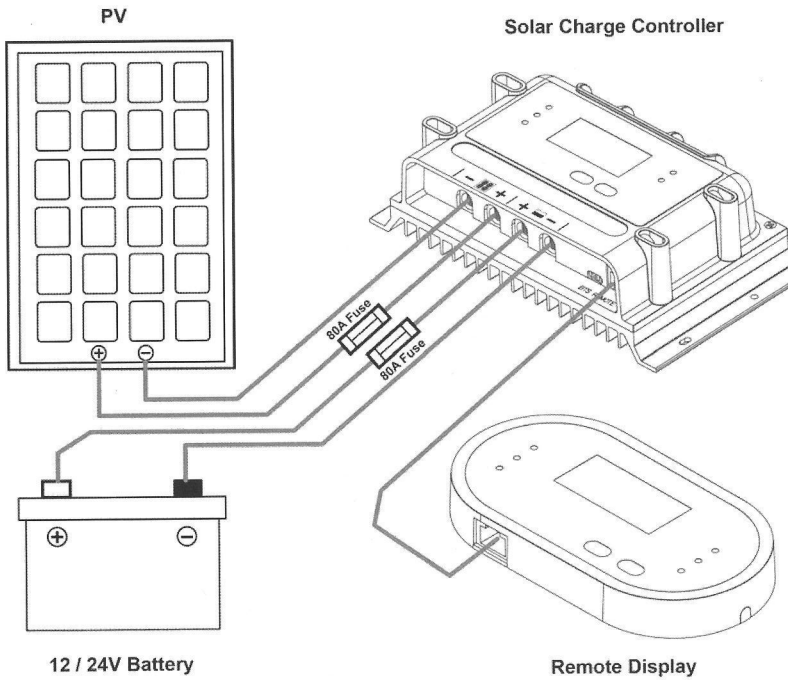

Fig. 2:

INSTALLATION INSTRUCTIONS

Fig.3: The wiring diagram.



Wiring Procedure:

1. Select the wire gauge as reference table as below:

	Battery Connection	Solar Array Connection		
Length of Wire	< 1m	6m	9m	12m
Size (AWG)	4 or 2	6	4	2

2. Identify the polarity (positive and negative) on the cable used for the battery and solar panel, would be best to use colored wires or mark the wire ends with tags.
3. Keep the solar panel covered with an opaque material until all wiring is completed. According to above the wiring schematic in fig.3, run wires from the solar panel and the batteries to the location of the ZS-60A.
4. Take off the cover bar of the ZS-60A, insert the cables into the power terminals as identified locations (identified Solar or Battery connected terminals).
5. Tightly secured the terminal screws; ensure the cables are reliably installed into the connection power terminals, and then put back the cover bar to the controller.

Please refer to the following fig. 4.

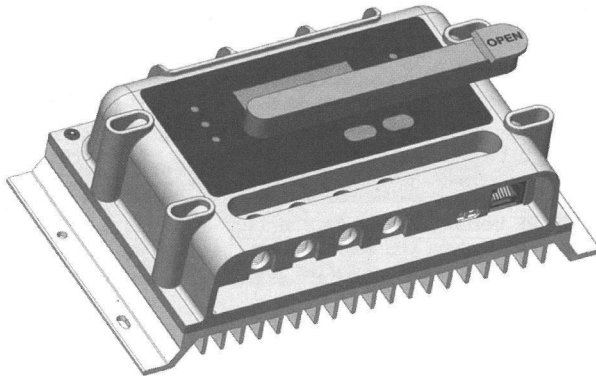

Fig. 4

6. After 30 days of operation, re-torque all terminal screws to ensure the wires are properly secured to the controller.

Caution 1: The 80Amp inline fuses must be connected into the positive wires as shown in the wiring schematic in fig.3

Caution 2: The ZS-60A solar controller installation must be made by specialized technique person, any wrong size of wires used or loose power connections or corroded wires can melt wire insulation, burn surrounding materials or even cause a fire. Ensure tight all connections and use cable clamps to secure cables.

NOTE: The ZS-60A controller has a common negative, it does not matter which Negative terminal is grounded.

When the connections are completed, the Controller will start working automatically.

OPERATION - LCD DISPLAY

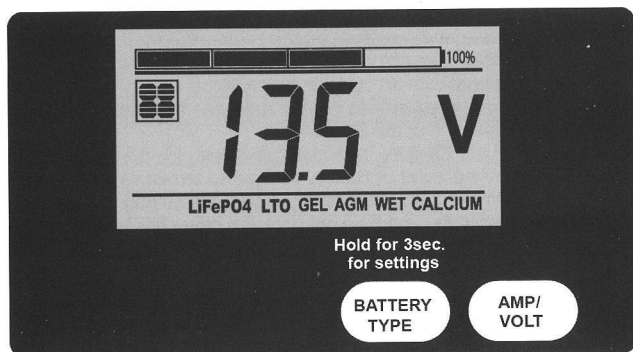

Battery type settings:

Please check your battery manufacturer's specifications to select correct battery type. The unit provides six (6) battery types setting for selections: Gel, AGM, WET (conventional lead acid), Calcium, LiFePO4 and LTO battery.

Press **BATTERY TYPE** button and hold for 3 seconds to go into your battery type selection mode, the battery type you select will be shown on the LCD meter, the default setting is AGM Battery; the controller will automatically memorize your battery type setting.

Caution: Incorrect battery type setting may damage your battery.

When the controller powers on, the unit will run self-qualify mode and automatically show below items on LCD before going into charging process

888 Self-test starts, digital meter segments test

009 Software version test

120^v Rated voltage test

600^A Rated current test

29^{°C} External battery temperature sensor test (if connected)



Indicate the solar panel connected.

After going into the charging process, press **VOLT / AMP button** in sequence, the LCD will display in turn with Battery Voltage, Charging Current, Charged capacity (Amp-hour) and Battery Temperature (if external temperature sensor connected).

Display in the day time-

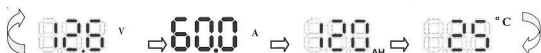

Display during the night-(The current and Amphour are shown 0)

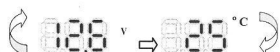

The **VOLT / AMP button** can be changed at any time during charging process. The LCD also can be treated as an independent voltage meter or thermometer. A voltage less than 11.5V/23.0 Volts indicate that the battery is discharged and needs re-charging.

You also can visually monitor your battery charging condition for each battery; there is a LCD bar to show how many percentage capacities are charged, you can easily see the battery is charged around 25%, 50%, 75% or 100%.



CHARGING STAGES

The ZS-60A has a 5 stage charging algorithm.

Soft Charge (Level 1) - Bulk Charge (Level 2) - Absorption charge (Level 3) - Equalizing Charge* (Level 4) - Float Mode (Level 5)

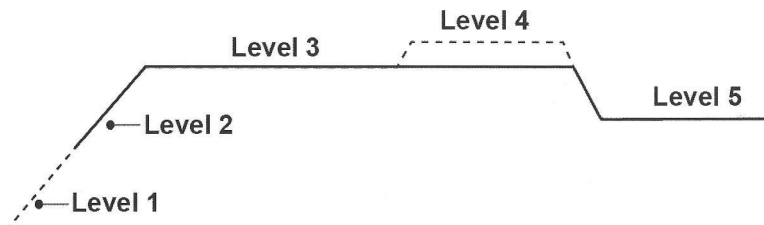

Soft Charge- When batteries suffer an over-discharge, the controller will softly ramps the battery voltage up to 10V / 20V.

Bulk Charge-Maximum current charging until batteries rise to Absorption level







Absorption Charge-Constant voltage charging and battery is over 85%.

Equalization Charge*-Only for WET battery or Calcium battery type, when the battery is deeply drained below 10V / 20V, it will automatically run this stage to bring the internal cells as an equal states and fully complement the loss of capacity.(Gel, AGM,LiFePO4 and LTO battery do not run Equalization charge)

Float Charge-Battery is fully charged and maintained at a safe level.
A fully charged battery has a voltage of more than 13.6 / 27.2 Volts.



Auto Equalize: The ZS-60A has an automatic equalize feature that will charge and recondition your battery once a month at a high voltage to ensure that any excess sulphation is removed and individual cells are balanced. This feature is available for Wet cell (flooded battery) or Calcium batteries. Check with your battery manufacture,









OPERATION - L.E.D. INDICATION

The 6 LED's indicate the charging status and the battery condition						
	Red	Blue	Green	Green	Yellow	Red
Solar Power Present-No battery connected	ON	OFF	OFF	OFF	OFF	Flash
Soft charging	ON	Flash	OFF	OFF	OFF	ON
Bulk charging	ON	ON	OFF	Subject to battery voltage		
Absorption charging	ON	ON	OFF	ON	OFF	OFF
Equalization charging	ON	ON	OFF	ON	OFF	OFF
Float charging	ON	OFF	ON	OFF	OFF	OFF
Solar panel weak	Flash	OFF	OFF	Subject to battery voltage		
At night no charge	OFF	OFF	OFF	Subject to battery voltage		
Battery Voltage below 11.5V (+/-0.2V)	ON	ON	OFF	OFF	OFF	ON
Battery Voltage between 11.5V - 12.5V(+/-0.2V)	ON	ON	OFF	OFF	ON	OFF
Battery Voltage above 12.5V (+/-0.2V)	ON	ON	OFF	ON	OFF	OFF

Values are for 12V use, x 2 for 24V use

ABNORMAL OPERATION MODE

Solar panel abnormal mode	LCD display	LED indication	LCD backlight
Solar panel weak		 Flash	ON
Solar panel reverse connection	800	 Flash	Flash
Solar panel over voltage (> 26.5V)	802	 Flash	Flash

Battery abnormal mode	LCD display	LED indication	LCD backlight
Battery disconnected or less than 3.0V	800	 Flash  Flash  Flash	Flash
Battery reverse connection	802	 Flash	Flash
Battery over voltage than > 17.5V	803	 Flash	Flash
Battery temperature over 65C	804	 Flash  Flash  Flash	Flash

The solar controller abnormal mode	LCD display	LED indication	LCD backlight
The controller over temperature protection	888		Flash

Values are for 12V use, x 2 for 24V use

OPTIONAL EXTERNAL DEVICE

The controller provides two optional devices (excludes in the packaging box).

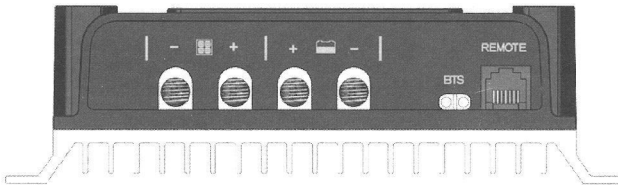

Optional external Battery temperature sensor (BTS):

As an option, the unit provides a port to connect an external battery temperature sensor; if the temperature sensor is connected, the unit will optimize the charging performance subjected to the battery temperature and also provide the battery over temperature protection; in some cases, if battery over temperature occurs, the controller will automatically stop charging.

Optional external Remote display meter (ZS-RT1):

As an option, the unit also provides a port to connect the external Remote display meter for some special location needed. The display content and operation buttons on the ZS-RT1 Remote meter is same as the display and operation on the ZS-60A controller.

REMOTE DISPLAY INSTALLATION

Installation Dimensions are shown in the following fig.5 and fig.6

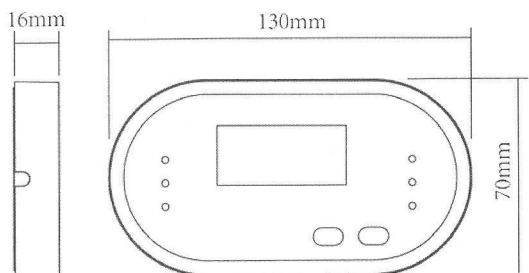

Fig. 5

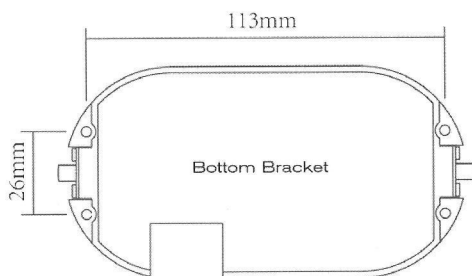
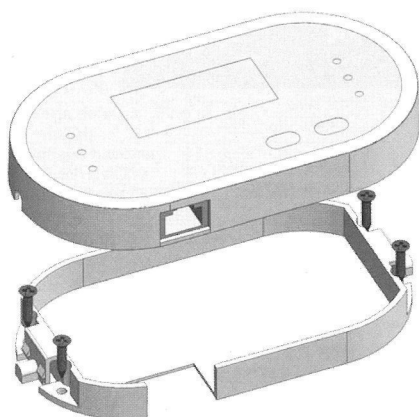

Fig. 6

Installation Procedure



1. Secure the bottom bracket to the wall.
2. Put the ZS-RT1 Remote unit to the bottom bracket. The remote unit will be self-secured to the bottom bracket.
3. Connect the remote wire to the ZS-60A controller.
4. If taken off the remote unit from the bottom bracket, please press down the small knob on the left and right side of the bottom bracket.

Note: Mounted in door, protected from weather.

SPECIFICATIONS

1	Electrical Parameters			
1-1	Rated solar panel amps	60	Max.	AMP
1-2	Normal input Solar cell array voltage	15-22		VDC
1-3	Max. solar cell array voltage (output has no load)	25	Max.	VDC
1-4	The controller lowest operating voltage (at solar or battery side)	8V	Min	VDC
1-5	Maximum voltage drop-Solar panel to battery	0.25	Max.	VDC
2	Charging characteristics			
2-1	Minimum battery start charging voltage	3	Min	VDC
2-2	Soft start charging voltage	3-10	+/-0.2	VDC
2-3	Soft start charging current (50% PWM duty)	Up to 30		AMP
2-4	Bulk charging current (100% PWM duty)	Up to 60		AMP
2-5	Bulk charge voltage	10-14.0	+/-0.2	VDC
2-6	Absorption charging voltage at 25°C			
	--LTO type battery ((Lithium Titanium Oxide battery)	14.0	+/-0.2	VDC
	--Gel type battery	14.1	+/-0.2	VDC
	--LiFePO4 battery	14.4	+/-0.2	VDC
	--AGM type battery (default setting)	14.4	+/-0.2	VDC
	--WET type battery	14.7	+/-0.2	VDC
	--Calcium type battery	14.9	+/-0.2	VDC
2-7	Absorption transits to Equalizing or Float condition:			
	--Charging current drops to	1.0	+0.1	AMP
	-- or Absorption charging timer timed out	4		Hour
2-8	Equalization charge active --- only for the battery type	WET or Calcium battery		
	--Battery voltage discharged to less than	10	+/-0.2	VDC
	--Automatic equalizing charging periodical	28		Day
2-9	Equalization charging voltage at 25°C	15.5	+/-0.2	VDC
2-10	Equalization charging timer timed out	2		Hour
2-11	Float charging voltage at 25°C	13.6	+/-0.2	VDC
2-12	Voltage control accuracy	+/- 1%		
2-13	Battery temperature compensation coefficient	-24		mV/°C
2-14	Temperature compensation range	-20 ~ +50		°C
3	Protection			
3-1	Reverse polarity or short circuit protections			
3-2	No reverse current from battery to solar at night			
3-3	Over temperature protection during charging	65		°C
3-4	Transient over voltage protection with TVS or varistor			
4	Electrical parts			
4-1	Input output terminal	M8 terminals		
4-2	Remote port	RJ-45 (8 pins)		
4-3	Remote connecting wires	#24AWG, 0.2mm2, 7 meter		
5	Physical Parameters			
5-1	Controller material	Plastic, Standard ABS		
5-2	Power terminal maximum stranded wire size	#2AWG stranded, 34mm2		
5-3	Power terminal torque	Up to 17 in-lb (0.2n-m)		
5-4	Mounting	Vertical wall mounting		
5-5	IP grade	IP22,		
5-6	Net weight	Approx. 0.45Kg		
6	Environmental characteristics			
6-1	Operating temperature	-25 ~ 50°C		
6-2	Storage temperature	-40 ~ 85°C		
6-3	Operating Humidity range	100% no condensation		

Values are for 12V use, x 2 for 24V use