

ZAMP  **SOLAR**[®]



CINDER[™] 40 PWM Charge Controller

CINDER 40 PWM
Part # SCC1005

Input: DC12V or DC24V solar panel (Max 50Voc)

Output: DC 12V 40A

DC 24V 40A

User Manual

THIS MANUAL CONTAINS IMPORTANT INSTRUCTIONS FOR
INSTALLATION AND MAINTENANCE OF THE
SCC1005 CHARGE CONTROLLER

Contents

1) IMPORTANT SAFETY INSTRUCTIONS - PLEASE READ	3
2) Overview	4
Intro	4
PulseTech	4
Bluetooth	4
Load Output Circuit	4
3) Features	5
4) Wiring and Installation	6
Important Installation Notes - Please Read	6
Device Connections	7
Installation Guide 12-Volt and 24-Volt	8
12-Volt Installation Specifics	9
24-Volt Installation Specifics	11
Load Output Circuit Details	13
5) Zamp Solar Mobile Application	14
Status Page	15
History Page	17
Settings Page	17
6) PulseTech Functionality	20
7) Charging Profiles	21
8) LED Operation	23
9) Troubleshooting	24
10) Specifications	25
11) Contact Us	26



Figure 1: CINDER 40 Top View



Figure 2: Front face of CINDER 40 showing all connections

1) IMPORTANT SAFETY INSTRUCTIONS - PLEASE READ

- THIS DEVICE IS INTENDED FOR INDOOR USE ONLY AND SHOULD NEVER BE EXPOSED TO RAIN, MOISTURE OR OUTDOOR ELEMENTS.
- "WARNING: WHEN A GROUND FAULT IS INDICATED, BATTERY TERMINALS AND CONNECTED CIRCUITS MAY BE UNGROUNDED AND HAZARDOUS."
- LEAD-ACID, AGM, LITHIUM, AND LTO BATTERIES CAN BE DANGEROUS. ENSURE NO SPARKS OR FLAMES ARE PRESENT WHEN WORKING NEAR BATTERIES.
- NEVER SHORT CIRCUIT THE BATTERY.
- SOLAR PANELS WILL GENERATE ENERGY WHEN THEY ARE EXPOSED TO LIGHT EVEN WHEN DISCONNECTED. ANY CONTACT WITH WIRES CAN CAUSE INJURY.
- NEVER USE THIS DEVICE WITH A LITHIUM BATTERY THAT DOES NOT HAVE A BMS. A BMS IS CRITICAL FOR LITHIUM BATTERY SAFETY.
- Eye protection should always be used when working near batteries.
- Accidental shorting of the wiring during installation can result in sparks causing personal injury or a fire hazard. Zamp Solar recommends covering the solar panels to block all light from reaching the surface during installation.
- Use 6 AWG, 90°C copper wire for the Solar and Battery connections.
- Always install a battery fuse (50-amp recommended) between the battery and the solar controller. (see [Section 4](#) for more details on fusing).
- Be very careful not to connect the wires to the solar panel or battery in reverse. (See Figure 2 above for connection layout)
- Do not disassemble the CINDER 40. Please contact Zamp Solar Customer Service if you have any problems with your device. 541-728-0924 or support@zampsolar.com.
- Device has overcurrent protection up to 50 amps on both the Solar and Battery terminals.
- Zamp Solar recommends not exceeding 40-amps of short circuit current (I_{sc}) for your solar input.
- Audible noise during charging is normal, particularly during absorption and float modes. The noise is due to the PWM charging functionality of the device and not an indication of a device failure.

2) Overview

Intro

The Zamp Solar CINDER 40 solar charge controller automatically controls the attached solar input to charge the connected battery and keep it at optimal battery health. The CINDER 40 also monitors, regulates and protects the attached solar and battery components. Equipped with advanced, high efficiency, pulse width modulated (PWM) technology and temperature compensation, batteries safely charge to 100% every time.

PulseTech

Patented PulseTech pulsing technology increases the life of lead-acid batteries. PulseTech works by removing and hindering the natural sulfation (corrosion) that occurs in all lead-acid/AGM batteries that eventually leads to a dead battery. PulseTech patented desulfating technology has been proven to increase the life of lead-acid/AGM batteries by up to three times their normal life. This technology is built into the CINDER 40 and can be turned on for any lead-acid/AGM battery charging profile.

Bluetooth

Use our Android and iOS apps with our built-in Bluetooth technology to program, control and monitor your battery(s). Get real-time charging and battery statistics at the touch of a button on your smart device. Check the history page for long term performance data and statistics. Program when the load output circuit should turn on and off and set low voltage disconnects. See [Section 5](#) for more details on the Zamp Solar application.

Load Output Circuit

Power and control DC devices using our Load Output Circuit. The CINDER 40 load circuit will power devices that run on 12-volt or 24-volt, depending on battery configuration. The load circuit is not for use with any DC/AC power inverters. Use our Android or iOS app to turn this circuit On/Off or program to run at certain times during the day.

3) Features

1. Premium 40-amp Pulse Width Modulation (PWM) Solar Charge Controller
2. Charge 12-volt and 24-volt battery systems using 12-volt or 24-volt solar panels
3. Preprogrammed and customizable battery charging profiles
 - a. AGM, WET, GEL and Calcium lead-acid type batteries
 - b. Lithium (LiFePO₄/Lithium Ion) and lithium titanate oxide (LTO) type batteries
 - c. Customize any charging profile for specific battery needs. (see [Section 7](#) for more detail on custom charging profiles)
4. PulseTech pulsing technology increases the life of all lead-acid battery types (see [Section 6](#) for more details on the PulseTech functionality)
5. Built-in Bluetooth technology allows remote monitoring and control of the battery and load output circuit. Change battery settings, charging profiles and toggle the load output circuit all from our mobile app. Available for both Android and iOS. (see [Section 5](#) for more details on the Zamp Solar Application)
6. Robust safety and protection
 - a. Protects battery from over-voltage or over-current scenarios
 - b. Protection from reverse polarity or reverse current
 - c. Battery temperature protection (see [Section 7](#) for more information)
 - d. Load output short circuit protection.
7. Load output circuit
 - a. App controlled - Turn a circuit on/off on demand or automatically at programmed times
 - b. Smart monitoring and low voltage cutoff to prevent battery from being discharged to unsafe levels.
 - c. Ideal for lighting and other small loads
 - d. Fuse protected at 25-amps.
 - e. Not for use with a DC/AC inverter
8. Battery temperature compensation
 - a. External battery temperature sensor included with device.
 - b. Improves charging accuracy for all lead acid battery types.
 - c. Prevents damage during temperature extremes for all lead acid battery types.
9. LED lights indicate battery status, solar panel status, load status, Bluetooth status and PulseTech status.
10. RV-C Capable
 - a. Receive charging data
 - b. Request specific Data
 - c. Control Load circuit

4) Wiring and Installation

See the following six pages for the installation guides for both 12-volt and 24-volt systems. See the mounting diagram in [Section 10](#) for detailed dimension information.

Important Installation Notes - Please Read

1. Use 6-AWG, 90°C copper wire for the Solar and Battery connections.
2. Ensure that your solar input has a maximum short circuit current (I_{sc}) of less than 40 amps.
3. To protect the battery and the solar panel, a 50-amp inline fuse must be placed between the charge controller and the battery. This fuse should be located as close to the battery as possible for optimal performance.
4. The maximum overcurrent of the CINDER 40 is 50 amps.
5. Use up to 6-AWG wire for Load connections (see [Load Output Circuit Details Section](#) below for specific wire size recommendations).
6. It is important to use the external temperature sensor to ensure proper battery charging for all lead acid battery types. Please use the supplied flathead screwdriver to connect the sensor to the charge controller (polarity does not matter) and either tape the ring terminal end to your battery or connect it to the positive battery post.
7. Immediately after connecting the battery to the charge controller, use the [Zamp Solar Mobile App](#) to set the proper battery charging profile or use the custom profile settings to adjust the charging profile. Do this before connecting your solar panels to the device. - **Follow the battery manufacturer's recommendations when using the custom profile setting.**

Device Connections



Figure 4: Bottom of CINDER 40 Showing All Connections

The CINDER 40 charge controller has 10 separate connection points which are detailed below. Note the orientation of each terminal; it does not follow the same polarity (+/-) pattern. **Connect the battery first, then the solar panels. It is very important that you connect your CINDER 40 with the proper polarity for each of the terminals or you can cause significant damage to the device. Be very careful not to connect solar panels to the battery terminals and vice versa.**

A removable service panel is located on the front of the charge controller for LOAD, BATTERY, SOLAR and TEMPERATURE connections. A standard flat head screwdriver is required to secure all of the following wired connections. Please use the supplied smaller flat head screwdriver to attach the Temperature sensor wires.

LOAD

Connect these terminals to any DC circuit up to 20 amps you wish to power off your battery. These terminals are internally fuse protected at 20A. (-) goes to the negative side of the load. (+) goes to the positive side of the load.

BATTERY

Battery connection terminals. (-) goes to the negative side of the battery. (+) goes to the positive side of the battery. Zamp Solar strongly recommends installing a 50-amp fuse inline on the positive wire leading to the battery. Connect the battery wiring first, then the solar panel wiring.

SOLAR

Solar connection terminals. (-) goes to the negative side of the solar panel. (+) goes to the positive side of the solar panel. Connect the Battery wiring first, then the Solar Panel wiring second.

TEMP

These terminals are for connecting the included temperature sensor. *NOTE: This sensor is not polarized, it does not require a specific orientation for proper installation.* Insert wires and screw tight. Tape ring terminal to the top of the battery or connect it to the positive battery post. (Do not use for Lithium batteries)

DISP & AUX

These terminals are RJ45 connectors for RV-C functionality as well as for future interconnectivity and development.

Installation Guide 12-Volt and 24-Volt

Charge Controller to Battery Wiring

Connect the charge controller to the battery using 10 feet (or less) of 6-AWG, 90°C copper wire. The shorter the wire run, the better. This is due to the voltage drop that occurs in the wires when the device is charging. When connecting the charge controller to the battery, ensure there is a 50-amp fuse between the charge controller and the battery on the positive side, as shown in Figures 5 and 7 below. Place the fuse as close to the battery as possible.

Battery Fusing

Examples of fuses to use are a terminal fuse block, manual resetting breaker or an ANL type fuse. A 50-amp fuse is recommended for all installations.

Automatic resetting breakers are NOT recommended.

Temperature Sensor

The CINDER 40 comes with a 10-foot temperature sensor that has a ring terminal on one end and two exposed leads on the other end. If using a lead acid battery, connect the temperature sensor leads to the charge controller's TEMP terminals. Note that there is no polarity with this connection. Once tight, give each lead a light tug to ensure that they are properly connected. Then, tape the ring terminal side of the temperature sensor to the side or the top of your battery. This is recommended over connecting it to one of the battery terminals because it will give a better gauge of the actual temperature of your battery. It is important to use the temperature sensor as described to accurately charge your lead acid battery bank over all temperature ranges. Do not use the temperature sensor for lithium batteries. (See the [Section 7](#) for information on temperature behavior during charging).

12-Volt and 24-Volt Load

Connect your 12-Volt DC circuits to the load terminal to enable remote control and monitoring of these devices. Please see the [Load Details section](#) for a full load description, examples and load wiring recommendations.

12-Volt Installation Specifics

Table 1: 12-Volt Installation Quick information

Maximum Nominal Panel Wattage	800W (<= 40A Isc)
Battery to Charge Controller Wire Size	6-AWG
Battery to Charge Controller Fuse Size	50A
Battery to Charge Controller Maximum Wire Length with 6-AWG	10 Ft
Solar Panel to Charge Controller Wire Size	6-AWG
Solar Panel to Charge Controller Maximum Wire Length with 6-AWG	10 Ft
Solar Panel Configuration	Parallel (12V)
Temperature Sensor	Tape to top or side of the Battery if lead acid
Load Output Voltage	12V
Load Output Current	20A

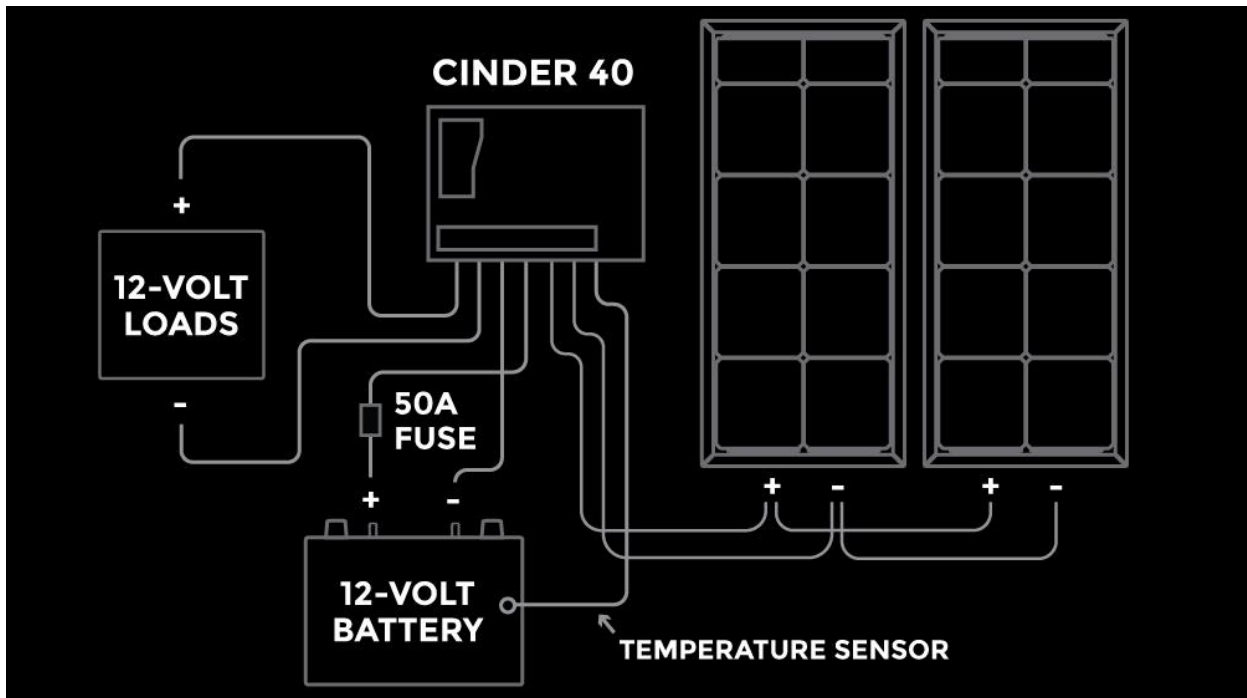

Figure 5: 12-Volt Installation Diagram

12-Volt Charge Controller to Solar Panel Wiring

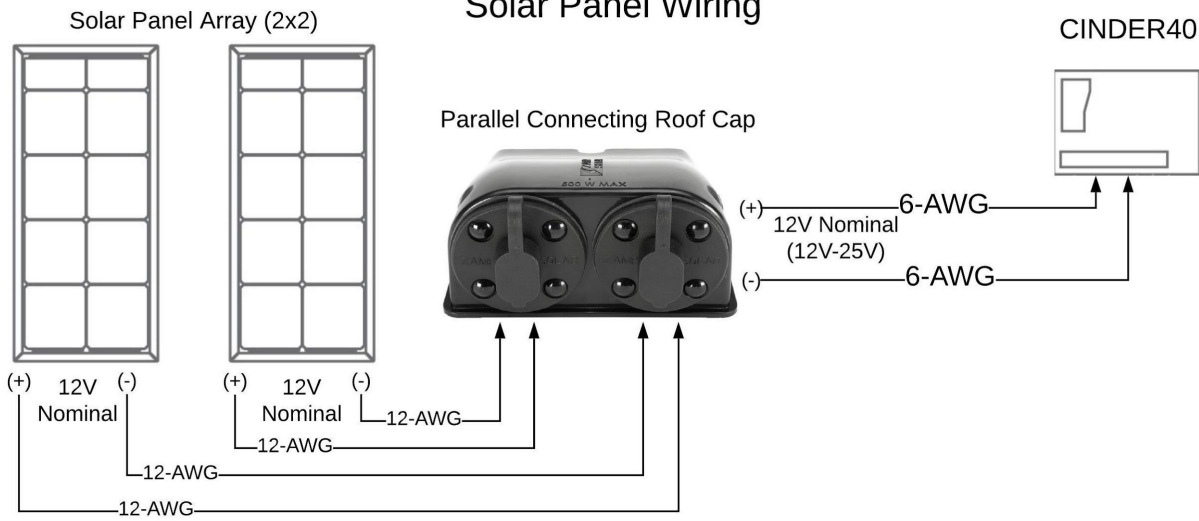

Figure 6: 12-Volt Charge Controller to Solar Panel Wiring example

Figure 6 demonstrates how to connect two panels in parallel using a Zamp solar parallel connecting roof cap to create a 12-volt charging system. This configuration should be used when your battery is 12-volts. Please see the Device Connections Section above for a description of all the Cinder 40 inputs to help you during installation.

24-Volt Installation Specifics

Table 2: 24-Volt Installation Quick information

Maximum Nominal Panel Wattage	1600W (<= 40A I _{sc})
Battery to Charge Controller Wire Size	6-AWG
Battery to Charge Controller Fuse Size	50A
Battery to Charge Controller Maximum Wire Length with 6-AWG	20 Ft
Solar Panel to Charge Controller Wire Size	6-AWG
Solar Panel to Charge Controller Maximum Wire Length with 6-AWG	20 Ft
Solar Panel Configuration	2x12V panels in Series or 24V Panel
Temperature Sensor	Tape to top or side of the Battery if lead acid
Load Output Voltage	24V
Load Output Current	20A

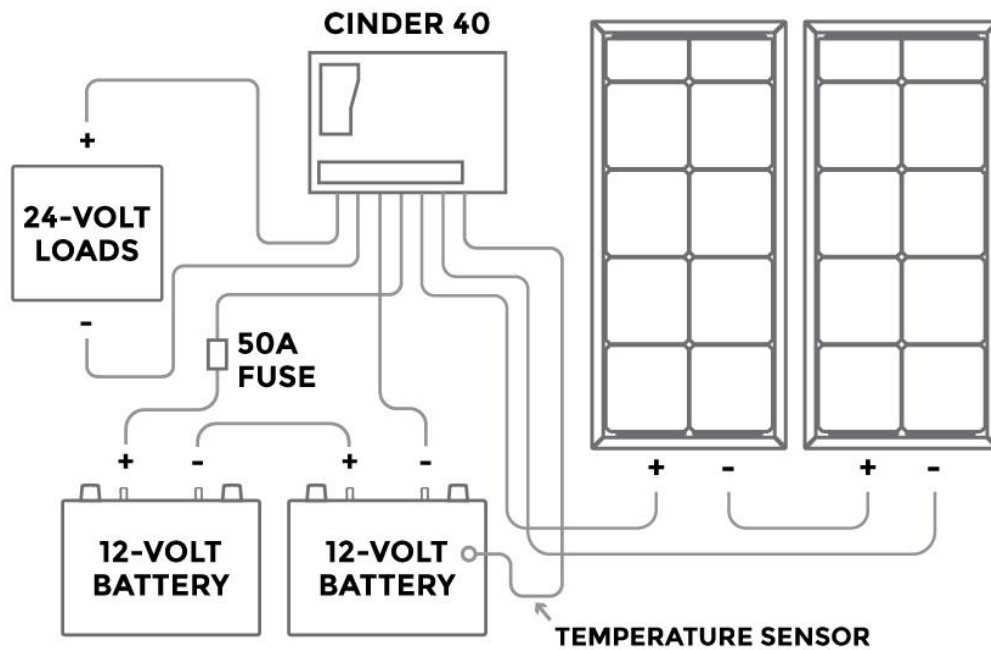

Figure 7: 24-Volt Installation

24-Volt Charge Controller to Solar Panel Wiring

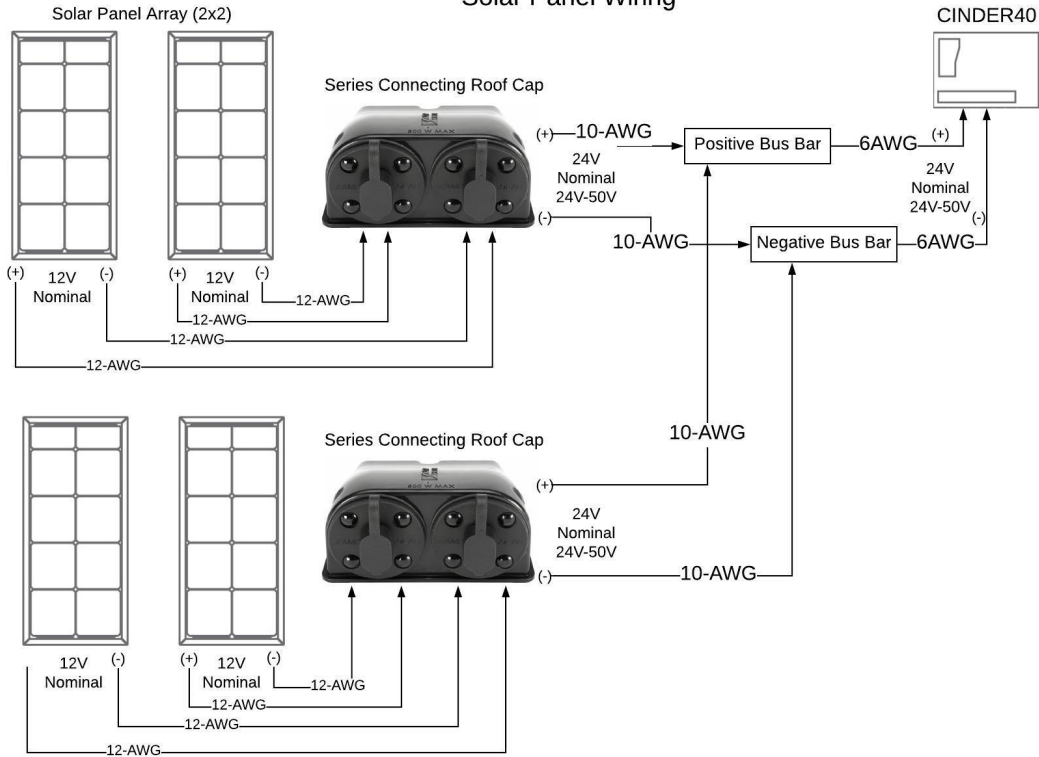

Figure 8: 24-Volt Charge Controller to Solar Panel Wiring example

Figure 8 demonstrates how to connect 4 panels in a 2x2 series configuration using Zamp solar series connecting roof caps to create a 24-volt charging system. This configuration should be used when your battery is 24-volts. Please see the Device Connections Section above for a description of the CINDER 40 inputs and outputs.

Load Output Circuit Details

Description

The load terminals give a user-controlled, 20-amp, fuse protected output circuit that discharges from the battery. The Zamp Solar app allows you to turn your load on/off as well as monitor the load output at all times so you can see how much power is being used by your attached electronics.

The load terminals will automatically turn off when the CINDER 40 senses that your battery system has dropped below the “Load Disconnect Voltage” to protect your battery from discharging too far (see the [Settings Page](#) for more information on the “Load Disconnect Voltage”)

IMPORTANT: The load voltage matches the battery voltage. Ensure that your electronics match your battery voltage. i.e. DO NOT connect 12-volt electronics to the load if your battery voltage is 24-volt.

Examples

The best use of the Load is to connect LED lighting to these terminals so that you can turn on/off your lighting with the Zamp Solar App.

These terminals could also be run to a DC fuse block to run other devices such as LED light bars, fans, USB chargers, refrigerators, heaters, small water pumps and other battery driven devices. Ensure that the total current of your loads does not exceed 20-amps.

IMPORTANT: It is very important that you do NOT connect your inverter to these terminals. Inverters require significant start up current that can cause damage to the device. Keep in mind that the circuit can only handle 20 amps at one time. If you have a device that should never turn off regardless of the battery voltage, connect this device directly to the battery instead of through the load circuit.

Load Wiring Recommendations

Please see the chart below for information on recommended wire gauge size for the load terminals. Please note that these recommendations assume that the wires connected are carrying the full 20A load output and keeping the voltage drop below 5%. Note: it is recommended to use larger wire as there will be less power loss in the wires.

Table 3: Load Wiring Recommendations (for a Maximum 20-amp Load Current)

Length of Wire Run	Wire Size to Use
5 Ft	10 AWG or larger
10 Ft	10 AWG or larger
15 Ft	10 AWG or larger
20 Ft	8 AWG or larger
25 Ft and greater	8 AWG or larger

5) Zamp Solar Mobile Application

Find the Zamp Solar App on the Google Play Store or on the iOS App Store by searching "Zamp Solar".

The CINDER 40 PWM controller can be controlled using the Zamp Solar application available on both Android and iOS devices.

There are three main pages in the application:

- Status
- History
- Settings

These allow you to view important information about the status of your device and to change the way it behaves. Each app page is shown below. See the following three pages for a detailed description of each page.

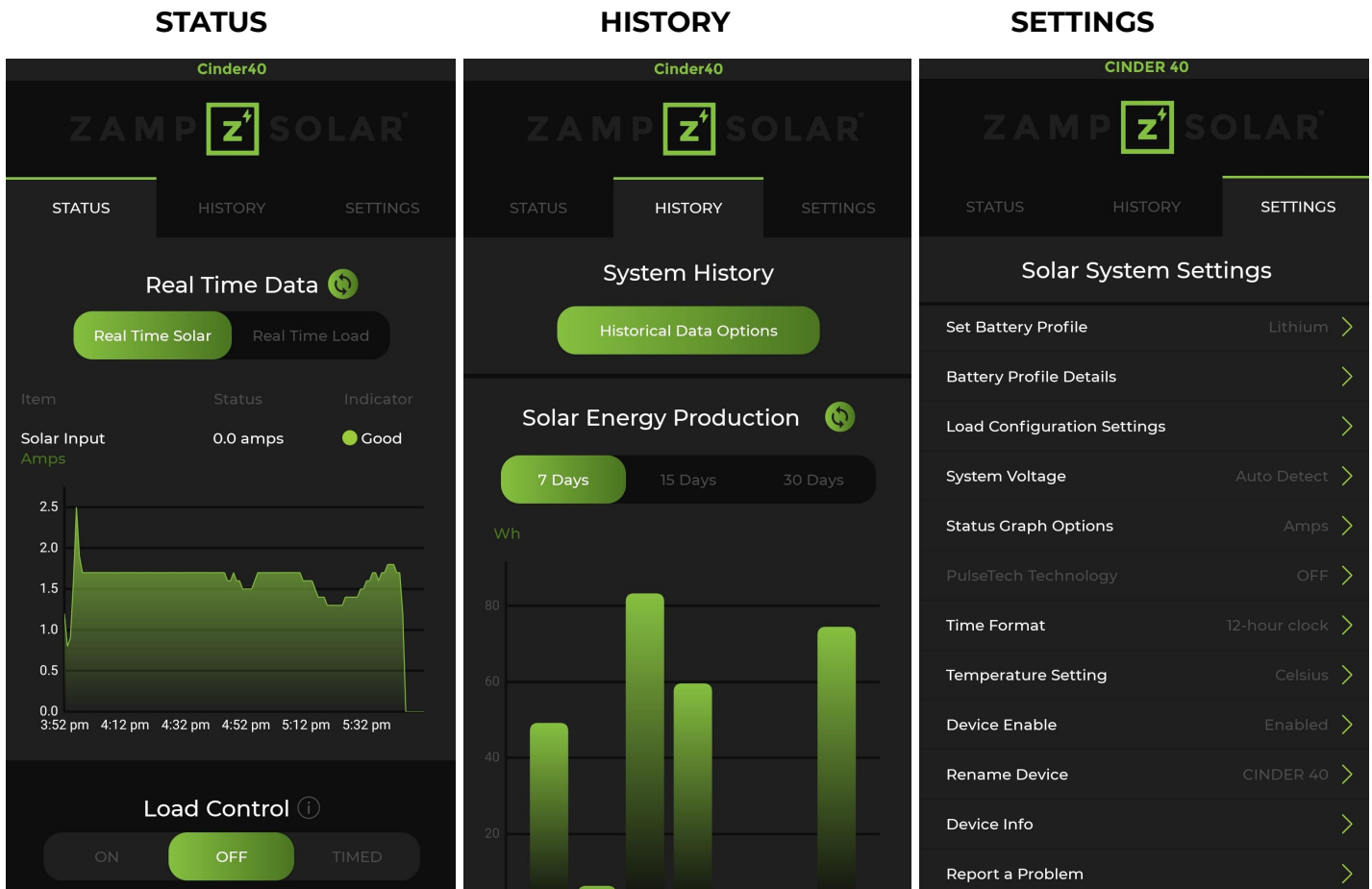

Figure 9: 3 Main App Screens (Status, History and Settings)

Status Page

- **Real Time Data**

Graph Select Buttons: These two buttons are labeled “Real Time Solar” and “Real Time Load”. The option that is highlighted in green will be displayed below on the graph.

Solar Input: This value gives either the real time current in amps or the real time power in watts from the solar panels depending on your settings for the real time status graph. This value will always be shown even if the Real Time Load option is selected for the graph. See Table 4 below for a description of the indicator next to this value.

Real Time Graph: This graph shows solar input data or load output data over the last 2 hours. The graph will automatically scale its vertical axis to the highest value.

- **Load Control**

ON: turns the Load output circuit on until it is turned off.

OFF: turns the Load output circuit off.

TIMED: allows you to turn on the load for a defined time range (e.g. 8AM - 8PM)

- **Load Disconnect Voltage**

If the battery voltage drops below this value, the load will disconnect in order to preserve the health of the battery. It can be set to any value between 10.2V ~ 12.6V for 12V systems (20.4V ~ 25.2V for 24V systems).

- **Load Output Current**

Gives real time current going from the battery through the load terminals in amps.

- **Real Time Information**

Battery Voltage: Shows the real time voltage of the battery in volts. See Table 4 below for a description of the indicator.

Battery Temperature: Shows the temperature of the battery taken from the external temperature sensor. The app will show “not connected” if the external temperature sensor is not connected. Change from C to F in the settings under “Temperature Setting”. See Table 4 below for a description of the indicator.

Charging Current: Shows real time solar current in amps going to the battery from the solar input. See Table 4 below for a description of the indicator next to this value.

Solar Wattage: Shows real time solar wattage going to the battery from the solar input. See Table 4 below for a description of the indicator next to this value.

Solar Voltage: Shows real time solar voltage of the solar input. See Table 4 below for a description of the indicator next to this value.

System Voltage - This shows the nominal system voltage (either 12V or 24V). If this value does not match your nominal battery voltage adjust this value in the settings under “System Voltage”.

Charge Profile - This shows the current battery profile being used by the system to charge the battery. This can be changed in the settings under “Battery Profile”.

Charge State: This shows the current charging state of the controller. The state can be any of the following: Start, Soft, Bulk, Absorption, Float or Idle

PulseTech: This shows if the PulseTech Pulsing Technology is active or not.

Status Indicator Light Descriptions**Table 4: Status LED Descriptions**

Indicator LED Status	Bulk/Soft (CC)	Absorption/Float (CV)	Idle/Start
Solar Input (Charging Current) Green	<=40A		<0.3 A
Solar Input (Charging Current) Red	>40A OR Negative Current		>0.3A OR Negative Current
Battery Temp Green	-15°C~32°C		
Battery Temp Yellow	-20°C~-15°C or 32°C~37°C		
Battery Temp Red	<-20°C or >37°C		
Battery Voltage Green	<ul style="list-style-type: none"> 12V: 11.8V~Absorption Voltage 24V: 23.6V~Absorption Voltage 		
Battery Voltage Yellow	<ul style="list-style-type: none"> 12V: 8V~11.8V or Absorption Voltage~16V 24V: 16V~23.6V or Absorption Voltage~32V 		
Battery Voltage Red	<ul style="list-style-type: none"> 12V: <8V or >16V 24V: <16V or >32V 		
Solar Wattage Green	If both Solar Voltage and Solar Current are Green		
Solar Wattage Yellow	If one or both of Solar Voltage and Solar Current are Yellow		
Solar Wattage Red	If one or both of Solar Voltage and Solar Current are Red		
Solar Voltage Green	If Charging <ul style="list-style-type: none"> 12V: Solar Voltage~23V 24V: Solar Voltage~46V "Solar is not connected" = yellow	<ul style="list-style-type: none"> 12V: 10V~28V 24V: 30V~50V 	
Solar Voltage Yellow	If Charging <ul style="list-style-type: none"> 12V: <Solar Voltage or 23V~50V 24V: <Solar Voltage or 46V~50V "Solar is not connected" = yellow	<ul style="list-style-type: none"> 12V: <=10V or 28V~50V 24V: <30V "Solar is not connected" = yellow 	
Solar Voltage Red	<ul style="list-style-type: none"> 12V: >50V OR Negative Voltage 24V: >50V OR Negative Voltage 		

History Page

- **System History**

Historical Data Options: This button allows you to change the History graph to any of the following options:

- Solar Energy Production
- Max Daily Wattage
- Max Daily Amperage
- Wattage Average

- **History Graph**

The top buttons can change the time scale of the graph. This can be 7 days, 15 days and 30 days.

- **Records and Statistics**

Here you can view any of the following historical statistics:

- 10 Day Total Energy Generation (kWh)
- 30 Day Average Daily Energy Generation (Wh)
- Maximum Daily Energy Production (Wh)
- Highest Recorded Amperage (A)
- Average 10 Day Battery Percentage (%)
- Average 10 Day Battery Voltage (V)
- Average 24 Hour Battery Voltage (V)
- Average 24 Hour Wattage (W)
- Average 24 Hour Amperage (A)
- Lowest Battery Voltage (V)

Choose Records and Statistics - This button allows you to change the displayed Records and Statistics. The order in which these statistics are presented can also be adjusted here.

Settings Page

- **Set Battery Profile**

Select to change the active battery profile. It is very important that you set this profile to match your battery type. (See [Section 7](#) for a description of all the default profiles.)

Check your specific battery datasheet for recommended absorption and float voltages.

If the specific values of your battery differ from the default profile, create a customized profile one of the three Custom Profiles. Follow the steps below to create a custom profile.

1. Select an available custom profile.(1-3)
2. Choose a battery type to base this profile on that best matches your battery type.
3. You will then be taken to a screen where you can edit the absorption voltage and float voltage according to your battery spec sheet. The "Float" option allows you to enable or disable the float stage entirely.
4. Once your custom values match those given by your battery manufacturer, press "set" to enable your new custom profile.

- **Battery Profile Details**

Select to view the details of the active Battery Profile.
If Float is not active, then it will not appear in the details section.
- **Load Configuration Settings**

Load Disconnect Voltage: If the battery voltage drops below this value, the load will disconnect in order to preserve the health of the battery. This value can be adjusted from 10.2V ~ 12.6V for 12V systems (20.4V ~ 25.2V for 24V systems).
- **System Voltage**

This value is the nominal voltage of the battery you are charging. It is automatically detected by default but can be changed. Unless the system voltage value in the Real Time Battery Data section does not match your nominal battery voltage, do not change the system voltage.
- **Status Graph Options**

Select to change the Status Graph between Watts and Amps
- **PulseTech Technology**

Select to turn the PulseTech Pulsing Technology on or off (see [Section 6](#) for a description of this function)
For all Lithium-based profiles this option will be greyed out because PulseTech cannot be used with Lithium batteries.
- **Time Format**

Select to change between 12-hour and 24-hour clock formats.
- **Temperature Setting**

Select to change the displayed temperature between Fahrenheit and Celsius.
- **Device Enable**

Device Enable State: If enabled is selected, the device will run as normal. If disable is selected, the device will stop all charging until enable is selected. When disabled, the CINDER 40 will slowly blink the battery LED orange.
Default Device Enable State: This field determines what the Device Enable State will be when the device is started or restarted.
- **RV-C**
 - Select Enable to enable RV-C Communication capabilities
 - NOTE: If not actively using RV-C, it is recommended to keep this disabled to reduce self-consumption
- **Rename Device**

Select to change the name of the device as it appears on your App. The name you select must be 10 characters or less.
- **Device Info**

Select for a description of the App and Firmware versions of the device. Update device firmware by following instructions on the next page.
- **Report a Problem**

Select to send an email to our developers describing the issue.

Updating Device Firmware

If you need to update the Device Firmware (FW) for any reason, follow the instructions below.

- Use the Zamp Solar App to connect to your CINDER 40
- Navigate to the Settings Page
- Click “Device Info”
- Click “Check FW Version”
- If a new update is available, install it.
- If the update has begun successfully, all LEDs except the Blue Bluetooth LED will turn off.
- Ensure that you keep your phone close to the CINDER 40 device for the entirety of the update.

Note: The app will search for firmware updates when it first connects to the CINDER 40 and you will be alerted if there is an update available.

6) PulseTech Functionality

The CINDER 40 controller contains a proprietary, patented PulseTech pulsing circuit that has been scientifically proven to extend the life of all types of lead acid batteries. This is achieved using PulseTech's patented pulsing technology that breaks up the lead sulfates that build up on the plates inside the battery whenever the battery is discharging.

Sulfates negatively impact battery performance by:

- Reducing the battery's ability to discharge power
- Reducing the battery's ability to recharge
- Shortening battery life

Pulse Technology is delivered to the battery through a circuit which is independent of the charging circuit. This patented, high-frequency pulse waveform is of a specific amplitude and frequency that is precisely controlled by microprocessors. It rises rapidly in less than one microsecond to its maximum amplitude and gradually returns to zero. There is no abrupt stop and no battery drain. This waveform occurs 25,000 times a second and has been proven to remove sulfation from the battery plates and return the lead sulfate back to the electrolyte solution.

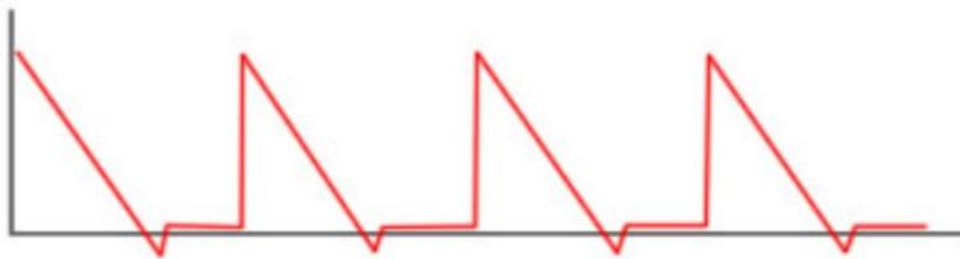

Figure 10: PulseTech Pulse Technology Waveform

For more detailed information, visit the website here:

<https://www.pulsetech.net/our-technology/pulse-technology.html>

The pulse circuit is applied on top of the charging waveform. Thus, the pulse circuit requires the device to be charging in order to function. The PulseTech Pulsing is automatically enabled on all Lead-Acid/AGM battery profiles and can be turned off in the settings. For all Lithium battery profiles, the PulseTech pulsing has been disabled to prevent damage to the battery management system (BMS).

7) Charging Profiles

The CINDER 40 contains six pre-programmed, multi-stage battery profiles that have been customized to each specific battery type. There are profiles for AGM, Gel, Conventional lead-acid (WET), Lithium (Lithium Ion & LiFePo₄), LTO (Lithium Titanate Oxide), and Calcium Batteries. If your battery requires specific voltages that do not match up with our predefined profiles, you can use one of the three available custom profiles. These profiles let you set your own absorption and float voltages to create a profile that works for your specific battery. See the following two pages for detailed descriptions of the different charging stages.

Table 5: Default Charging Profile Voltage and Current Descriptions

Default Charging Profile Voltage and Current Descriptions						
This table shows the 12V system voltage, double the voltage given for a 24V system						
	AGM (DEFAULT)	Gel	Calcium	Wet/Flooded	Lithium (LiFePo₄ / Li Ion)	LTO
Soft Charge voltage	3V - 10V				BMS Lower Cutoff - 10V (1)	
Soft Charging Current	4A (2A for 24V)					
Bulk Charge voltage	10V-Absorption Voltage					
Bulk Charge Current	Max current available up to 40A					
Absorption Charge voltage	14.6V	14.1V	14.9V	14.7V	14.2V	14.0V
Absorption to Float Condition	1. Charging current drops below 1A (or) 2. Charger has been in absorption mode for 4 hours					
Float Charge voltage	13.6V	13.3V	13.8V	13.4V	No Float	
Default Restart Charge Voltage	13.3V	13.0V	13.5V	13.1V	13.6V	13.0V
Pulsing Waveform Applied When is PulseTech Enabled	Apply pulse in defined waveform when solar power is available				Pulsing Circuitry not allowed	
Min ~ Max Charging Temperature with Sensor	-4°F ~ 113°F -20°C ~ 45°C	-4°F ~ 113°F -20°C ~ 45°C	-4°F ~ 124.7°F -20°C ~ 51.5°C	-4°F ~ 124.7°F -20°C ~ 51.5°C	The charger relies on the battery's internal BMS to shut off charging due to high or low temperatures	
Min ~ Max Charging Temperature without sensor	-4°F ~ 176°F (2) -20°C ~ 80°C (2)					
Temperature Compensation	- 30mV/°C for 12V - 60mV/°C for 24V				Do not use temperature sensor with Lithium Batteries	
Voltage Output Accuracy	+/- 0.1V					

(1) BMS systems should not ever allow the battery to discharge below 10V.

(2) This range is for the board temperature. Since no battery temperature sensor is connected, the device can only read the board temperature.

Table 6: Allowed Custom Charging Profile Voltage Ranges

Custom Charging Profile Voltage Ranges				
This table shows the 12V system voltage, double the voltage given for a 24V system				
Battery Type	Absorption Value Range Allowed	Float Voltage Range Allowed	PulseTech Pulsing Allowed?	Restart Voltage Range Allowed ⁽¹⁾
AGM	13.8V~15.0V	12.8V~14.0V	Yes	0.98*Float Voltage
Gel	13.8V~15.0V	12.8V~14.0V	Yes	0.98*Float Voltage
Flooded/Wet	13.8V~15.0V	12.8V~14.0V	Yes	0.98*Float Voltage
Calcium	14.0V~16.0V	13.0V~15.5V	Yes	0.98*Float Voltage
Lithium	13.5V~15.0V	Float not used	No	12.8V ~ 14.0V
LTO	13.0V~15.0V	Float not used	No	12.2V ~ 14.0V

- (1) If the battery voltage drops below the Restart Voltage, the controller begins bulk charging again. For AGM, GEL, Flooded/Wet and Calcium profiles, the device will always set the restart charge voltage to 0.98 * Active float voltage. Thus, if you change the float voltage in a custom profile, the restart charge voltage changes with it. For Lithium profiles, you may set the restart charge voltage within the range defined in the table.

8) LED Operation

Battery Status LED

This LED gives the current charging state of the controller.

Solid Green = Float/Fully charged

Fast Blinking Green = Absorption

Solid Orange = Bulk Charging

Slow Blinking Orange (once every 2 seconds) = Device Disabled

Solid Red = Soft Charging

Blinking Red = Battery Error

Off = No Battery Connected

Solar Status LED

This LED gives the current status of the connected solar array.

Green = Solar is present and >15V (>30V for 24V system)

Off = Solar is <15V (<30V for 24V system)

Load Status LED

This LED gives the current status of the Load.

Green = Load is on

Off = Load is off

Bluetooth LED

This LED gives the current status of the device's Bluetooth.

Solid Blue = Bluetooth connection active

Blinking Blue = Searching for Bluetooth connection

PulseTech LED

This LED gives the current status of the onboard PulseTech Pulsing Technology.

Blinking Red = PulseTech Pulsing Technology is active and pulsing

Off = Pulsing is off

NOTE: The LED will not always be on even if PulseTech is turned on in the App. The device determines when the proper time to Pulse is based on the current charge state of the battery.

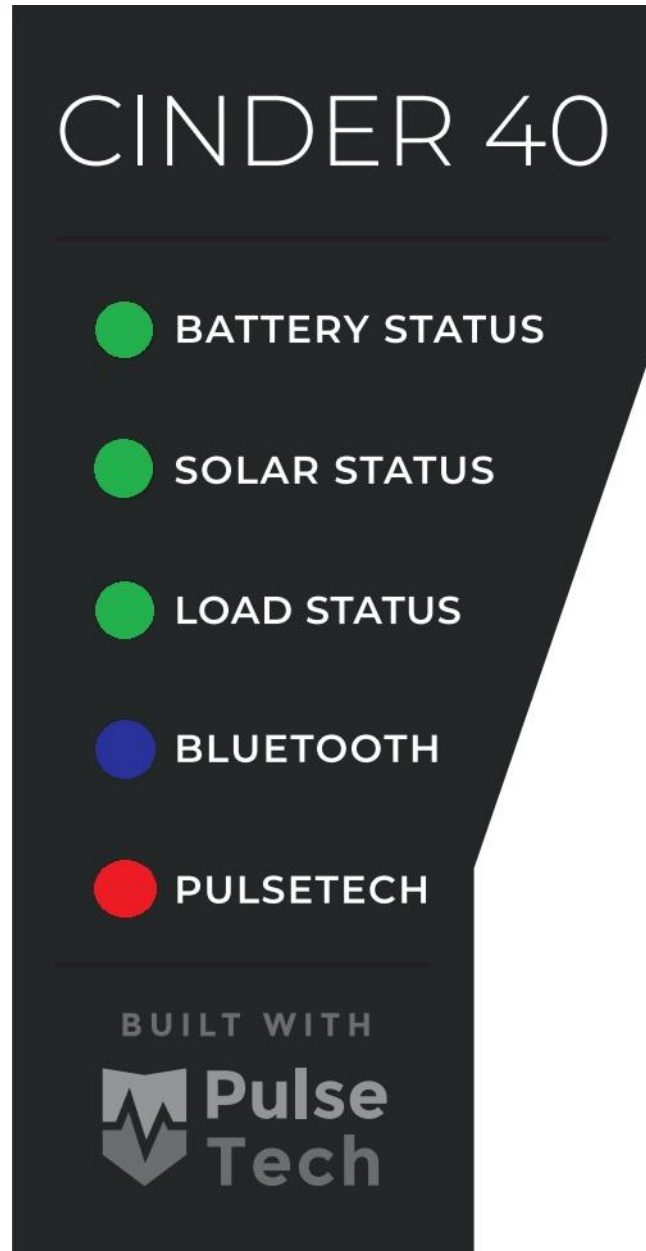

9) Troubleshooting

Battery Removal Procedure

If you are going to remove your battery during a period of very low Solar Input (i.e. nighttime, inside a shop with no lighting, etc.) you must also remove the solar panel input. If you remove the battery input and leave a weak solar input, the controller will consider its power source too variable and enter a shutdown state. This can be remedied by removing the solar input and re-attaching the battery input.

If you are removing your battery with plenty of solar input (i.e. any condition where the sun is present) you may disconnect your battery freely without removing the solar input. It is important that you reconnect the battery before the sun goes down to avoid exposing the controller to very weak solar input.

Controller “blinking orange and green”

If you are looking at the front face of your CINDER 40 Charge controller during dusk or dawn, you may observe that the battery status light is switching quickly between green and orange. This may look like an error, but it is not. The two colors of the LED represent 2 charging states that are being encountered quickly due to the behavior of the charger. Orange occurs when the device enters Bulk mode in an attempt to charge using the available sun. Since the sun is weak during dusk and dawn, there is not sufficient current to cause the device to continue charging and thus it enters an idle state which is represented by a green color on the battery status LED. Since the solar controller always wants to be in a charging mode, the device will then reattempt charging and the LED will turn orange again and begin the cycle all over. This orange-green LED blinking is normal controller behavior and nothing to worry about.

Controller is “buzzing” and making noise

You may notice that the Cinder 40 occasionally makes a buzzing noise during charging. This is normal. This buzzing will typically only occur during Float/Absorption modes and indicates that the charger is limiting the current to your battery as it proceeds through its normal three stage charging process.

Controller is blinking orange on the battery status LED and not charging a battery

This blinking orange on the battery status LED indicates that the device is in the RV-C disable state. Please go to Settings->Device Enable and select “Enabled” under the “Device Enable State” field to re-enable your controller and resume charging.

10) Specifications

Table 9: Specifications for CINDER 40

Specification	Details
Battery Voltage	12/24V (Automatically Detected)
Minimum Voltage on Battery Terminals	3V
Maximum Voltage on Battery Terminals	40V
Rated Charge Current	40A
Minimum Solar Input Voltage to Charge	12V Battery: 15V 24V Battery: 30V
Maximum Open Circuit Solar Panel Voltage	50V (recommended <28V for 12V)
Maximum PV short circuit Current ⁽¹⁾	45A (<=40A Recommended)
Maximum Nominal Solar Panel Wattage	12V: 800W 24V: 1600W
Self-Discharge Current	12V battery: 100mA 24V battery: 75mA
Protection	Reverse polarity at solar input Reverse polarity at battery input Protection against reverse current from battery to solar Load terminal short circuit protection (internal fuse) Over temperature protection
Input Terminals	2-AWG maximum screw terminals for solar input 2-AWG maximum screw terminals for Battery input 2-AWG maximum screw terminals for Load output External Temperature Sensor Input RJ-45 Connectors allow RV-C connectivity ⁽²⁾
Load Terminal Current Output Max	20A Max ⁽³⁾
Load Terminal Low Voltage Disconnect ⁽⁴⁾	11.8V (Adjustable)
Humidity (non-condensing)	Max 98%
Battery temperature sensor	Included with Device Tape to Battery for accurate temperature compensation during charging
Discharging Temperature Range	-4°F ~ 140°F -20°C to +60°C
Protection Category	IP22
Weight	1.43 lb/0.65 kg (includes temperature sensor)
Dimensions (h x w x d)	5.57" x 7.93" x 2.31" (141.4mm x 201.5mm x 58.7mm)
Standards	ETL tested to UL 1741

⁽¹⁾ Overcurrent protection set at 45-amperes for the Cinder 40. PV short circuit current above this value may damage the device.

⁽²⁾ For information on RV-C please see contact us. See [Section 11](#) for contact information.

⁽³⁾ Fuse protected at 25-amperes

⁽⁴⁾ This is the battery voltage at which the Load will stop delivering current. This setting prevents excessive battery discharge.

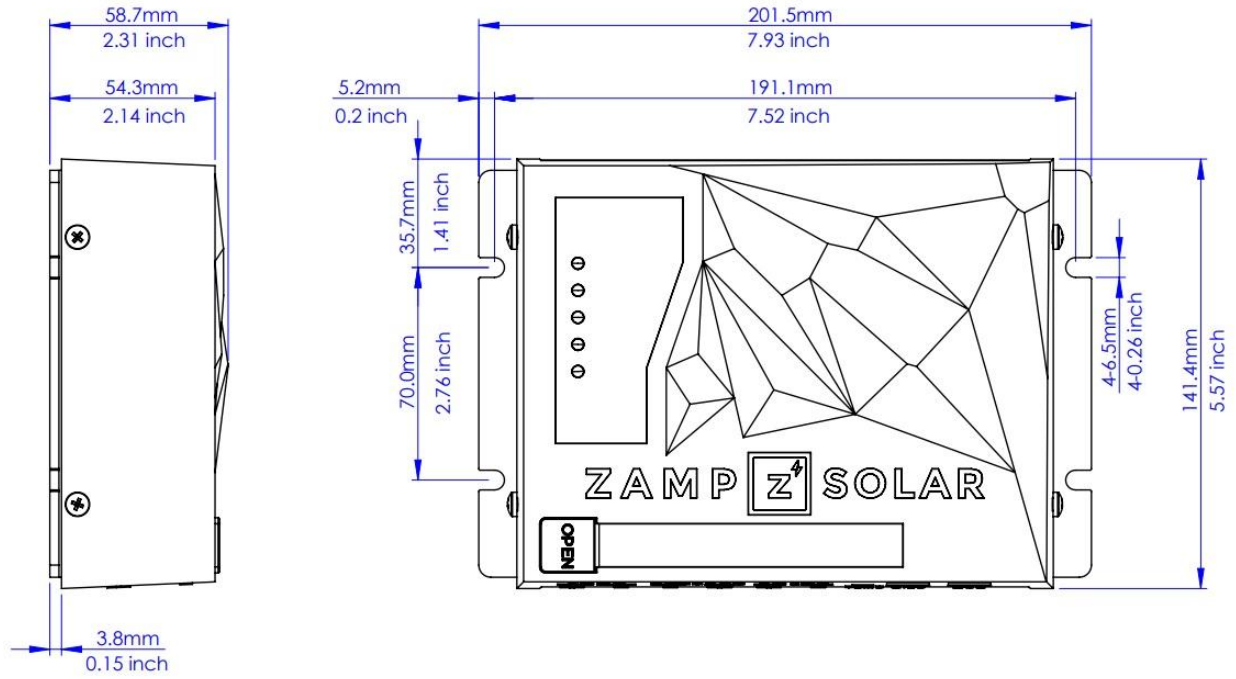

Figure 3: CINDER 40 Mounting Diagram

11) Contact Us

Zamp Solar
62355 NE Jamison Street
Bend, OR 97703
support@zampsolar.com
www.zampsolar.com
Phone: 541-728-0924