



# 2023-US Catalog for indoor Light



[www.aaledlighting.com](http://www.aaledlighting.com)

# Contents

# indoor Light



01-HBG2



02-HBG3



03-HBG4



04-HBO



05-LHBD

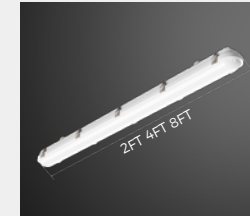

06-VPA

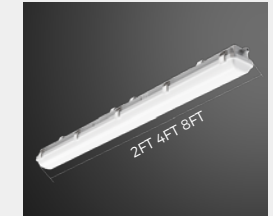

07-VPA Plus

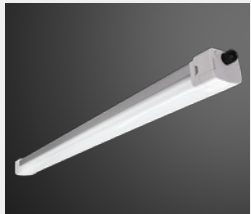

08-VPE



09-LSC



10-LSD



11-LSA

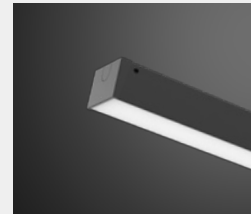

12-Nexus



13-Lambert



14-Flexible



15-Slender



16-BPL

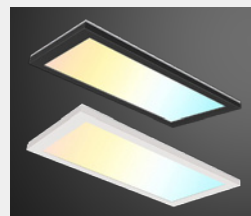

17-IPN



18-Oval32"



19-CP



20-FMB

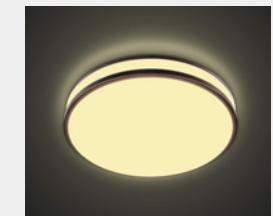

21-FMC



22-Gimbal



23-DLE



24-DLD

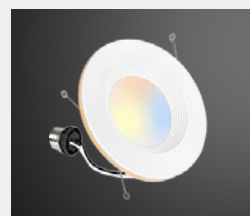

25-DLA

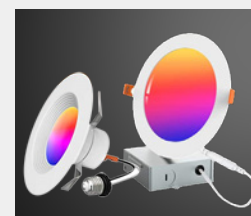

26-DLD-W & DLA-W

# LED HIGH BAY LIGHT



01

HBG2



02

HBG3



03

HBG4



04

HBO



05

LHBD

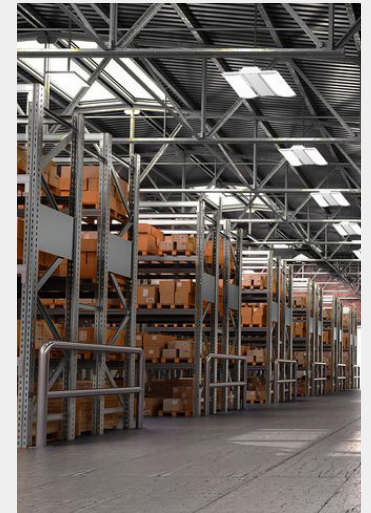
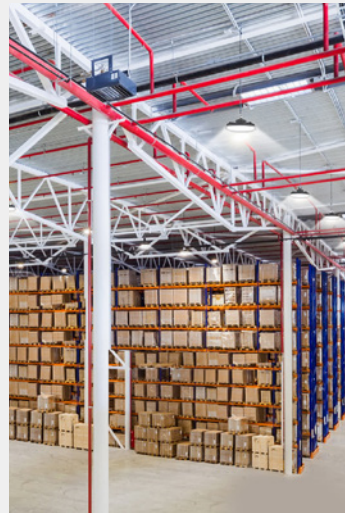
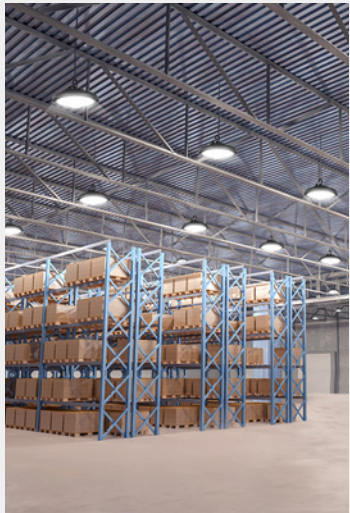

# HBC2

## LED High Bay Light

- DLC 5.1 Premium Listed
- ETL, cETL, Listed
- High Lumens 160lm/w, 200lm/w
- IP65 Wet Location
- Multi-Voltage: 100-277/347V/480V
- 0-10V dimming in standard
- 5 Years warranty

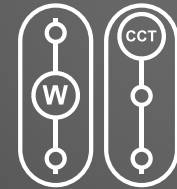

## Distribution

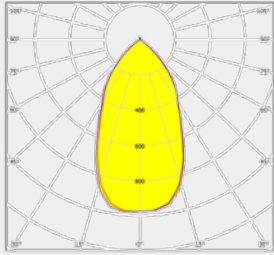

60° Lens

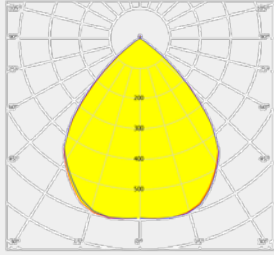

90° Lens

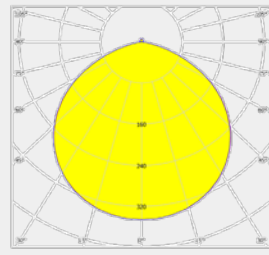

120° Lens

## 3-Power and 3-CCT Switchable

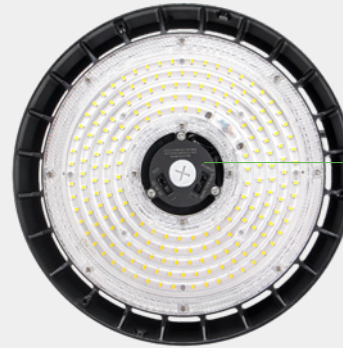

## Different lens options



Annular lens 60°/90°/120°



Arch lens 120°



Dome Cover 120°

## Plug & Play Sensor Function



Empty Cover  
(No Function)  
(can be pre-install)

Plug & Play  
Sensor Cover



Remote Control  
for resetting Sensor  
data or dimming

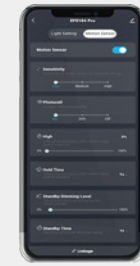

App Control  
 Bluetooth®



Wall Switch  
(Remote Control)  
 Bluetooth®

## Parameter

Model No.	Power	Input	LEDs	Efficacy	Lumens	Ra	Beam Angle	CCT	Control
HB-100G	100W-80W-60W	100-277V/347V	2835	160/200LM/W	16000/20000LM	>80/70	60° 90° 120°	Single color or 3-CCT Switchable	0-10V DALI Sensor Bluetooth
HB-150G	150W-100W-80W	100-277V/347V	2835	160/200LM/W	24000/30000LM	>80/70			
HB-200G	200W-150W-100W	100-277V/347V	2835	160/200LM/W	32000/40000LM	>80/70			
HB-240G	240W-200W-150W	100-277V/347V	2835	160/200LM/W	38400/48000LM	>80/70			
HB-300G	300W-240W-200W	100-277V/347V	2835	160/200LM/W	48000/60000LM	>80/70			

## Smart Function optional





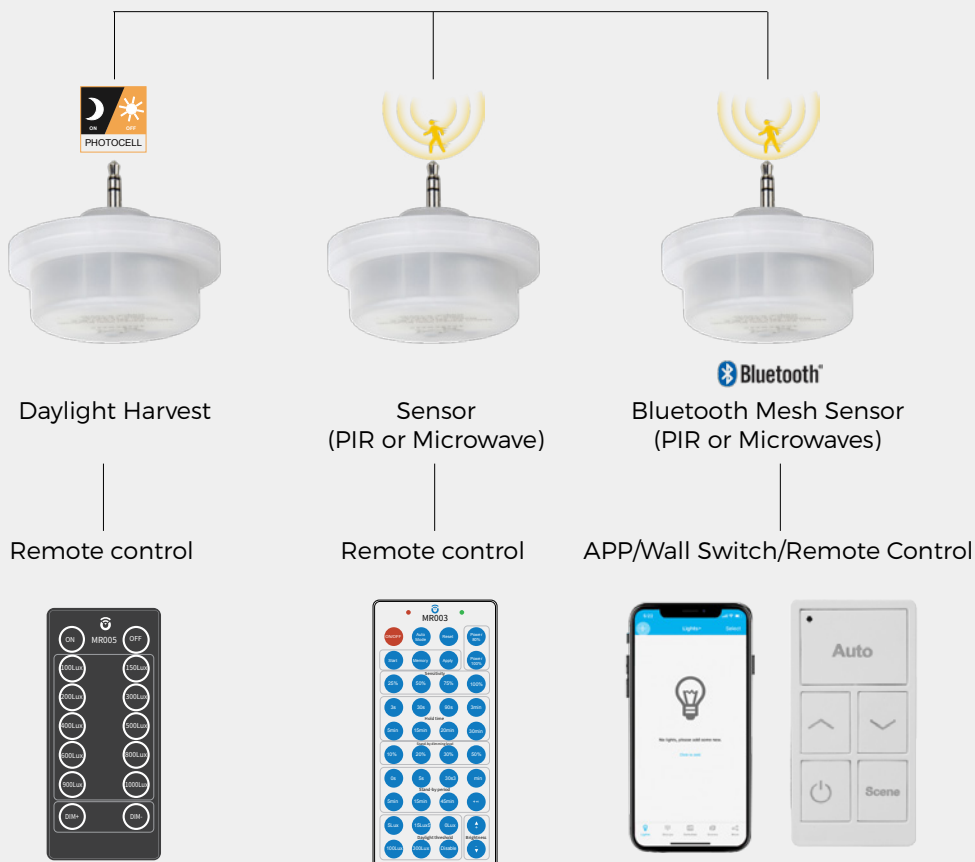



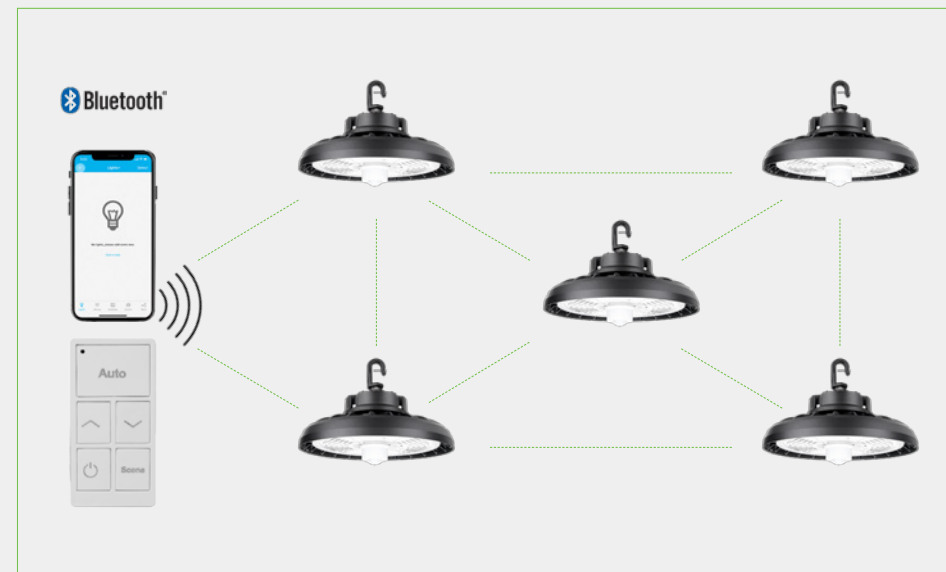

Plus & Play different cover for different function



## Bluetooth SIG Mesh Sensor and dimming Control



-  **Wireless Bluetooth SIG Mesh** between 30M/100FT  
Distance of two Fixtures.
-  **Group control**, Support 100pcs in one Group.
-  **Schedule and Timer**, like 9:00AM ON, 18:00 OFF.
-  **Scene Setting**, like meeting, working etc.
-  **Motion Sensor and Daylight harvest options**, automatically turn on, turn off and dim the lights.
-  **Linkage**, other lights in the same group detects movement, and the linkage is turned on in this group, then this light will dim to linkage light level.
-  **Wireless Control and no need Hub**
-  **APP System** is Easy to operated

# HBC3

02/

## LED High Bay Light

- DLC 5.1 Premium Listed
- ETL, cETL Listed
- Luminous Efficacy 150-200lm/w
- IP65 Wet Location
- Multi-Voltage: 100-277/347V
- 0-10V dimming in standard
- 5 Years warranty



## Distribution

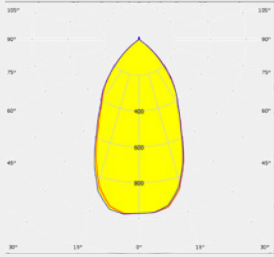

60° Lens

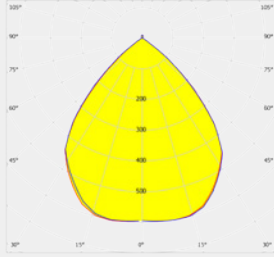

90° Lens

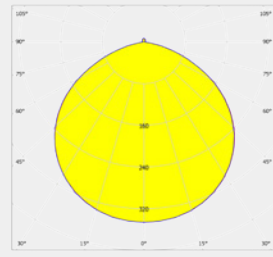

120° Lens

## Reflector optional



## Bracket optional



## Dimension

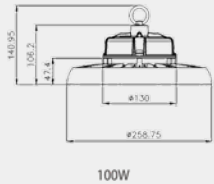

100W

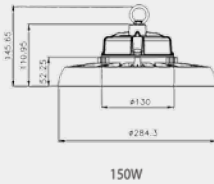

150W

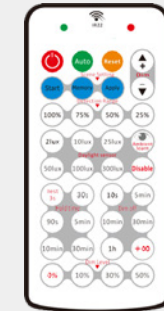
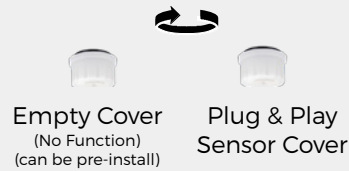
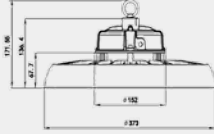
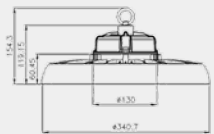

Remote Control available

## Parameter

Model No.	Power	Input	LEDs	Efficacy	Lumens	Ra	Beam Angle	CCT	Control
HB-100G3	100W	100-277V/347V	2835	150/200LM/W	15000/20000LM	>80	60° 90° 120°	3000K 4000K 5000K 5700K	0-10V Sensor
HB-150G3	150W	100-277V/347V	2835	150/200LM/W	22500/30000LM	>80			
HB-200G3	200W	100-277V/347V	2835	150/200LM/W	30000/40000LM	>80			
HB-240G3	240W	100-277V/347V	2835	150/200LM/W	36000/48000LM	>80			



# HBC4

## LED High Bay Light

- 4-Power & 2-CCT switchable
- High lumens 160lm/w, 200lm/w
- High quality driver, CHANGHONG Brand(GE and Osram Supplier)
- 6KV/10KV Surge protection
- 0-10V dim in standard
- Pre-install Sensor Socket, plug & Play Sensor cover



03/

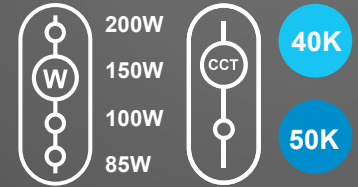

Plug & Play Sensor

## Distribution

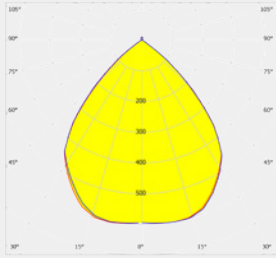

90° Lens

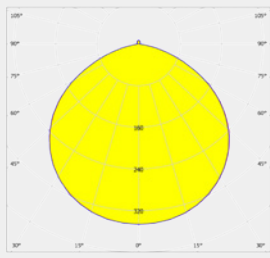

120° Lens

## Emergency version

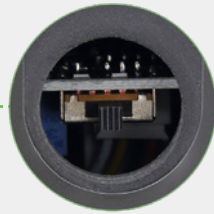

Emergency Power Switchable 30W-20W-15W

## Product Features

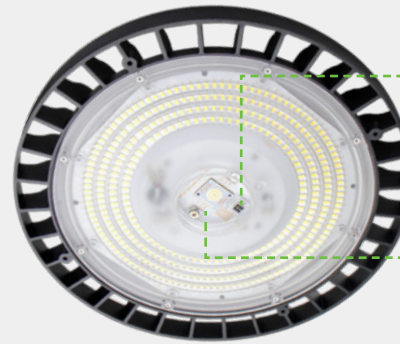

4-Power Switchable

	ON	ON	OFF	OFF	200W
	ON	OFF	OFF	ON	150W
	OFF	ON	ON	OFF	100W
	OFF	OFF	ON	ON	85W

2-CCT Switchable

	ON	Low color temperature
	OFF	High color temperature



Bayonet

Microwave sensor cover(Plug & Play)

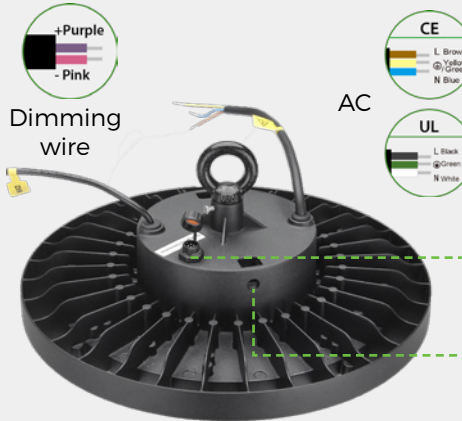

Dimming wire

AC

**High Quality driver** CHANGHONG

- OEM by CHANGHONG which is the driver supplier for OSRAM and GE Lighting
- Surge protection: 6KV/4KV
- Short circuit protected (SCP)/Overvoltage protection(OVP)/Over temperature protection(OTP);
- 0-10V DIM to OFF and PWM,
- auxiliary power supply 200MA 12V for Microwave Sensor

Reserved emergency power interface (options)

The hole to fix bracket

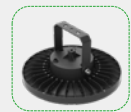

## Parameter

Model No.	Power	Input	Efficacy	Lumens	Ra	Beam Angle	CCT	Control
HBG-200W-xxK90	200W-150W-100W-85WSwitchable	90-305VAC	160LM/W	32,000LM	>80			
HBG-200W-2CK90	200W-150W-100W-85WSwitchable	90-305VAC	160LM/W	32,000LM	>80	90° 120°	single color or CCT switchable	0-10V Sensor
HBG-200W-xxK90	200W-150W-100W-85WSwitchable	90-305VAC	180LM/W 200LM/W	36,000LM 40,000LM	>80 >70			

# HBO

## LED High Bay Light

- NSF approval for food industries
- No Toxic Chemicals in Material
- No glass and no exposed screws
- IP69K hot steam scouring
- IP66 Smooth Body, make cleaning work easily



04/



## Distribution

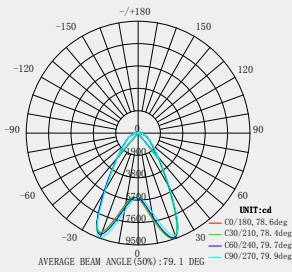

60° Lens

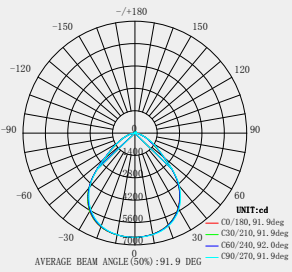

90° Lens

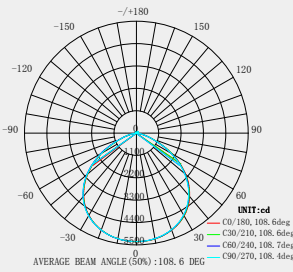

120° Lens

## Advantage

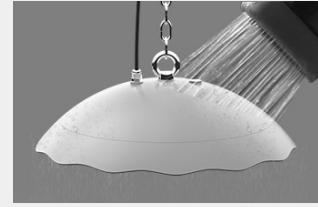

Seamless Design  
Diminished dust and  
easy to clean



IP69K Hot Steam Scouring  
Steam cleaning protection  
of water pressure at 100  
bar (1450 psi) /80°C



No Glass  
No Exposed Screws  
No Toxic Chemicals

## Dimension

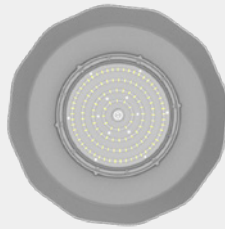

## NSF approval for food industries



## Parameter

Model No.	Power	Input	LEDs	Efficacy	Ra	Beam Angle	CCT	Control
HBO-100W	100W	100-277/277-480V	3030	135LM/W	>80			
HBO-150W	150W	100-277/277-480V	3030	135LM/W	>80	60° 90° 120°	3000K 4000K 5000K 5700K	0-10V Dim
HBO-200W	200W	100-277/277-480V	3030	135LM/W	>80			
HBO-240W	240W	100-277/277-480V	3030	135LM/W	>80			

# LHBD

## LED High Bay Light

- DLC 5.1 Premium Listed
- High Lumens 140lm/w with well-distributed and soft light.
- 3-Power & 3-CCT DIP Switchable
- Sensor and Bluetooth Mesh optional
- Lifespan L80>100,000 Hours
- Multi-Voltage: 100-277/347Vac with 0-10V Dim



05/

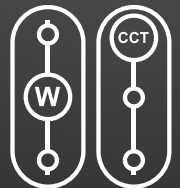

## Distribution

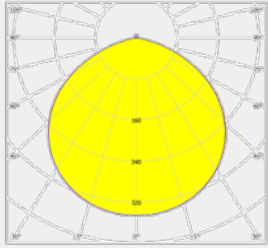

120° Lens

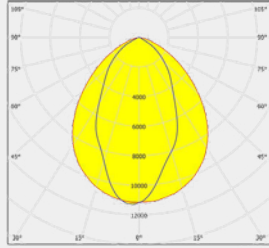

40x110° Lens

## 3-Power & 3-CCT Selectable



3-Power & 3-CCT

## Dimension

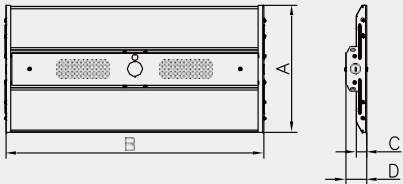

Power	A	B	C	D
80W	11.81"	23.62"	0.91"	1.87"
110W	11.81"	23.62"	0.91"	1.87"
165W	11.81"	23.62"	0.91"	1.87"
220W	14.17"	23.62"	0.91"	1.87"
300W	14.17"	35.10"	0.91"	1.87"

## Engineering Drawing

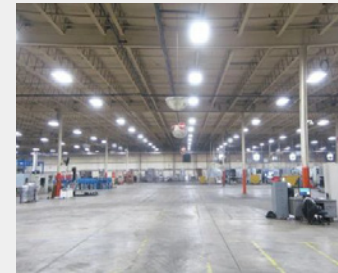

Factory



Warehouse

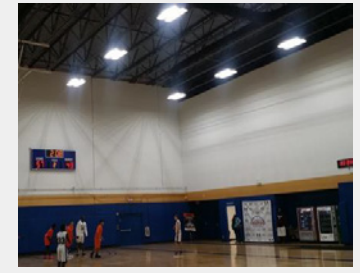

Gym

## Parameter

Model No.	Power	Input	Efficacy	Lumens	Ra	CCT	Beam Angle	Control
LHBD-L2-110W-XXK	110W/80W/60W Selectable	120-277/347/480V	140LM/W	15400LM	>80	4000K 5000K	120° or 40x110°	0-10V Dim Sensor Bluetooth Emergency
LHBD-L2-165W-XXK	165W/110W/80W Selectable	120-277/347/480V	140LM/W	23100LM	>80			
LHBD-L3-220W-XXK	220W/165W/110W Selectable	120-277/347/480V	140LM/W	30800LM	>80	3500K 4000K 5000K Selectable	120° or 40x110°	0-10V Dim Sensor Bluetooth Emergency
LHBD-L6-300W-XXK	300W/220W/165W Selectable	120-277/347/480V	140LM/W	42000LM	>80			
LHBD-165/110/80W-H-TCP(345)	165W/110W/80W Selectable	120-277/347/480V	140LM/W	23100LM	>80			
LHBD-220/165/110W-H-TCP(345)	220W/165W/110W Selectable	120-277/347/480V	140LM/W	30800LM	>80	3500K 4000K 5000K Selectable	120° or 40x110°	0-10V Dim Sensor Bluetooth Emergency
LHBD-300/220/165W-H-TCP(345)	300W/220W/165W Selectable	120-277/347/480V	140LM/W	42000LM	>80			

## Smart Function optional



Plus & Play different cover for different function



Daylight Harvest

Remote control

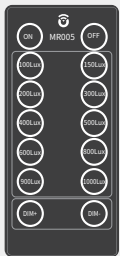

Sensor  
(PIR or Microwave)

Remote control



Bluetooth  
Bluetooth Mesh Sensor  
(PIR or Microwaves)

APP/Wall Switch/Remote Control



## Bluetooth SIG Mesh Sensor and dimming Control

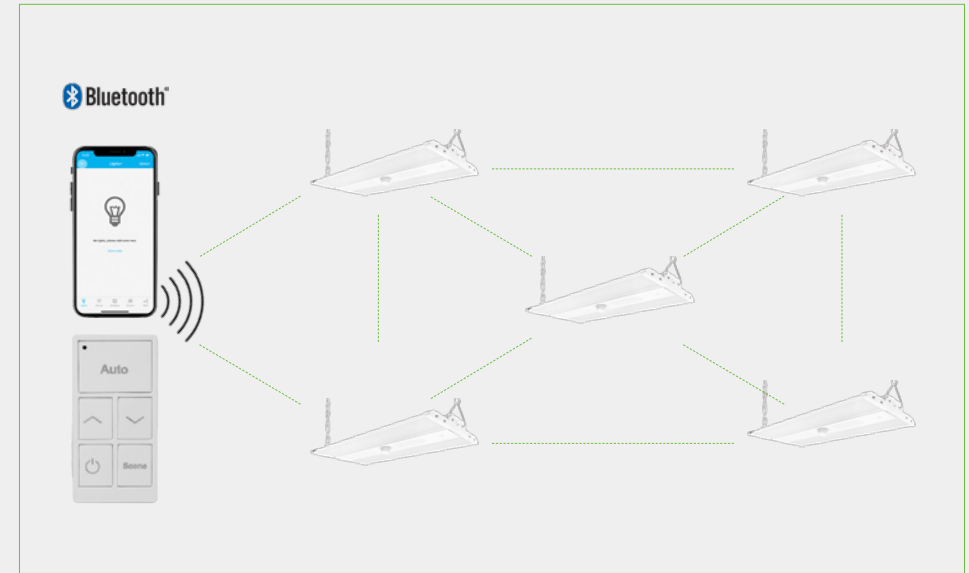

**Wireless Bluetooth SIG Mesh** between 30M/100FT  
Distance of two Fixtures.



**Group control**, Support 100pcs in one Group.



**Schedule and Timer**, like 9:00AM ON, 18:00 OFF.



**Scene Setting**, like meeting, working etc.



**Motion Sensor and Daylight harvest options**, automatically turn on, turn off and dim the lights.



**Linkage**, other lights in the same group detects movement, and the linkage is turned on in this group, then this light will dim to linkage light level.



**Wireless Control and no need Hub**



**APP System** is Easy to operated

# Vapor Tight Light Fixture

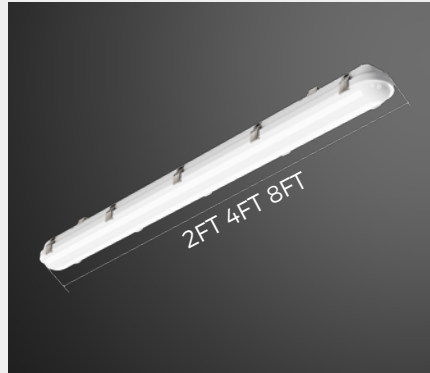

06

VPA



07

VPA Plus



08

VPE





# VPA

## Vapor Tight Fixture

- 2FT, 4FT, 8FT available
- 3-CCT Switchable
- 3 Watts Switchable
- 100-277V/ 347V available
- 0-10V dimming in standard
- ETL DLC Premium



2FT

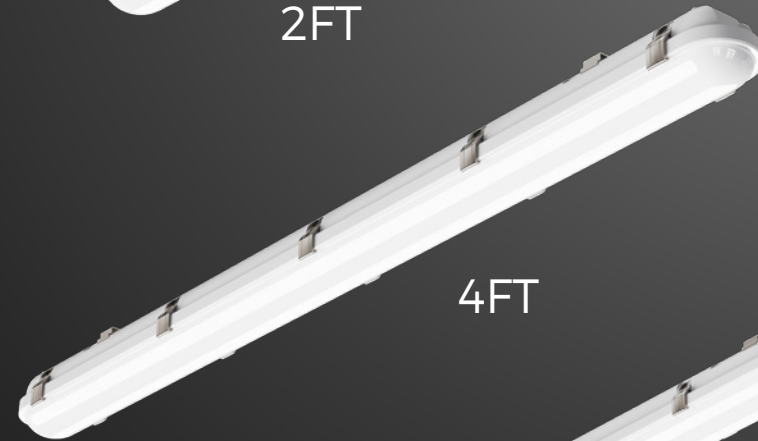

4FT

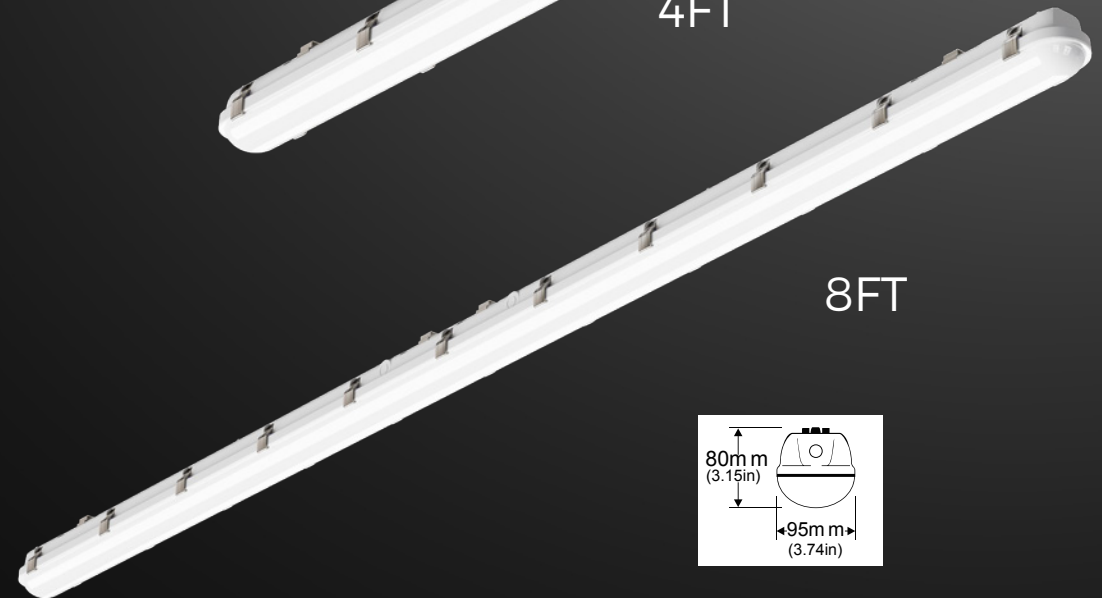

8FT

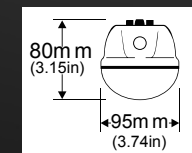

## Dimension

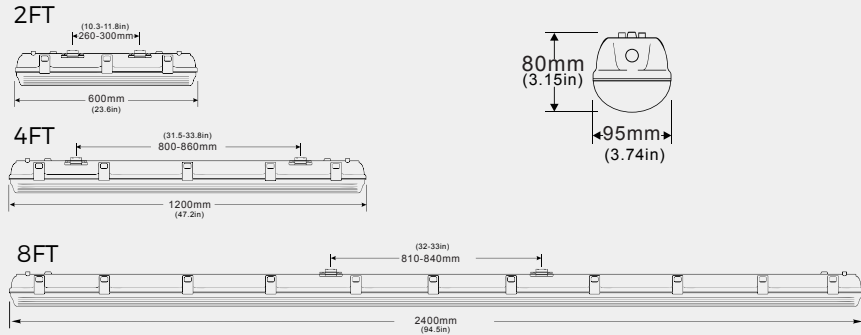

## Advanced Designed



### INTEGRATED DESIGN.

Advanced design of polycarbonate diffuser integrated with lighting tray provide significant protection on LEDs and saving on installation and maintenance.

## 3-Power & 3-CCT Switchable

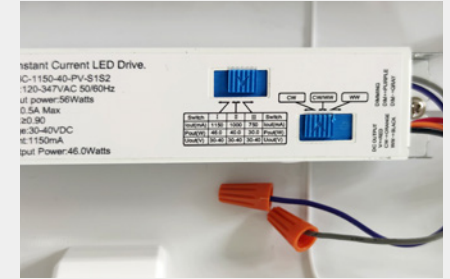

## Microwave Sensor optional



DIP Switchable Sensor

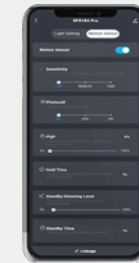

Bluetooth® Bluetooth Mesh Sensor

## Parameter

Model No.	Power	Dimension	Input	LEDs	Efficacy	Lumens	Ra	Angle	CCT	Control
VP-27A	25W/20W/15W Selectable	2FT	100-277V/347V	2835	130LM/W	2600LM	>80	120°	Single Color or 3-CCT Selectable	0-10V Sensor Bluetooth Emergency
VP4-40A	40W/32W/24W Selectable	4FT	100-277V/347V	2835	130LM/W	5200LM	>80			
VP4-54A	54W/50W/40W Selectable	4FT	100-277V/347V	2835	130LM/W	7000LM	>80			
VP4-80A	80W/70W/60W Selectable	8FT	100-277V/347V	2835	130LM/W	10400LM	>80			
VP4-100A	100W/88W/80W/72W Selectable	8FT	100-277V/347V	2835	130LM/W	13000LM	>80			

# VPA Plus

07/

## Vapor Tight Fixture

- 2FT 4FT 8FT available
- 3-Power & 3-CCT Switchbale
- IP66 Wet Location,
- Luminous Efficacy 150lm/w
- AC120-277V/AC120-347V optional
- 0-10V dimmable in standard
- Sensor and Emergency optional

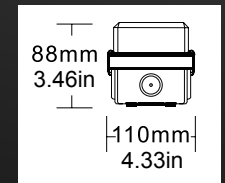
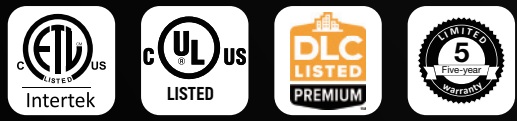
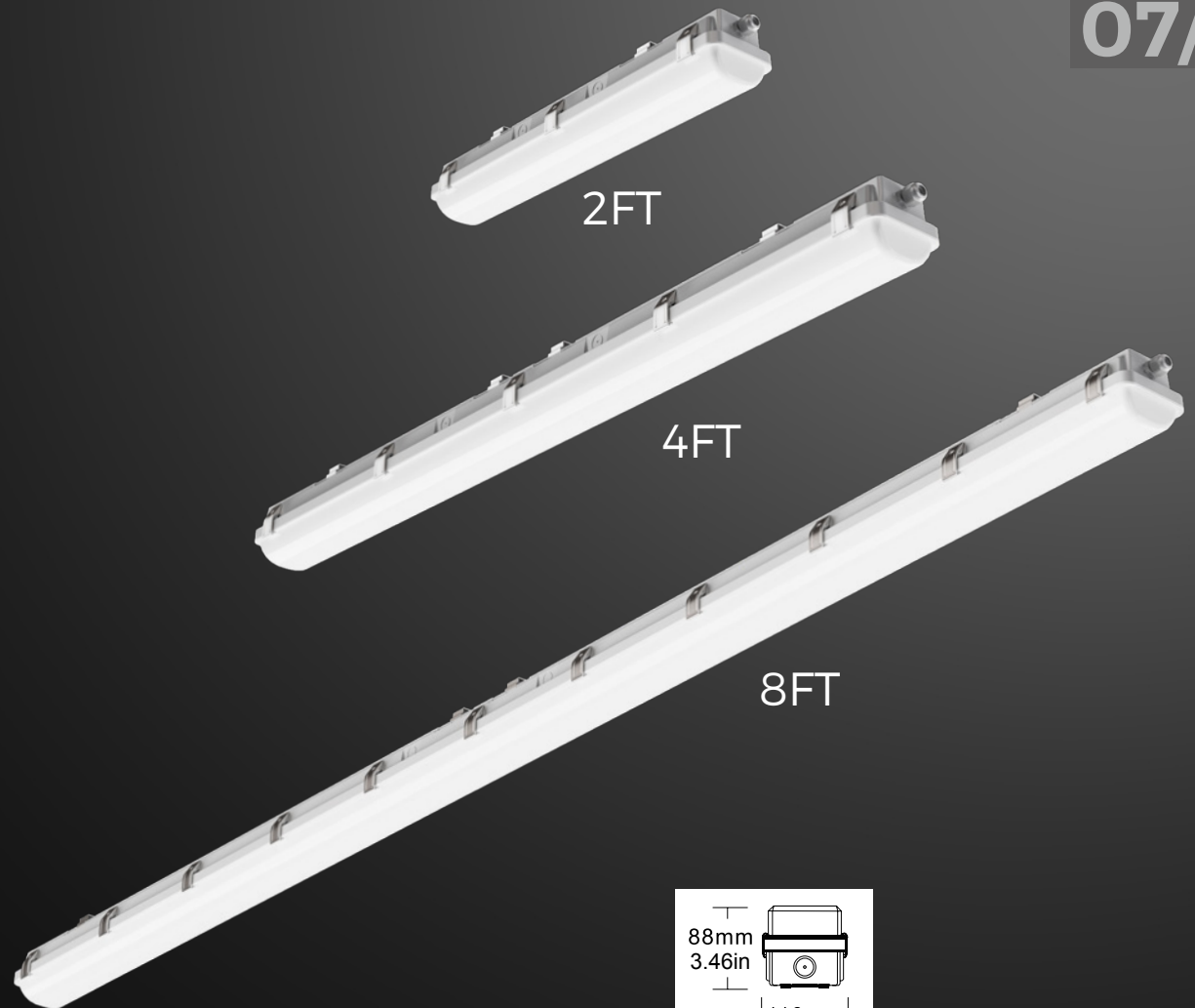

## Distribution

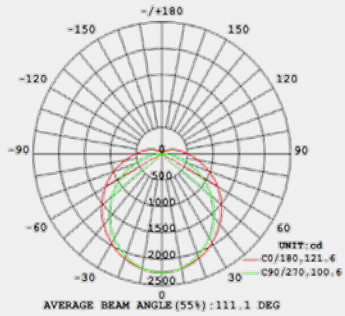

## Dimension

2FT



4FT

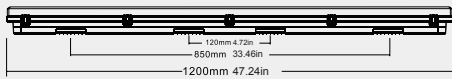

8FT

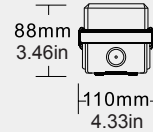
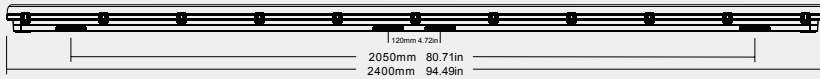

## Parameter

Model No.	Power	Dimension	Input	LEDs	Efficacy	Lumens	Ra	Angle	Efficacy	Control
VP2-20A	25W/20W/15W Selectable	2FT	100-277V/347V	2835	130LM/W	2600LM	>80	120°	Single color or 3-CCT Selectable	0-10V Sensor Bluetooth Emergency
VP4-40A	40W/32W/24W Selectable	4FT	100-277V/347V	2835	130LM/W	5200LM	>80			
VP-54-HV	54W/50W/40W Selectable	4FT	100-277V/347V	2835	130LM/W	7000LM	>80			
VP-80A	80W/70W/60W Selectable	8FT	100-277V/347V	2835	130LM/W	10400LM	>80			
VP-120A	120W/100W/80W Selectable	8FT	100-277V/347V	2835	130LM/W	15600LM	>80			

## Advantage

### All-polycarbonate Construction

V0 fire retardant polycarbonate ensure high standard of safety and maximum impact rate of IK08.

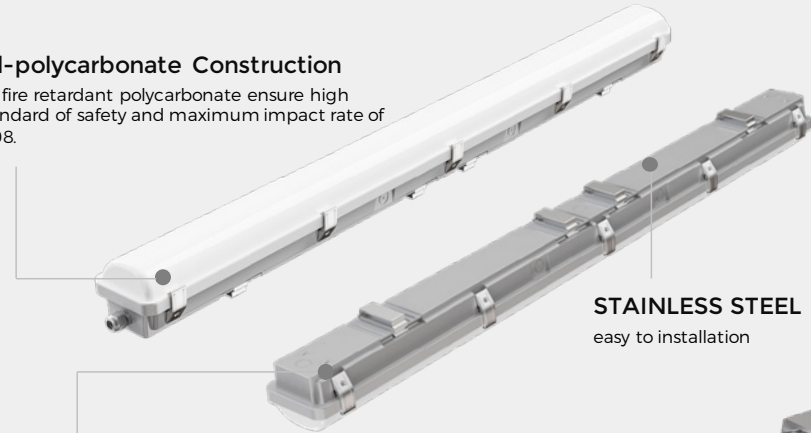

**STAINLESS STEEL**  
easy to installation

### IP66 PROTECTION

waterproof, dustproof and anticorrosive

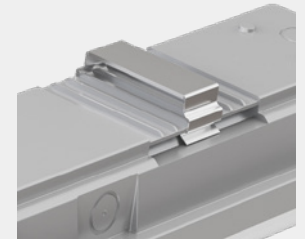

The mounting brackets keep adjustable space for easy correction.



### INTEGRATED DESIGN.

Advanced design of polycarbonate diffuse integrated with lighting tray provide significant protection on LEDs and saving on installtion and maintenance.

# VPE

08/

## Vapor Tight Fixture

- DLC 5.1 Premium Listed
- IP66 Wet Location
- Easy wiring and linkable
- 0-10V dimming optional
- 140lm/w and 150lm/w optional
- Bi-level Sensor, Emergency optional
- Multi-Voltage: 120-347Vac optional



## Distribution

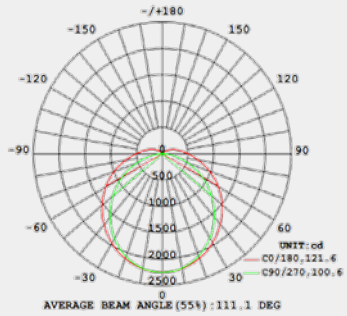

## Linkable connections



## Linkable connections

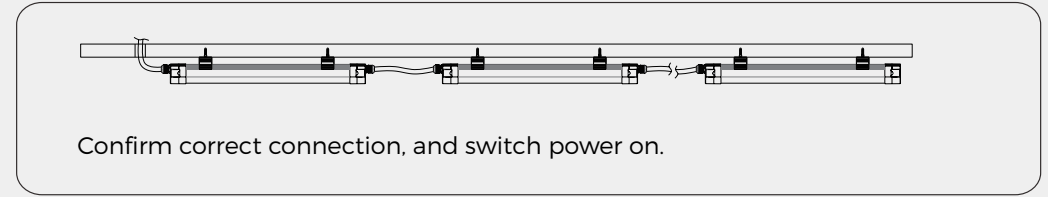
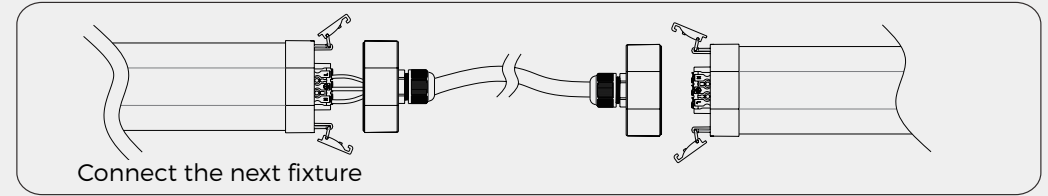

## Easy to Wiring

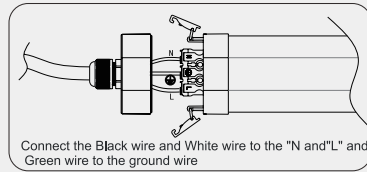
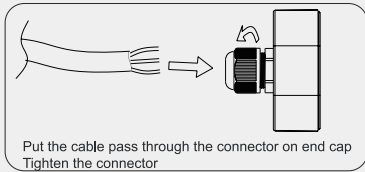
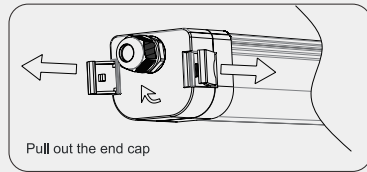
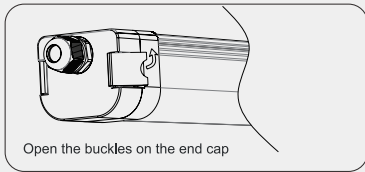

## Easy to add external sensor



## Parameter

Model No.	Power	Dimension	Input	LEDs	Efficacy	Lumens	Ra	Angle	Efficacy	Control
VPE230	30W	2FT	100-277/347V	2835	140LM/W	4200LM	>80			
VPE440L	40W	4FT	100-277/347V	2835	140LM/W	5600LM	>80			
VPE460	60W	4FT	100-277/347V	2835	140LM/W	8400LM	>80	120°	3000K 4000K 5000K 5700K	0-10V Sensor Bluetooth
VPE890	90W	8FT	100-277/347V	2835	140LM/W	12600LM	>80			
VPE8120	120W	8FT	100-277/347V	2835	140LM/W	16800LM	>80			

## Smart Function optional



Internal Sensor  
(assembled at Factory)



External Sensor  
(Support DIY)

DIP Switch Setting

Sensitivity		Hold-time			Daylight threshold			Stand-by period			Stand-by dimming level	
DIP switch	1	DIP switch	2	3	DIP switch	4	5	DIP switch	6	7	DIP switch	8
100%	<input checked="" type="checkbox"/>	Sc	<input checked="" type="checkbox"/>	<input checked="" type="checkbox"/>	10Lux	<input checked="" type="checkbox"/>	<input checked="" type="checkbox"/>	10s	<input checked="" type="checkbox"/>	<input checked="" type="checkbox"/>	20%	<input checked="" type="checkbox"/>
50%	<input type="checkbox"/>	90s	<input checked="" type="checkbox"/>	<input checked="" type="checkbox"/>	25Lux	<input checked="" type="checkbox"/>	<input checked="" type="checkbox"/>	15min	<input checked="" type="checkbox"/>	<input checked="" type="checkbox"/>	30%	<input type="checkbox"/>
		10min	<input type="checkbox"/>	<input type="checkbox"/>	10Lux	<input type="checkbox"/>	<input type="checkbox"/>	∞	<input type="checkbox"/>	<input type="checkbox"/>		<input type="checkbox"/>

Remote control APP/Wall Switch/Remote Control

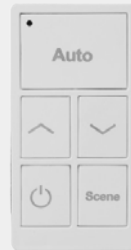

## Bluetooth SIG Mesh Sensor and dimming Control

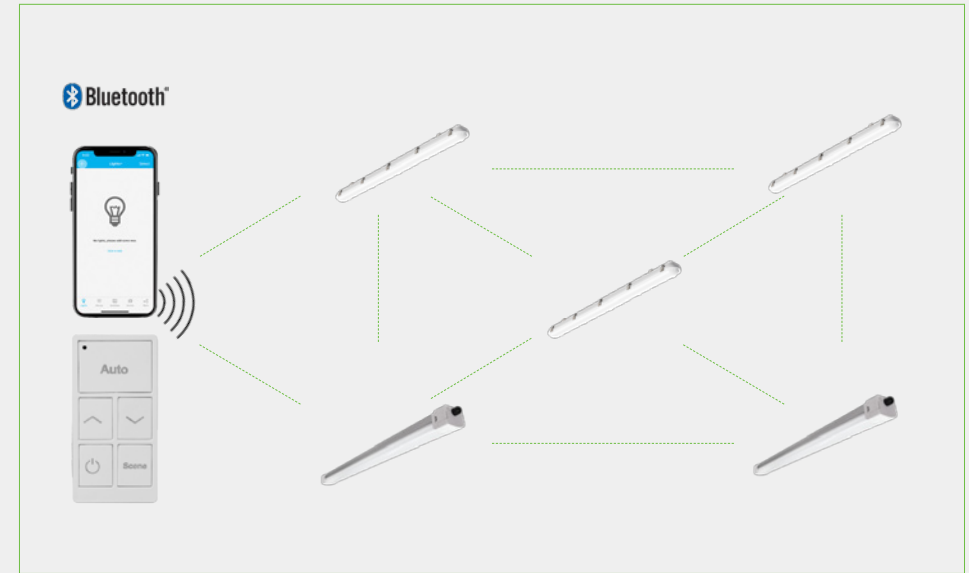

**Wireless Bluetooth SIG Mesh** between 30M/100FT  
Distance of two Fixtures.



**Group control**, Support 100pcs in one Group.



**Schedule and Timer**, like 9:00AM ON, 18:00 OFF.



**Scene Setting**, like meeting, working etc.



**Motion Sensor and Daylight harvest options**,  
automatically turn on, turn off and dim the lights.



**Linkage**, other lights in the same group detects movement, and the linkage is turned on in this group, then this light will dim to linkage light level.



**Wireless Control and no need Hub**



**APP System** is Easy to operated

# LED LINEAR STRIP LIGHT



09

LSC

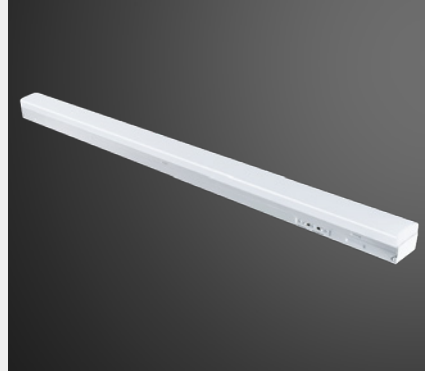

10

LSD



11

LSA





# LSC

09/

## Linear Strip Light

- DLC 5.1 Premium Listed
- High Lumens 130lm/w, CRI>80Ra
- 3-Power & 3-CCT switchable
- Multi-Voltage: 100-277V/347V, 0-10V Dim
- Daisy connection with very convenient replacement in 1 minute
- Emergency backup and sensor optional
- Easy installation, suspending & surface mounted



## Installation

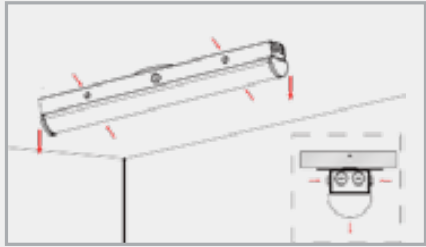

Surface-mounted

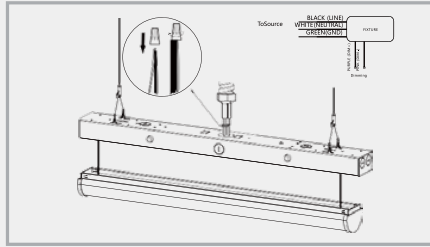

Suspending

## Dimension

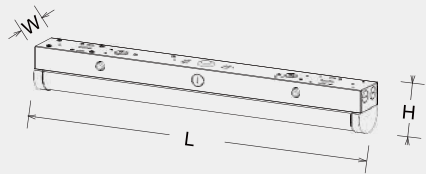

MODE	LxWxH
2FT	609x75x83(mm) / 23.97"x2.95"x3.26"
4FT	1220x75x83(mm) / 48.03"x2.95"x3.26"
8FT	2438x75x83(mm) / 95.98"x2.95"x3.26"

## Advantage

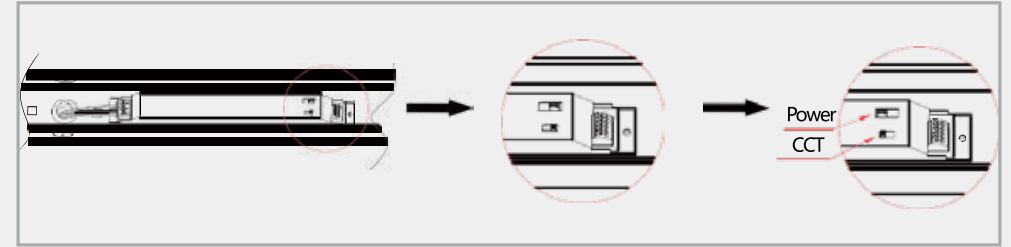

Linkable



0-10V Dimmable  
100-277/347V

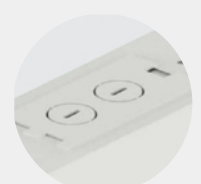

Removable plate  
for connecting easily



## Parameter

Model No.	Power	Dimension	Input	LEDs	Efficacy	Lumens	Ra	Beam Angle	CCT	Control
LSC-4FT40W	40W	4FT	100-277/347V	2835	130LM/W	5200LM	>80	120°	3000K 4000K 5000K	0-10 Dim Sensor Emergency Bluetooth
LSC-8FT80W	80W	8FT	100-277/347V	2835	130LM/W	10400LM	>80			
LSC-4FT40/32/24W	40W/32W/24W	4FT	100-277/347V	2835	130LM/W	5200LM	>80			
LSC-8FT64/50/40W	64W/50W/40W	8FT	100-277/347V	2835	130LM/W	8320LM	>80		3-CCT Switchable	
LSC-8FT80/70/60W	80W/70W/60W	8FT	100-277/347V	2835	130LM/W	10400LM	>80			

# LSD

## Linear Strip Light

- DLC 5.1 Premium Listed
- High Lumens 140-150lm/w, CRI>80Ra
- 3-Power & 3-CCT switchable
- Multi-Voltage: 100-277V/347V, 0-10V Dim
- Daisy connection with very convenient replacement in 1 minute
- Emergency backup and sensor optional
- Easy installation, suspending mounting & surface mounted

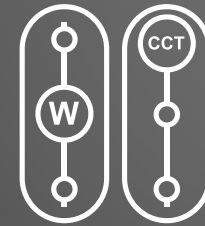

10/

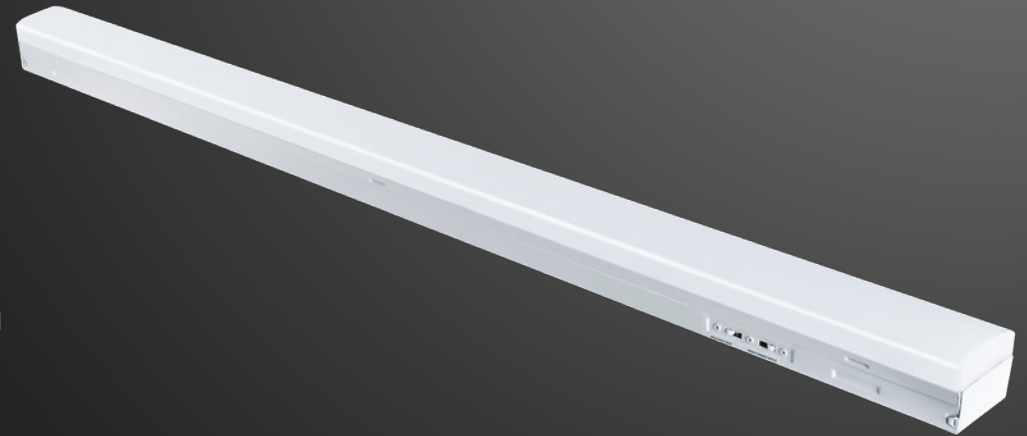

## Motion Sensor Available



## Hanging with V hook and rope



## CCT and Wattages selectability with on-site switch

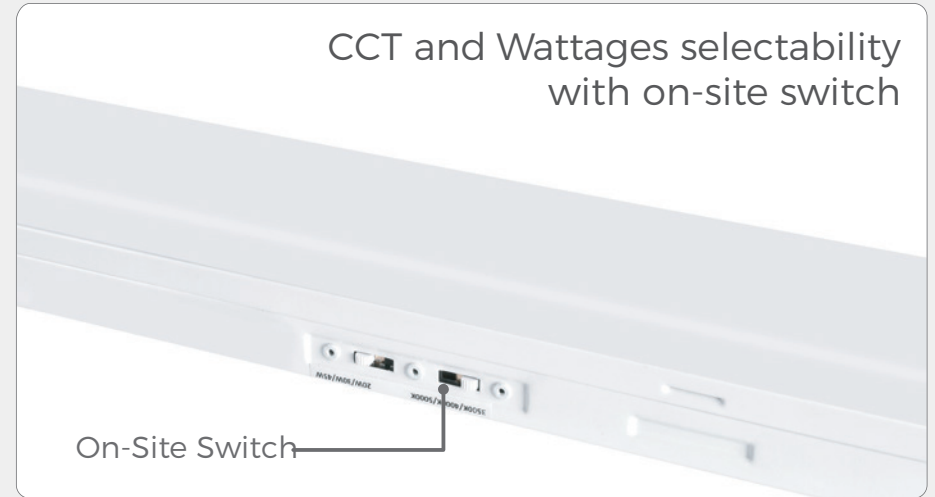

## Dimension

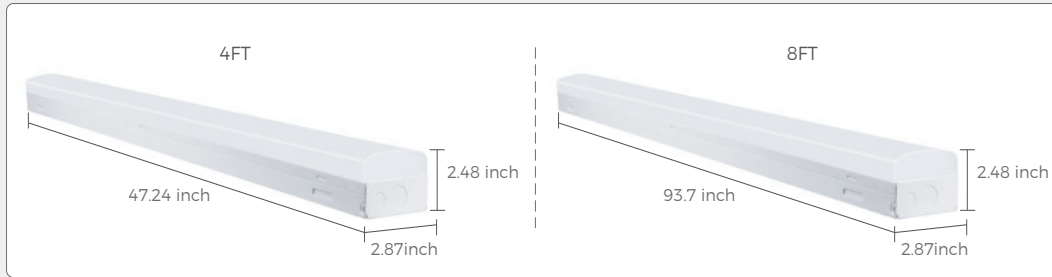

## Parameter

Model No.	Power	Dimension	Input	LEDs	Efficacy	Lumens	Ra	Beam Angle	CCT	Control
LSD-4FT-TCP	45W-18W Selectable	4FT	100-277V/347V	2835	145lm/w	6500lm	>80	120°	3-CCT Switchable 3000K 4000K 5000K	0-10V Sensor Emergency Bluetooth
LSD-8FT-TCP	90W-60W Selectable	8FT	100-277V/347V	2835	145lm/w	13000lm	>80			

# LSA

11/

**High Power**  
4FT = 60W  
8FT = 120W



## Outside Quick Linkable Linear Strip Light

- DLC 5.1 Premium Listed
- High Lumens 140lm/w  
(200lm/w optional)
- Multi-Voltage: 100-277V/347V, 0-10V Dim
- Outside quick linkable
- Emergency backup and sensor optional
- Easy installation, suspending  
& surface mounted

### Outside quick linkable



## Installation



## Advantage



CCT and Wattages selectability with on-site switch

Seamless Connection

## Dimension

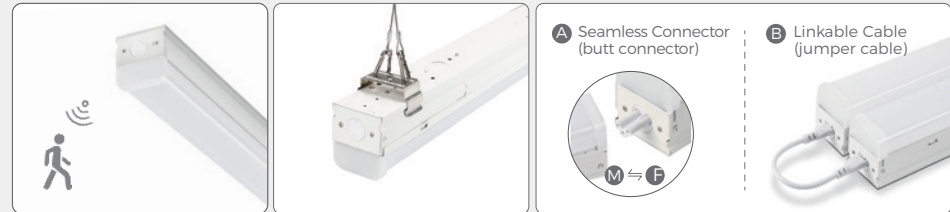

## Parameter

Model No.	Power	Dimension	Input	LEDs	Efficacy	Lumens	Ra	Beam Angle	CCT	Control
LSA-4FT38W	38W	4FT	100-277/347V	2835	140LM/W	5320LM	>80			
LSA-4FT60W	60W	4FT	100-277/347V	2835	140LM/W	8400LM	>80			
LSA-8FT60W	60W	8FT	100-277/347V	2835	140LM/W	8400LM	>80	120°	Single color or 3-CCT Switchable	0-10V Dim Sensor Emergency Bluetooth
LSA-8FT80W	80W	8FT	100-277/347V	2835	140LM/W	11200LM	>80			
LSA-8FT120W	120W	8FT	100-277/347V	2835	140LM/W	16800LM	>80			

## Smart Function optional



Built-in Sensor

External Sensor



Sensor  
(PIR or Microwave)



Bluetooth Mesh Sensor  
(PIR or Microwave)

Remote control



Bluetooth  
APP/Wall Switch/Remote Control



## Bluetooth SIG Mesh Sensor and dimming Control

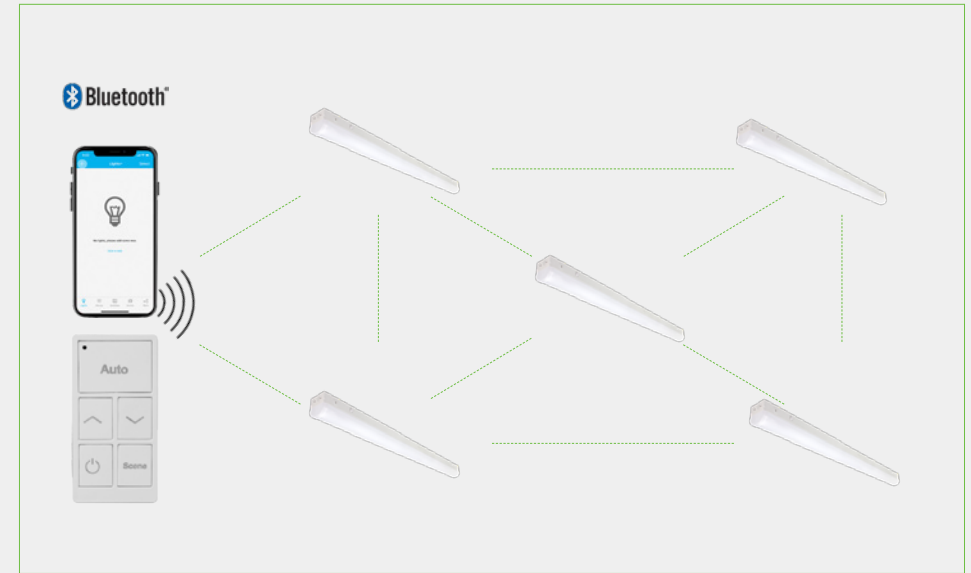

**Wireless Bluetooth SIG Mesh** between 30M/100FT  
Distance of two Fixtures.



**Group control.** Support 100pcs in one Group.



**Schedule and Timer,** like 9:00AM ON, 18:00 OFF.



**Scene Setting,** like meeting, working etc.



**Motion Sensor and Daylight harvest options,**  
automatically turn on, turn off and dim the lights.



**Linkage,** other lights in the same group detects movement, and the linkage is turned on in this group, then this light will dim to linkage light level.



**Wireless Control and no need Hub**



**APP System** is Easy to operated

# ARCHITECTURE LINEAR LIGHT

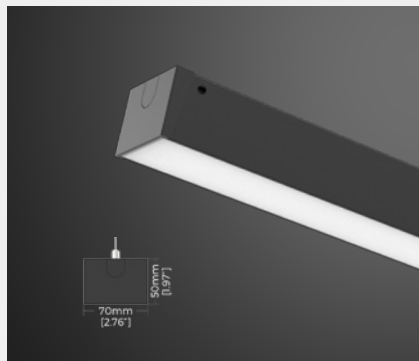

12

Nexus

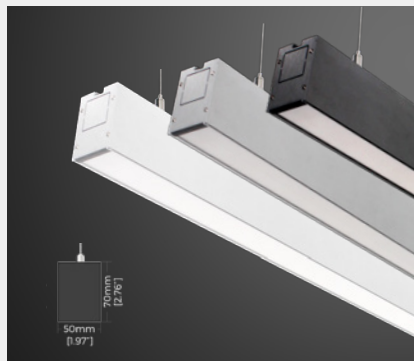

13

Lambert

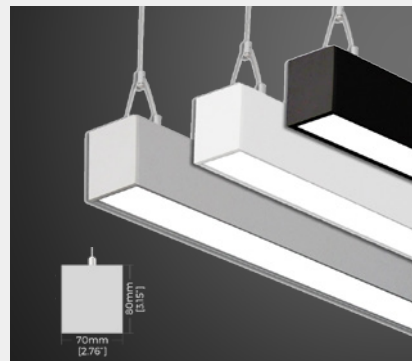

14

Flexible



15

Slender





# Nexus

12/

## Architecture Linear Light

- High Luminous Efficiency  
130-150lm/w
- CRI>80Ra, SDCM: <5
- UGR<22 or UGR<16
- 3-Power & 3-CCT Switchable
- Flicker Free driver, PF>0.9
- Ceiling and Suspending installation
- 0-10V Dimmable
- 5 Years Warranty

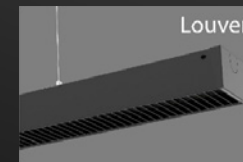
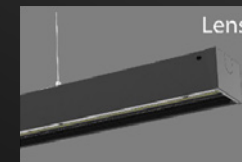
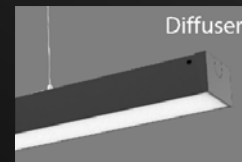
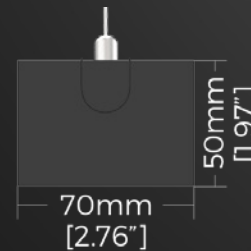
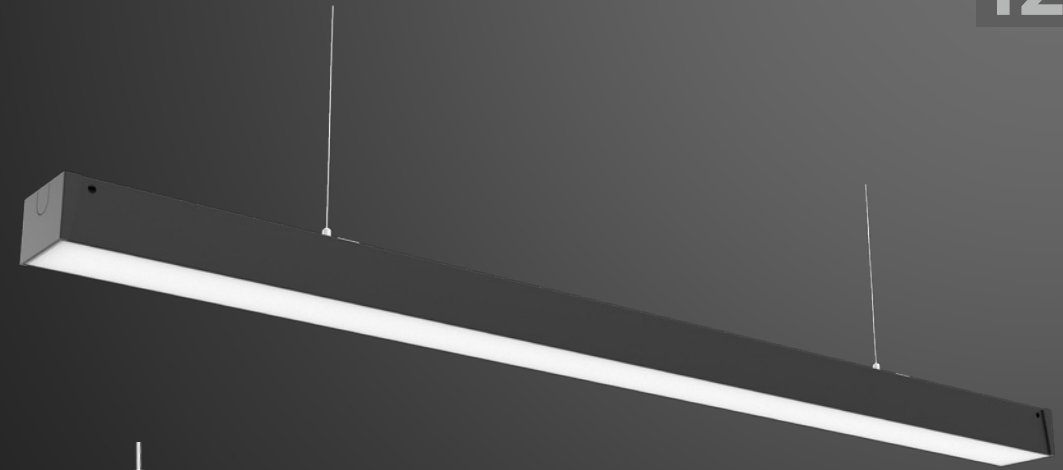

## Distribution

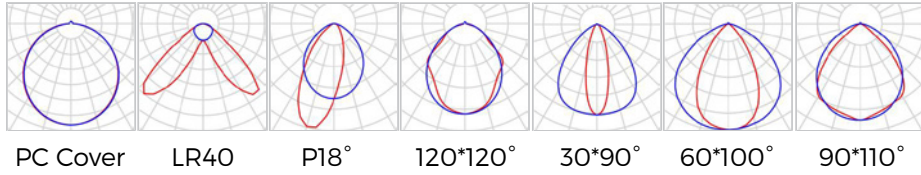

## Easy wiring

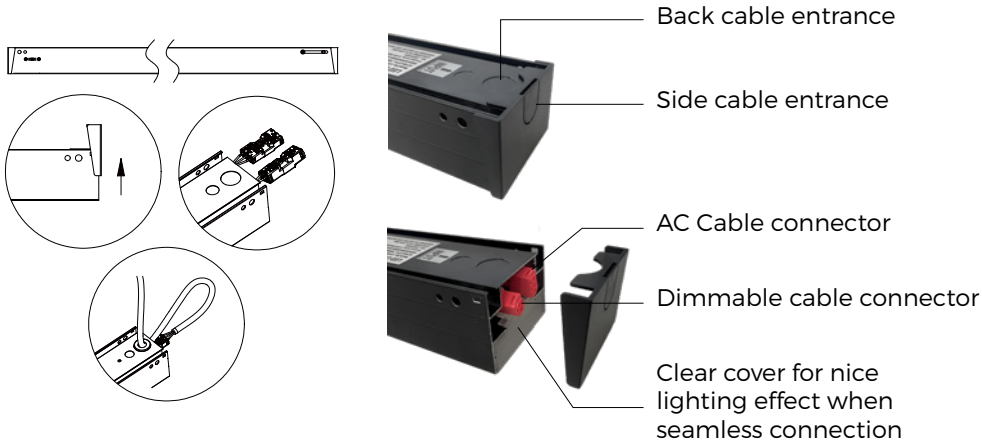

One model inventory: wires for series connection preset inside, support single installation as well as in-series installation.

## Parameter

Model No.	Power	Dimension	Input	LEDs	Efficacy	Lumens	Ra	UGR	CCT	Control
L7050-20W	20W	2FT	200-240V	2835	130LM/W	2600LM	>80			
L7050-40W	40W	4FT	200-240V	2835	130LM/W	5200LM	>80	<22 <19	Single color or 3-CCT Switchable	0-10V 2.4G Remote Smart
L7050-60W	60W	5FT	200-240V	2835	130LM/W	7800LM	>80			

## Seamless Connection

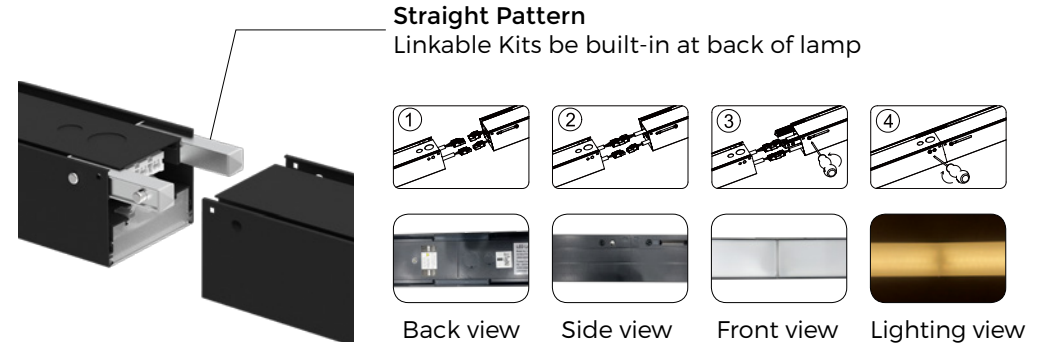

## Vary Pattern

Rotatable Linkable kits

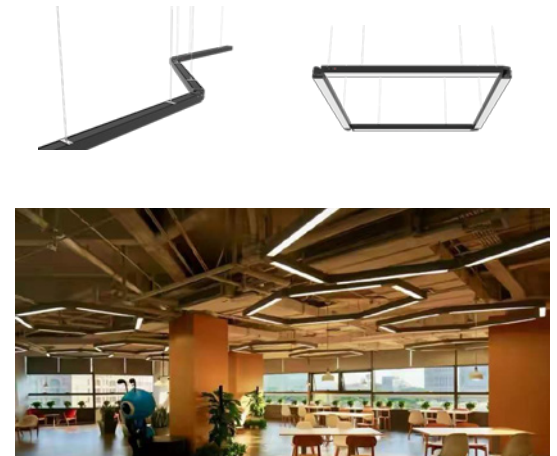
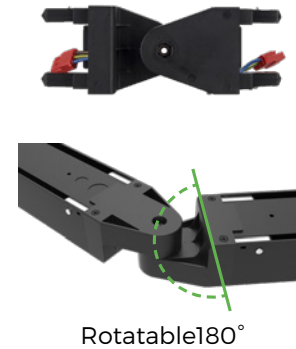

# Lambert

13/

## Architecture Linear Light

- Independently modular Direct & Indirect luminaires
- 3-Power & 3-CCT Switchable
- Unique end cap simplifies installation , seamless continuous runs or individuals
- Specially designed light source with PC diffuser producing soft light
- 0-10 dimming ,ELV, Dali , Triac, 2.4G wireless control,Bluetooth Mesh control
- Suspended, Ceiling mount, Wall mount, Recessed installation available

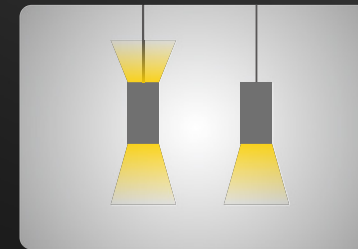

## Advantage

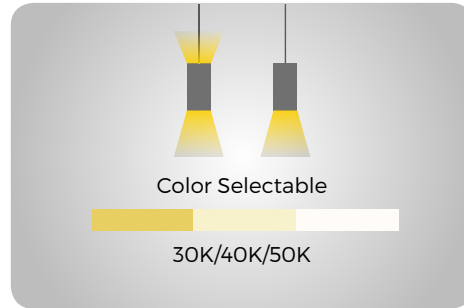
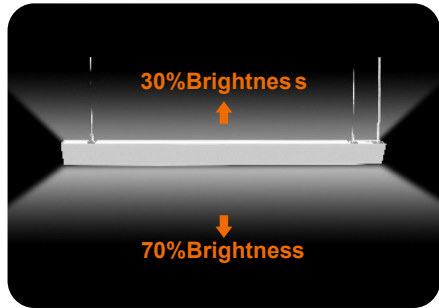

## Dimension

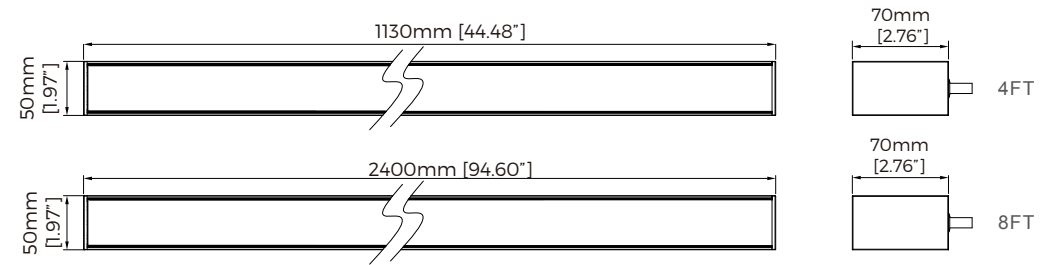

## Mounting Options

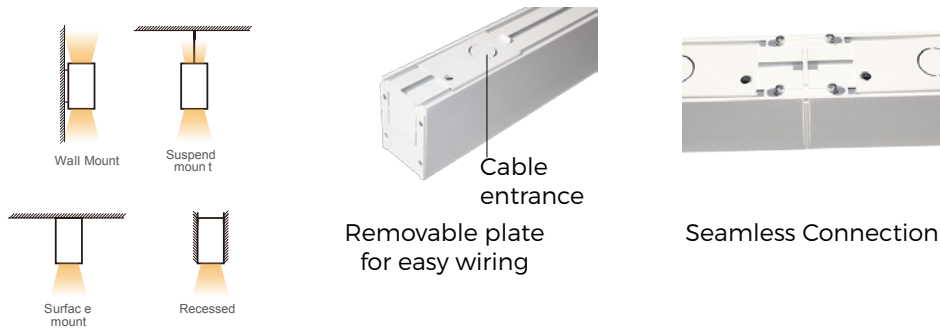

## Application

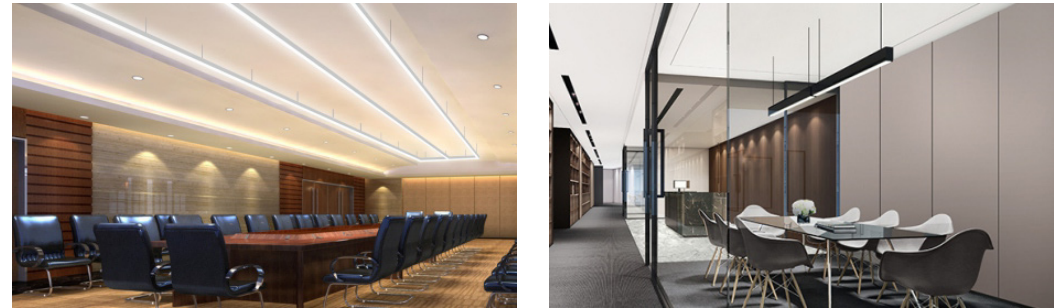

## Parameter

Type	Model No.	Power	Dimension	Input	LEDs	Efficacy	Lumens	Ra	UGR	CCT	Control
	MSD4FT36ADHV-3CK	36W	4FT	200-240V	2835	110LM/W	3900LM	>80/90	<22	Single color or 3-CCT Switchable	0-10V DALI 2.4G Remote Smart
	MSD8FT72ADHV-3CK	72W	8FT	200-240V	2835	110LM/W	7800LM	>80/90			
	MSUD4FT50ADHV-3CK	35W+15W	4FT	200-240V	2835	110LM/W	5500LM	>80/90			
	MSUD8FT100ADHV-3CK	70W+30W	8FT	200-240V	2835	110LM/W	11000LM	>80/90			

# Flexible

14/

## Architecture Linear Light

- Independently modular Direct & Indirect luminaries
- Separated 3-CCT Switchable for up and down light by two external Dip switches
- Watt convertible ,support 0-10V dimming (Up 30%+ Down 70%,Up 50%+Down 50%, Up70%+Down30%)
- Unique end cap simplifies installation ,seamless continuous runs or individuals
- Specially designed light source with PC diffuser producing soft light
- 0-10 dimming ,ELV, Dali , Triac, Bluetooth Mesh,2.4G wireless control, emergency backup available.
- Suspended, Ceiling mount, Wall mount, Recessed installation available



## C Series

Upper CCT Collect Toggle (30-40-50K)      Down CCT Collect Toggle (30-40-50K)

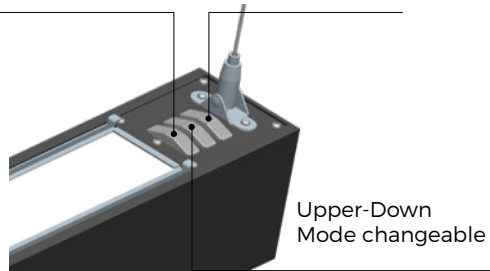

Upper-Down Mode changeable

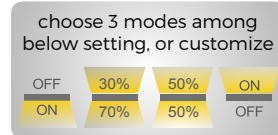
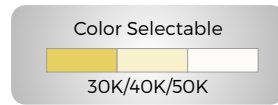

## E Series

Upper and Down Power Selectable

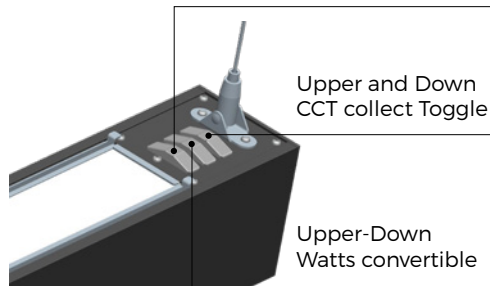

Upper and Down CCT collect Toggle

Upper-Down Watts convertible

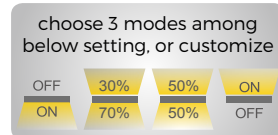
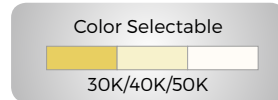
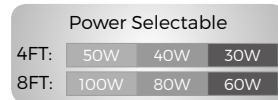

## Installation options

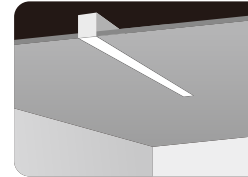

Recessed Mount



Wall Mount



Surface Mount



Suspending

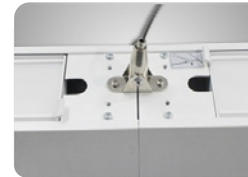

Seamless Connection



Linkable Bracket



Suspending

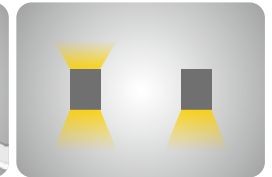

Direct & Indirect Light

## Application

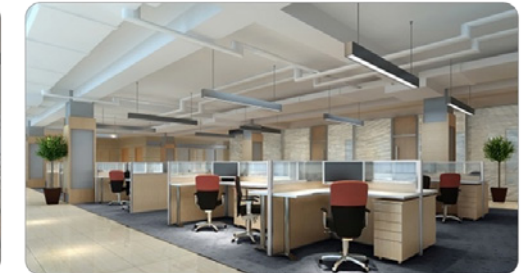

## Parameter

Model No.	Power	Dimension	Input	LEDs	Efficacy	Lumens	Ra	UGR	CCT	Control
2LSUD4FT50WCDHV	50W	4FT	200-240V	2835	110LM/W	5500LM	>80/90	<22	Single color or 3-CCT Switchable	0-10V DALI 2.4G Remote Smart
2LSUD6FT80WADHV	80W	6FT	200-240V	2835	110LM/W	8800LM	>80/90			
2LSUD8FT100WADHV	100W	8FT	200-240V	2835	110LM/W	11000LM	>80/90			

# Slender

## Architecture Linear Light

- Ultra-thin Design, only 16mm in Height
- Narrow fixture with a beam angle of 120°
- Direct and indirect options
- Specially designed light source with PC diffuser producing soft light
- Finish Color :Matte Black/Matte White/Matte Satin Aluminum or customize finishing
- 0-10 dimming ,ELV, Dali , Triac, 2.4G wireless control smart control
- Suspending installation

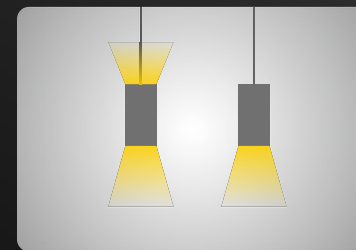

## Advantage



## Three colors

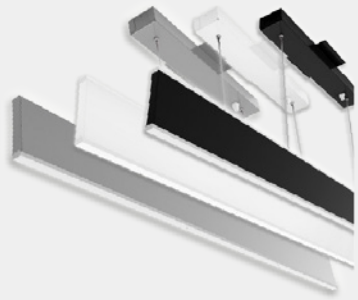

## Dimension

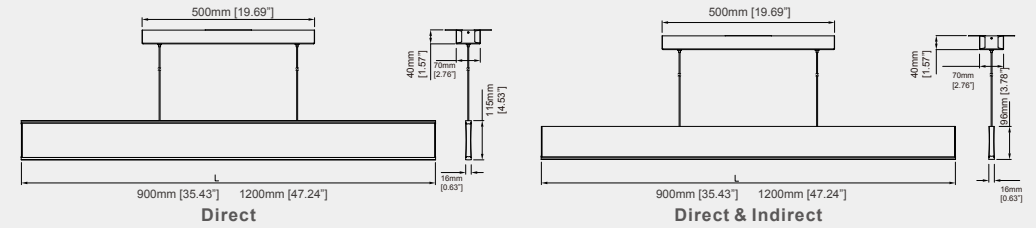

## Application

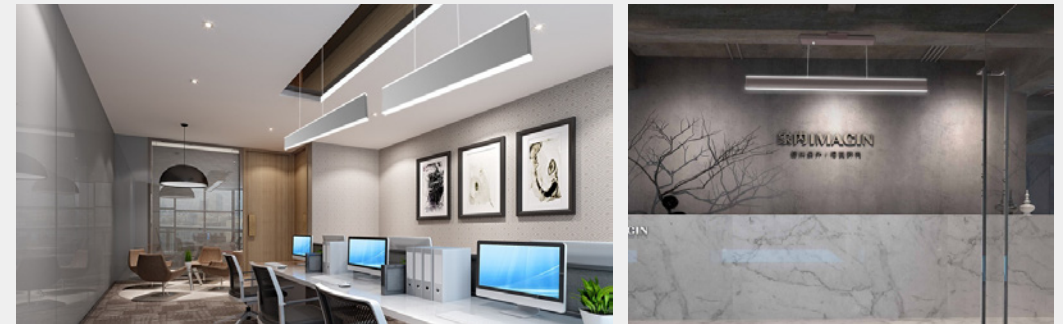

## Parameter

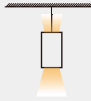
Type	Model No.	Power	Dimension	Input	LEDs	Efficacy	Lumens	Ra	CCT	Control
	SSD3FT18WADHV-xxK	18W	3FT	200-240V	2835	115LM/W	2070LM	>80/90	3000K 4000K 5000K	No-Dim 0-10V DALI 2.4G Remote Smart
	SSD4FT25WADHV-xxK	25W	4FT	200-240V	2835	115LM/W	2875LM	>80/90		
	SSUD3FT18WADHV-xxK	18W+7W	3FT	200-240V	2835	115LM/W	2875LM	>80/90		
	SSUD4FT25WADHV-xxK	25W+11W	4FT	200-240V	2835	115LM/W	4200LM	>80/90		



# LED PANEL LIGHT



16

BPL

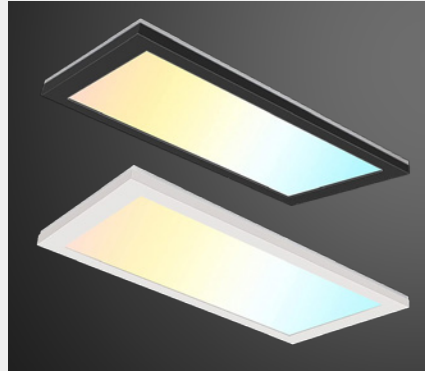

17

IPN



18

Oval 32"



# BPL

16/

## LED Panel Light

- DLC 5.1 Premium Listed
- 3-Power & 3-CCT Switchable
- Lower cost, higher cost effective
- High Strength Aluminum Alloy Frame
- 0-10V dimmable isolated Driver
- CRI>80 SDCM<5, L80>100,000H
- Luminous Efficiency up to 130lm/w



## Dimension

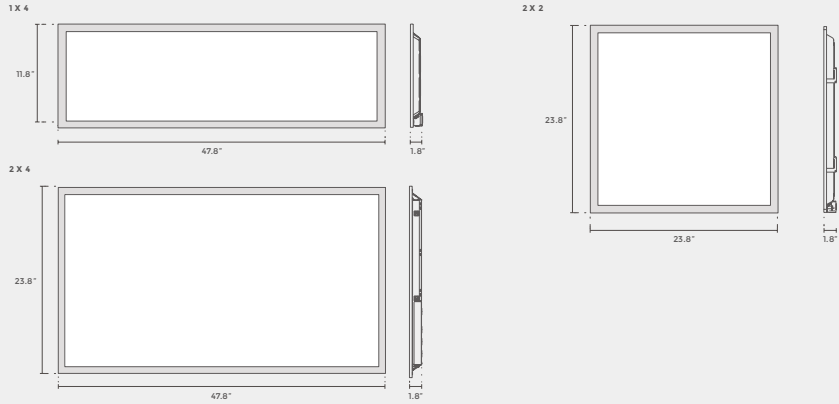

## Dip Switch



**3-Power and 3-CCT Selectable**

## Mounting Type

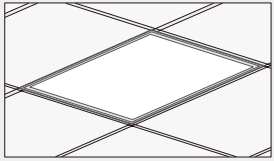

Recessed Mount

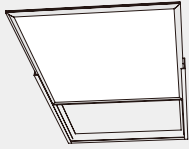

Surface Mount

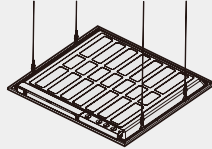

Suspended Mount



**Smooth Operation**  
No Flicker, Buzz, Or Bulbs

**No Hotspots**  
Wide View Optics

**Non Yellowing Diffuser**  
No Light Guide Panel

**Lightweight Design**  
Aluminum Frame

## Parameter

Model No.	Power	Dimension	Input	LEDs	Efficacy	Lumens	Ra	CCT	Control
BT.EDC-2X2-NND-P1-YY-TYDZ-RS	40W/30W/25W Selectable	2x2	100-277/347V	2835	130LM/W	5200LM	>80	3000K 4000K 5000K DIP Switch	0-10V Dim Sensor Bluetooth Emergency
BT.EDC-1X4-NND-P1-YY-TYDZ-RS	40W/30W/25W Selectable	1x4	100-277/347V	2835	130LM/W	5200LM	>80		
BT.EDC-2X4-NND-P1-YY-TYDZ-RS	50W/40W/30W Selectable	2x4	100-277/347V	2835	130LM/W	6500LM	>80		

## Smart Function optional



APP Control

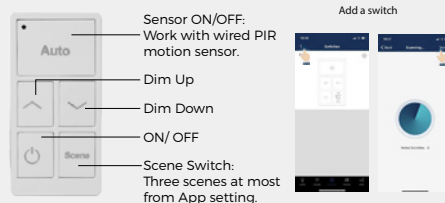

Wall Switch

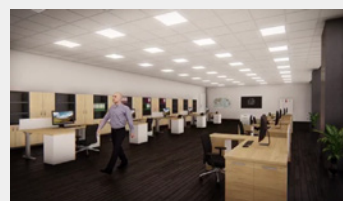
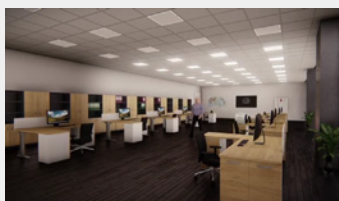
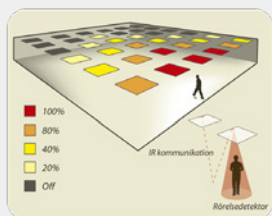

## Bluetooth SIG Mesh Sensor and dimming Control

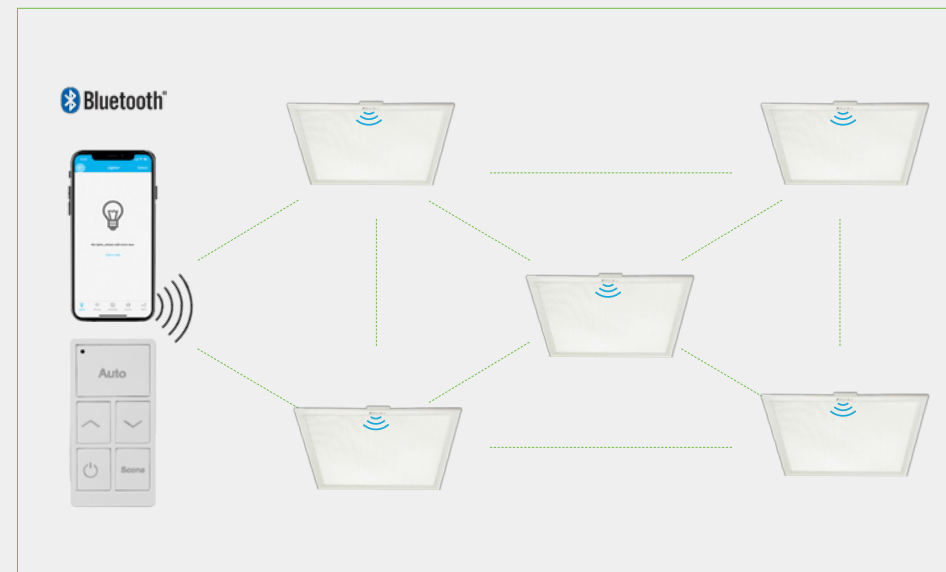

**Wireless Bluetooth SIG Mesh** between 30M/100FT Distance of two Fixtures.



**Group control.** Support 100pcs in one Group.



**Schedule and Timer,** like 9:00AM ON, 18:00 OFF.



**Scene Setting,** like meeting, working etc.



**Motion Sensor and Daylight harvest options,** automatically turn on, turn off and dim the lights.



**Linkage,** other lights in the same group detects movement, and the linkage is turned on in this group, then this light will dim to linkage light level.



**Wireless Control and no need Hub**



**APP System** is Easy to operated

# IPN Nightlight 1x2 1x4

## Surface Mount Panel Light

- 3-CCT Switchable
- With Nightlight Model optional
- High luminous efficacy 110lm/w
- 120Vac Triac Dimming
- PMMA Guide Lighting Plate Technology
- Ultra-thin 1.1 inch
- ETL listed
- 5 Years Warranty

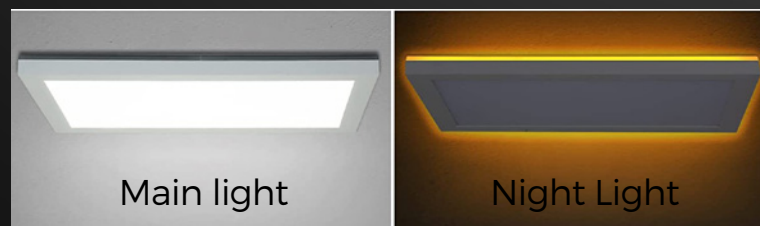
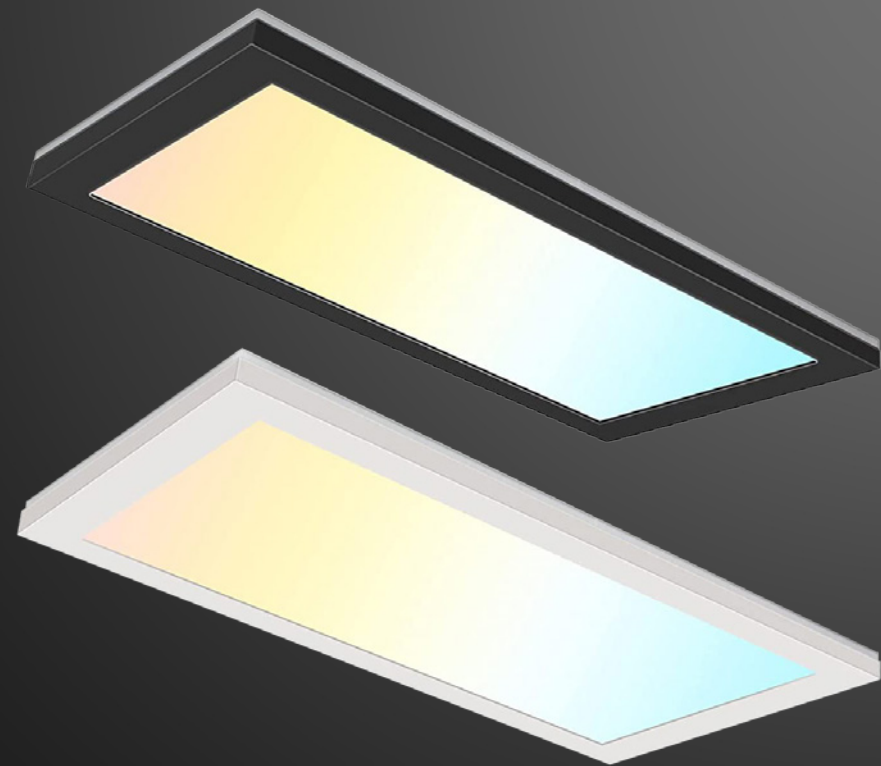

## Downlight & Nightlight Model

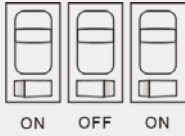
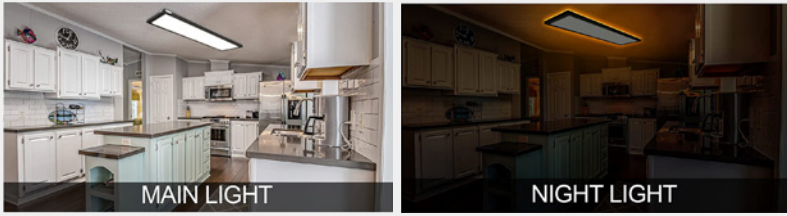

Flip wall switch **ON/OFF/ON**  
under 3 seconds to Chang Light Mode

## 3-CCT Switchable



## Dimension

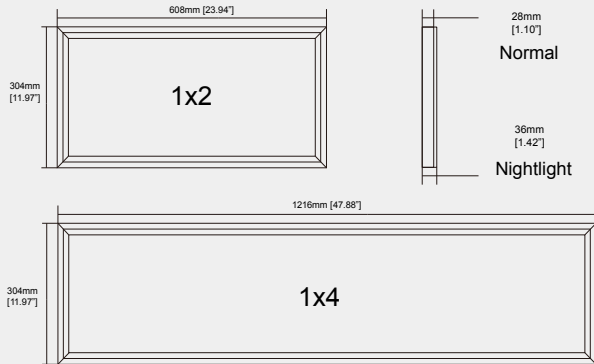

## Reliable Construction



**Edge-Lit Technology**  
Ultra-Thin 36mm [1 3/8"]

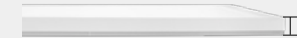

**High Quality driver**  
Long lifespan



## Parameter

Type	Model No.	Power	Size	Input	Efficacy	Lumens	Ra	Main Light	Night Light	Control
Without Nightlight	IPN-1020-3CT	24W	1x2	120V	100LM/W	2400LM	>80	3-CCT Switchable	/	Triac Dim
	IPN-1040-3CT	48W	1x4	120V	100LM/W	4800LM	>80			
With Nightlight	IPN-1020-6CT	24W+4W	1x2	120V	100LM/W	2400LM	>80	3-CCT Switchable	2000K Night Light	
	IPN-1040-6CT	42W+5W	1x4	120V	100LM/W	4200LM	>80			

# Oval 32" Nightlight

## Surface Mount Panel Light

- 3-CCT Switchable
- With Nightlight Model optional
- High luminous efficacy 110lm/w
- 120Vac Triac Dimming
- PMMA Guide Lighting Plate Technology
- Ultra-thin 1.1 inch
- ETL listed
- 5 Years Warranty

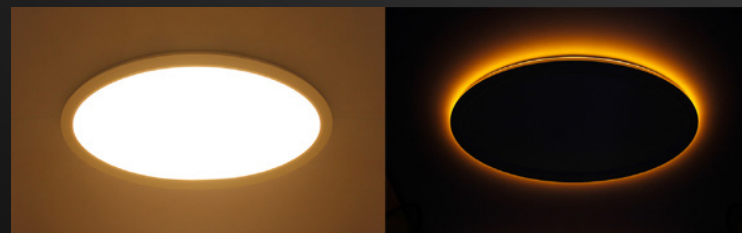

Main light

Night Light

## Downlight & Nightlight Model

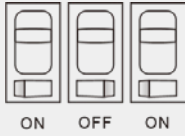
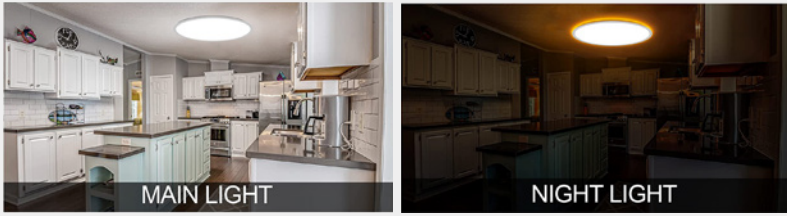

Flip wall switch **ON/OFF/ON**  
under 3 seconds to Chang Light Mode

## 3-CCT Switchable

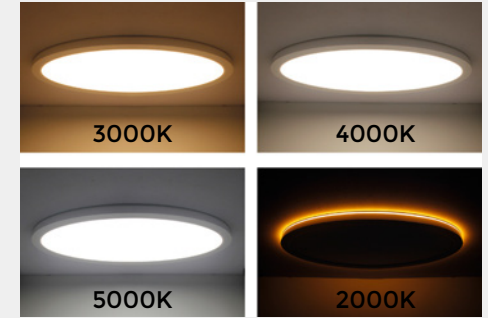

## Dimension

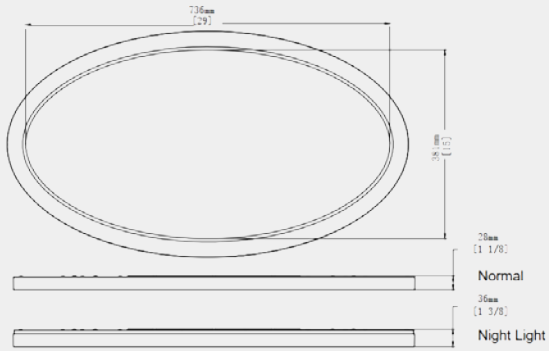

## Reliable Construction



**Edge-Lit Technology**  
Ultra-Thin 36mm [1 3/8"]



**High Quality driver**  
Long lifespan



## Parameter

Type	Model No.	Power	Size	Input	Efficacy	Lumens	Ra	Main Light	Night Light	Control
Without Nightlight	RCLR32-3CT	38W	32"	120V	100LM/W	3800LM	>80	3-CCT Switchable	/	Triac Dim
With Nightlight	RCLR32-6CTT	38W+4W	32"	120V	100LM/W	3800LM	>80	3-CCT Switchable	2000K Night Light	



# FLUSH MOUNT CEILING LIGHT



19

CP



20

FMB



21

FMC

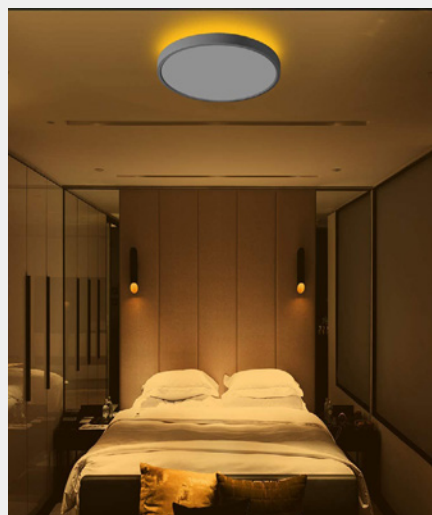

# CP

19/

## Flush Mount Ceiling Light

- Simple Look & Good Look
- Quick and Easy Installation.
- PC material, Fire Rating: V0
- 5-CCT Switchable
- Smart Control
- Voice Control

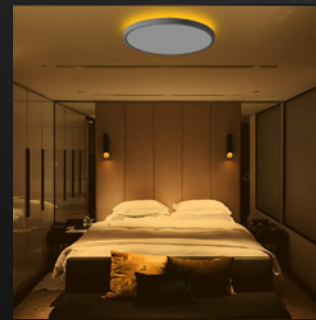

## Simple Look & Good Look



**IP5X**



**V0 Fire Rating**

0.94inch /24mm

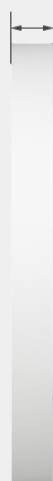

## Rotable Plate for easy installation

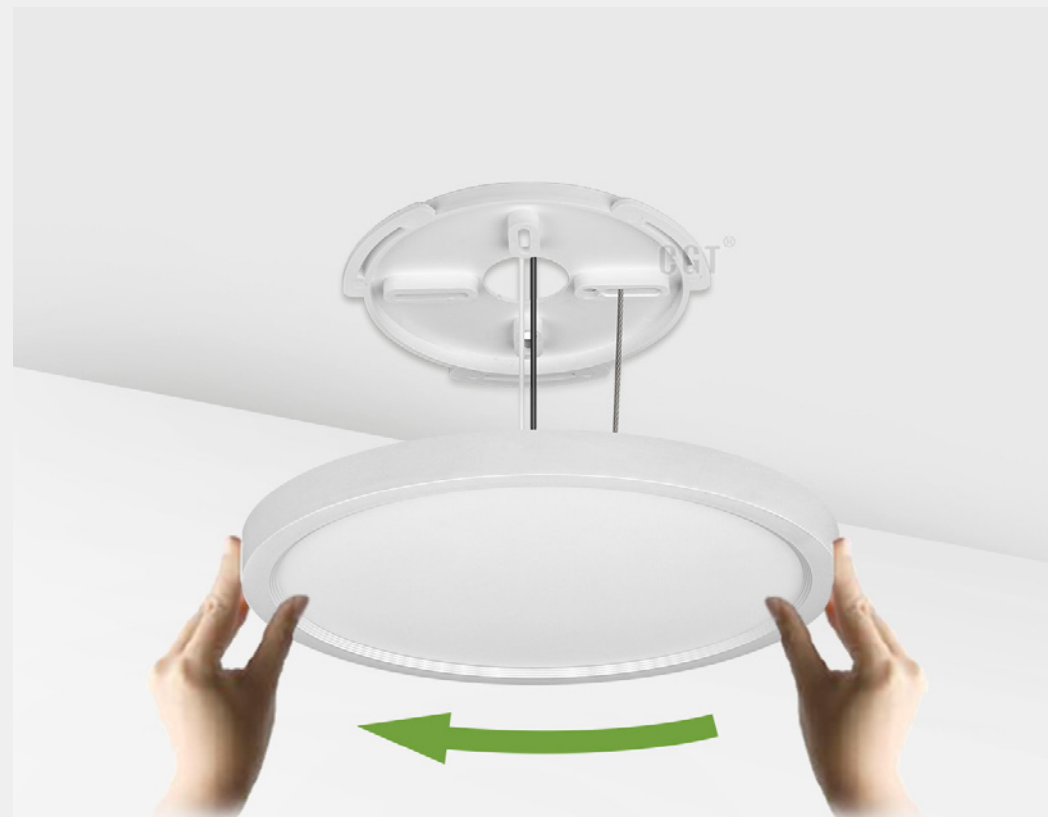

Compatible with the most junction boxes  
One For All, All For one



## A: 5-CCT Switchable

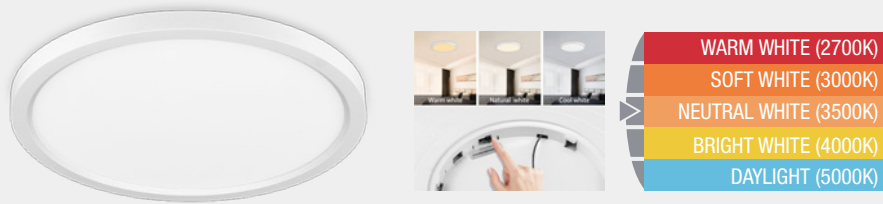

## B. 5-CCT with Night/Mood Light



## W1: WIFI Smart 2700-6500K Adjustable



## W2: WIFI Smart with RGB Night/Mood Light



## Parameter

Model No.	Power	Dimension	Input	Efficacy	Lumens	Ra	Main Light	Night Light	Control
FMA7	15W+2W	7.5"	120Vac	100LM/W	1800LM	>80	5-CCT Switchable 2700K-6500K Tunable	2000K RGB	Triac Dim Remoter Bluetooth WIFI
CP12	24W+2W	12"	120Vac	100LM/W	2400LM	>80			
CP16	32W+4W	16"	120Vac	100LM/W	3200LM	>80			

# FMB

20/

## Flush Mount Ceiling Light

- Traditional type
- 3-CCT Switchable
- Smart Control
- Voice Control

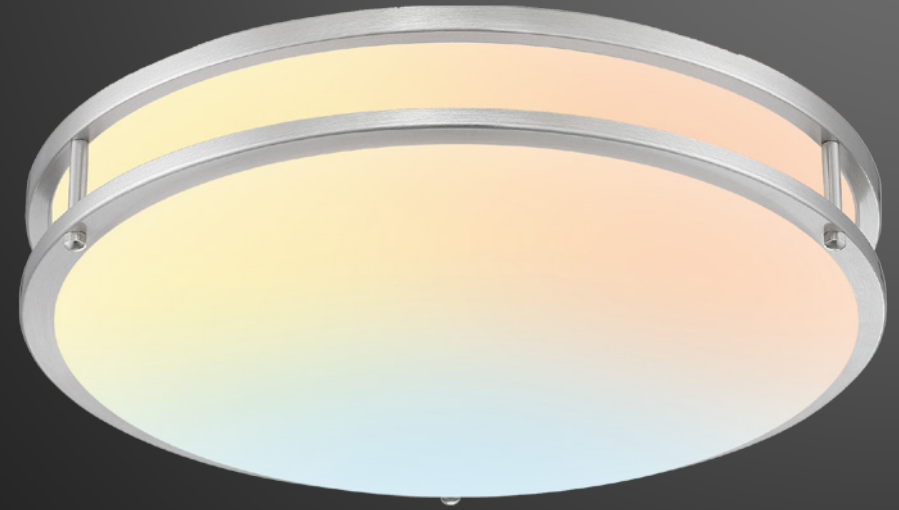

## A : 3-CCT Switchable +Change Mode optional

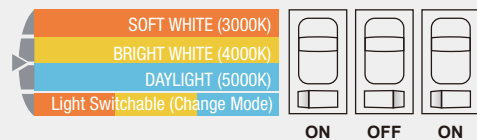

## W2: WIFI Smart with RGBCW adjustable

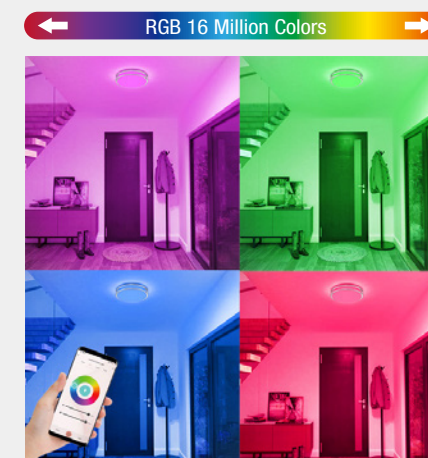
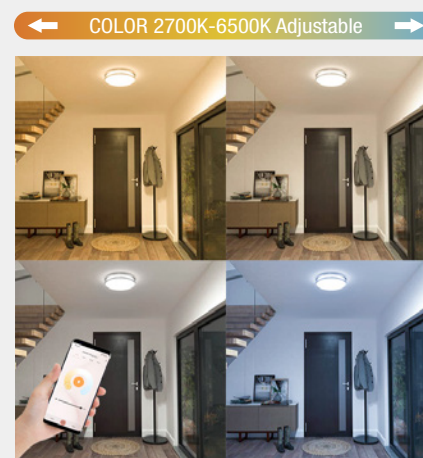
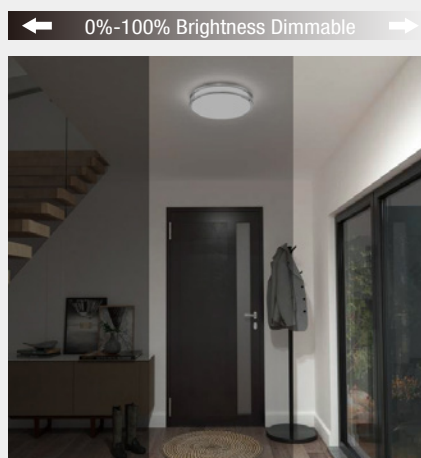
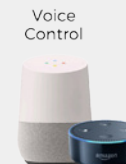
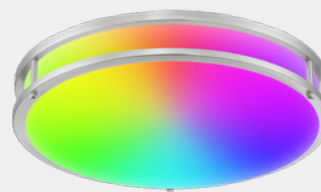

## Parameter

Model No.	Power	Dimension	Input	Efficacy	Lumens	Ra	Color	Control
FMB10	15W	10"	120Vac	80LM/W	1200LM	>80	3-CCT Switchable RGBCW Adjustable	Triac Dim Bluetooth WIFI
FMB12	20W	12"	120Vac	80LM/W	1600LM	>80		
FMB14	24W	14"	120Vac	80LM/W	1920LM	>80		
FMB16	28W	16"	120Vac	80LM/W	2240LM	>80		

# FMC

## Flush Mount Ceiling Light

- 3-CCT Switchable
- Smart Control
- Voice Control

21/



## A : 3-CCT Switchable +Change Mode optional

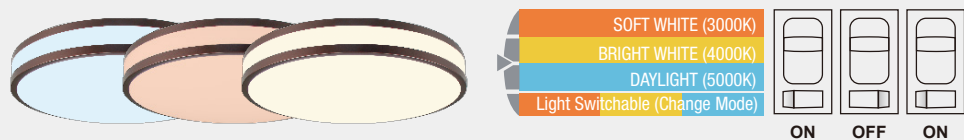

## W2: WIFI Smart with RGBCW adjustable

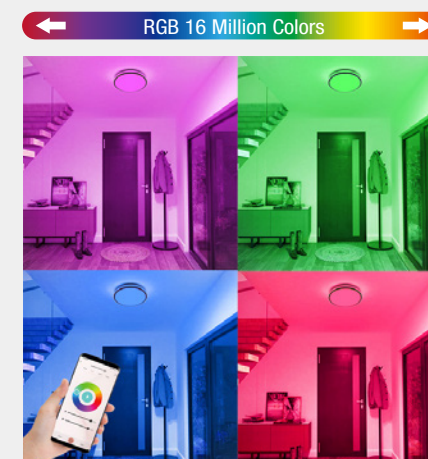
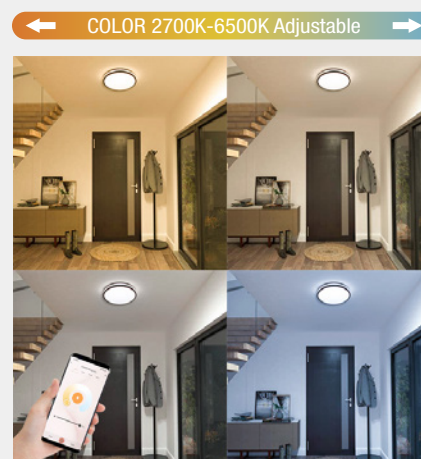
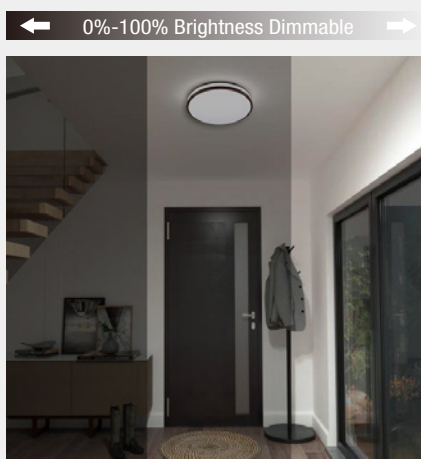
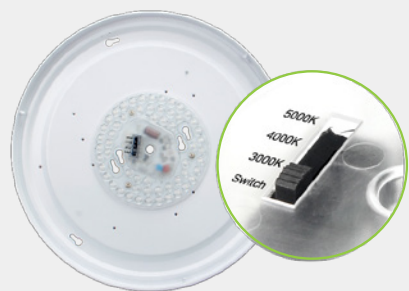
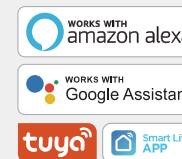
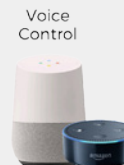

## Parameter

Model No.	Power	Dimension	Input	Efficacy	Lumens	Ra	Color	Control
FMC12	20W	12"	120Vac	80LM/W	1600LM	>80	3-CCT Switchable RGBCW Adjustable	Triac Dim Bluetooth WIFI
FMC14	24W	14"	120Vac	80LM/W	1920LM	>80		
FMC16	28W	16"	120Vac	80LM/W	2240LM	>80		



# LED DOWN LIGHT



22

Gimbal

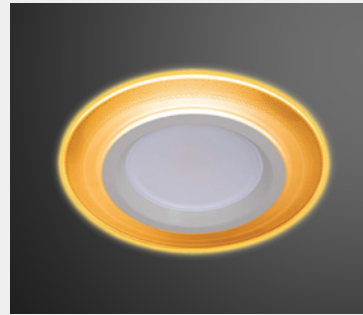

23

DLE



24

DLD  
(Canless)



25

DLA  
(Retrofit)



26

DLD-W & DLA-W  
(Smart)

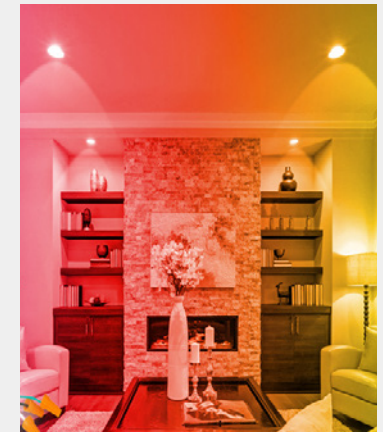
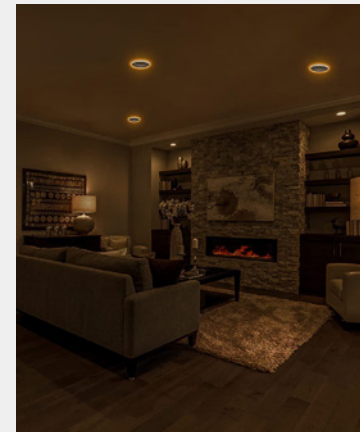
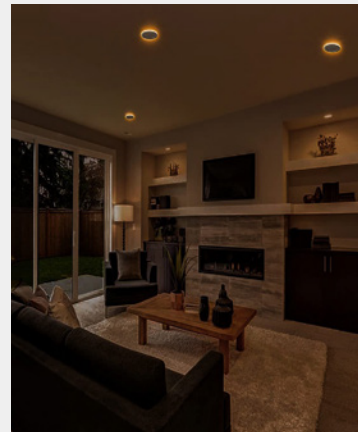

# GIMBAL 360°

2.5" 3.5" 4" 6" Downlight

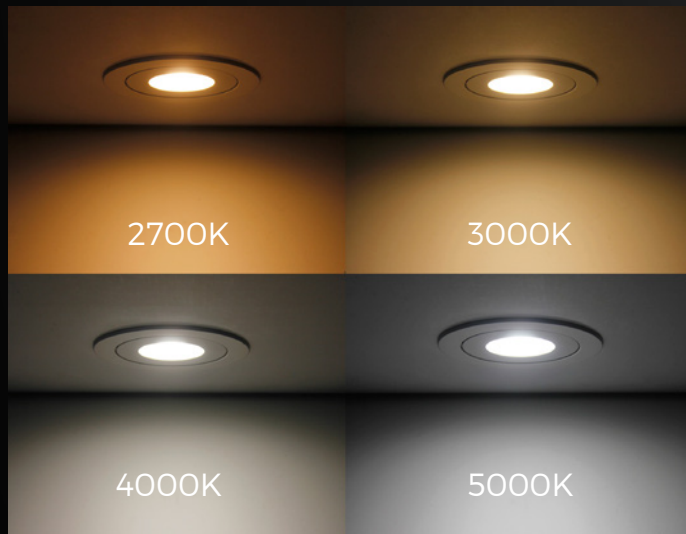

## 360° ROTATION



## High Quality Driver



## 80° TILT



## 5-CCT Selectable

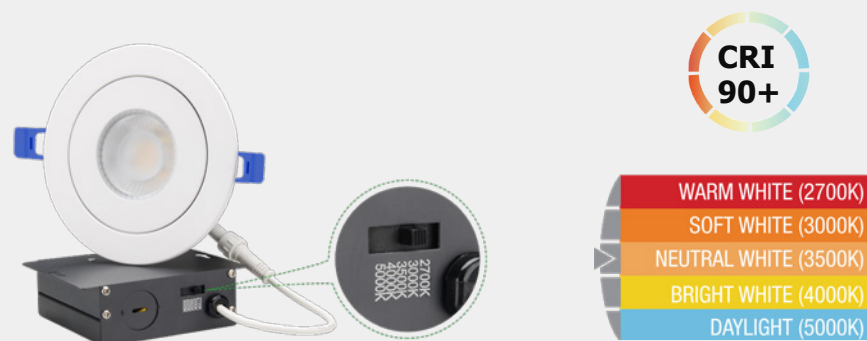

## Parameter

Model No.	Power	Size	Input	Efficacy	Lumens	Ra	Beam Angle	CCT	Control
2.5GD5W-5CCT	5W	2.5"	120Vac	80lm/w	400LM	>90	25°	5-CCT Switchable	Triac Dim
T18GD7W-CCT	7W	3.5"	120Vac	70lm/w	500LM	>90	36°		
T18RD9W-CCT	9W	4"	120Vac	75lm/w	650LM	>90	36°		
T18RD15W-CCT	15W	6"	120Vac	80lm/w	1200LM	>90	36°		

# DLE Nightlight

4" 6' Canless Downlight



## Downlight & Nightlight Model

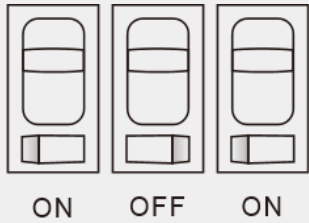
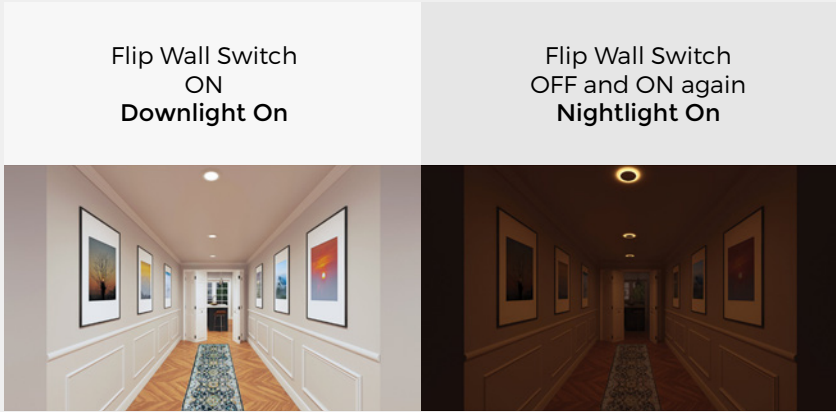

Flip wall switch/ dimmer switch  
ON/OFF/ON  
under 3 seconds to change  
Downlight Mode/Nightlight Mode

## High Quality Driver

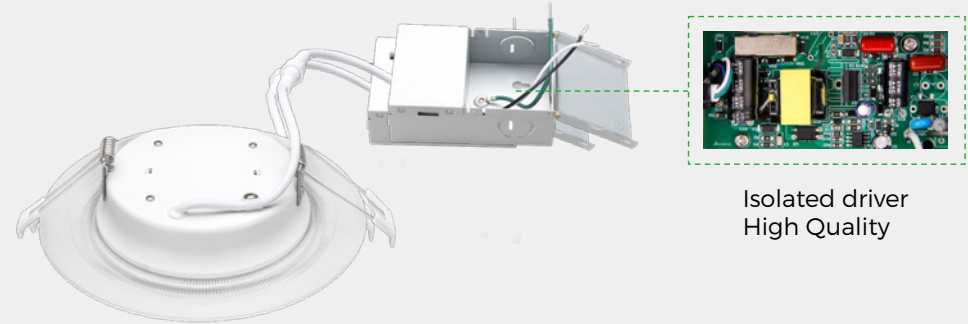

Isolated driver  
High Quality

## 5-CCT Switchable (for Downlight)



Baffle Trim for Anti-glare



## Parameter

Model No.	Power	Size	Input	Efficacy	Lumens	Ra	Beam Angle	CCT	Control
DLE-04-10-6CT	10W+4W	4"	120Vac	100lm/w	1000LM	>80	120°	5 -CCT Switchable + Night Light 2000K	0-10V Triac Dim
DLF-06-14-6CK	14W+4W	4"	120Vac	110lm/w	1550LM	>80	120°		

# DLD

24/

## Canless Down Light

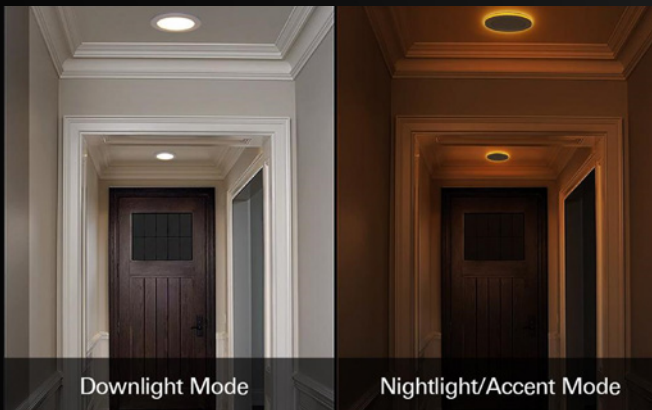

## 5-Color Switchable

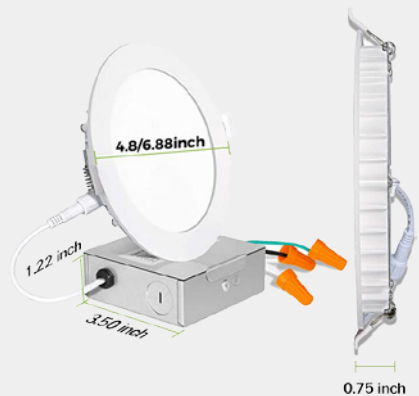

## Canless Installation

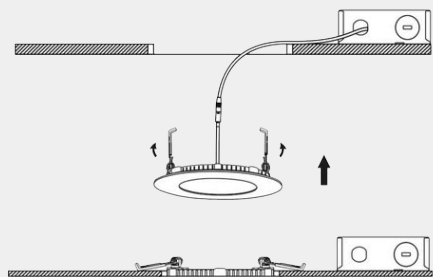

## Parameter

Type	Model No.	Power	Dimension	Input	Lumens	Ra	Main Light	Night Light	Control
Without Nightlight	DLD-04-11-5CK	10.5W	4"	120Vac	850LM	>90	5-CCT Switchable	without Nigh Light	Triac Dim
	DLD-06-14-5CK	14W	6"	120Vac	1200LM	>90			
	DLD-08-27-5CT	25W	8"	120Vac	2100LM	>80			
With Nightlight	DLD-04-11-5CK(B)	10.5+2W	4"	120Vac	850LM	>90	5-CCT Switchable	2000K RGB	Triac Dim
	DLD-06-14-5CK(B)	14+4W	6"	120Vac	1200LM	>90			
	DLD-08-27-6CT	25+4W	8"	120Vac	2100LM	>80			

## 2000K Night Light



Activate the light fixture.



Turn off the light fixture.

## RGB Night Light



Activate night light mode.

# DLA

25/

## Recessed Can Retrofit Downlight





## 5-Color Switchable

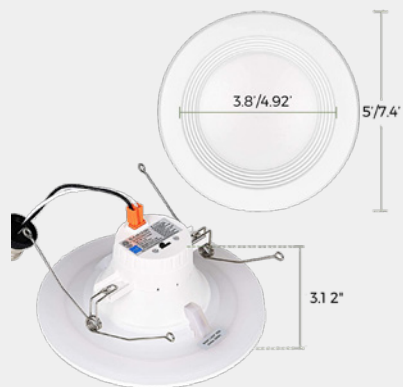

## Canless Installation



## Parameter

Type	Model No.	Power	Dimension	Input	Lumens	Ra	Main Light	Night Light	Control
Without Nightlight	DLA-04-11-5CK	11W	4"	120Vac	850LM	>90	5-CCT Switchable	without Nigh Light	Triac Dim
	DLA-06-15-5CK	15W	5"/6"	120Vac	1200LM	>90			
With Nightlight	DLA-04-11-5CK(B)	11W+2W	4"	120Vac	850LM	>90	5-CCT Switchable	2000K RGB	Triac Dim
	DLA-06-15-5CK(B)	15W+2W	5"/6"	120Vac	1200LM	>90			

## 2000K Night Light



Activate the light fixture.



Turn off the light fixture.

## RGB Night Light



Activate night light mode.

# DLD-W & DLA-W

## Smart Down Light

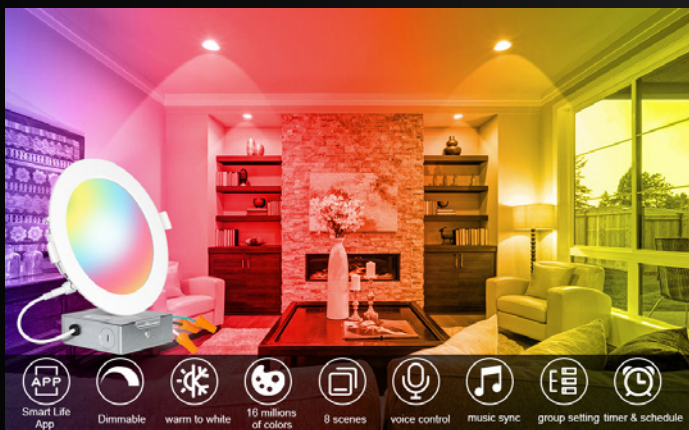

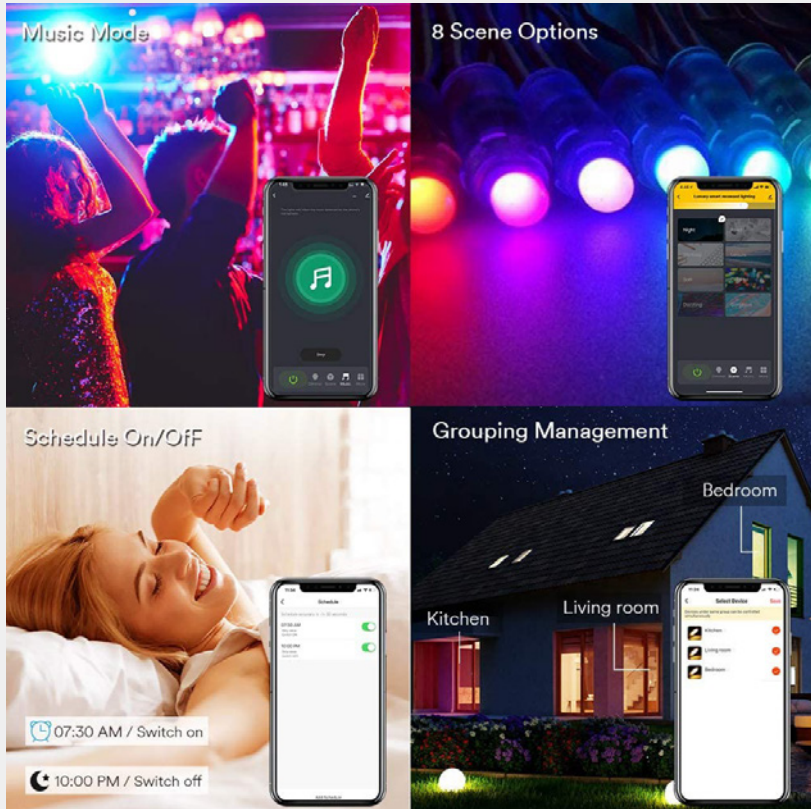

## With APP Control

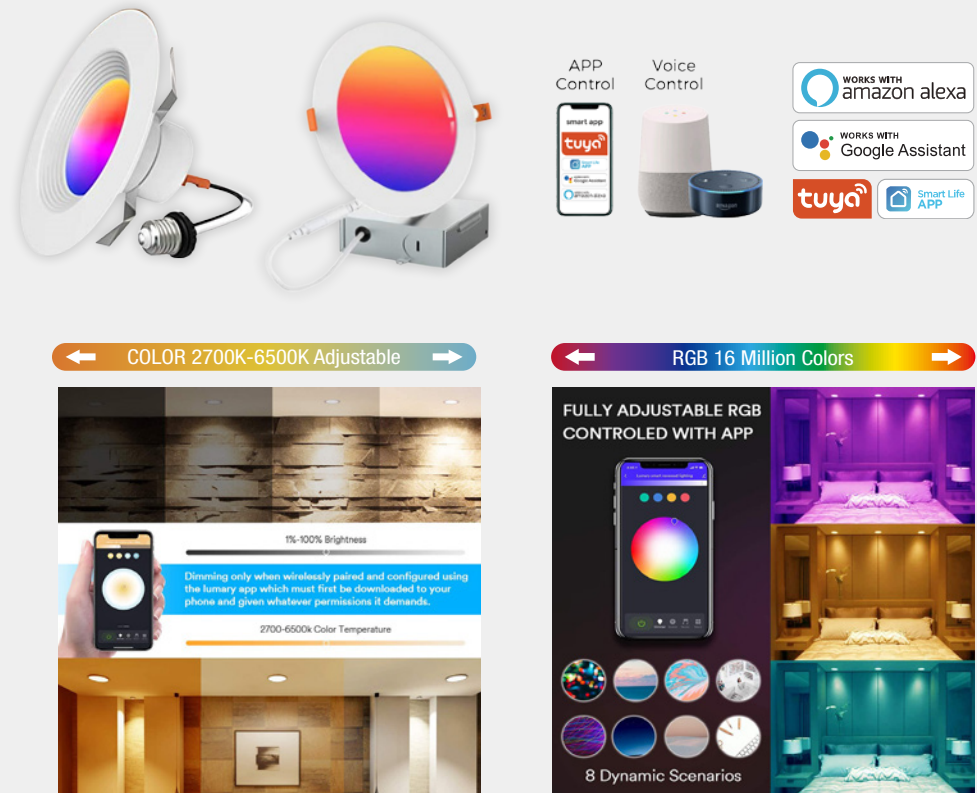

## Smart with RGBCW adjustable



## Parameter

Type	Model No.	Power	Dimension	Input	Lumens	Ra	Main Light	Control
	DLD-04-11-RGB(W)	10.5W	4"	120Vac	850LM	>90	2700K-6500K +RGB	WIFI Bluetooth
	DLD-06-14-RGB(W)	14W	6"	120Vac	1200LM	>90		
	DLA-04-11-RGB(W)	11W	4"	120Vac	850LM	>90		
	DLA-06-15-RGB(W)	15W	5"/6"	120Vac	1200LM	>90		