



HALCON
LIGHTING
FOR THE FUTURE



**LIGHTING
FOR THE FUTURE**

WWW.HALCONLIGHTING.COM
Zhongshan Halcon Lighting & Electrical Co.,Ltd



中山市宏跃照明电器有限公司

Zhongshan Halcon Lighting & Electrical Co.,Ltd

地址: 广东省中山市横栏镇顺兴北路9号银城工业园D栋1-4楼
Add: Floor #1-4, Building D, YinCheng Industrial Park, No 9 ShunXin North Road,
HengLan Town, ZhongShan City, GuangDong, China.

Tel: +86-760-87556293/87556292/87556295
Fax: +86-760-87619637
What's App: 008613823943056
Postcode: 528478

SKYPE: emilymao_zs
Wechat: emilymao316
E-mail: emily@halconlighting.com
Website: www.halconlighting.com

sales1@halconlighting.com
sales03@halconlighting.com
sales02@halconlighting.com
sales04@halconlighting.com

公司简介

Company Introduction

中山市宏跃照明电器有限公司是一家与出口及内销灯具产品的民营企业，地处中山市横栏镇永兴工业区，专业生产LED办公照明、LED商业照明、LED厨房灯、LED仓库灯及其他LED工业用灯等。

公司设有冲压、挤塑及组装等车间，能独立完成模具设计、制造、冲压、机械加工、灯具装配等一系列工序。主要设备有五金冲压设备、五金成型设备、灯具装配流水线等。

公司目前年生产能力为50万个灯具、50吨各类铝、铁质的灯具产品。员工100人，其中冲压设计、工艺的工程技术人员有10人，员工素质良好。

公司一贯重视新品的研发和品质的控制。凭借国外先进的技术和信息，设计研发了一大批技术含量高、外观新颖、适销对路的新产品，每年有近十几种的新品推向市场；公司产品先后通过CE、UL、CUL、DLC等国际安全认证。

公司享有自营进出口权，能独立向国外用户建立良好的合作关系，公司产品已销往包括美国、欧洲、澳洲、中东、南美、非洲等65个国家和地区，已建立全球性的销售网络。

公司推行现代化管理，有比较完善的管理网络和管理制度，对供、产、销、人、财、物各个环节采用软件管理，全方位整合企业的资源，提高公司内部的动作效率，更快更好地应对市场的变化，提升企业的综合竞争力。

公司始终坚持“细节生产、真诚奉献”的经营思想，全体员工共同努力，积极在产品、环境绩效、管理上持续改进、不断创新，使得公司、顾客、社会都能够分享最终的成果，确保公司及社会的可持续发展。

Company Review:

ZhongShan Halcon Lighting was founded on 2010, a professional manufacturer of commercial LED Lighting fixtures with 100 workers.

Our main products are LED Recessed Lights, LED Troffers, LED Linear pendant lights, LED Linear High Bay, LED Light Bar, LED Strip lights & LED Ceiling lights.

90% of our LED products are UL, ETL, Energy Star, SAA & FCC certified with 5 years warranty.

We have our own Hardware Department, Assembly Department & Testing Room.

For Hardware Department, we can produce all types of steel parts, alluminum parts for LED lighting. We have Punching process, Bending process, Soldering process and Laser Cutting process. Every steel parts of the LED lighting is made in house by ourselves.

For Testing Room, we have 1.75 M Photometric integrating sphere ball for the famous Everfine Brand. We also have G200- Goniophotometer to do IES file testing on all of the LED products.

On the Quality Control system, we have aging-test room to do 4-6 hours light-on test for every pieces lights, hi-pot test, light-distribution test, drop test, Vibration test & integrating sphere test before shipping.

We mostly sell our products to Europe, USA, Canada, Australia & New Zealand Markets. Halcon is committed to design, develop and manufacturing the innovative commercial LED light fixture with High quality to our clients.



UL file number: E477853 E481823 E482604



www.halconlighting.com

CONTENTS

目录

LED LINEAR HIGH BAY 01-07

LED VAPOR LIGHT 08-16

LED LINEAR LIGHT 17-30

LED TROFFER 31-60

UP AND DOWN LED LIGHT 61-64

LED PENDANT LIGHT 65-74

LED CEILING LIGHT 75-79

LED CABINET LIGHT 80-83

LED DOWN LIGHT 84-92



LED LINEAR HIGH BAY

Halcon Lighting - LED LINEAR HIGH BAY LIGHT

LED high bay lights are the perfect energy-efficient indoor lighting solution for industrial and commercial locations with high ceilings, like warehouses, gyms, barns, and supermarkets. No matter the reflector type (aluminum, prismatic, clear lens) High bay LED lights offer broad light distribution for these large areas, without any mercury or UV emittance.

Halcon lighting



LED LINEAR HIGH BAY

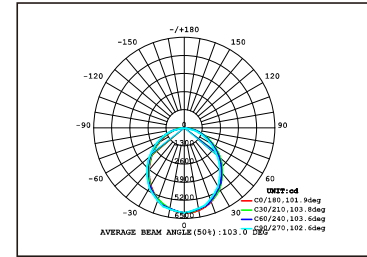
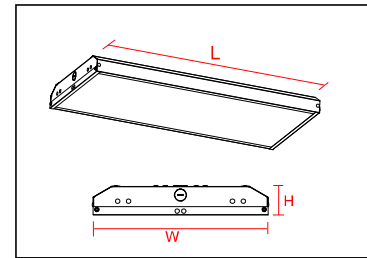

ELECTRICAL COMPONENT

Osram, Philips, Tridonic or meanwell LED driver for 120V-277V/60Hz, 347V/60Hz, 240V/50Hz
Ideal or WAGO UL/CUL approved quick disconnect VDE approved terminal block
Everlight or Samsung LED Chips

SPECIFICATION

Housing: 0.6mm pressed & folded steel sheet with epoxy powder coated finish
Diffuser: milky Acrylic material
with 1 meter hanging chains V hooks for suspension

OPTION

Available for installing with dimmable & emergency kits
Available for installing with sensor
Available for wire guard
Available for frosted acrylic lens

APPLICATION

Ware House / Shopping Store / 4s Car Store / Gymnasiums

MODEL	WATTS	LUMEN	LED TYPE	LAMP SIZE (L X W X H)	PACKAGE SIZE	PCS/CTN
HG-L225-80W/2ft	80W	10800 LM	SMD 2835	606X320X52.5mm	645x135x355mm	2
HG-L225-100W/2ft	100W	13500 LM	SMD 2835	606X320X52.5mm	645x135x355mm	2
HG-L225-140W/2ft	140W	18900 LM	SMD 2835	606x320x52.5mm	645x135x355mm	2
HG-L225-165W/2ft	165W	22275 LM	SMD 2835	606x440x52.5mm	645x135x475mm	2
HG-L225-220W/2ft	220W	29700 LM	SMD 2835	606x440x52.5mm	645x135x475mm	2

LED LINEAR HIGH BAY

LED LINEAR HIGH BAY

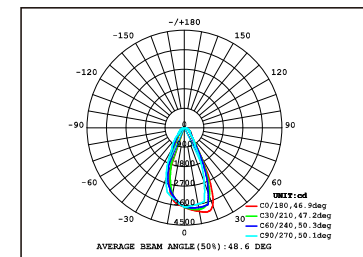
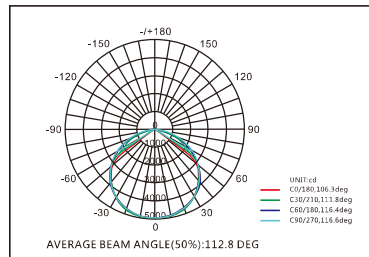
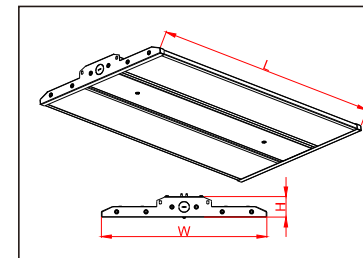
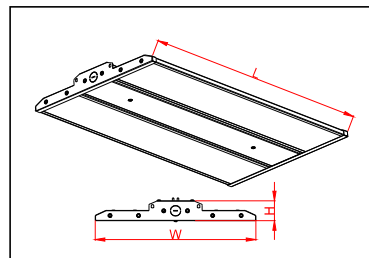

ELECTRICAL COMPONENT

Osram, Philips, Tridonic or meanwell LED driver for 120V-277V/60Hz, 347V/60Hz, 240V/50Hz
 Ideal or WAGO UL/CUL approved quick disconnect VDE approved terminal block
 Everlight or Samsung LED Chips

SPECIFICATION

Housing: 0.6mm pressed & folded steel sheet with epoxy powder coated finish
 Diffuser: milky Acrylic material
 with 1 meter hanging chains V hooks for suspension

OPTION

Available for installing with dimmable & emergency kits
 Available for installing with sensor
 Available for wire guard
 Available for frosted acrylic lens

APPLICATION

Ware House / Shopping Store / 4s Car Store / Gymnasiums

ELECTRICAL COMPONENT

Osram, Philips, Tridonic or meanwell LED driver for 120V-277V/60Hz, 347V/60Hz, 240V/50Hz
 Ideal or WAGO UL/CUL approved quick disconnect VDE approved terminal block
 Everlight or Samsung LED Chips

SPECIFICATION

Housing: 0.6mm pressed & folded steel sheet with epoxy powder coated finish
 Diffuser: milky Acrylic material
 with 1 meter hanging chains V hooks for suspension

OPTION

Available for installing with dimmable & emergency kits
 Available for installing with sensor
 Available for wire guard
 Available for frosted acrylic lens

APPLICATION

Ware House / Shopping Store / 4s Car Store / Gymnasiums

MODEL	WATTS	LUMEN	LED TYPE	LAMP SIZE (LxWxH)	PACKAGE SIZE	PCS/CTN
HG-L225C-80W/2ft	80W	10800 LM	SMD 2835	600x338x42mm	385x115x645mm	2
HG-L225C-100W/2ft	100W	13500 LM	SMD 2835	600x338x42mm	385x115x645mm	2
HG-L225C-140W/2ft	140W	18900 LM	SMD 2835	600x338x42mm	385x115x645mm	2
HG-L225C-165W/2ft	165W	22275 LM	SMD 2835	600x448x42mm	495x115x645mm	2
HG-L225C-220W/2ft	220W	29700 LM	SMD 2835	600x448x42mm	495x115x645mm	2

MODEL	WATTS	LUMEN	LED TYPE	LAMP SIZE (LxWxH)	PACKAGE SIZE	PCS/CTN
HG-L225C-165W/4ft	165W	22275 LM	SMD 2835	1160x338x42mm	385x115x1210mm	2
HG-L225C-225W/4ft	225W	30375 LM	SMD 2835	1160x338x42mm	385x115x1210mm	2
HG-L225C-325W/4ft	325W	43875 LM	SMD 2835	1160x448x42mm	495x115x1210mm	2

LED LINEAR HIGH BAY

LED LINEAR HIGH BAY

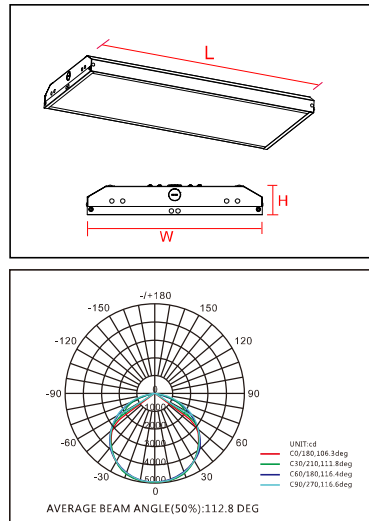

ELECTRICAL COMPONENT

Osram, Philips, Tridonic or meanwell LED driver for 120V-277V/60Hz, 347V/60Hz, 240V/50Hz
 Ideal or WAGO UL/CUL approved quick disconnect VDE approved terminal block
 Everlight or Samsung LED Chips

SPECIFICATION

Housing: 0.6mm pressed & folded steel sheet with epoxy powder coated finish
 Diffuser: milky Acrylic material
 with 1 meter hanging chains V hooks for suspension

OPTION

Available for installing with dimmable & emergency kits
 Available for installing with sensor
 Available for wire guard
 Available for frosted acrylic lens

APPLICATION

Ware House / Shopping Store / 4s Car Store / Gymnasiums

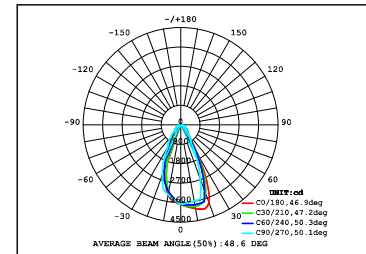
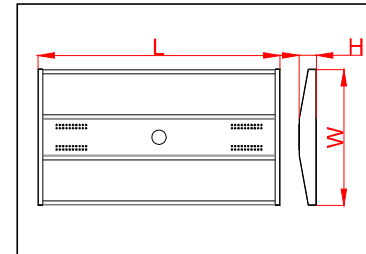

ELECTRICAL COMPONENT

Osram, Philips, Tridonic or meanwell LED driver for 120V-277V/60Hz, 347V/60Hz, 240V/50Hz
 Ideal or WAGO UL/CUL approved quick disconnect VDE approved terminal block
 Everlight or Samsung LED Chips

SPECIFICATION

Housing: 0.6mm pressed & folded steel sheet with epoxy powder coated finish
 Diffuser: milky Acrylic material
 with 1 meter hanging chains V hooks for suspension

OPTION

Available for installing with dimmable & emergency kits
 Available for installing with sensor
 Available for wire guard
 Available for frosted acrylic lens

APPLICATION

Ware House / Shopping Store / 4s Car Store / Gymnasiums

MODEL	WATTS	LUMEN	LED TYPE	LAMP SIZE (LxWxH)	PACKAGE SIZE	PCS/CTN
HG-L225-165W/4ft	165W	22275 LM	SMD 2835	1165x320x52.5mm	355x135x1210mm	2
HG-L225-225W/4ft	225W	30375 LM	SMD 2835	1165x320x52.5mm	355x135x1210mm	2
HG-L225-325W/4ft	325W	43875 LM	SMD 2835	1165x440x52.5mm	475x135x1210mm	2

MODEL	WATTS	LUMEN	LED TYPE	LAMP SIZE (LxWxH)	PACKAGE SIZE	PCS/CTN
P2009-80W/2ft	80W	10800 LM	SMD 2835	590x332x42mm	365x110x630mm	2
P2009-100W/2ft	100W	13500 LM	SMD 2835	590x332x42mm	365x110x630mm	2
P2009-140W/2ft	140W	18900 LM	SMD 2835	590x332x42mm	365x110x630mm	2
P2009-165W/2ft	165W	22275 LM	SMD 2835	590x442x42mm	475x110x630mm	2
P2009-220W/2ft	220W	29700 LM	SMD 2835	590x442x42mm	475x110x630mm	2

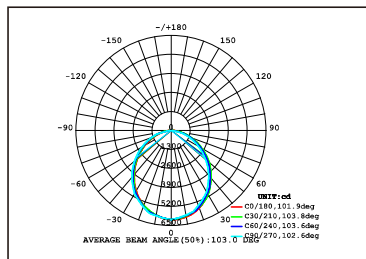
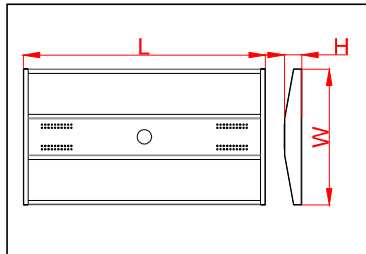

ELECTRICAL COMPONENT

Osram, Philips, Tridonic or meanwell LED driver for 120V-277V/60Hz, 347V/60Hz, 240V/50Hz
 Ideal or WAGO UL/CUL approved quick disconnecter VDE approved terminal block
 Everlight or Samsung LED Chips

SPECIFICATION

Housing: 0.6mm pressed & folded steel sheet with epoxy powder coated finish
 Diffuser: milky Acrylic material
 with 1 meter hanging chains V hooks for suspension

OPTION

Available for installing with dimmable & emergency kits
 Available for installing with sensor
 Available for wire guard
 Available for frosted acrylic lens

APPLICATION

Ware House / Shopping Store / 4s Car Store / Gymnasiums



Halcon Lighting -LED VAPOR LIGHT

LED Vapor Tight Lights are durable enclosed fixtures that are built for rugged environments. They can withstand exposure to water and vapor, making these LEDs great for food service areas, airports, tunnels, maintenance areas, parking garages, and stairwells

MODEL	WATTS	LUMEN	LED TYPE	LAMP SIZE (LxWxH)	PACKAGE SIZE	PCS/CTN
P2009-165W/4ft	165W	22275 LM	SMD 2835	1150x332x42mm	365x110x1190mm	2
P2009-225W/4ft	225W	30375 LM	SMD 2835	1150x332x42mm	365x110x1190mm	2
P2009-325W/4ft	325W	43875 LM	SMD 2835	1150x442x42mm	475x110x1190mm	2

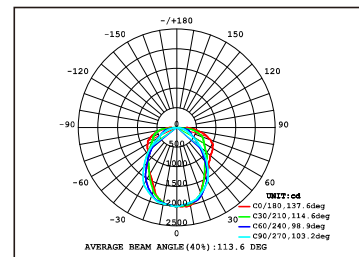
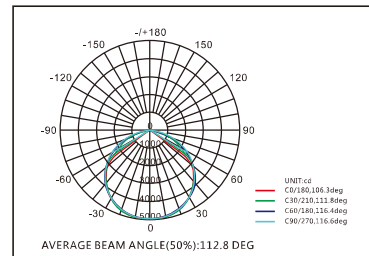
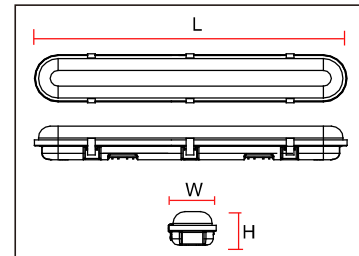
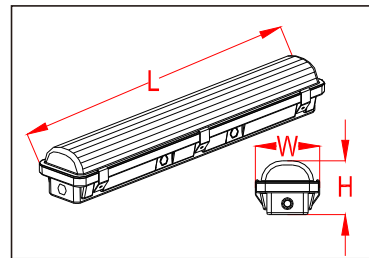

ELECTRICAL COMPONENT

Osram, Philips, Tridonic or meanwell LED driver for 120V-277V/60Hz, 347V/60Hz, 240V/50Hz
 Ideal or WAGO UL/CUL approved quick disconnecter VDE approved terminal block
 Everlight or Samsung LED Chips

SPECIFICATION

High-diffusion light-milky PC diffuser
 Grey PC plastic housing with UV rating
 0.5mm steel sheet gear tray with white powder coated

OPTION

Available for installing with dimmable & emergency kits
 Available for installing with sensor
 Available for hanging

APPLICATION

Shop / School / Office / Hotel / Conference Room / Hospital

ELECTRICAL COMPONENT

Osram, Philips, Tridonic or meanwell LED driver for 120V-277V/60Hz, 347V/60Hz, 240V/50Hz
 Ideal or WAGO UL/CUL approved quick disconnecter VDE approved terminal block
 Everlight or Samsung LED Chips

SPECIFICATION

High-diffusion light-milky PC diffuser
 Grey PC plastic housing with UV rating
 0.5mm steel sheet gear tray with white powder coated

OPTION

Available for installing with dimmable & emergency kits
 Available for installing with sensor
 Available for hanging

APPLICATION

Shop / School / Office / Hotel / Conference Room / Hospital

MODEL	WATTS	LUMEN	LED TYPE	LAMP SIZE (L X W X H)	PACKAGE SIZE	PCS/CTN
C2103-252F	15/20/25W	3000 LM	SMD2835	600x110x88mm	680x305x250mm	6
C2103-504F	30/40/50W	6000 LM	SMD2835	1200x110x88mm	1280x305x250mm	6
C2103-804F	60/70/80W	9600 LM	SMD2835	1200x110x88mm	1280x305x250mm	6
C2103-1008F	80/90/100W	12000 LM	SMD2835	2385x110x88mm	2470x210x250mm	4

MODEL	WATTS	LUMEN	LED TYPE	LAMP SIZE (L X W X H)	PACKAGE SIZE	PCS/CTN
HG-L223-252F	25W	3000 LM	SMD2835	600x110x88mm	630x305x280mm	6
HG-L223-404F	40W	4800 LM	SMD2835	1200x110x88mm	1230x305x280mm	6
HG-L223-604F	60W	7200 LM	SMD2835	1200x110x88mm	1230x305x280mm	6



ELECTRICAL COMPONENT

Osram, Philips, Tridonic or meanwell LED driver for 120V-277V/60Hz, 347V/60Hz, 240V/50Hz
 Ideal or WAGO UL/CUL approved quick disconnect VDE approved terminal block
 Everlight or Samsung LED Chips

SPECIFICATION

High-diffusion light-milky PC diffuser
 Grey PC plastic housing with UV rating
 0.5mm steel sheet gear tray with white powder coated

OPTION

Available for installing with dimmable & emergency kits
 Available for installing with sensor
 Available for hanging

APPLICATION

Shop / School / Office / Hotel / Conference Room / Hospital

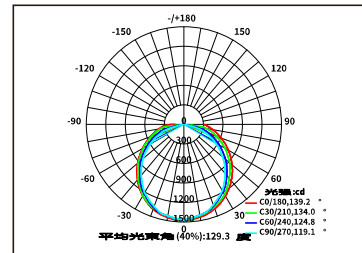
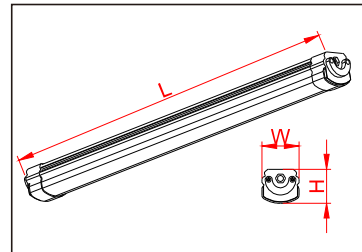

ELECTRICAL COMPONENT

Osram, Philips, Tridonic or meanwell LED driver for 120V-277V/60Hz, 347V/60Hz, 240V/50Hz
 Ideal or WAGO UL/CUL approved quick disconnect VDE approved terminal block
 Everlight or Samsung LED Chips

SPECIFICATION

High-diffusion light-milky PC diffuser
 Grey PC plastic housing with UV rating
 0.5mm steel sheet gear tray with white powder coated

OPTION

Available for installing with dimmable & emergency kits
 Available for installing with sensor
 Available for hanging

APPLICATION

Shop / School / Office / Hotel / Conference Room / Hospital

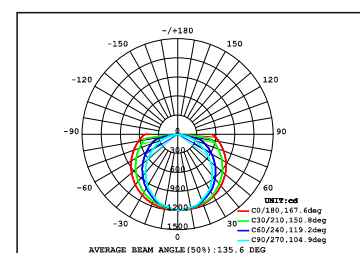
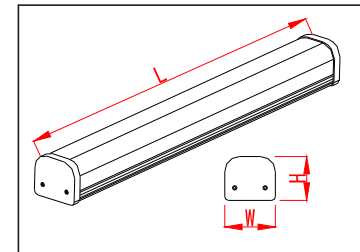

MODEL	WATTS	LUMEN	LED TYPE	LAMP SIZE (LxWxH)	PACKAGE SIZE	PCS/CTN
C2003-304F	30W	3900 LM	SMD2835	1260x63x58mm	1305x220x155mm	6
C2003-364F	36W	4680 LM	SMD2835	1260x63x58mm	1305x220x155mm	6
C2003-605F	60W	7800 LM	SMD2835	1560x63x58mm	1605x220x155mm	6
C2003-808F	80W	10400 LM	SMD2835	2440x63x58mm	2480x220x155mm	6

MODEL	WATTS	LUMEN	LED TYPE	LAMP SIZE (LxWxH)	PACKAGE SIZE	PCS/CTN
C2004-4ft/30W	30W	3600 LM	SMD2835	1183x73x63mm	1220x215x170mm	6
C2004-4ft/40W	40W	4800 LM	SMD2835	1183x73x63mm	1220x215x170mm	6
C2004-5ft/60W	60W	7200 LM	SMD2835	1480x73x63mm	1520x215x170mm	6



ELECTRICAL COMPONENT

Osram, Philips, Tridonic or meanwell LED driver for 120V-277V/60Hz, 347V/60Hz, 240V/50Hz
 Ideal or WAGO UL/CUL approved quick disconnect VDE approved terminal block
 Everlight or Samsung LED Chips

ELECTRICAL COMPONENT

Osram, Philips, Tridonic or meanwell LED driver for 120V-277V/60Hz, 347V/60Hz, 240V/50Hz
 Ideal or WAGO UL/CUL approved quick disconnect VDE approved terminal block
 Everlight or Samsung LED Chips

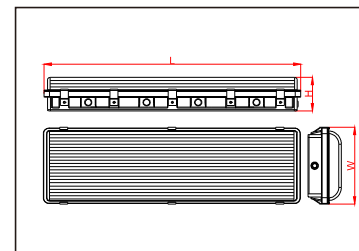
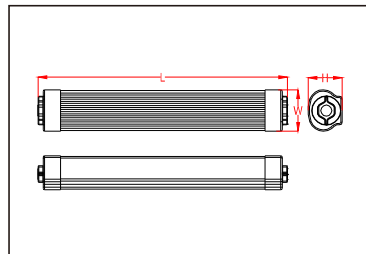

SPECIFICATION

High-diffusion light-milky PC diffuser
 Grey PC plastic housing with UV rating
 0.5mm steel sheet gear tray with white powder coated

SPECIFICATION

High-diffusion light-milky PC diffuser
 Grey PC plastic housing with UV rating
 0.5mm steel sheet gear tray with white powder coated

OPTION

Available for installing with dimmable & emergency kits
 Available for installing with sensor
 Available for hanging

OPTION

Available for installing with dimmable & emergency kits
 Available for installing with sensor
 Available for hanging

APPLICATION

Shop / School / Office / Hotel / Conference Room / Hospital

APPLICATION

Shop / School / Office / Hotel / Conference Room / Hospital

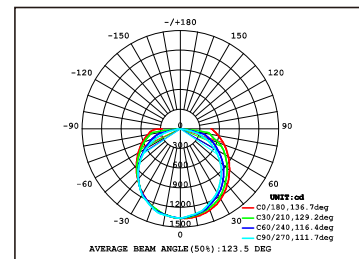
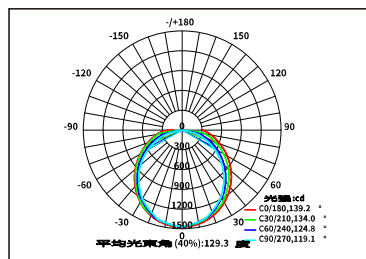

MODEL	WATTS	LUMEN	LED TYPE	LAMP SIZE (L X W X H)	PACKAGE SIZE	PCS/CTN
C2301-4ft/30W	30W	3600 LM	SMD2835	1225x86x71mm	1280x245x200mm	6
C2301-4ft/40W	40W	4800 LM	SMD2835	1225x86x71mm	1240x245x200mm	6
C2301-5ft/60W	60W	7200 LM	SMD2835	1500x86x71mm	1540x245x200mm	6
C2301-6ft/80W	80W	9600 LM	SMD2835	2438x86x71mm	2440x245x200mm	6

MODEL	WATTS	LUMEN	LED TYPE	LAMP SIZE (L X W X H)	PACKAGE SIZE	PCS/CTN
C2202-4ft/80W	80W	10000 LM	SMD2835	1200x260x110mm	1235x365x285mm	3
C2202-4ft/100W	100W	12500 LM	SMD2835	1200x260x110mm	1235x365x285mm	3



ELECTRICAL COMPONENT

Osram, Philips, Tridonic or meanwell LED driver for 120V-277V/60Hz, 347V/60Hz, 240V/50Hz
 Ideal or WAGO UL/CUL approved quick disconnect VDE approved terminal block
 Everlight or Samsung LED Chips

SPECIFICATION

High-diffusion light-milky PC diffuser
 Grey PC plastic housing with UV rating
 0.5mm steel sheet gear tray with white powder coated

OPTION

Available for installing with dimmable & emergency kits
 Available for installing with sensor
 Available for hanging

APPLICATION

Shop / School / Office / Hotel / Conference Room / Hospital

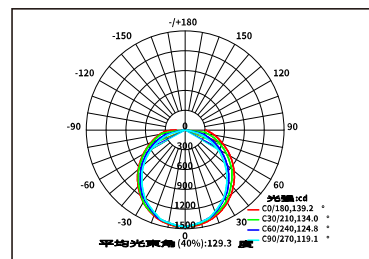
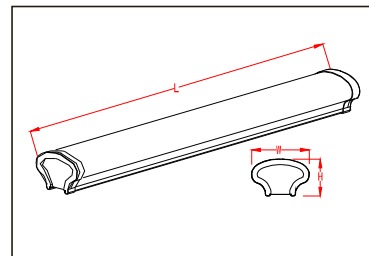

MODEL	WATTS	LUMEN	LED TYPE	LAMP SIZE (L X W X H)	PACKAGE SIZE	PCS/CTN
C2005-4ft/30W	30W	3600 LM	SMD2835	1200x98x63mm	1240x220x230mm	6
C2005-4ft/40W	40W	4800 LM	SMD2835	1200x98x63mm	1240x220x230mm	6
C2005-5ft/60W	60W	7200 LM	SMD2835	1500x98x63mm	1540x220x230mm	6
C2005-6ft/80W	80W	9600 LM	SMD2835	2400x98x63mm	2440x220x230mm	6



ELECTRICAL COMPONENT

Osram, Philips, Tridonic or meanwell LED driver for 120V-277V/60Hz, 347V/60Hz, 240V/50Hz
 Ideal or WAGO UL/CUL approved quick disconnect VDE approved terminal block
 Everlight or Samsung LED Chips

SPECIFICATION

High-diffusion light-milky PC diffuser
 Grey PC plastic housing with UV rating
 0.5mm steel sheet gear tray with white powder coated

OPTION

Available for installing with dimmable & emergency kits
 Available for installing with sensor
 Available for hanging

APPLICATION

Shop / School / Office / Hotel / Conference Room / Hospital

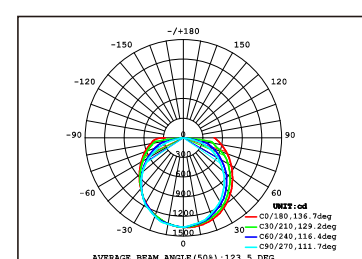
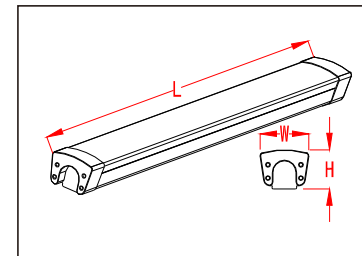

MODEL	WATTS	LUMEN	LED TYPE	LAMP SIZE (L X W X H)	PACKAGE SIZE	PCS/CTN
C2006-4ft/30W	30W	3600 LM	SMD2835	1195x90x72mm	1235x245x200mm	6
C2006-4ft/40W	40W	4800 LM	SMD2835	1195x90x72mm	1235x245x200mm	6
C2006-5ft/60W	60W	7200 LM	SMD2835	1495x90x72mm	1535x245x200mm	6



LED LINEAR LIGHT

LED LINEAR LIGHT



ELECTRICAL COMPONENT

Osram, Philips, Tridonic or meanwell LED driver for 120V-277V/60Hz, 347V/60Hz, 240V/50Hz
Ideal or WAGO UL/CUL approved quick disconnect VDE approved terminal block
Everlight or Samsung LED Chips

SPECIFICATION

0.6mm pressed & folded steel sheet housing with epoxy powder coated finish
High-diffusion Light milky PC diffuser

OPTION

Available for installing with dimmable & emergency kits
Available for installing with sensor
Available for hanging

APPLICATION

Shop / School / Office / Hotel / Conference Room / Hospital

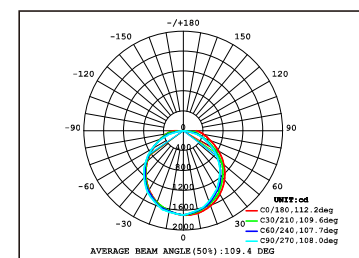
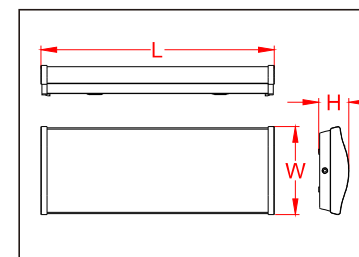

Halcon Lighting -LED LINEAR LIGHT

Create beautiful lighting in your office, residence, commercial building or industrial space with LED Linear lights from halconlighting.com. Our LED Linear lights are ideal for retail lighting since they provide a lovely diffused light that is visually comfortable.

MODEL	WATTS	LUMEN	LED TYPE	LAMP SIZE (LxWxH)	PACKAGE SIZE	PCS/CTN
HG-L201-20W/2ft	20W	2300 LM	SMD 2835	588X208X70mm	635x395x235mm	5
HG-L201-30W/4ft	30W	3450 LM	SMD 2835	1188x208x70mm	1230x395x235mm	5
HG-L201-40W/4ft	40W	4600 LM	SMD 2835	1188X208X70mm	1230x395x235mm	5
HG-L201-40W/5ft	40W	4600 LM	SMD 2835	1488x208x70mm	1530x395x235mm	5
HG-L201-60W/5ft	60W	6900 LM	SMD 2835	1488X208X70mm	1530x395x235mm	5
HG-L201-80W/6ft	80W	9200 LM	SMD 2835	1788x208x70mm	1830x395x235mm	5

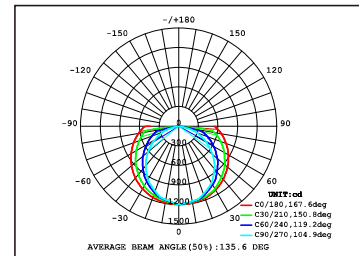
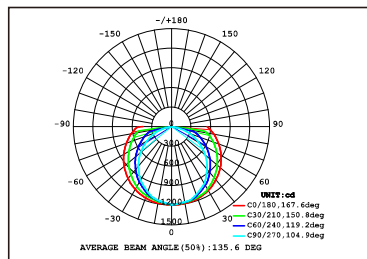
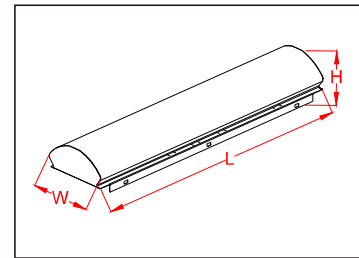
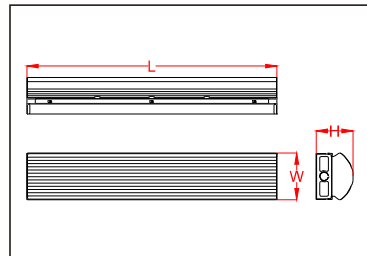

ELECTRICAL COMPONENT

Osram, Philips, Tridonic or meanwell LED driver for 120V-277V/60Hz, 347V/60Hz, 240V/50Hz
 Ideal or WAGO UL/CUL approved quick disconnect VDE approved terminal block
 Everlight or Samsung LED Chips

SPECIFICATION

Die formed of 0.5mm cold-rolled steel body
 All steel surface are painted after fabrication with high gloss backed white coated powder
 High reflectance backed white acrylic paint finished
 High-diffusion light-milky PC diffuser

OPTION

Available for installing with dimmable & emergency kits
 Available for installing with sensor
 Available for hanging

APPLICATION

Shop / School / Office / Hotel / Conference Room / Hospital

ELECTRICAL COMPONENT

Osram, Philips, Tridonic or meanwell LED driver for 120V-277V/60Hz, 347V/60Hz, 240V/50Hz
 Ideal or WAGO UL/CUL approved quick disconnect VDE approved terminal block
 Everlight or Samsung LED Chips

SPECIFICATION

Die formed of 0.6mm cold-rolled steel body
 All steel surface are painted after fabrication with high gloss backed white matte powder
 High reflectance backed white acrylic paint finished
 High-diffusion light-milky PC diffuser

OPTION

Available for installing with dimmable & emergency kits
 Available for installing with sensor

APPLICATION

Shop / School / Office / Hotel / Conference Room / Hospital

MODEL	WATTS	LUMEN	LED TYPE	LAMP SIZE (L X W X H)	PACKAGE SIZE	PCS/CTN
HG-L206-24W/4ft	24W	3120 LM	SMD 2835	1206x115x91mm	1245x270x220mm	4
HG-L206-40W/4ft	40W	5200 LM	SMD 2835	1206x115x91mm	1245x270x220mm	4
HG-L206-63W/8ft	63W	8190 LM	SMD 2835	2438x115x91mm	2480x270x220mm	4
HG-L206-85W/8ft	85W	11050 LM	SMD 2835	2438x115x91mm	2480x270x220mm	4

MODEL	WATTS	LUMEN	LED TYPE	LAMP SIZE (L X W X H)	PACKAGE SIZE	PCS/CTN
HG-L206R-244F	24W	3120 LM	SMD2835	1206x113x33mm	1245x270x200mm	4
HG-L206R-404F	40W	5200 LM	SMD2835	1206x113x33mm	1245x270x200mm	4
HG-L206R-468F	46W	5980 LM	SMD2835	2438x113x33mm	2480x270x220mm	4
HG-L206R-638F	63W	8190 LM	SMD2835	2438x113x33mm	2480x270x220mm	4
HG-L206R-858F	85W	11050 LM	SMD2835	2438x113x33mm	2480x270x220mm	4



ELECTRICAL COMPONENT

Osram, Philips, Tridonic or meanwell LED driver for 120V-277V/60Hz, 347V/60Hz, 240V/50Hz
 Ideal or WAGO UL/CUL approved quick disconnect VDE approved terminal block
 Everlight or Samsung LED Chips

SPECIFICATION

Die formed of 0.5mm cold-rolled steel body
 All steel surface are painted after fabrication with high gloss backed white coated powder
 High reflectance backed white acrylic paint finished
 High-diffusion light-milky PC diffuser

OPTION

Available for installing with dimmable & emergency kits
 Available for installing with sensor
 Available for hanging

APPLICATION

Shop / School / Office / Hotel / Conference Room / Hospital

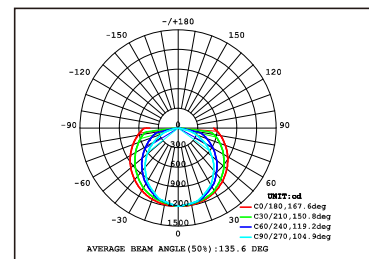
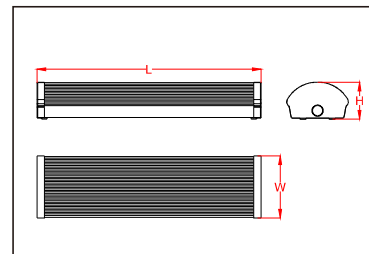

ELECTRICAL COMPONENT

Osram, Philips, Tridonic or meanwell LED driver for 120V-277V/60Hz, 347V/60Hz, 240V/50Hz
 Ideal or WAGO UL/CUL approved quick disconnect VDE approved terminal block
 Everlight or Samsung LED Chips

SPECIFICATION

Die formed of 0.5mm cold-rolled steel body
 All steel surface are painted after fabrication with high gloss backed white coated powder
 High reflectance backed white acrylic paint finished
 High-diffusion light-milky PC diffuser

OPTION

Available for installing with dimmable & emergency kits
 Available for installing with sensor
 Available for hanging

APPLICATION

Shop / School / Office / Hotel / Conference Room / Hospital

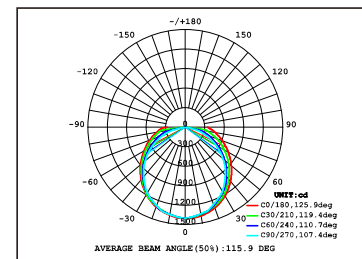
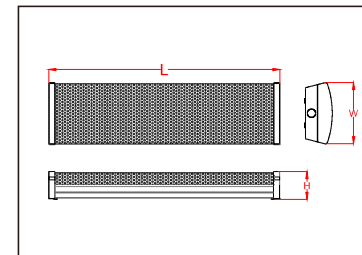

MODEL	WATTS	LUMEN	LED TYPE	LAMP SIZE (L X W X H)	PACKAGE SIZE	PCS/CTN
C1801-25W/2ft	25W	2875 LM	SMD 2835	585X127X75mm	640x420x150mm	5
C1801-36W/4ft	36W	4140 LM	SMD 2835	1198x127x75mm	1215x420x150mm	5
C1801-30W/5ft	30W	3450 LM	SMD 2835	1488x127x75mm	1510x420x150mm	5
C1801-60W/5ft	60W	6900 LM	SMD 2835	1488x127x75mm	1510x420x150mm	5
C1801-80W/6ft	80W	9200 LM	SMD 2835	1788x127x75mm	1810x420x150mm	5

MODEL	WATTS	LUMEN	LED TYPE	LAMP SIZE (L X W X H)	PACKAGE SIZE	PCS/CTN
C1802-25W/2ft	25W	2875 LM	SMD 2835	585x126x68mm	640x390x170mm	5
C1802-36W/4ft	36W	4140 LM	SMD 2835	1198x126x68mm	1215x390x170mm	5
C1802-30W/5ft	30W	3450 LM	SMD 2835	1485x126x68mm	1510x390x170mm	5
C1802-60W/5ft	60W	6900 LM	SMD 2835	1485x126x68mm	1510x390x170mm	5
C1802-80W/6ft	80W	9200 LM	SMD 2835	1785x126x68mm	1810x390x170mm	5



ELECTRICAL COMPONENT

Osram, Philips, Tridonic or meanwell LED driver for 120V-277V/60Hz, 347V/60Hz, 240V/50Hz
 Ideal or WAGO UL/CUL approved quick disconnect VDE approved terminal block
 Everlight or Samsung LED Chips

SPECIFICATION

Die formed of 0.5mm cold-rolled steel body
 All steel surface are painted after fabrication with high gloss backed white coated powder
 High reflectance backed white acrylic paint finished
 High-diffusion light-milky PC diffuser

OPTION

Available for installing with dimmable & emergency kits
 Available for installing with sensor
 Available for hanging

APPLICATION

Shop / School / Office / Hotel / Conference Room / Hospital

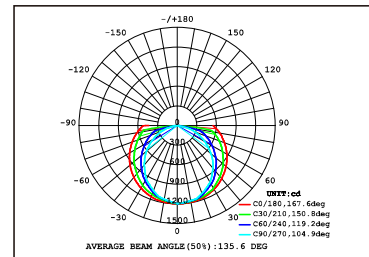
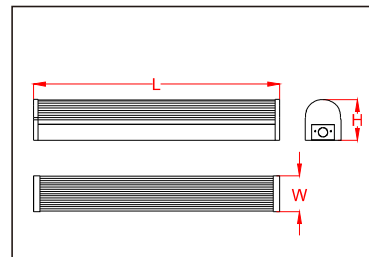

MODEL	WATTS	LUMEN	LED TYPE	LAMP SIZE (L X W X H)	PACKAGE SIZE	PCS/CTN
HG-L205-24W/2ft	24W/2ft	3120 LM	SMD 2835	616x82.5x93.5mm	655x205x225mm	4
HG-L205-36W/4ft	36W/4ft	4680 LM	SMD 2835	1206x82.5x93.5mm	1245x205x225mm	4
HG-L205-42W/8ft	42W/8ft	5460 LM	SMD 2835	2438x82.5x93.5mm	2480x205x225mm	4
HG-L205-68W/8ft	68W/8ft	8840 LM	SMD 2835	2438x82.5x93.5mm	2480x205x225mm	4



ELECTRICAL COMPONENT

Osram, Philips, Tridonic or meanwell LED driver for 120V-277V/60Hz, 347V/60Hz, 240V/50Hz
 Ideal or WAGO UL/CUL approved quick disconnect VDE approved terminal block
 Everlight or Samsung LED Chips

SPECIFICATION

Die formed of 0.5mm cold-rolled steel body
 All steel surface are painted after fabrication with high gloss backed white coated powder
 High reflectance backed white acrylic paint finished
 High-diffusion light-milky PC diffuser

OPTION

Available for installing with dimmable & emergency kits
 Available for installing with sensor
 Available for hanging

APPLICATION

Shop / School / Office / Hotel / Conference Room / Hospital

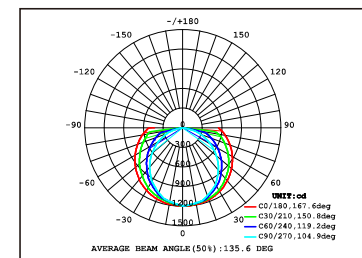
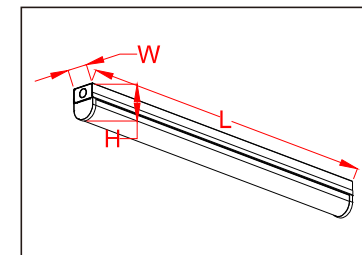

MODEL	WATTS	LUMEN	LED TYPE	LAMP SIZE (L X W X H)	PACKAGE SIZE	PCS/CTN
HG-L205B-252F	15/20/25W/2ft	3250LM	SMD 2835	605x60x82mm	635x290x150mm	6
HG-L205B-404F	20/25/40W/4ft	5200 LM	SMD 2835	1175x60x82mm	1205x290x150mm	6
HG-L205B-658F	55/60/65W/8ft	8450 LM	SMD 2835	2327x60x82mm	2355x290x150mm	6

LED LINEAR LIGHT

LED LINEAR LIGHT



ELECTRICAL COMPONENT

Osram, Philips, Tridonic or meanwell LED driver for 120V-277V/60Hz, 347V/60Hz, 240V/50Hz
 Ideal or WAGO UL/CUL approved quick disconnect VDE approved terminal block
 Everlight or Samsung LED Chips

SPECIFICATION

Die formed of 0.5mm cold-rolled steel body
 All steel surface are painted after fabrication with high gloss backed white coated powder
 High reflectance backed white acrylic paint finished
 High-diffusion light-milky PC diffuser

OPTION

Available for installing with dimmable & emergency kits
 Available for installing with sensor
 Available for hanging

APPLICATION

Shop / School / Office / Hotel / Conference Room / Hospital

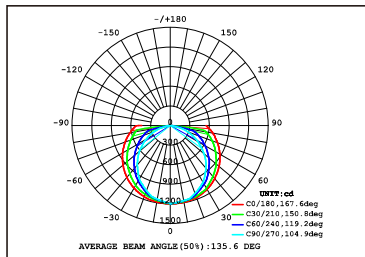
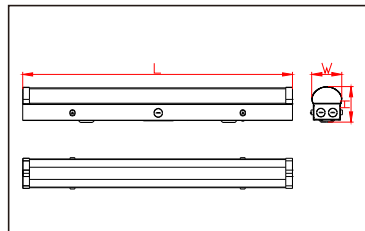

ELECTRICAL COMPONENT

Osram, Philips, Tridonic or meanwell LED driver for 120V-277V/60Hz, 347V/60Hz, 240V/50Hz
 Ideal or WAGO UL/CUL approved quick disconnect VDE approved terminal block
 Everlight or Samsung LED Chips

SPECIFICATION

Die formed of 0.5mm cold-rolled steel body
 All steel surface are painted after fabrication with high gloss backed white coated powder
 High reflectance backed white acrylic paint finished
 High-diffusion light-milky PC diffuser

OPTION

Available for installing with dimmable & emergency kits
 Available for installing with sensor
 Available for hanging

APPLICATION

Shop / School / Office / Hotel / Conference Room / Hospital

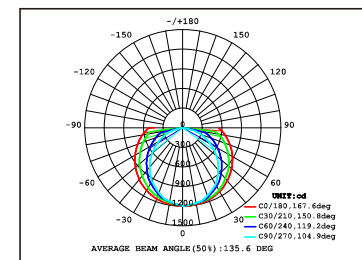
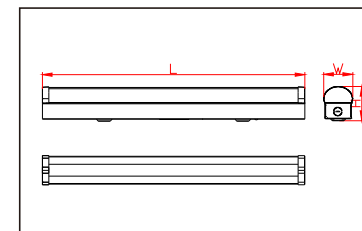

MODEL	WATTS	LUMEN	LED TYPE	LAMP SIZE (LxWxH)	PACKAGE SIZE	PCS/CTN
HG-L205C-252F	15/20/25W/2ft	3250LM	SMD 2835	609x75x83mm	645x275x220mm	6
HG-L205C-404F	25/30/40W/4ft	5200 LM	SMD 2835	1220x75x83mm	1255x275x220mm	6
HG-L205C-658F	55/60/65W/8ft	8450 LM	SMD 2835	2438x75x83mm	2475x190x220mm	4

MODEL	WATTS	LUMEN	LED TYPE	LAMP SIZE (LxWxH)	PACKAGE SIZE	PCS/CTN
HG-L205D-252F	15/20/25W/2ft	3250LM	SMD 2835	609x75x83mm	645x275x220mm	6
HG-L205D-404F	25/30/40W/4ft	5200 LM	SMD 2835	1220x75x83mm	1255x275x220mm	6
HG-L205D-658F	55/60/65W/8ft	8450 LM	SMD 2835	2438x75x83mm	2475x190x220mm	4

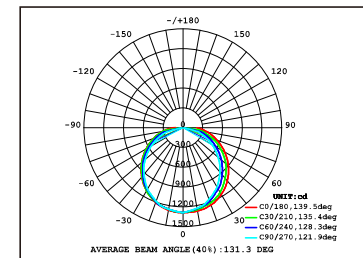
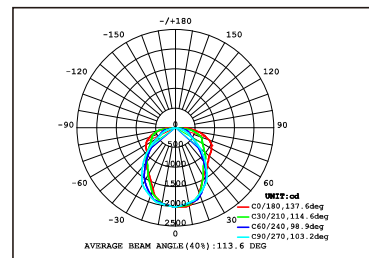
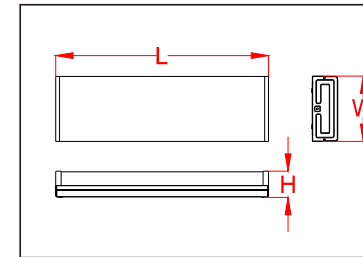
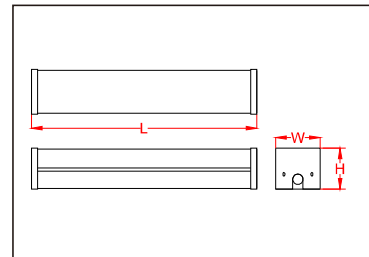

Osram, Philips, Tridonic or meanwell LED driver for 120V-277V/60Hz, 347V/60Hz, 240V/50Hz
 Ideal or WAGO UL/CUL approved quick disconnect VDE approved terminal block
 Everlight or Samsung LED Chips

Osram, Philips, Tridonic or meanwell LED driver for 120V-277V/60Hz, 347V/60Hz, 240V/50Hz
 Ideal or WAGO UL/CUL approved quick disconnect VDE approved terminal block
 Everlight or Samsung LED Chips

Housing: 0.5mm pressed & folded steel sheet with epoxy powder coated finish
 Diffuser: milk prismatic acrylic material
 LED Plate: 0.4mm pressed & folded steel sheet with epoxy powder coated finish

0.6mm pressed & folded steel sheet housing with epoxy powder coated finish
 High-diffusion Light milky PC diffuser

Available for installing with dimmable & emergency kits
 Available for installing with sensor
 Available for hanging

Available for installing with dimmable & emergency kits
 Available for installing with sensor
 Available for hanging

Shop / School / Office / Hotel / Conference Room / Hospital

Shop / School / Office / Hotel / Conference Room / Hospital

MODEL	WATTS	LUMEN	LED TYPE	LAMP SIZE (L X W X H)	PACKAGE SIZE	PCS/CTN
HG-L239-20W/2ft	20W	2300 LM	SMD 2835	602x105x96mm	640x365x240mm	6
HG-L239-25W/4ft	25W	2875LM	SMD 2835	1175x105x96mm	1210x365x240mm	6
HG-L239-36W/4ft	36W	4140 LM	SMD 2835	1175x105x96mm	1210x365x240mm	6
HG-L239-40W/4ft	40W	4600 LM	SMD 2835	1175x105x96mm	1210x365x240mm	6

MODEL	WATTS	LUMEN	LED TYPE	LAMP SIZE (L X W X H)	PACKAGE SIZE	PCS/CTN
HG-L202-25W/2ft	25W	2875M	SMD 2835	588x175x70mm	630x395x205mm	5
HG-L202-40W/4ft	40W	4600 LM	SMD 2835	1188x175x70mm	1230x395x205mm	5
HG-L202-50W/5ft	50W	5750 LM	SMD 2835	1488x175x70mm	1530x395x205mm	5
HG-L202-60W/6ft	60W	6900 LM	SMD 2835	1788x175x70mm	1830x395x205mm	5
HG-L202-80W/8ft	80W	9200 LM	SMD 2835	2344x175x70mm	2385x245x205mm	3

LED LINEAR LIGHT

LED LINEAR LIGHT

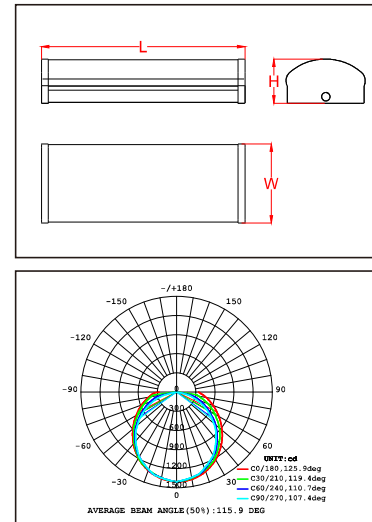

ELECTRICAL COMPONENT

Osram, Philips, Tridonic or meanwell LED driver for 120V-277V/60Hz, 347V/60Hz, 240V/50Hz
Ideal or WAGO UL/CUL approved quick disconnect VDE approved terminal block
Everlight or Samsung LED Chips

SPECIFICATION

0.6mm pressed & folded steel sheet housing with epoxy powder coated finish
High-diffusion Light milky PC diffuser

OPTION

Available for installing with dimmable & emergency kits
Available for installing with sensor
Available for hanging

APPLICATION

Shop / School / Office / Hotel / Conference Room / Hospital

MODEL	WATTS	LUMEN	LED TYPE	LAMP SIZE (L X W X H)	PACKAGE SIZE	PCS/CTN
HG-L203-20W/2ft	20W	2300 LM	SMD 2835	588x182x102mm	635x365x210mm	3
HG-L203-30W/4ft	30W	3450 LM	SMD 2835	1188x182x102mm	1235x365x210mm	3
HG-L203-40W/4ft	40W	4600 LM	SMD 2835	1188x182x102mm	1235x365x210mm	3
HG-L203-40W/5ft	40W	4600 LM	SMD 2835	1488x182x102mm	1535x365x210mm	3
HG-L203-60W/5ft	60W	6900 LM	SMD 2835	1488x182x102mm	1535x365x210mm	3
HG-L203-80W/6ft	80W	9200 LM	SMD 2835	1788x182x102mm	1835x365x210mm	3

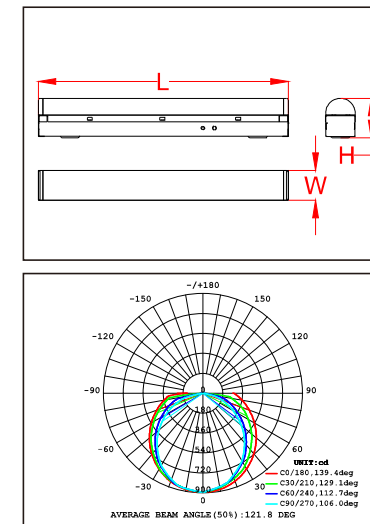

ELECTRICAL COMPONENT

Osram, Philips, Tridonic or meanwell LED driver for 120V-277V/60Hz, 347V/60Hz, 240V/50Hz
Ideal or WAGO UL/CUL approved quick disconnect VDE approved terminal block
Everlight or Samsung LED Chips

SPECIFICATION

Die formed of 0.5mm cold-rolled steel body
All steel surface are painted after fabrication with high gloss backed white coated powder
High reflectance backed white acrylic paint finished
High-diffusion light-milky PC diffuser

OPTION

Available for installing with dimmable & emergency kits
Available for installing with sensor
Available for hanging

APPLICATION

Shop / School / Office / Hotel / Conference Room / Hospital

MODEL	WATTS	LUMEN	LED TYPE	LAMP SIZE (L X W X H)	PACKAGE SIZE	PCS/CTN
HG-L207-24W/4ft	24W	2640 LM	SMD2835	1220x51.2x67.5mm	1265x195x175mm	6
HG-L207-32W/5ft	32W	3520 LM	SMD2835	1524x51.2x67.5mm	1570x195x175mm	6
HG-L207-60W/6ft	60W	6600 LM	SMD2835	1828x51.2x67.5mm	1875x195x175mm	6



LED TROFFER

LED TROFFER



ELECTRICAL COMPONENT
 Osram, Philips, Tridonic or meanwell LED driver for 120V-277V/60Hz, 347V/60Hz, 240V/50Hz
 Ideal or WAGO UL/CUL approved quick disconnect VDE approved terminal block
 Everlight or Samsung LED Chips

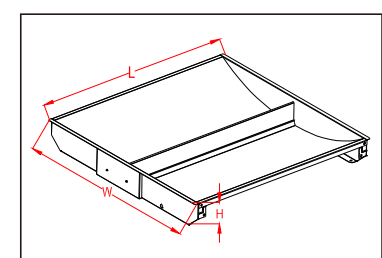

SPECIFICATION
 Die formed of 0.5mm cold-rolled steel body
 All steel surface are painted after fabrication with high gloss backed white matte powder
 High-diffusion light-milky PC diffuser
 Fully recessed luminaire fits standard T-Grid ceilings.

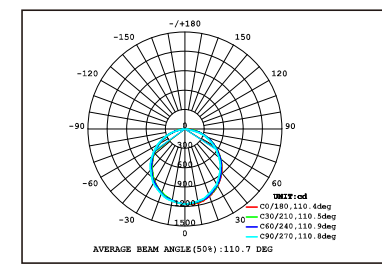

OPTION
 Available for dimmable version
 Available for emergency version
 Available for installing with sensor

APPLICATION
 Shop / School / Office / Hotel / Conference Room / Hospital

Halcon Lighting - LED TROFFER

The LED troffer delivers soft, glare-free, ambient lighting in a popular center-basket design. The slim profile of the fixture coupled with energy-saving LED technology make the Troffer an ideal choice for renovation or new construction. The LED troffer offers a high-quality, cost-effective LED lighting solution for schools, offices, retail, healthcare facilities and other commercial spaces.

MODEL	WATTS	LUMEN	LED TYPE	LAMP SIZE (L X W X H)	PACKAGE SIZE	PCS/CTN
E1907-22-30W	30W	3450 LM	SMD 2835	603x603x80mm	645x105x650mm	1
E1907-22-36W	36W	4140 LM	SMD 2835	603x603x80mm	645x105x650mm	1
E1907-24-50W	50W	5750 LM	SMD 2835	1213x603x80mm	1250x105x650mm	1

LED TROFFER

LED TROFFER

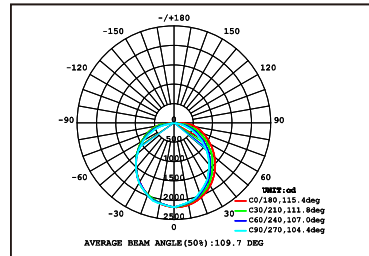
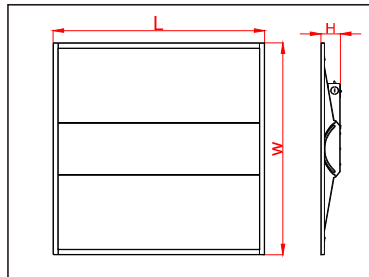

ELECTRICAL COMPONENT

Osram, Philips, Tridonic or meanwell LED driver for 120V-277V/60Hz, 347V/60Hz, 240V/50Hz
 Ideal or WAGO UL/CUL approved quick disconnect VDE approved terminal block
 Everlight or Samsung LED Chips

SPECIFICATION

Die formed of 0.5mm cold-rolled steel body
 All steel surface are painted after fabrication with high gloss backed white matte powder
 High-diffusion light-milky PC diffuser
 Fully recessed luminaire fits standard T-Grid ceilings.

OPTION

Available for dimmable version
 Available for emergency version
 Available for installing with sensor

APPLICATION

Shop / School / Office / Hotel / Conference Room / Hospital

MODEL	WATTS	LUMEN	LED TYPE	LAMP SIZE (L X W X H)	PACKAGE SIZE	PCS/CTN
HG-L249C-24-24W	24W	3000 LM	SMD 2835	1213x603x55mm	645x125x1250mm	2
HG-L249C-24-36W	36W	4500 LM	SMD 2835	1213x603x55mm	645x125x1250mm	2
HG-L249C-24-42W	42W	5250 LM	SMD 2835	1213x603x55mm	645x125x1250mm	2
HG-L249C-24-50W	50W	6250 LM	SMD 2835	1213x603x55mm	645x125x1250mm	2
HG-L249-24/24W/36W/42W/50W	24W/36W/42W/50W	6250 LM	SMD 2835	1213x603x55mm	645x125x1250mm	2

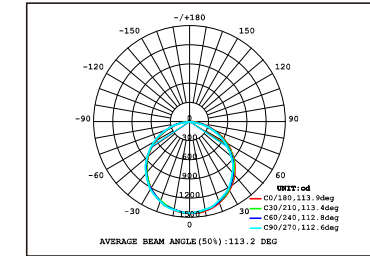
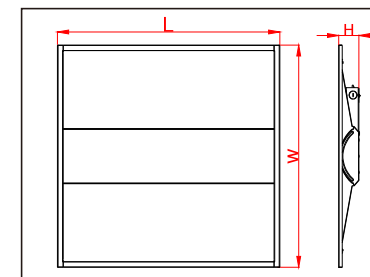

ELECTRICAL COMPONENT

Osram, Philips, Tridonic or meanwell LED driver for 120V-277V/60Hz, 347V/60Hz, 240V/50Hz
 Ideal or WAGO UL/CUL approved quick disconnect VDE approved terminal block
 Everlight or Samsung LED Chips

SPECIFICATION

Die formed of 0.5mm cold-rolled steel body
 All steel surface are painted after fabrication with high gloss backed white matte powder
 High-diffusion light-milky PC diffuser
 Fully recessed luminaire fits standard T-Grid ceilings.

OPTION

Available for dimmable version
 Available for emergency version
 Available for installing with sensor

APPLICATION

Shop / School / Office / Hotel / Conference Room / Hospital

MODEL	WATTS	LUMEN	LED TYPE	LAMP SIZE (L X W X H)	PACKAGE SIZE	PCS/CTN
HG-L249C-22/20W	20W	2500 LM	SMD 2835	603x603x55mm	645x125x650mm	2
HG-L249C-22/24W	24W	3000 LM	SMD 2835	603x603x55mm	645x125x650mm	2
HG-L249C-22/36W	36W	4500 LM	SMD 2835	603x603x55mm	645x125x650mm	2
HG-L249-22/20W/24W/36W	20W/24W/36W	4500 LM	SMD 2835	603x603x55mm	645x125x650mm	2

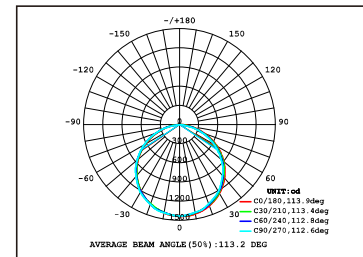
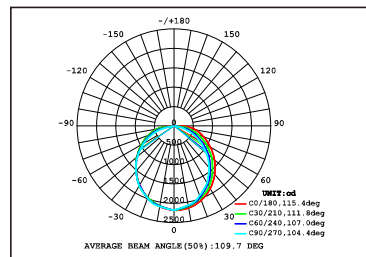
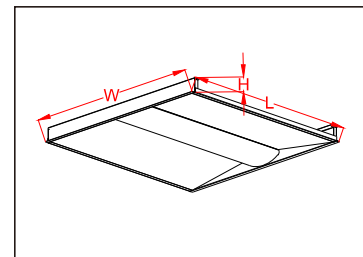
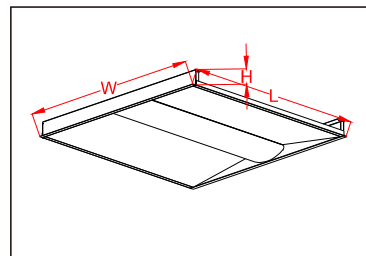

ELECTRICAL COMPONENT

Osram, Philips, Tridonic or meanwell LED driver for 120V-277V/60Hz, 347V/60Hz, 240V/50Hz
 Ideal or WAGO UL/CUL approved quick disconnect VDE approved terminal block
 Everlight or Samsung LED Chips

SPECIFICATION

Die formed of 0.5mm cold-rolled steel body
 All steel surface are painted after fabrication with high gloss backed white matte powder
 High-diffusion light-milky PC diffuser
 Fully recessed luminaire fits standard T-Grid ceilings.

OPTION

Available for dimmable version
 Available for emergency version
 Available for installing with sensor

APPLICATION

Shop / School / Office / Hotel / Conference Room / Hospital

ELECTRICAL COMPONENT

Osram, Philips, Tridonic or meanwell LED driver for 120V-277V/60Hz, 347V/60Hz, 240V/50Hz
 Ideal or WAGO UL/CUL approved quick disconnect VDE approved terminal block
 Everlight or Samsung LED Chips

SPECIFICATION

Die formed of 0.5mm cold-rolled steel body
 All steel surface are painted after fabrication with high gloss backed white matte powder
 High-diffusion light-milky PC diffuser
 Fully recessed luminaire fits standard T-Grid ceilings.

OPTION

Available for dimmable version
 Available for emergency version
 Available for installing with sensor

APPLICATION

Shop / School / Office / Hotel / Conference Room / Hospital

MODEL	WATTS	LUMEN	LED TYPE	LAMP SIZE (L X W X H)	PACKAGE SIZE	PCS/CTN
HG-L249B-24-30W	30W	3750 LM	SMD 2835	1213x603x45mm	645x105x1250mm	2
HG-L249B-24-40W	40W	5000 LM	SMD 2835	1213x603x45mm	645x105x1250mm	2
HG-L249B-24-50W	50W	6250 LM	SMD 2835	1213x603x45mm	645x105x1250mm	2

MODEL	WATTS	LUMEN	LED TYPE	LAMP SIZE (L X W X H)	PACKAGE SIZE	PCS/CTN
HG-L249B-22-20W	20W	2500 LM	SMD 2835	603x603x45mm	645x105x650mm	2
HG-L249B-22-30W	30W	3750 LM	SMD 2835	603x603x45mm	645x105x650mm	2
HG-L249B-22-40W	40W	5000 LM	SMD 2835	603x603x43mm	645x105x650mm	2

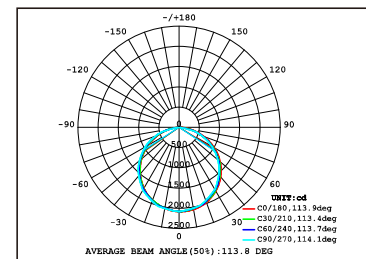
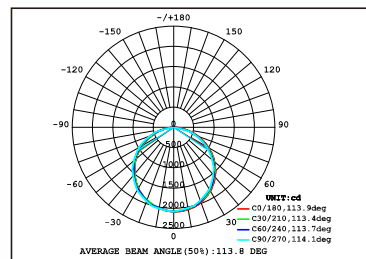
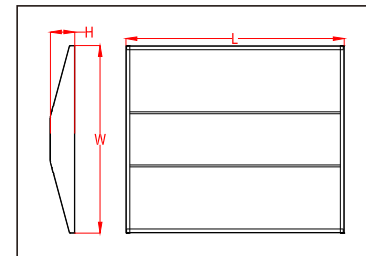
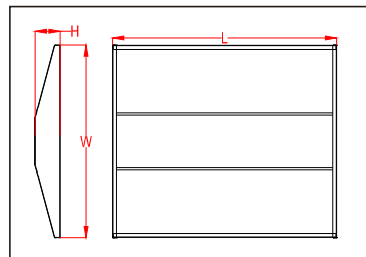

ELECTRICAL COMPONENT

Osram, Philips, Tridonic or meanwell LED driver for 120V-277V/60Hz, 347V/60Hz, 240V/50Hz
 Ideal or WAGO UL/CUL approved quick disconnect VDE approved terminal block
 Everlight or Samsung LED Chips

SPECIFICATION

Die formed of 0.6mm cold-rolled steel body
 All steel surface are painted after fabrication with high gloss backed white matte powder
 High-diffusion light-milky PC diffuser
 Fully recessed luminaire fits standard T-Grid ceilings.

OPTION

Available for dimmable version
 Available for emergency version
 Available for installing with sensor

APPLICATION

Shop / School / Office / Hotel / Conference Room / Hospital

ELECTRICAL COMPONENT

Osram, Philips, Tridonic or meanwell LED driver for 120V-277V/60Hz, 347V/60Hz, 240V/50Hz
 Ideal or WAGO UL/CUL approved quick disconnect VDE approved terminal block
 Everlight or Samsung LED Chips

SPECIFICATION

Die formed of 0.6mm cold-rolled steel body
 All steel surface are painted after fabrication with high gloss backed white matte powder
 High-diffusion light-milky PC diffuser
 Fully recessed luminaire fits standard T-Grid ceilings.

OPTION

Available for dimmable version
 Available for emergency version
 Available for installing with sensor

APPLICATION

Shop / School / Office / Hotel / Conference Room / Hospital

MODEL	WATTS	LUMEN	LED TYPE	LAMP SIZE (L X W X H)	PACKAGE SIZE	PCS/CTN
HG-L254-24-40W	40W	5000 LM	SMD 2835	1210x605x80mm	640x100x1250mm	1
HG-L254-24-50W	50W	6250 LM	SMD 2835	1210x605x80mm	640x100x1250mm	1

MODEL	WATTS	LUMEN	LED TYPE	LAMP SIZE (L X W X H)	PACKAGE SIZE	PCS/CTN
HG-L254-22-27W	27W	3375 LM	SMD 2835	605x605x80mm	640x100x640mm	1
HG-L254-22-36W	36W	4500 LM	SMD 2835	605x605x80mm	640x100x640mm	1

LED TROFFER

LED RETROFIT KIT TROFFER



ELECTRICAL COMPONENT

Osram, Philips, Tridonic or meanwell LED driver for 120V-277V/60Hz, 347V/60Hz, 240V/50Hz
Ideal or WAGO UL/CUL approved quick disconnect VDE approved terminal block
Everlight or Samsung LED Chips

SPECIFICATION

Die formed of 0.6mm cold-rolled steel body
All steel surface are painted after fabrication with high gloss backed white matte powder
High-diffusion light-milky PC diffuser
Fully recessed luminaire fits standard T-Grid ceilings.

OPTION

Available for dimmable version
Available for emergency version
Available for installing with sensor

APPLICATION

Shop / School / Office / Hotel / Conference Room / Hospital

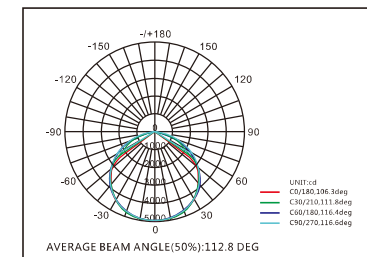
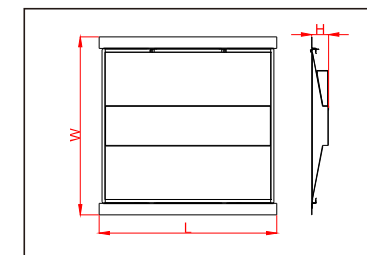
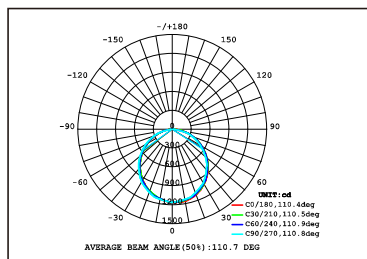
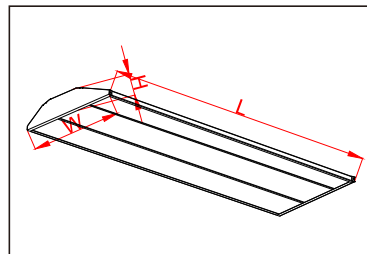

ELECTRICAL COMPONENT

Osram, Philips, Tridonic or meanwell LED driver for 120V-277V/60Hz, 347V/60Hz, 240V/50Hz
Ideal or WAGO UL/CUL approved quick disconnect VDE approved terminal block
Everlight or Samsung LED Chips

SPECIFICATION

Die formed of 0.6mm cold-rolled steel body
All steel surface are painted after fabrication with high gloss backed white matte powder
High-diffusion light-milky PC diffuser
Fully recessed luminaire fits standard T-Grid ceilings.

OPTION

Available for dimmable version
Available for emergency version
Available for installing with sensor

APPLICATION

Shop / School / Office / Hotel / Conference Room / Hospital

MODEL	WATTS	LUMEN	LED TYPE	LAMP SIZE (L X W X H)	PACKAGE SIZE	PCS/CTN
HG-L254-14-30W	30W	3750 LM	SMD 2835	1210x305x80mm	340x100x1250mm	1
HG-L254-14-40W	40W	5000 LM	SMD 2835	1210x305x80mm	340x100x1250mm	1

MODEL	WATTS	LUMEN	LED TYPE	LAMP SIZE (L X W X H)	PACKAGE SIZE	PCS/CTN
HG-L249R-22-30W	30W	3750 LM	SMD 2835	610x610x57.5mm	640x155x590mm	2
HG-L249R-22-40W	40W	5000 LM	SMD 2835	610x610x57.5mm	640x155x590mm	2
HG-L249R-24-40W	40W	5000 LM	SMD 2835	1210x610x57.5mm	1250x155x590mm	2
HG-L249R-24-50W	50W	6250 LM	SMD 2835	1210x610x57.5mm	1250x155x590mm	2

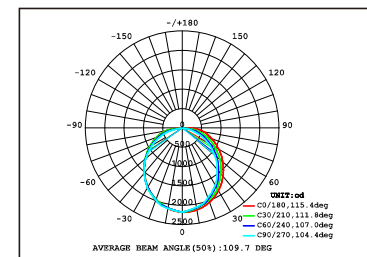
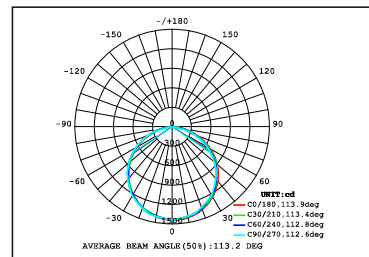
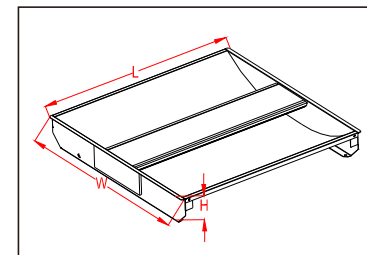
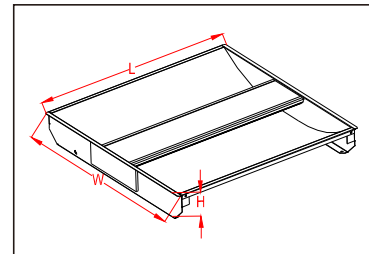

ELECTRICAL COMPONENT

Osram, Philips, Tridonic or meanwell LED driver for 120V-277V/60Hz, 347V/60Hz, 240V/50Hz
 Ideal or WAGO UL/CUL approved quick disconnect VDE approved terminal block
 Everlight or Samsung LED Chips

SPECIFICATION

Die formed of 0.5mm cold-rolled steel body
 All steel surface are painted after fabrication with high gloss backed white matte powder
 High-diffusion light-milky PC diffuser
 Fully recessed luminaire fits standard T-Grid ceilings.

OPTION

Available for dimmable version
 Available for emergency version
 Available for installing with sensor

APPLICATION

Shop / School / Office / Hotel / Conference Room / Hospital

ELECTRICAL COMPONENT

Osram, Philips, Tridonic or meanwell LED driver for 120V-277V/60Hz, 347V/60Hz, 240V/50Hz
 Ideal or WAGO UL/CUL approved quick disconnect VDE approved terminal block
 Everlight or Samsung LED Chips

SPECIFICATION

Die formed of 0.5mm cold-rolled steel body
 All steel surface are painted after fabrication with high gloss backed white matte powder
 High-diffusion light-milky PC diffuser
 Fully recessed luminaire fits standard T-Grid ceilings.

OPTION

Available for dimmable version
 Available for emergency version
 Available for installing with sensor

APPLICATION

Shop / School / Office / Hotel / Conference Room / Hospital

MODEL	WATTS	LUMEN	LED TYPE	LAMP SIZE (L X W X H)	PACKAGE SIZE	PCS/CTN
E1903-24-40W	40W	4600 LM	SMD 4014	1213x603x75mm	1250x100x650mm	1
E1903-24-50W	50W	5750 LM	SMD 4014	1213x603x75mm	1250x100x650mm	1

MODEL	WATTS	LUMEN	LED TYPE	LAMP SIZE (L X W X H)	PACKAGE SIZE	PCS/CTN
E1903-22-30W	30W	3450 LM	SMD 4014	603x603x75mm	645x100x650mm	1
E1903-22-40W	40W	4600 LM	SMD 4014	603x603x75mm	645x100x650mm	1

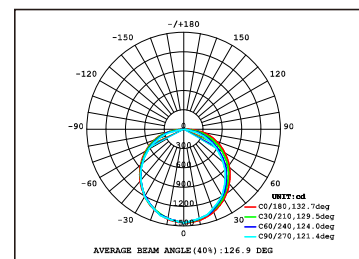
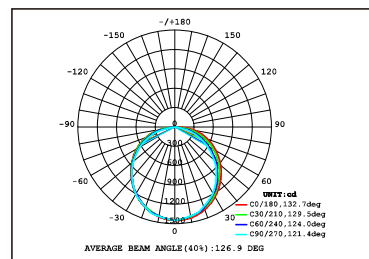
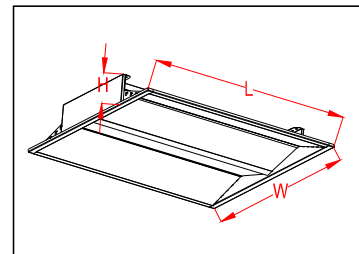
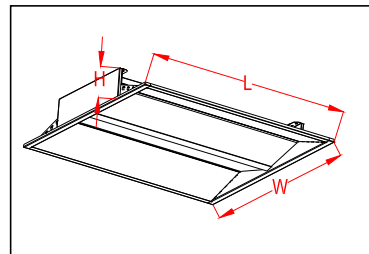

ELECTRICAL COMPONENT

Osram, Philips, Tridonic or meanwell LED driver for 120V-277V/60Hz, 347V/60Hz, 240V/50Hz
 Ideal or WAGO UL/CUL approved quick disconnect VDE approved terminal block
 Everlight or Samsung LED Chips

SPECIFICATION

Die formed of 0.6mm cold-rolled steel body
 All steel surface with high gloss backed white matte powder
 High reflectance backed white acrylic paint finished
 High-diffusion light-milky PC diffuser
 Fully recessed luminaire fits standard T-Grid ceilings.

OPTION

Available for dimmable version
 Available for emergency version
 Available for installing with sensor

APPLICATION

Shop / School / Office / Hotel / Conference Room / Hospital

ELECTRICAL COMPONENT

Osram, Philips, Tridonic or meanwell LED driver for 120V-277V/60Hz, 347V/60Hz, 240V/50Hz
 Ideal or WAGO UL/CUL approved quick disconnect VDE approved terminal block
 Everlight or Samsung LED Chips

SPECIFICATION

Die formed of 0.6mm cold-rolled steel body
 All steel surface with high gloss backed white matte powder
 High reflectance backed white acrylic paint finished
 High-diffusion light-milky PC diffuser
 Fully recessed luminaire fits standard T-Grid ceilings.

OPTION

Available for dimmable version
 Available for emergency version
 Available for installing with sensor

APPLICATION

Shop / School / Office / Hotel / Conference Room / Hospital

MODEL	WATTS	LUMEN	LED TYPE	LAMP SIZE (L X W X H)	PACKAGE SIZE	PCS/CTN
HG-L208T-40W/2'x4'	40W	4600 LM	SMD 2835	1210x605x90mm	640x110x1250mm	1
HG-L208T-50W/2'x4'	50W	5750 LM	SMD 2835	1210x605x90mm	640x110x1250mm	1

MODEL	WATTS	LUMEN	LED TYPE	LAMP SIZE (L X W X H)	PACKAGE SIZE	PCS/CTN
HG-L208T-24W/2'x2'	24W	2760 LM	SMD 2835	605x605x90mm	640x110x645mm	1
HG-L208T-36W/2'x2'	36W	4140 LM	SMD 2835	605x605x90mm	640x110x645mm	1

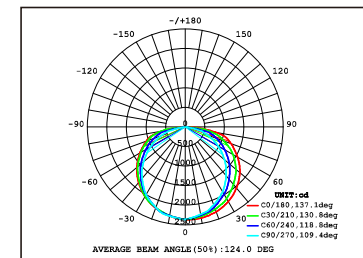
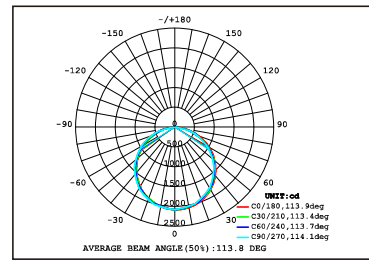
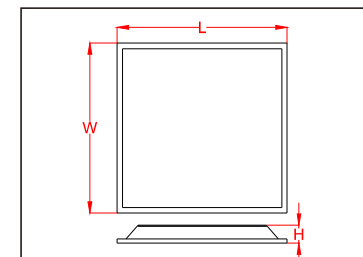
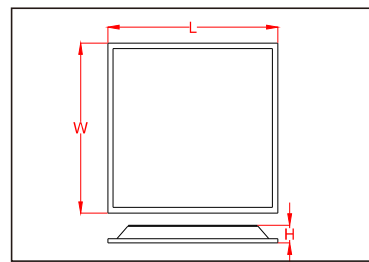

ELECTRICAL COMPONENT

Osram, Philips, Tridonic or meanwell LED driver for 120V-277V/60Hz, 347V/60Hz, 240V/50Hz
 Ideal or WAGO UL/CUL approved quick disconnect VDE approved terminal block
 Everlight or Samsung LED Chips

SPECIFICATION

Die formed of 0.6mm cold-rolled steel body
 All steel surface with high gloss backed white matte powder
 High reflectance backed white acrylic paint finished
 High-diffusion light-milky PC diffuser
 Fully recessed luminaire fits standard T-Grid ceilings.

OPTION

Available for dimmable version
 Available for emergency version
 Available for installing with sensor

APPLICATION

Shop / School / Office / Hotel / Conference Room / Hospital

ELECTRICAL COMPONENT

Osram, Philips, Tridonic or meanwell LED driver for 120V-277V/60Hz, 347V/60Hz, 240V/50Hz
 Ideal or WAGO UL/CUL approved quick disconnect VDE approved terminal block
 Everlight or Samsung LED Chips

SPECIFICATION

Aluminum Frame with white powder coated
 High reflectance backed white acrylic paint finished
 High-diffusion light-milky PC diffuser
 Fully recessed luminaire fits standard T-Grid ceilings.

OPTION

Available for dimmable version
 Available for emergency version
 Available for installing with sensor

APPLICATION

Shop / School / Office / Hotel / Conference Room / Hospital

MODEL	WATTS	LUMEN	LED TYPE	LAMP SIZE (L X W X H)	PACKAGE SIZE	PCS/CTN
E2010-14-30W	30W	3450 LM	SMD 2835	1213x303x40mm	340x90x645mm	2
E2010-14-50W	50W	5750LM	SMD 2835	1213x303x40mm	340x90x645mm	2
E2010-24-40W	40W	4600 LM	SMD 2835	1213x603x40mm	640x90x1245mm	2
E2010-24-50W	50W	5750 LM	SMD 2835	1213x603x40mm	640x90x1245mm	2
E2010-24-68W	68W	7820 LM	SMD 2835	1213x603x40mm	640x90x1245mm	2

MODEL	WATTS	LUMEN	LED TYPE	LAMP SIZE (L X W X H)	PACKAGE SIZE	PCS/CTN
E2010-22-24W	24W	2760 LM	SMD 2835	603x603x40mm	640x90x645mm	2
E2010-22-36W	36W	4140 LM	SMD 2835	603x603x40mm	640x90x645mm	2



LED TROFFER

LED TROFFER

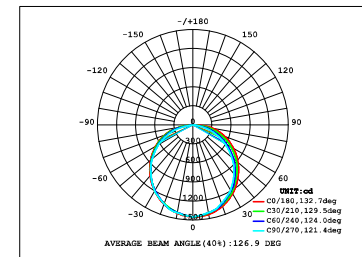
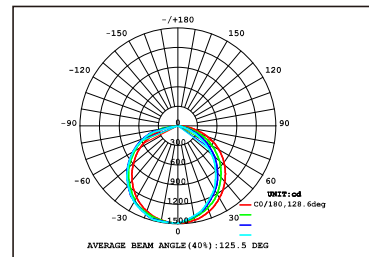
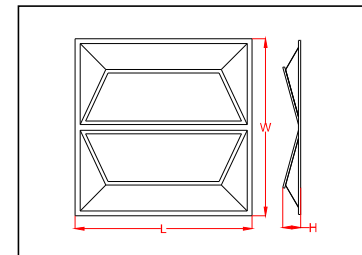
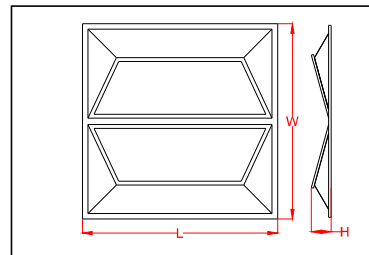

ELECTRICAL COMPONENT

Osram, Philips, Tridonic or meanwell LED driver for 120V-277V/60Hz, 347V/60Hz, 240V/50Hz
Ideal or WAGO UL/CUL approved quick disconnect VDE approved terminal block
Everlight or Samsung LED Chips

SPECIFICATION

Die formed of 0.6mm cold-rolled steel body
All steel surface with high gloss backed white matte powder
High reflectance backed white acrylic paint finished
High-diffusion light-milky PC diffuser
Fully recessed luminaire fits standard T-Grid ceilings.

OPTION

Available for dimmable version
Available for emergency version
Available for installing with sensor

APPLICATION

Shop / School / Office / Hotel / Conference Room / Hospital

ELECTRICAL COMPONENT

Osram, Philips, Tridonic or meanwell LED driver for 120V-277V/60Hz, 347V/60Hz, 240V/50Hz
Ideal or WAGO UL/CUL approved quick disconnect VDE approved terminal block
Everlight or Samsung LED Chips

SPECIFICATION

Die formed of 0.6mm cold-rolled steel body
All steel surface with high gloss backed white matte powder
High reflectance backed white acrylic paint finished
High-diffusion light-milky PC diffuser
Fully recessed luminaire fits standard T-Grid ceilings.

OPTION

Available for dimmable version
Available for emergency version
Available for installing with sensor

APPLICATION

Shop / School / Office / Hotel / Conference Room / Hospital

MODEL	WATTS	LUMEN	LED TYPE	LAMP SIZE (L X W X H)	PACKAGE SIZE	PCS/CTN
E1805-22-30W	30W	3450 LM	SMD 2835	605x605x65mm	640x155x645mm	2
E1805-22-36W	36W	4140 LM	SMD 2835	605x605x65mm	640x155x645mm	2

MODEL	WATTS	LUMEN	LED TYPE	LAMP SIZE (L X W X H)	PACKAGE SIZE	PCS/CTN
E1805-24-40W	40W	4600 LM	SMD 2835	1210x605x65mm	1250x155x645mm	2
E1805-24-55W	55W	6325 LM	SMD 2835	1210x605x65mm	1250x155x645mm	2

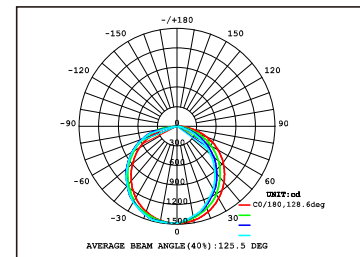
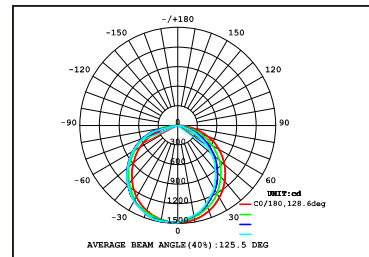
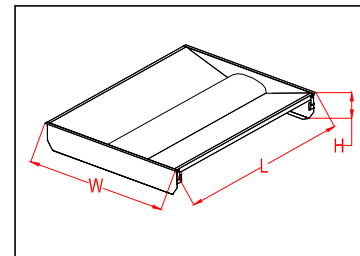
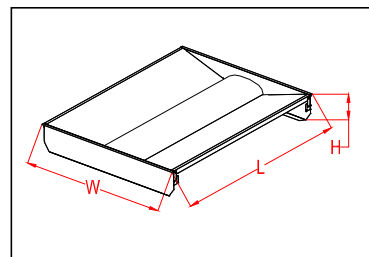

ELECTRICAL COMPONENT

Osram, Philips, Tridonic or meanwell LED driver for 120V-277V/60Hz, 347V/60Hz, 240V/50Hz
 Ideal or WAGO UL/CUL approved quick disconnect VDE approved terminal block
 Everlight or Samsung LED Chips

SPECIFICATION

Die formed of 0.6mm cold-rolled steel body
 All steel surface with high gloss backed white matte powder
 High reflectance backed white acrylic paint finished
 High-diffusion light-milky PC diffuser
 Fully recessed luminaire fits standard T-Grid ceilings.

OPTION

Available for dimmable version
 Available for emergency version
 Available for installing with sensor

APPLICATION

Shop / School / Office / Hotel / Conference Room / Hospital

ELECTRICAL COMPONENT

Osram, Philips, Tridonic or meanwell LED driver for 120V-277V/60Hz, 347V/60Hz, 240V/50Hz
 Ideal or WAGO UL/CUL approved quick disconnect VDE approved terminal block
 Everlight or Samsung LED Chips

SPECIFICATION

Die formed of 0.6mm cold-rolled steel body
 All steel surface with high gloss backed white matte powder
 High reflectance backed white acrylic paint finished
 High-diffusion light-milky PC diffuser
 Fully recessed luminaire fits standard T-Grid ceilings.

OPTION

Available for dimmable version
 Available for emergency version
 Available for installing with sensor

APPLICATION

Shop / School / Office / Hotel / Conference Room / Hospital

MODEL	WATTS	LUMEN	LED TYPE	LAMP SIZE (L X W X H)	PACKAGE SIZE	PCS/CTN
HG-L249-42W/2'x4'	42W	4830 LM	SMD 2835	1210x605x106.5mm	640x130x1250mm	1
HG-L249-50W/2'x4'	50W	5750 LM	SMD 2835	1210x605x106.5mm	640x130x1250mm	1
HG-L249-68W/2'x4'	68W	7820 LM	SMD 2835	1210x605x106.5mm	640x130x1250mm	1

MODEL	WATTS	LUMEN	LED TYPE	LAMP SIZE (L X W X H)	PACKAGE SIZE	PCS/CTN
HG-L249-24W/2'x2'	24W	2760 LM	SMD 2835	605x605x106.5mm	640x130x640mm	1
HG-L249-36W/2'x2'	36W	4140 LM	SMD 2835	605x605x106.5mm	640x130x640mm	1
HG-L249-36W/1'x4'	36W	4140 LM	SMD 2835	1210x305x106.5mm	340x130x1250mm	1

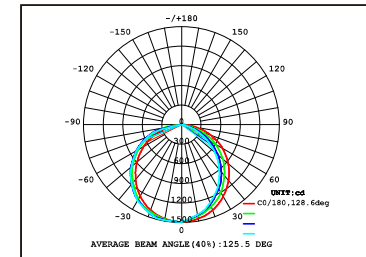
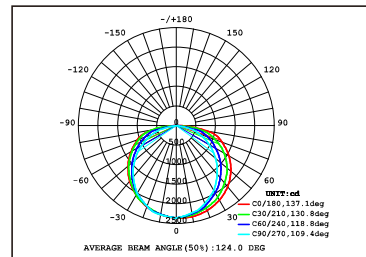
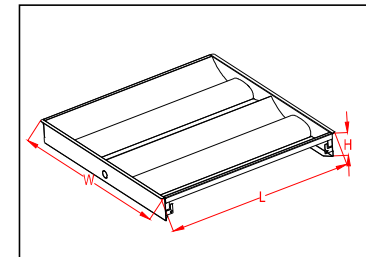
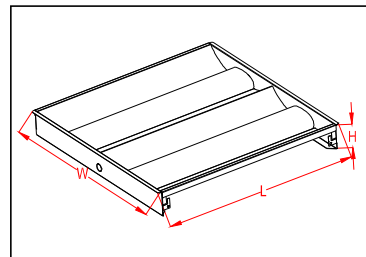

ELECTRICAL COMPONENT

Osram, Philips, Tridonic or meanwell LED driver for 120V-277V/60Hz, 347V/60Hz, 240V/50Hz
 Ideal or WAGO UL/CUL approved quick disconnect VDE approved terminal block
 Everlight or Samsung LED Chips

SPECIFICATION

Die formed of 0.6mm cold-rolled steel body
 All steel surface with high gloss backed white matte powder
 High reflectance backed white acrylic paint finished
 High-diffusion light-milky PC diffuser
 Fully recessed luminaire fits standard T-Grid ceilings.

OPTION

Available for dimmable version
 Available for emergency version
 Available for installing with sensor

APPLICATION

Shop / School / Office / Hotel / Conference Room / Hospital

ELECTRICAL COMPONENT

Osram, Philips, Tridonic or meanwell LED driver for 120V-277V/60Hz, 347V/60Hz, 240V/50Hz
 Ideal or WAGO UL/CUL approved quick disconnect VDE approved terminal block
 Everlight or Samsung LED Chips

SPECIFICATION

Die formed of 0.6mm cold-rolled steel body
 All steel surface with high gloss backed white matte powder
 High reflectance backed white acrylic paint finished
 High-diffusion light-milky PC diffuser
 Fully recessed luminaire fits standard T-Grid ceilings.

OPTION

Available for dimmable version
 Available for emergency version
 Available for installing with sensor

APPLICATION

Shop / School / Office / Hotel / Conference Room / Hospital

MODEL	WATTS	LUMEN	LED TYPE	LAMP SIZE (L X W X H)	PACKAGE SIZE	PCS/CTN
HG-L248-42W/2'x4'	42W	4830 LM	SMD 2835	1210x605x75mm	650x100x1225mm	1
HG-L248-50W/2'x4'	50W	5750 LM	SMD 2835	1210x605x75mm	640x100x1225mm	1
HG-L248-68W/2'x4'	68W	7820 LM	SMD 2835	1210x605x75mm	640x100x1225mm	1

MODEL	WATTS	LUMEN	LED TYPE	LAMP SIZE (L X W X H)	PACKAGE SIZE	PCS/CTN
HG-L248-24W/2'x2'	24W	2760 LM	SMD 2835	605x605x75mm	650x100x650mm	1
HG-L248-36W/2'x2'	36W	4140 LM	SMD 2835	605x605x75mm	650x100x650mm	1



ELECTRICAL COMPONENT

Osram, Philips, Tridonic or meanwell LED driver for 120V-277V/60Hz, 347V/60Hz, 240V/50Hz
 Ideal or WAGO UL/CUL approved quick disconnect VDE approved terminal block
 Everlight or Samsung LED Chips

SPECIFICATION

Die formed of 0.6mm cold-rolled steel body
 All steel surface with high gloss backed white matte powder
 High reflectance backed white acrylic paint finished
 High-diffusion prismatic acrylic diffuser
 Fully recessed luminaire fits standard T-Grid ceilings.

OPTION

Available for dimmable version
 Available for emergency version
 Available for installing with sensor

APPLICATION

Shop / School / Office / Hotel / Conference Room / Hospital

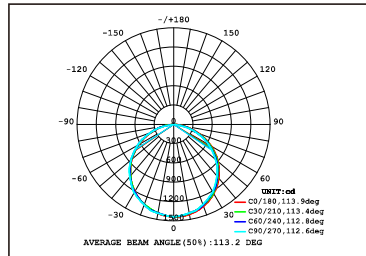
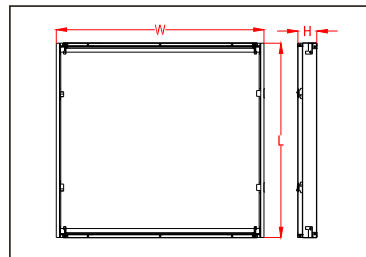

ELECTRICAL COMPONENT

Osram, Philips, Tridonic or meanwell LED driver for 120V-277V/60Hz, 347V/60Hz, 240V/50Hz
 Ideal or WAGO UL/CUL approved quick disconnect VDE approved terminal block
 Everlight or Samsung LED Chips

SPECIFICATION

Die formed of 0.6mm cold-rolled steel body
 All steel surface with high gloss backed white matte powder
 High reflectance backed white acrylic paint finished
 High-diffusion prismatic acrylic diffuser
 Fully recessed luminaire fits standard T-Grid ceilings.

OPTION

Available for dimmable version
 Available for emergency version
 Available for installing with sensor

APPLICATION

Shop / School / Office / Hotel / Conference Room / Hospital

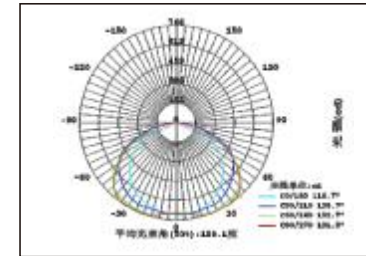
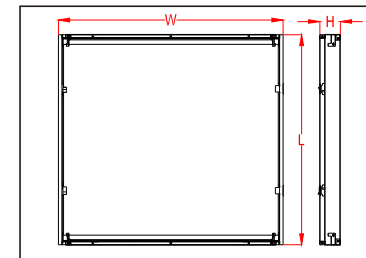

MODEL	WATTS	LUMEN	LED TYPE	LAMP SIZE (L X W X H)	PACKAGE SIZE	PCS/CTN
HG-L229-24W/2'x2'	24W	2760 LM	SMD 2835	605x605x55.5mm	640x85x650mm	1
HG-L229-40W/2'x2'	40W	4600 LM	SMD 2835	605x605x55.5mm	640x85x650mm	1

MODEL	WATTS	LUMEN	LED TYPE	LAMP SIZE (L X W X H)	PACKAGE SIZE	PCS/CTN
HG-L229-24W/1'x4'	24W	2760 LM	SMD 2835	1210x305x55.5mm	340x85x1250mm	1
HG-L229-40W/1'x4'	40W	4600 LM	SMD 2835	1210x305x55.5mm	340x85x1250mm	1
HG-L229-45W/2'x4'	45W	5175 LM	SMD 2835	1210x605x55.5mm	640x85x1250mm	1
HG-L229-40W/2'x4'	40W	4600 LM	SMD 2835	1210x605x55.5mm	640x85x1250mm	1

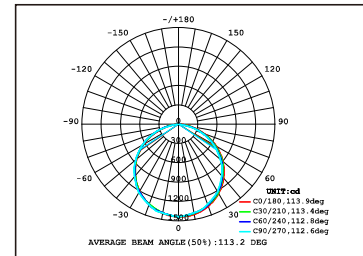
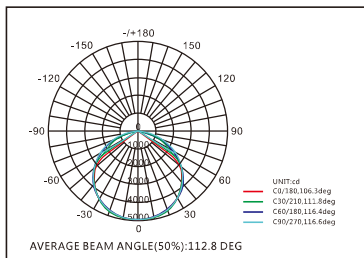
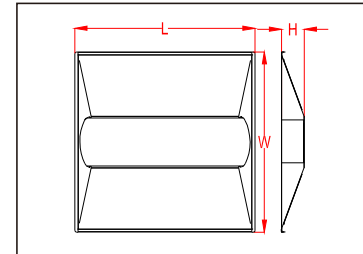
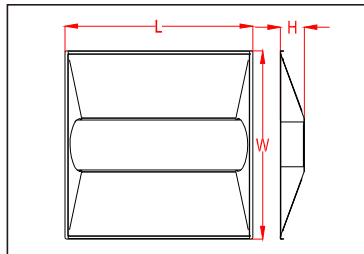

ELECTRICAL COMPONENT

Osram, Philips, Tridonic or meanwell LED driver for 120V-277V/60Hz, 347V/60Hz, 240V/50Hz
 Ideal or WAGO UL/CUL approved quick disconnect VDE approved terminal block
 Everlight or Samsung LED Chips

SPECIFICATION

Die formed of 0.6mm cold-rolled steel body
 All steel surface are painted after fabrication with high gloss backed white matte powder
 High-diffusion light-milky PC diffuser
 Fully recessed luminaire fits standard T-Grid ceilings.

OPTION

Available for dimmable version
 Available for emergency version
 Available for installing with sensor

APPLICATION

Shop / School / Office / Hotel / Conference Room / Hospital

ELECTRICAL COMPONENT

Osram, Philips, Tridonic or meanwell LED driver for 120V-277V/60Hz, 347V/60Hz, 240V/50Hz
 Ideal or WAGO UL/CUL approved quick disconnect VDE approved terminal block
 Everlight or Samsung LED Chips

SPECIFICATION

Die formed of 0.6mm cold-rolled steel body
 All steel surface are painted after fabrication with high gloss backed white matte powder
 High-diffusion light-milky PC diffuser
 Fully recessed luminaire fits standard T-Grid ceilings.

OPTION

Available for dimmable version
 Available for emergency version
 Available for installing with sensor

APPLICATION

Shop / School / Office / Hotel / Conference Room / Hospital

MODEL	WATTS	LUMEN	LED TYPE	LAMP SIZE (L X W X H)	PACKAGE SIZE	PCS/CTN
HG-L249E-40W/1'x4'	40W	4600 LM	SMD 2835	1210x305x76mm	340x100x1250mm	1
HG-L249E-40W/2'x4'	40W	4600 LM	SMD 2835	1210x605x76mm	640x100x1250mm	1
HG-L249E-45W/2'x4'	45W	5175 LM	SMD 2835	1210x605x76mm	640x100x1250mm	1

MODEL	WATTS	LUMEN	LED TYPE	LAMP SIZE (L X W X H)	PACKAGE SIZE	PCS/CTN
HG-L249E-24W/2'x2'	24W	2760 LM	SMD 2835	605x605x76mm	640x100x640mm	1
HG-L249E-36W/2'x2'	36W	4140 LM	SMD 2835	605x605x76mm	640x100x640mm	1



ELECTRICAL COMPONENT

Osram, Philips, Tridonic or meanwell LED driver for 120V-277V/60Hz, 347V/60Hz, 240V/50Hz
Ideal or WAGO UL/CUL approved quick disconnect VDE approved terminal block
Everlight or Samsung LED Chips

SPECIFICATION

Die formed of 0.5mm cold-rolled steel body
All steel surface are painted after fabrication with high gloss backed white matte powder
High-diffusion light-milky PC diffuser
Fully recessed luminaire fits standard T-Grid ceilings.

OPTION

Available for dimmable version
Available for emergency version
Available for installing with sensor

APPLICATION

Shop / School / Office / Hotel / Conference Room / Hospital

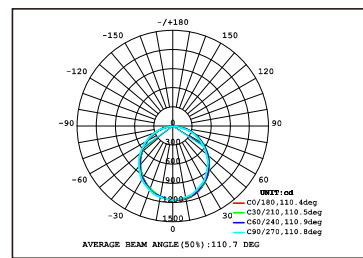
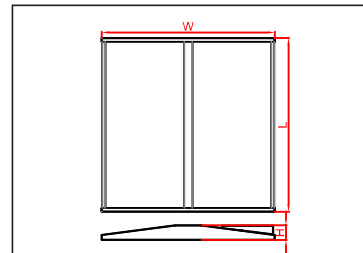

MODEL	WATTS	LUMEN	LED TYPE	LAMP SIZE (LxWxH)	PACKAGE SIZE	PCS/CTN
E2106-22-24W	24W	2760 LM	SMD 4014	603x603x50mm	655x135x655mm	2
E2106-22-36W	36W	4140 LM	SMD 4014	603x603x50mm	655x135x655mm	2
E2106-24-50W	50W	5750 LM	SMD 4014	603x603x50mm	655x135x655mm	2

ELECTRICAL COMPONENT

Osram, Philips, Tridonic or meanwell LED driver for 120V-277V/60Hz, 347V/60Hz, 240V/50Hz
Ideal or WAGO UL/CUL approved quick disconnect VDE approved terminal block
Everlight or Samsung LED Chips

SPECIFICATION

Die formed of 0.5mm cold-rolled steel body
All steel surface are painted after fabrication with high gloss backed white matte powder
High-diffusion light-milky PC diffuser
Fully recessed luminaire fits standard T-Grid ceilings.

OPTION

Available for dimmable version
Available for emergency version
Available for installing with sensor

APPLICATION

Shop / School / Office / Hotel / Conference Room / Hospital

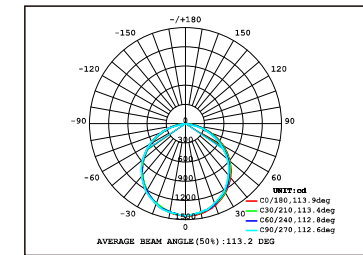
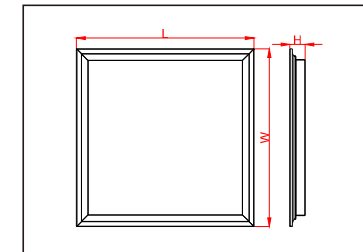

MODEL	WATTS	LUMEN	LED TYPE	LAMP SIZE (LxWxH)	PACKAGE SIZE	PCS/CTN
E2101-22-30W	30W	3450 LM	SMD 2835	603x603x50mm	645x120x650mm	2
E2101-22-40W	40W	4600 LM	SMD 2835	603x603x50mm	645x120x650mm	2
E2101-14-30W	30W	3450 LM	SMD 2835	1213x303x50mm	345x120x1250mm	2
E2101-14-40W	40W	4600 LM	SMD 2835	1213x303x50mm	345x120x1250mm	2
E2101-24-40W	40W	4600 LM	SMD 2835	1213x603x50mm	645x120x1250mm	2
E2101-24-50W	50W	5750 LM	SMD 2835	1213x603x50mm	645x120x1250mm	2

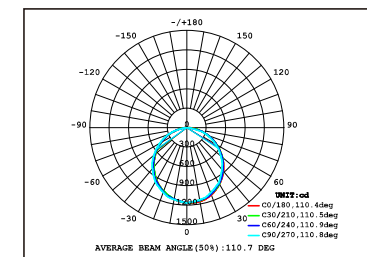
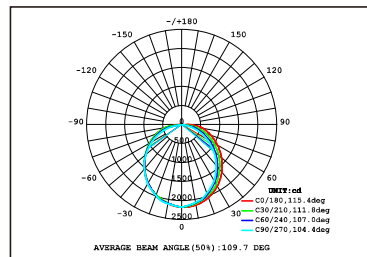
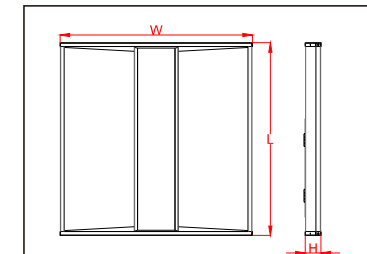
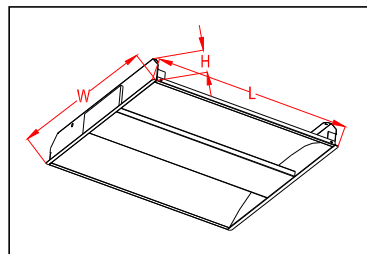

ELECTRICAL COMPONENT

Osram, Philips, Tridonic or meanwell LED driver for 120V-277V/60Hz, 347V/60Hz, 240V/50Hz
 Ideal or WAGO UL/CUL approved quick disconnect VDE approved terminal block
 Everlight or Samsung LED Chips

SPECIFICATION

Die formed of 0.6mm cold-rolled steel body
 All steel surface with high gloss backed white matte powder
 High reflectance backed white acrylic paint finished
 High-diffusion light-milky PC diffuser
 Fully recessed luminaire fits standard T-Grid ceilings.

OPTION

Available for dimmable version
 Available for emergency version
 Available for installing with sensor

APPLICATION

Shop / School / Office / Hotel / Conference Room / Hospital

ELECTRICAL COMPONENT

Osram, Philips, Tridonic or meanwell LED driver for 120V-277V/60Hz, 347V/60Hz, 240V/50Hz
 Ideal or WAGO UL/CUL approved quick disconnect VDE approved terminal block
 Everlight or Samsung LED Chips

SPECIFICATION

Die formed of 0.5mm cold-rolled steel body
 All steel surface are painted after fabrication with high gloss backed white matte powder
 High-diffusion light-milky PC diffuser
 Fully recessed luminaire fits standard T-Grid ceilings.

OPTION

Available for dimmable version
 Available for emergency version
 Available for installing with sensor

APPLICATION

Shop / School / Office / Hotel / Conference Room / Hospital

MODEL	WATTS	LUMEN	LED TYPE	LAMP SIZE (L X W X H)	PACKAGE SIZE	PCS/CTN
E1906-22-30W	30W	3450 LM	SMD 2835	603x603x80mm	645x105x650mm	1
E1906-22-40W	40W	4600 LM	SMD 2835	603x603x80mm	645x105x650mm	1
E1906-24-50W	50W	5750 LM	SMD 2835	603x603x80mm	645x105x1250mm	1

MODEL	WATTS	LUMEN	LED TYPE	LAMP SIZE (L X W X H)	PACKAGE SIZE	PCS/CTN
E2102-22-24W	24W	2760 LM	SMD 4014	603x603x50mm	655x135x655mm	2
E2102-22-36W	36W	4140 LM	SMD 4014	603x603x50mm	655x135x655mm	2
E2102-24-50W	50W	5750 LM	SMD 4014	603x603x50mm	655x135x655mm	2

UP AND DOWN LED LIGHT



UP AND DOWN LED LIGHT

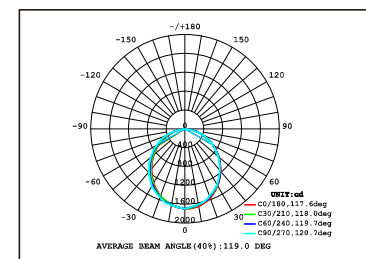
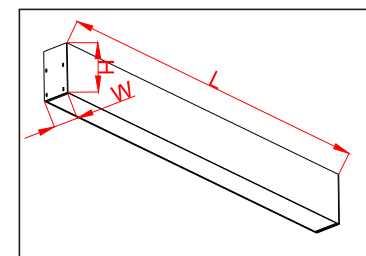

ELECTRICAL COMPONENT

Osram, Philips, Tridonic or meanwell LED driver for 120V-277V/60Hz, 347V/60Hz, 240V/50Hz
 Ideal or WAGO UL/CUL approved quick disconnect VDE approved terminal block
 Everlight or Samsung LED Chips

SPECIFICATION

Housing: extruded aluminum material with anodized or powder coated on surface
 Diffuser: extruded opal polycarbonate material with UV protection
 LED Plate: 0.4mm pressed & folded steel sheet with epoxy powder coated
 With 1 meter stainless wire for suspension

OPTION

Available for installing with dimmable & emergency kits
 Available for installing with sensor
 Available for hanging

APPLICATION

Shop / School / Office / Hotel / Conference Room / Hospital

Halcon Lighting-UP AND DOWN LED LIGHT

Browse a wide range of Up & Down Lights at Halcon Lighting.

Up and Down Lights are a great way of creating atmosphere in the office.

MODEL	WATTS	LUMEN	LED TYPE	LAMP SIZE (L X W X H)	PACKAGE SIZE	PCS/CTN
HG-L242B-40W/4ft	40W	4600 LM	SMD 2835	1174x67x115mm	1230x195x175mm	6
HG-L242B-50W/4ft	50W	5750 LM	SMD 2835	1174x67x115mm	1230x195x175mm	6



LED PENDANT LIGHT

LED PENDANT LIGHT

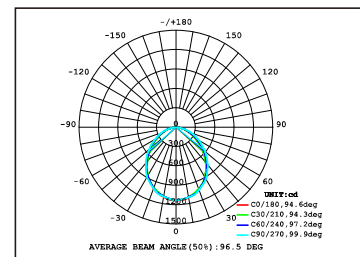
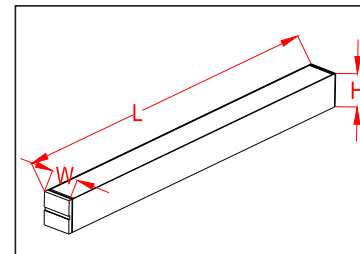
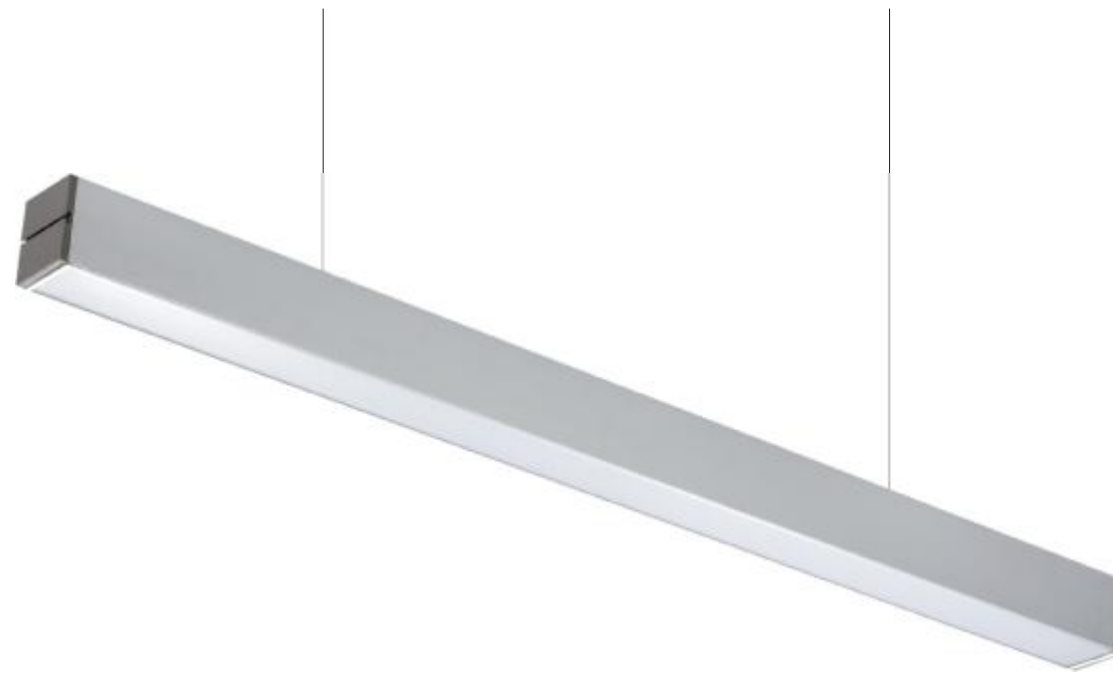

ELECTRICAL COMPONENT

Osram, Philips, Tridonic or meanwell LED driver for 120V-277V/60Hz, 347V/60Hz, 240V/50Hz
Ideal or WAGO UL/CUL approved quick disconnecter VDE approved terminal block
Everlight or Samsung LED Chips

SPECIFICATION

Housing: extruded aluminum material with anodized or powder coated on surface
Diffuser: extruded opal polycarbonate material with UV protection
LED Plate: 0.4mm pressed & folded steel sheet with epoxy powder coated
With 1 meter stainless wire for suspension

OPTION

Available for installing with dimmable & emergency kits
Available for installing with sensor
Available for hanging

APPLICATION

Shop / School / Office / Hotel / Conference Room / Hospital

Halcon Lighting - LED PENDANT LIGHT

It adopts high quality aluminum alloy section lamp body, the lamp body line is strong and beautiful, the structure is reasonable, installation and maintenance is convenient and flexible. The high light transmittance PAMM mask makes the light effect more bright and the light more uniform. The perfect combination of the light control mask and the lamp body makes Deng Yi more beautiful, with less flash and more eye protection.

MODEL	WATTS	LUMEN	LED TYPE	LAMP SIZE (LxWxH)	PACKAGE SIZE	PCS/CTN
HG-L242-40W/4ft	40W	4600 LM	SMD 2835	1164x67x75mm	1205x260x230mm	6
HG-L242-50W/5ft	50W	5750 LM	SMD 2835	1474x67x75mm	1515x260x230mm	6

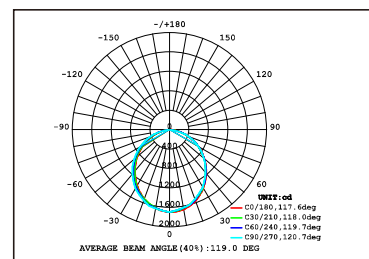
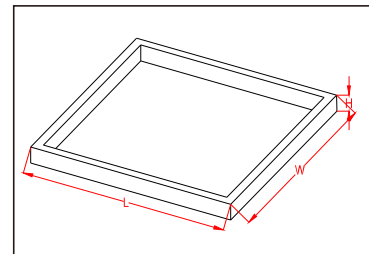

ELECTRICAL COMPONENT

Osram, Philips, Tridonic or meanwell LED driver for 120V-277V/60Hz, 347V/60Hz, 240V/50Hz
 Ideal or WAGO UL/CUL approved quick disconnect VDE approved terminal block
 Everlight or Samsung LED Chips

SPECIFICATION

Housing: extruded aluminum material with anodized or powder coated on surface
 Diffuser: extruded opal polycarbonate material with UV protection
 LED Plate: 0.4mm pressed & folded steel sheet with epoxy powder coated
 With 1 meter stainless wire for suspension

OPTION

Available for installing with dimmable & emergency kits
 Available for installing with sensor
 Available for hanging

APPLICATION

Shop / School / Office / Hotel / Conference Room / Hospital



HG-L242S-X



HG-L242S-T



HG-L242S-L

MODEL	WATTS	LUMEN	LED TYPE	LAMP SIZE (L X W X H)	PACKAGE SIZE	PCS/CTN
HG-L242-44/60W	60W	6900 LM	SMD 2835	1160x1160x75mm	1200x1200x100mm	1
HG-L242-44/80W	80W	9200 LM	SMD 2835	1160x1160x75mm	1200x1200x100mm	1

MODEL	WATTS	LUMEN	LED TYPE	LAMP SIZE (L X W X H)	PACKAGE SIZE	PCS/CTN
HG-L242S-254F	25W	2875 LM	SMD 2835	1165x50x100mm	1210x360x125mm	6
HG-L242S-404F	40W	4600 LM	SMD 2835	1165x50x100mm	1210x360x125mm	6
HG-L242S-808F	80W	9200 LM	SMD 2835	2438x50x100mm	2480x245x125 mm	4

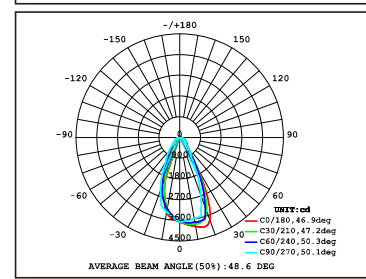
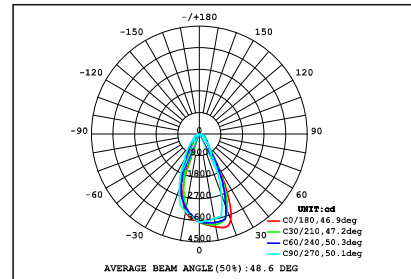
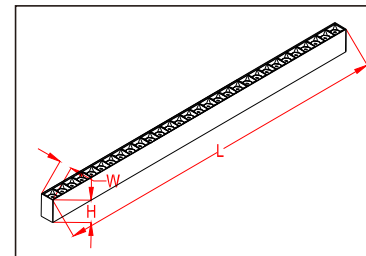
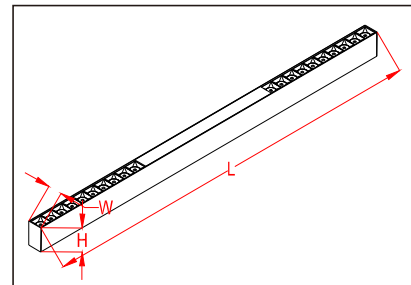

ELECTRICAL COMPONENT

Osram, Philips, Tridonic or meanwell LED driver for 120V-277V/60Hz, 347V/60Hz, 240V/50Hz
 Ideal or WAGO UL/CUL approved quick disconnect VDE approved terminal block
 Everlight or Samsung LED Chips

SPECIFICATION

Housing: extruded aluminum material with anodized or powder coated on surface
 With 1 meter stainless wire for suspension

OPTION

Available for installing with dimmable & emergency kits
 Available for installing with sensor
 Available for hanging

APPLICATION

Shop / School / Office / Hotel / Conference Room / Hospital

ELECTRICAL COMPONENT

Osram, Philips, Tridonic or meanwell LED driver for 120V-277V/60Hz, 347V/60Hz, 240V/50Hz
 Ideal or WAGO UL/CUL approved quick disconnect VDE approved terminal block
 Everlight or Samsung LED Chips

SPECIFICATION

Housing: extruded aluminum material with anodized or powder coated on surface
 With 1 meter stainless wire for suspension

OPTION

Available for installing with dimmable & emergency kits
 Available for installing with sensor
 Available for hanging

APPLICATION

Shop / School / Office / Hotel / Conference Room / Hospital

MODEL	WATTS	LUMEN	LED TYPE	LAMP SIZE (L X W X H)	PACKAGE SIZE	PCS/CTN
P2001B-18W/2FT	18W	2070 LM	SMD 3030	573x43x75mm	730x270x145mm	5
P2001B-36W/4FT	36W	4140 LM	SMD 3030	1143x43x75mm	1300x270x145mm	5
P2001B-50W/5FT	50W	5750 LM	SMD 3030	1520x43x75mm	1720x65x1220mm	5

MODEL	WATTS	LUMEN	LED TYPE	LAMP SIZE (L X W X H)	PACKAGE SIZE	PCS/CTN
P2001A-18W/2FT	18W	2070LM	SMD 3030	573x43x75mm	730x270x145mm	5
P2001A-36W/4FT	36W	4140 LM	SMD 3030	1143x43x75mm	1300x270x145mm	5
P2001A-50W/5FT	50W	5750 LM	SMD 3030	1520x43x75mm	1720x65x1220mm	5

LED PENDANT LIGHT

LED PENDANT LIGHT

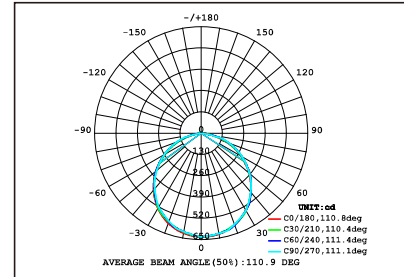
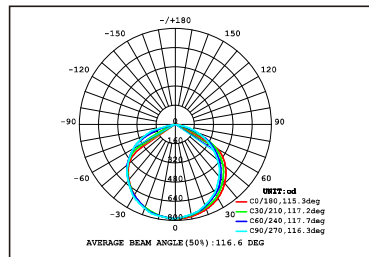
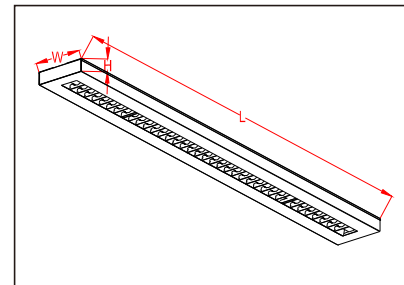
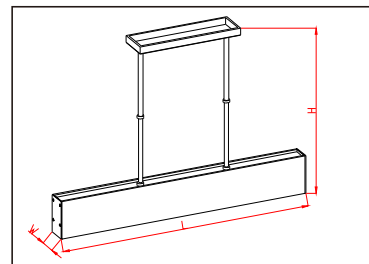

ELECTRICAL COMPONENT

Osram, Philips, Tridonic or meanwell LED driver for 120V-277V/60Hz, 347V/60Hz, 240V/50Hz
 Ideal or WAGO UL/CUL approved quick disconnect VDE approved terminal block
 Everlight or Samsung LED Chips

SPECIFICATION

Housing: extruded aluminum material with anodized or powder coated on surface
 Diffuser: extruded opal polycarbonate material with UV protection
 LED Plate: 0.4mm pressed & folded steel sheet with epoxy powder coated

OPTION

Available for installing with dimmable & emergency kits
 Available for installing with sensor
 Available for hanging

APPLICATION

Shop / School / Office / Hotel / Conference Room / Hospital

ELECTRICAL COMPONENT

Osram, Philips, Tridonic or meanwell LED driver for 120V-277V/60Hz, 347V/60Hz, 240V/50Hz
 Ideal or WAGO UL/CUL approved quick disconnect VDE approved terminal block
 Everlight or Samsung LED Chips

SPECIFICATION

Housing: extruded aluminum material with anodized or powder coated on surface
 With 1 meter stainless wire for suspension

OPTION

Available for installing with dimmable & emergency kits
 Available for installing with sensor
 Available for hanging

APPLICATION

Shop / School / Office / Hotel / Conference Room / Hospital

MODEL	WATTS	LUMEN	LED TYPE	LAMP SIZE (L X W X H)	PACKAGE SIZE	PCS/CTN
C2105-2FT	LED 20W	2300 LM	SMD2835	605x50x730mm	645x260x180mm	4
C2105-3FT	LED 30W	3450 LM	SMD2835	905x50x730mm	945x260x180mm	4
C2105-4FT	LED 40W	4600 LM	SMD2835	1165x50x730mm	1305x260x180mm	4

MODEL	WATTS	LUMEN	LED TYPE	LAMP SIZE (L X W X H)	PACKAGE SIZE	PCS/CTN
P1836-30W/4FT	30W	3450LM	SMD 3030	573x43x75mm	730x270x145mm	5
P1836-40W/4FT	40W	4600 LM	SMD 3030	1143x43x75mm	1300x270x145mm	5
P1836-50W/5FT	50W	5750 LM	SMD 3030	1520x43x75mm	1720x65x1220mm	5



LED CEILING LIGHT

Halcon lighting



LED CEILING LIGHT



ELECTRICAL COMPONENT

Osram, Philips, Tridonic or meanwell LED driver for 120V-277V/60Hz, 347V/60Hz, 240V/50Hz
Ideal or WAGO UL/CUL approved quick disconnect VDE approved terminal block
Everlight or Samsung LED Chips

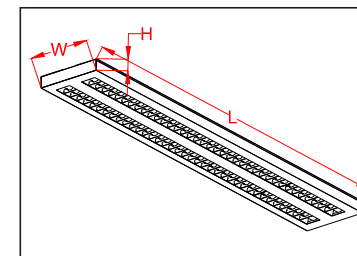

SPECIFICATION

Housing: extruded aluminum material with anodized or powder coated on surface

OPTION

Available for installing with dimmable & emergency kits
Available for installing with sensor
Available for hanging

APPLICATION

Shop / School / Office / Hotel / Conference Room / Hospital

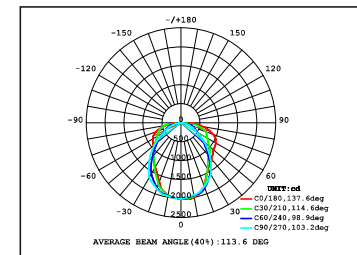

Halcon Lighting - LED CEILING LIGHT

LED ceiling lights are every inch as practical and beautiful as standard ceiling lights, with one huge added benefit. With bulbs that use 90% less energy, you'll save a fortune on electricity costs... and help save the Earth, too. Ceiling lights are perfect for rooms with low ceilings as they don't take up much space, and they offer a great source of general lighting, with light beautifully and evenly distributed throughout the room.

MODEL	WATTS	LUMEN	LED TYPE	LAMP SIZE (LxWxH)	PACKAGE SIZE	PCS/CTN
HG-L238-14/40W	40W	4600 LM	SMD 2835	1213x303x50mm	340x75x1250mm	1
HG-L238-22/40W	40W	4600 LM	SMD 2835	603x603x50mm	640x75x645mm	1
HG-L238-24/60W	60W	6900 LM	SMD 2835	1213x603x50mm	640x75x1250mm	1



ELECTRICAL COMPONENT

Osram, Philips, Tridonic or meanwell LED driver for 120V-277V/60Hz, 347V/60Hz, 240V/50Hz
 Ideal or WAGO UL/CUL approved quick disconnect VDE approved terminal block
 Everlight or Samsung LED Chips

SPECIFICATION

Die formed of 0.5mm cold-rolled steel body
 All steel surface are painted after fabrication with high gloss backed white coated powder
 High reflectance backed white acrylic paint finished
 High-diffusion light-milky PC diffuser

OPTION

Available for installing with dimmable & emergency kits
 Available for installing with sensor
 Available for hanging

APPLICATION

Shop / School / Office / Hotel / Conference Room / Hospital

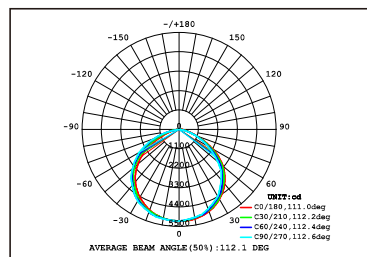
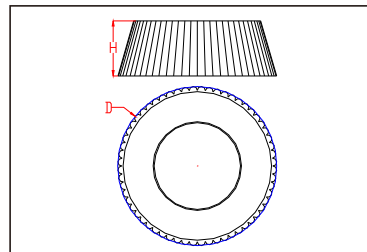

ELECTRICAL COMPONENT

Osram, Philips, Tridonic or meanwell LED driver for 120V-277V/60Hz, 347V/60Hz, 240V/50Hz
 Ideal or WAGO UL/CUL approved quick disconnect VDE approved terminal block
 Everlight or Samsung LED Chips

SPECIFICATION

Die formed of 0.5mm cold-rolled steel body
 All steel surface are painted after fabrication with high gloss backed white coated powder
 High reflectance backed white acrylic paint finished
 High-diffusion light-milky PC diffuser

OPTION

Available for installing with dimmable & emergency kits
 Available for installing with sensor
 Available for hanging

APPLICATION

Shop / School / Office / Hotel / Conference Room / Hospital

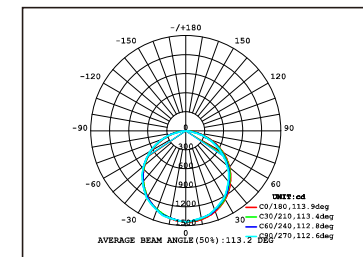
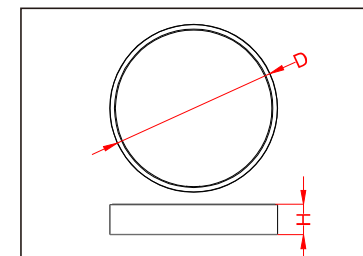

MODEL	WATTS	LUMEN	LED TYPE	LAMP SIZE (L X W X H)	PACKAGE SIZE	PCS/CTN
P2107-30W	LED 30W	3450 LM	SMD 2835	455x155mm	500x500x200mm	1
P2107-40W	LED 40W	4600 LM	SMD 2835	455x155mm	500x500x200mm	1
C2107-30W	LED 30W	3450 LM	SMD 2835	455x185mm	500x500x200mm	1
C2107-40W	LED 40W	4600 LM	SMD 2835	455x185mm	500x500x200mm	1

MODEL	WATTS	LUMEN	LED TYPE	LAMP SIZE (L X W X H)	PACKAGE SIZE	PCS/CTN
C1902-360/30W	30W	3450 LM	SMD2835	360x65mm	410x410x100mm	1
C1902-480/40W	40W	4600 LM	SMD2835	480x65mm	530x530x100mm	1
C1902-600/50W	50W	5750 LM	SMD2835	600x65mm	650x650x100mm	1

LED ROUND PENDANT LIGHT

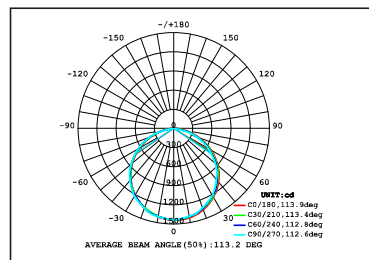
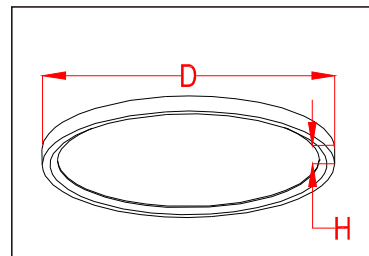

ELECTRICAL COMPONENT
 Osram, Philips, Tridonic or meanwell LED driver for 120V-277V/60Hz, 347V/60Hz, 240V/50Hz
 Ideal or WAGO UL/CUL approved quick disconnect VDE approved terminal block
 Everlight or Samsung LED Chips

SPECIFICATION
 Die formed of 0.5mm cold-rolled steel body
 All steel surface are painted after fabrication with high gloss backed white coated powder
 High reflectance backed white acrylic paint finished
 High-diffusion light-milky PC diffuser

OPTION
 Available for installing with dimmable & emergency kits
 Available for installing with sensor
 Available for hanging

APPLICATION
 Shop / School / Office / Hotel / Conference Room / Hospital

MODEL	WATTS	LUMEN	LED TYPE	LAMP SIZE (L X W X H)	PACKAGE SIZE	PCS/CTN
P1908-360/30W	30W	3450 LM	SMD 2835	360x20mm	410x410x55mm	1
P1908-480/40W	40W	4600 LM	SMD 2835	480x20mm	530x530x55mm	1

LED CABINET LIGHT

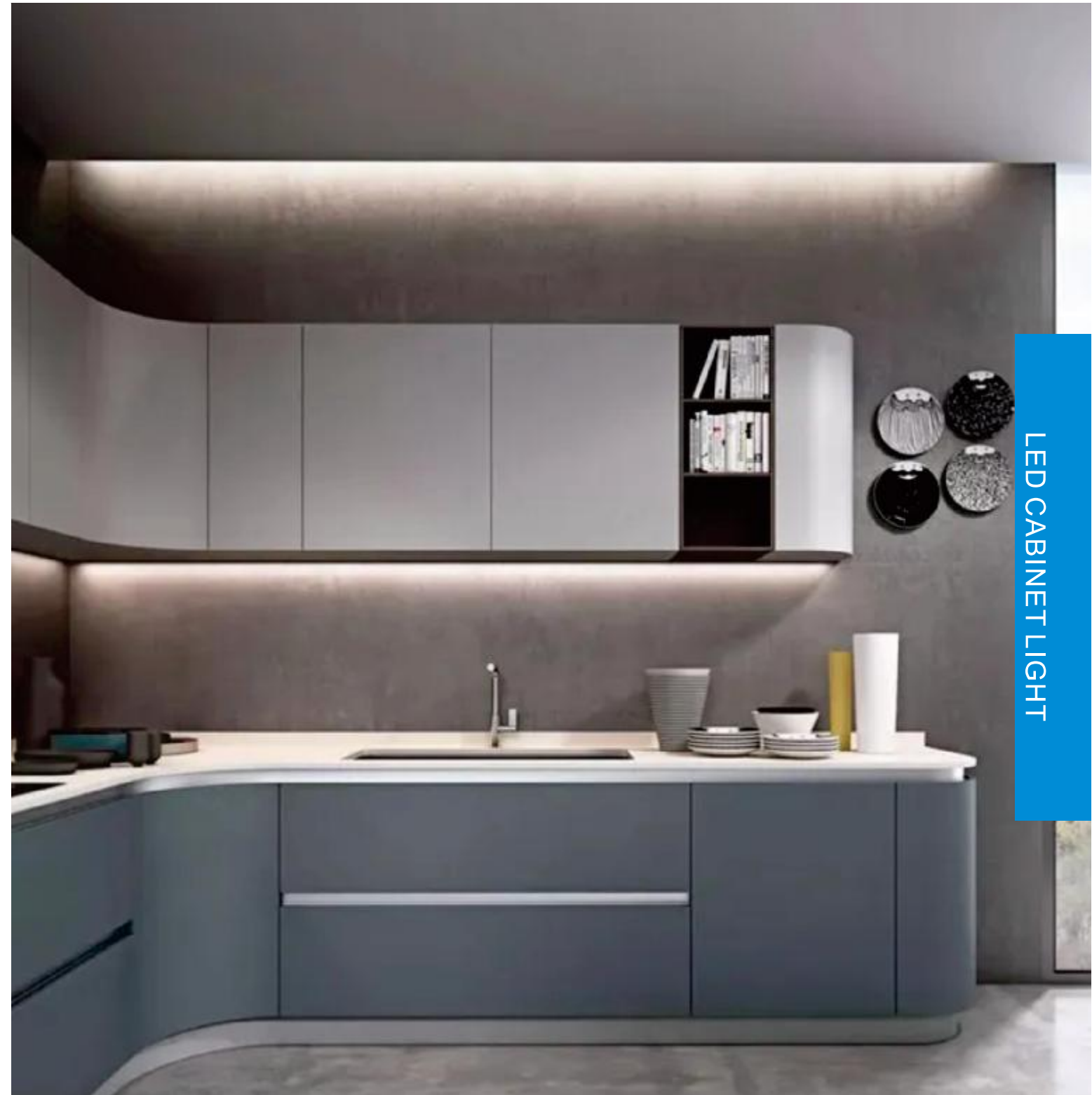

Halcon Lighting - LED CABINET LIGHT

Under cabinet lighting has become popular for both practical and aesthetic purposes. These slim, focused light fixtures provide task lighting over counters, sinks, and prep areas. At the same time, the soft glow from under cabinet lighting is a great way to illuminate the space without the harsh glow of a powerful overhead light.

LED UNDER CABINET LIGHT

LED UNDER CABINET LIGHT

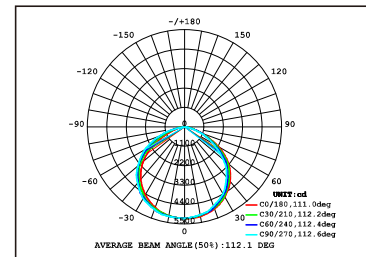
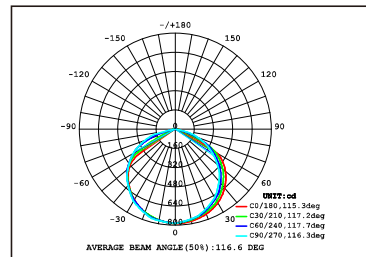
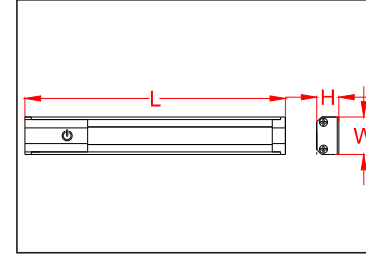
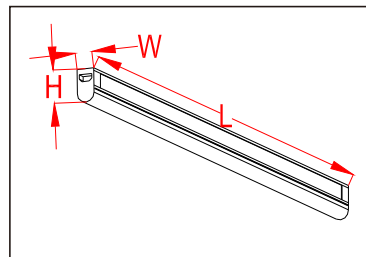
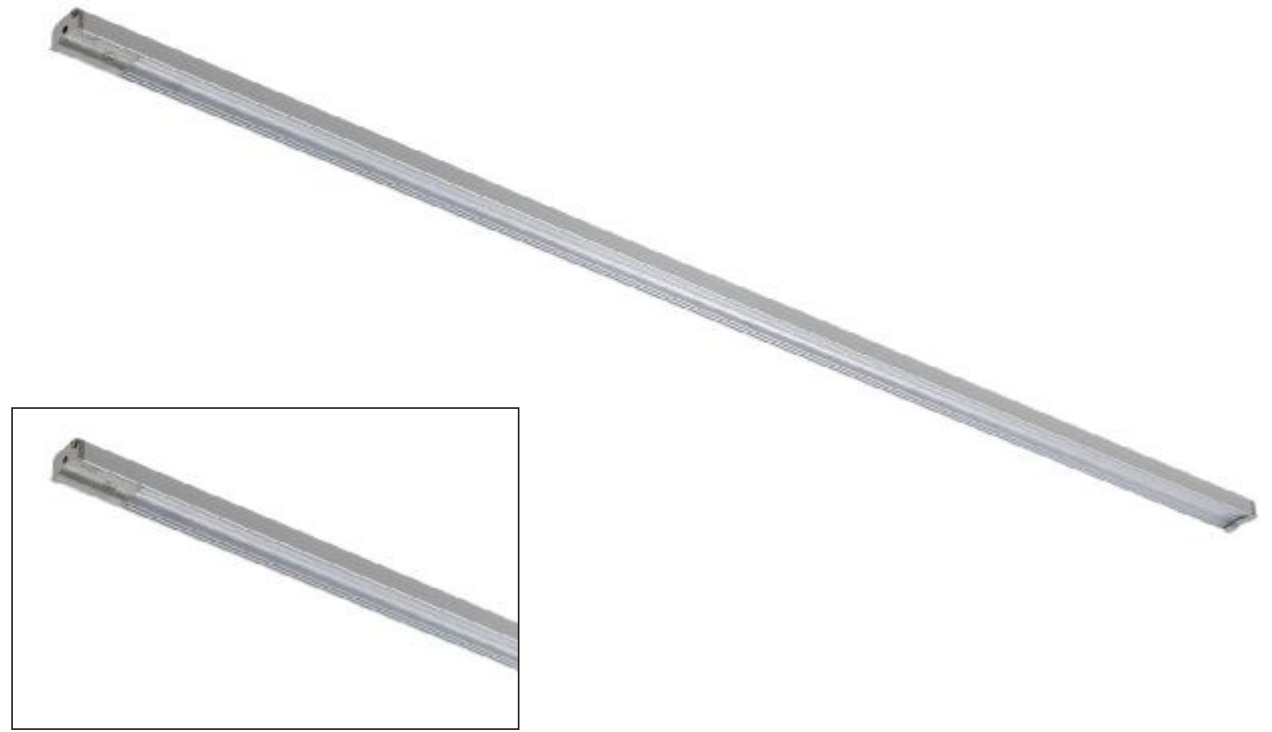

ELECTRICAL COMPONENT

Osram, Philips, Tridonic or meanwell LED driver for 120V-277V/60Hz, 347V/60Hz, 240V/50Hz
Ideal or WAGO UL/CUL approved quick disconnect VDE approved terminal block
Everlight or Samsung LED Chips

SPECIFICATION

Die formed of 0.5mm cold-rolled steel body
All steel surface are painted after fabrication with high gloss backed white coated powder
High reflectance backed white acrylic paint finished
High-diffusion light-milky PC diffuser

OPTION

Available for installing with dimmable & emergency kits
Available for installing with sensor
Available for hanging

APPLICATION

Shop / School / Office / Hotel / Conference Room / Hospital

ELECTRICAL COMPONENT

Osram, Philips, Tridonic or meanwell LED driver for 120V-277V/60Hz, 347V/60Hz, 240V/50Hz
Ideal or WAGO UL/CUL approved quick disconnect VDE approved terminal block
Everlight or Samsung LED Chips

SPECIFICATION

Die formed of 0.5mm cold-rolled steel body
All steel surface are painted after fabrication with high gloss backed white coated powder
High reflectance backed white acrylic paint finished
High-diffusion light-milky PC diffuser

OPTION

Available for installing with dimmable & emergency kits
Available for installing with sensor
Available for hanging

APPLICATION

Shop / School / Office / Hotel / Conference Room / Hospital

MODEL	WATTS	LUMEN	LED TYPE	LAMP SIZE (L X W X H)	PACKAGE SIZE	PCS/CTN
HG-L250-2'	LED 10W	1100 LM	SMD2835	582x20x37mm	630x150x210mm	20
HG-L250-3'	LED 15W	1650 LM	SMD2835	882x20x37mm	930x150x210mm	20
HG-L250-4'	LED 20W	2200 LM	SMD2835	1182x20x37mm	1230x150x210mm	20
HG-L250-5'	LED 25W	2750 LM	SMD2835	1482x20x37mm	1530x150x210mm	20

MODEL	WATTS	LUMEN	LED TYPE	LAMP SIZE (L X W X H)	PACKAGE SIZE	PCS/CTN
YLED120	LED 10W	1100 LM	SMD 5050	311x24x14.2mm	365x145x115mm	25
YLED240	LED 15W	1650 LM	SMD 5050	581x24x14.2mm	635x145x115mm	25
YLED360	LED 18W	1980 LM	SMD 5050	851x24x14.2mm	905x145x115mm	25
YLED480	LED 25W	2750 LM	SMD 5050	1121x24x14.2mm	1175x145x115mm	25
YLED600	LED 30W	3300 LM	SMD 5050	1391x24x14.2mm	1445x145x115mm	25

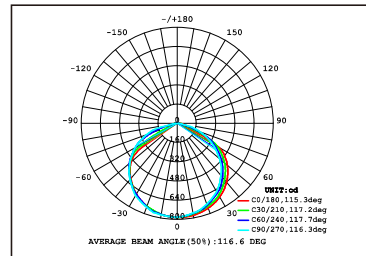
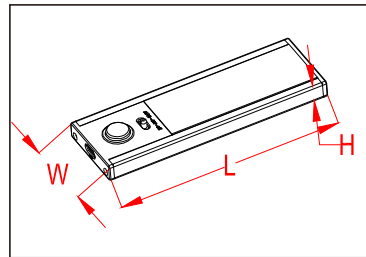

ELECTRICAL COMPONENT

Osram, Philips, Tridonic or meanwell LED driver for 120V-277V/60Hz, 347V/60Hz, 240V/50Hz
 Ideal or WAGO UL/CUL approved quick disconnect VDE approved terminal block
 Everlight or Samsung LED Chips

SPECIFICATION

Die formed of 0.5mm cold-rolled steel body
 All steel surface are painted after fabrication with high gloss backed white coated powder
 High reflectance backed white acrylic paint finished
 High-diffusion light-milky PC diffuser

OPTION

Available for installing with dimmable & emergency kits
 Available for installing with sensor
 Available for hanging

APPLICATION

Shop / School / Office / Hotel / Conference Room / Hospital

MODEL	WATTS	LUMEN	LED TYPE	LAMP SIZE (L X W X H)	PACKAGE SIZE	PCS/CTN
W2008-125	LED 0.6W	60 LM	SMD4014	125x40x9mm	310x245x110mm	60
W2008-245	LED 1.3W	130 LM	SMD4014	245x40x9mm	550x245x110mm	60
W2008-400	LED 2.5W	250 LM	SMD4014	400x40x9mm	440x245x110mm	30
W2008-600	LED 3W	300 LM	SMD4014	600x40x9mm	640x245x110mm	30
W2008-800	LED 3.5W	350 LM	SMD4014	800x40x9mm	840x245x110mm	30
W2008-1000	LED 4W	400 LM	SMD4014	1000x40x9mm	840x245x110mm	30

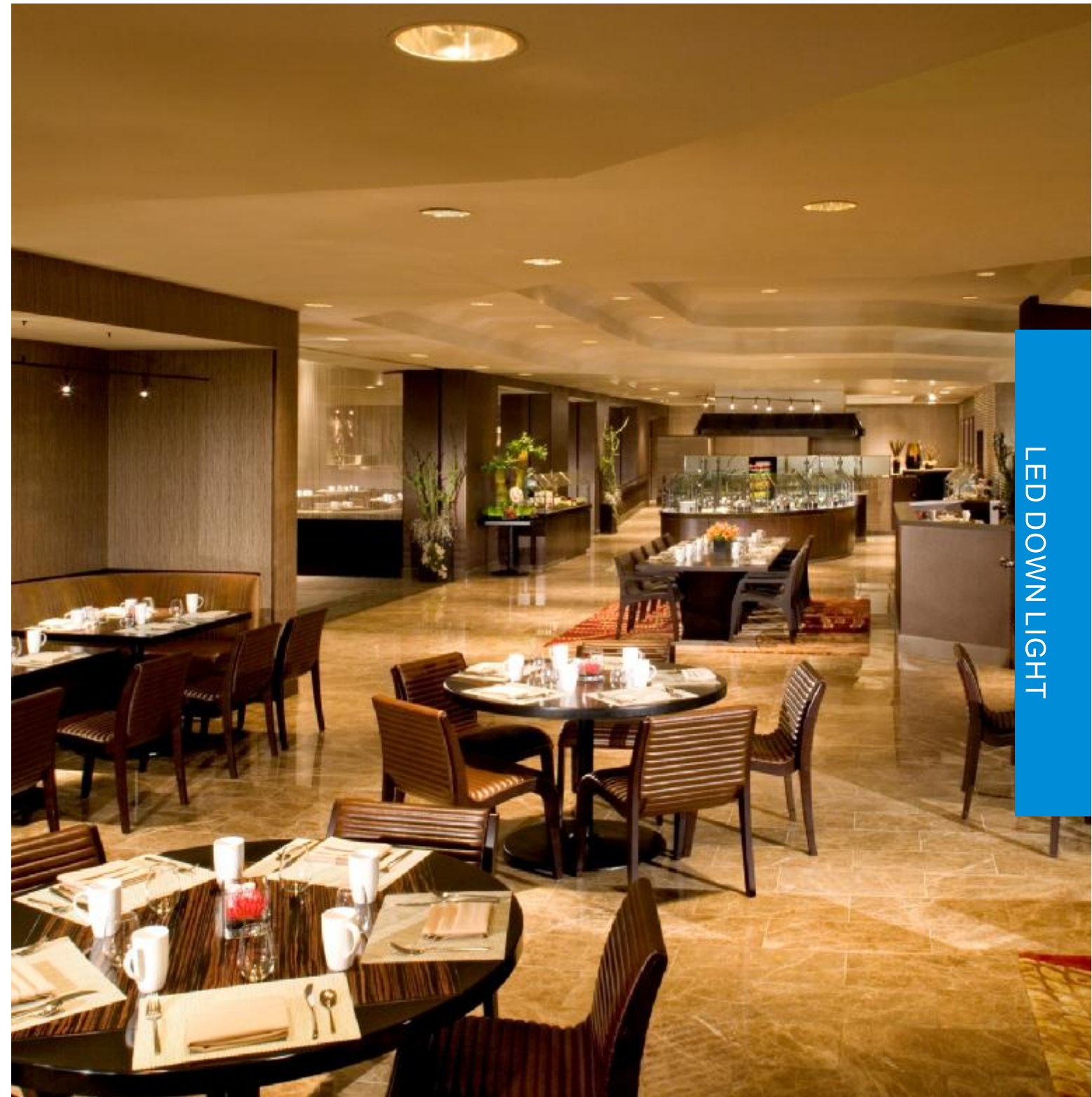

Halcon Lighting -LED DOWN LIGHT

LED downlights are a discrete, low energy lighting solution.

.Halcon was originally designed as a low energy alternative to replace incandescent, fluorescent and halogen. With most of these lamp options now banned altogether, LED remains the only viable lighting option,. It's become so good, that their doesn't really need to be anything else.

we offer a large selection of GU10 and integrated LED downlights. We offer expert advice and can help you choose the best options for your project.

LED SQUARE DOWN LIGHT

LED ROUND DOWN LIGHT

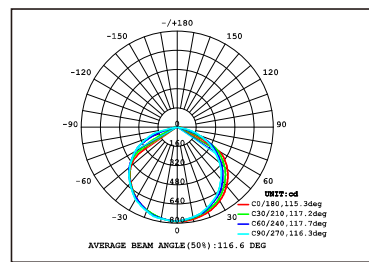
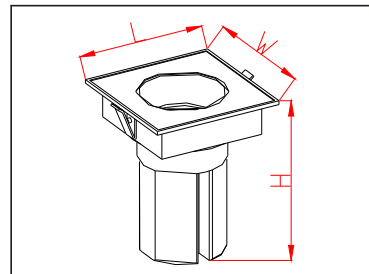

ELECTRICAL COMPONENT

Osram, Philips, Tridonic or meanwell LED driver for 120V-277V/60Hz, 347V/60Hz, 240V/50Hz
 Ideal or WAGO UL/CUL approved quick disconnect VDE approved terminal block
 Everlight or Samsung LED Chips

SPECIFICATION

Die casting aluminum lamp body
 backed white coated powder
 High reflectance backed white acrylic paint finished

OPTION

Available for installing with dimmable & emergency kits
 Available for installing with sensor
 Available for hanging

APPLICATION

Shop / School / Office / Hotel / Conference Room / Hospital

MODEL	WATTS	LUMEN	LED TYPE	LAMP SIZE (L X W X H)	PACKAGE SIZE	PCS/CTN
E2108A-3in	LED 12W	1380 LM	COB	90x90x110mm	300x300x245mm	18
E2108A-4in	LED 18W	2070 LM	COB	105x105x113mm	345x345x250mm	18
E2108A-5in	LED 30W	3450 LM	COB	140x140x165mm	305x305x355mm	8
E2108A-6in	LED 40W	4600 LM	COB	160x160x185mm	345x345x205mm	4

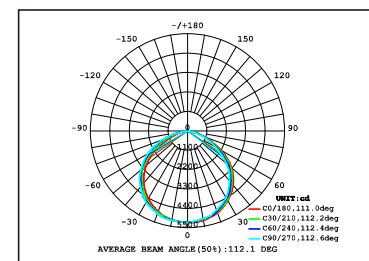
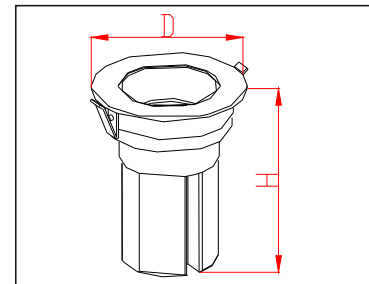

ELECTRICAL COMPONENT

Osram, Philips, Tridonic or meanwell LED driver for 120V-277V/60Hz, 347V/60Hz, 240V/50Hz
 Ideal or WAGO UL/CUL approved quick disconnect VDE approved terminal block
 Everlight or Samsung LED Chips

SPECIFICATION

Die casting aluminum lamp body
 backed white coated powder
 High reflectance backed white acrylic paint finished

OPTION

Available for installing with dimmable & emergency kits
 Available for installing with sensor
 Available for hanging

APPLICATION

Shop / School / Office / Hotel / Conference Room / Hospital

MODEL	WATTS	LUMEN	LED TYPE	LAMP SIZE (L X W X H)	PACKAGE SIZE	PCS/CTN
E2108B-3in	LED 12W	1380 LM	COB	90x110mm	300x300x245mm	18
E2108B-4in	LED 18W	2070 LM	COB	105x113mm	345x345x250mm	18
E2108B-5in	LED 30W	3450 LM	COB	140x165mm	305x305x355mm	8
E2108B-6in	LED 40W	4600 LM	COB	160x185mm	345x345x205mm	4

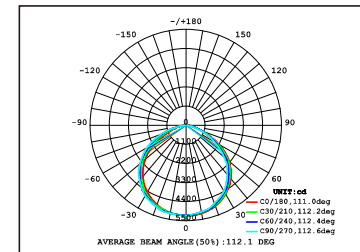
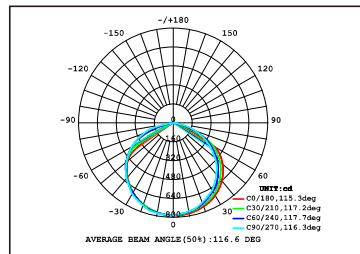
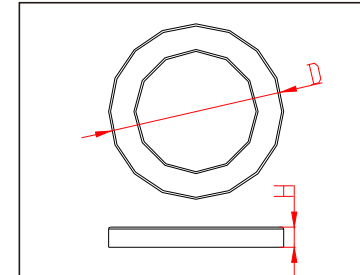
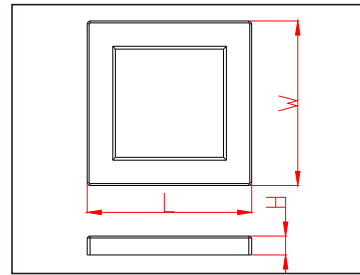

ELECTRICAL COMPONENT

Osram, Philips, Tridonic or meanwell LED driver for 120V-277V/60Hz, 347V/60Hz, 240V/50Hz
 Ideal or WAGO UL/CUL approved quick disconnect VDE approved terminal block
 Everlight or Samsung LED Chips

SPECIFICATION

Die casting aluminum lamp body
 backed white coated powder
 High reflectance backed white acrylic paint finished
 High-diffusion light-milky PC diffuser

OPTION

Available for installing with dimmable & emergency kits
 Available for installing with sensor
 Available for hanging

APPLICATION

Shop / School / Office / Hotel / Conference Room / Hospital

ELECTRICAL COMPONENT

Osram, Philips, Tridonic or meanwell LED driver for 120V-277V/60Hz, 347V/60Hz, 240V/50Hz
 Ideal or WAGO UL/CUL approved quick disconnect VDE approved terminal block
 Everlight or Samsung LED Chips

SPECIFICATION

Die casting aluminum lamp body
 backed white coated powder
 High reflectance backed white acrylic paint finished
 High-diffusion light-milky PC diffuser

OPTION

Available for installing with dimmable & emergency kits
 Available for installing with sensor
 Available for hanging

APPLICATION

Shop / School / Office / Hotel / Conference Room / Hospital

MODEL	WATTS	LUMEN	LED TYPE	LAMP SIZE (L X W X H)	PACKAGE SIZE	PCS/CTN
E2109A-9W	LED 9W	1035 LM	SMD2835	155x155x20mm	540x330x385mm	60
E2109A-12W	LED 12W	1380 LM	SMD2835	175x175x20mm	405x330x425mm	40
E2109A-18W	LED 18W	2070 LM	SMD2835	225x225x20mm	505x330x270mm	20
E2109A-24W	LED 24W	2760 LM	SMD2835	300x300x20mm	665x330x350mm	20

MODEL	WATTS	LUMEN	LED TYPE	LAMP SIZE (L X W X H)	PACKAGE SIZE	PCS/CTN
E2109B-9W	LED 9W	1035 LM	SMD 2835	155x20mm	540x330x385mm	60
E2109B-12W	LED 12W	1380 LM	SMD 2835	175x20mm	405x330x425mm	40
E2109B-18W	LED 18W	2070 LM	SMD 2835	225x20mm	505x330x270mm	20
E2109B-24W	LED 24W	2760 LM	SMD 2835	300x20mm	665x330x350mm	20

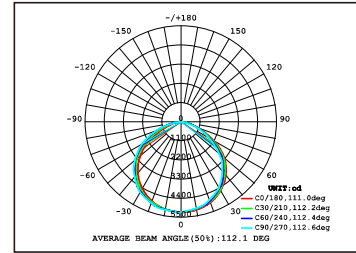
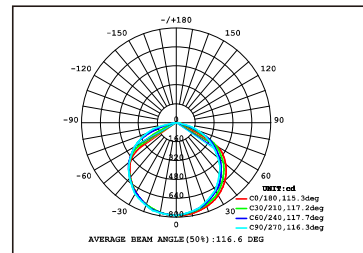
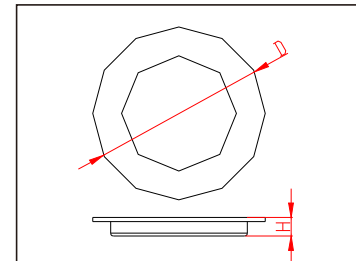
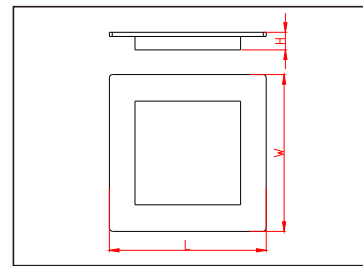

ELECTRICAL COMPONENT

Osram, Philips, Tridonic or meanwell LED driver for 120V-277V/60Hz, 347V/60Hz, 240V/50Hz
 Ideal or WAGO UL/CUL approved quick disconnect VDE approved terminal block
 Everlight or Samsung LED Chips

SPECIFICATION

Die casting aluminum lamp body backed white coated powder
 High reflectance backed white acrylic paint finished
 High-diffusion light-milky PC diffuser

OPTION

Available for dimmable version
 Available for emergency version
 Available for installing with sensor

APPLICATION

Shop / School / Office / Hotel / Conference Room / Hospital

ELECTRICAL COMPONENT

Osram, Philips, Tridonic or meanwell LED driver for 120V-277V/60Hz, 347V/60Hz, 240V/50Hz
 Ideal or WAGO UL/CUL approved quick disconnect VDE approved terminal block
 Everlight or Samsung LED Chips

SPECIFICATION

Die casting aluminum lamp body backed white coated powder
 High reflectance backed white acrylic paint finished
 High-diffusion light-milky PC diffuser

OPTION

Available for dimmable version
 Available for emergency version
 Available for installing with sensor

APPLICATION

Shop / School / Office / Hotel / Conference Room / Hospital

MODEL	WATTS	LUMEN	LED TYPE	LAMP SIZE (L X W X H)	PACKAGE SIZE	PCS/CTN
E2110A-3W	LED 3W	345 LM	SMD2835	88x88x23mm	490x310x260mm	100
E2110A-4W	LED 4W	450 LM	SMD2835	110x110x23mm	640x310x165mm	50
E2110A-6W	LED 6W	690 LM	SMD2835	120x120x23mm	640x310x165mm	50
E2110A-9W	LED 9W	1035 LM	SMD2835	148x148x23mm	540x310x220mm	30
E2110A-12W	LED 12W	1380 LM	SMD2835	170x170x23mm	540x310x220mm	20
E2110A-15W	LED 15W	1725 LM	SMD2835	190x190x23mm	460x310x270mm	20
E2110A-18W	LED 18W	1980 LM	SMD2835	220x220x23mm	460x310x270mm	20
E2110A-24W	LED 24W	2070 LM	SMD2835	300x300x23mm	620x310x350mm	20
E2110A-30W	LED 30W	3450 LM	SMD2835	300x300x23mm	620x310x350mm	20

MODEL	WATTS	LUMEN	LED TYPE	LAMP SIZE (L X W X H)	PACKAGE SIZE	PCS/CTN
E2110B-3W	LED 3W	345 LM	SMD2835	85x23mm	490x310x260mm	100
E2110B-4W	LED 4W	450 LM	SMD2835	110x23mm	640x310x165mm	50
E2110B-6W	LED 6W	690 LM	SMD2835	120x23mm	640x310x165mm	50
E2110B-9W	LED 9W	1035 LM	SMD2835	148x23mm	540x310x220mm	30
E2110B-12W	LED 12W	1380 LM	SMD2835	170x23mm	540x310x220mm	20
E2110B-15W	LED 15W	1725 LM	SMD2835	190x23mm	460x310x270mm	20
E2110B-18W	LED 18W	1980 LM	SMD2835	220x23mm	460x310x270mm	20
E2110B-24W	LED 24W	2070 LM	SMD2835	300x23mm	620x310x350mm	20
E2110B-30W	LED 30W	3450 LM	SMD2835	300x23mm	620x310x350mm	20



ELECTRICAL COMPONENT

Osram, Philips, Tridonic or meanwell LED driver for 120V-277V/60Hz, 347V/60Hz, 240V/50Hz
 Ideal or WAGO UL/CUL approved quick disconnect VDE approved terminal block
 Everlight or Samsung LED Chips

SPECIFICATION

Die casting aluminum lamp body
 backed white coated powder
 High reflectance backed white acrylic paint finished
 High-diffusion light-milky PC diffuser

OPTION

Available for dimmable version
 Available for emergency version
 Available for installing with sensor

APPLICATION

Shop / School / Office / Hotel / Conference Room / Hospital

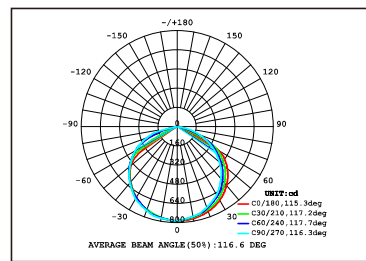
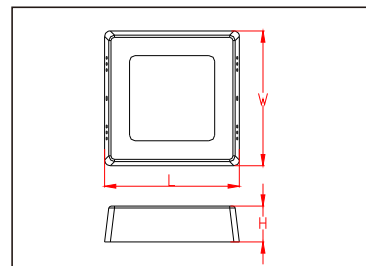

ELECTRICAL COMPONENT

Osram, Philips, Tridonic or meanwell LED driver for 120V-277V/60Hz, 347V/60Hz, 240V/50Hz
 Ideal or WAGO UL/CUL approved quick disconnect VDE approved terminal block
 Everlight or Samsung LED Chips

SPECIFICATION

Die casting aluminum lamp body
 backed white coated powder
 High reflectance backed white acrylic paint finished
 High-diffusion light-milky PC diffuser

OPTION

Available for dimmable version
 Available for emergency version
 Available for installing with sensor

APPLICATION

Shop / School / Office / Hotel / Conference Room / Hospital

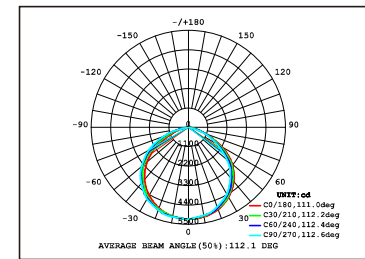
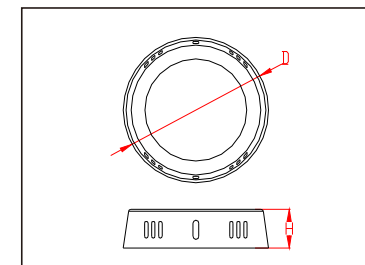

MODEL	WATTS	LUMEN	LED TYPE	LAMP SIZE (L X W X H)	PACKAGE SIZE	PCS/CTN
E2111A-6W	LED 6W	690 LM	SMD2835	121x121x32mm	645x430x140mm	50
E2111A-12W	LED 12W	1380 LM	SMD2835	172x172x32mm	540x430x190mm	30
E2111A-18W	LED 18W	2070 LM	SMD2835	224x224x32mm	475x430x245mm	20
E2111A-24W	LED 24W	2760 LM	SMD2835	300x300x32mm	620x430x320mm	20
E2111A-30W	LED 30W	3450 LM	SMD2835	300x300x32mm	620x430x320mm	20

MODEL	WATTS	LUMEN	LED TYPE	LAMP SIZE (L X W X H)	PACKAGE SIZE	PCS/CTN
E2111B-6W	LED 6W	690 LM	SMD2835	121x121x32mm	645x430x140mm	50
E2111B-12W	LED 12W	1380 LM	SMD2835	172x172x32mm	540x430x190mm	30
E2111B-18W	LED 18W	2070 LM	SMD2835	224x224x32mm	475x430x245mm	20
E2111B-24W	LED 24W	2760 LM	SMD2835	300x300x32mm	620x430x320mm	20
E2111B-30W	LED 30W	3450 LM	SMD2835	300x300x32mm	620x430x320mm	20