



UFO SHB23MP200TC - 100/150/200

Dimmable, IP65 LED UFO highbay with selectable CCT and power.

Application

Super low profile dimmable LED highbay, ideal for commercial or industrial warehouse environments

Design Specifications



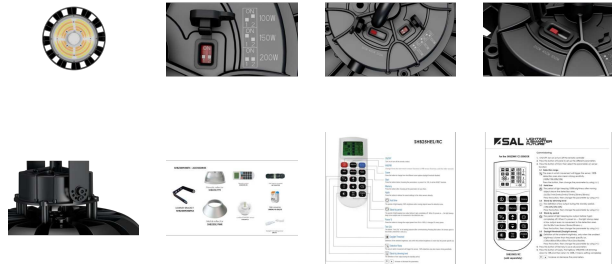



- Integral selectable power 100 / 150 or 200 watts
- Integral selectable CCT 3000, 4000 or 5000K
- Robust, low profile die-cast aluminium IP65/IK08 body profile.
- High efficiency LED optics, with an impressive > 140lm/W optical performance at 150W/4000K, CRI > 80, 90 degree beam distribution, polycarbonate lens
- Integral 1-10V dimmable LED driver, complete with flex and plug for easy installation, optional inline DALI signal converter, optional plug and play corridorSTANDBY sensor
- Power/lumen settings at **3000K** : 100W/13000lm, 150W/18000lm, 200W/22000lm, **4000K** : 100W/14500lm, 150W/21000lm, 200W/26000lm, **5000K** : 100W/14000lm, 150W/19500lm, 200W/24000lm.



Performance

- Dimmable - **YES**
- Dimmer Type - **1-10V, optional SAL DALI signal converter**

Technical Specification

Product	Model No.	Input Voltage (V/AC)	Multiple Wattage	Lumens (lm)	Beam Angle (°)	CCT (K)
	SHB23MP200TC	240	100/150/200	22000/26000/24000	90	3000/4000/5000
	SHB23MP/CS					
	SHB25HES/RC					
	SHB23SE/PPR					
	SHB23MP200PLB					
	LM-DALI010B					

CRI	Body Colour	Diameter (mm)	Dim (mm)	Mass (kg)	IPART
80	BLACK	300	300(W) x 192(H)	2.8	YES
	CORRIDOR SENSOR				N/A
	REMOTE CONTROL				N/A
	PRISMATIC REFLECTOR				N/A
	BLACK				N/A
	DALI SIGNAL CONVERTER				N/A

Note: (1) 1-10V dimming does not provide 100% OFF dimming function.

Note: (2) lumens (lm) shown are displayed at the 200W **maximum power setting**

Note: (3) Sensor default settings: Sensitivity=100%, Hold Time=30mins, StandBy power=30%, StandBy time 30mins, Daylight Threshold=disabled

Note: (4) Sensor and dimming functions cannot be operated simultaneously.

Note: (5) Remote control and sensor function height max 10M.

Due to continued product and technology enhancements, data sourced from sal.net.au shall not form part of any contract and or technical performance guarantee unless expressly confirmed in writing by SAL at the time of order. Products are sold in accordance with [SAL Terms and Conditions of sale](#) and all images shown are for illustration purposes only and may vary from the actual colour or finish. Unless specifically stated, all IP ratings nominated for Interior products are from "below the ceiling".

Dimensions

SHB23MP200TC

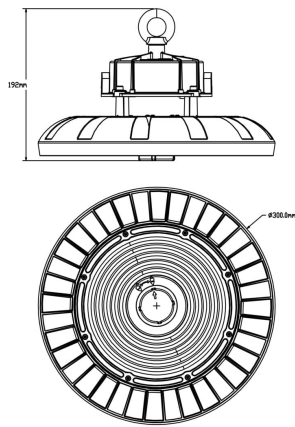

SHB23MP200TC WITH SHB23MP200PLB BRACKET

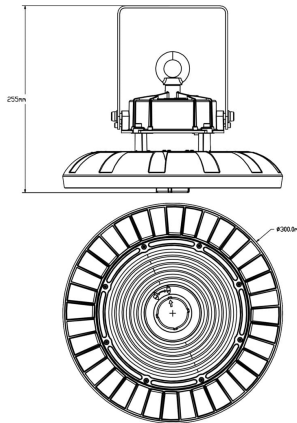

SHB23MP200TC - ACCESSORIES



SHB25HE/RC

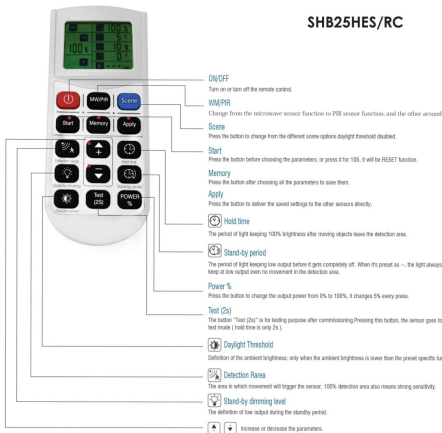

For the SHB25HE series:

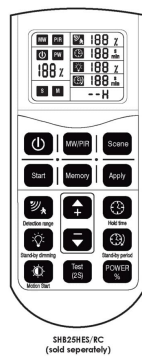

Commissioning (Change the parameter of the sensor on SHB25HE)

1. ON/OFF, turn on or turn off the remote controller
 2. Press the button of Scene to set up the different parameter
 3. Press the button of Start, then select the parameters on sensor function
 - 3.1. **Detection range**
The area in which movement will trigger the sensor. 100% detection area also means strong sensitivity. (100%/75%/50%/25%)
Press the button, then change the parameter by using (+/-)
 - 3.2. **Hold time**
The period of light keeping 100% brightness after moving objects leave the detection area. (5s/10s/15s/20s/25s/30s/35s/40s/45s/50s/55s/60s/65s/70s/75s/80s/85s/90s/95s/100s)
Press the button, then change the parameter by using (+/-)
 - 3.3. **Stand-by dimming level**
The definition of low output during the standby period. (10%/20%/30%/40%)
Press the button, then change the parameter by using (+/-)
 - 3.4. **Stand-by period**
The period of light keeping low output before it gets completely off. When it's powered on, the light always keep of low output even no movement in the detection area. (0s/10s/30s/1min/5min/10min/30min/-)
Press the button, then change the parameter by using (+/-)
 - 3.5. **Daylight threshold (Daylight sensor)**
Definition of the ambient brightness, only when the ambient brightness is lower than the preset specific lux. (120lux/30lux/50lux/30lux/10lux/2lux/0.5lux)
Press the button, then change the parameter by using (+/-)
 4. Press the button of Memory to save all parameters
 5. Press the button of Apply, the Highbay SHB25HE will dimming down to 10% and then return to 100%, it means setting completely
- ▲ ▼ Increase or decrease the parameters.

PMR

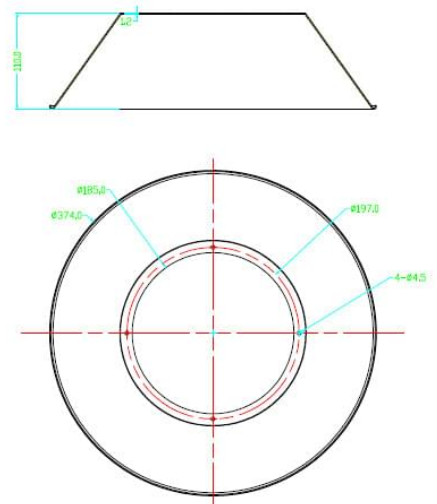

PPR

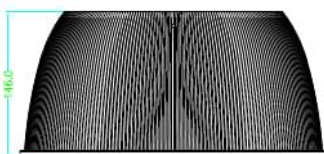
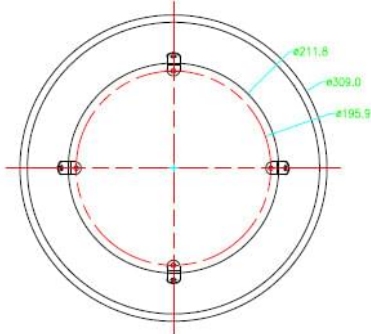

THE NEW ESS106 IS SMALL IN SIZE BUT BIG ON FEATURES.



For more
information
please
scan me

