



## OPAL LGS8TC - 8W

8 watt LED GLS style opal lamps, with selectable CCT

### Application

Energy efficient LED lamp solutions

### Design Specifications

- Opal polycarbonate diffuser, beam distribution 200°
- Poly covered aluminium body, B22 and E27 lamp bases
- High efficiency LED optics, CRI>80
- Integral non-dimmable LED driver
- Selectable CCT 2700K/4000K/6000K
- 1:1 size to traditional GLS / A60 lamp, suits most GLS / A60 lamp fittings, double insulation

### Performance

- Dimmable - **NO**



### Technical Specification

Product	Model No.	Input Voltage (V/AC)	Power (W)	Lumens (lm)	CCT (K)	CRI
	LGS8TC/B22	240	8	700/750/700	2700/4000/6000	80
	LGS8TC/E27	240	8	700/750/700	2700/4000/6000	80



Beam Angle (°)	Dimmable	Diameter (mm)	Length (mm)	Base Type
200	NO	60	112	B22
200	NO	60	112	E27

**IMPORTANT**, where CCT selection switching is provided, it is important to switch OFF the SUPPLY before the CCT selection is made, otherwise equipment damage may occur.

Due to continued product and technology enhancements, data sourced from sal.net.au shall not form part of any contract and or technical performance guarantee unless expressly confirmed in writing by SAL at the time of order. Products are sold in accordance with [SAL Terms and Conditions of sale](#) and all images shown are for illustration purposes only and may vary from the actual colour or finish. Unless specifically stated, all IP ratings nominated for Interior products are from "below the ceiling".

## Dimensions

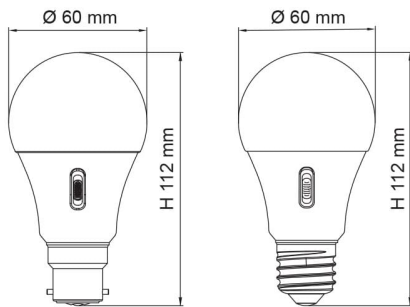

# THE SFI SYSTEM ELIMINATES LED FLICKERING.

**SIMPLY  
MATCH THE  
UNIFIT SFI  
DOWNLIGHT  
WITH THIS  
SDD400SFI  
DIMMER.**



**DIM with  
FLICKER  
CONTROL**

For related  
products  
please  
scan me

