



Network Video Recorder Installation Manual

Supports models from:



NVR-Q41021

Thank you for purchasing this Network Video Recorder.

This install guide covers basic setup, installation and use of your surveillance system.

For detailed technical support and software downloads, visit our Help Centre at: help.c5k.info

Note: *This guide references the latest version of the NVR firmware (as of Q4 2021). Some images and instructions may differ depending on firmware version.*



help.c5k.info

Software utilised in this manual was current at the time of manual creation.

For the latest version of surveillance software for PC and Mac systems, please scan the QR code or follow the link to the right.

A brief overview of key software is listed below:

SmartPSS: Remote view application for live view, playback and configuration of your surveillance system. For Windows & Mac PCs.

Smart Player: Playback exported footage & convert video files for Windows & Mac PCs.

DMSS: Mobile surveillance application for iOS & Android

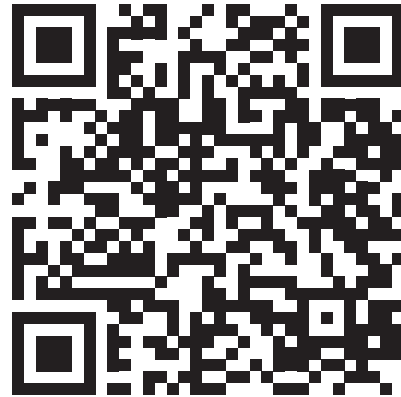

Scan QR code or navigate to: help.c5k.info/software/software-downloads

Table of Contents

1. Pre-Installation	4
1.1 Pre-Installation Safety Information	4
1.2 Connecting your NVR and Cameras	4
1.3 NVR Rear Panel & Setup Diagram	5
2. Installing Cameras	6
2.1 Maximising Camera Effectiveness	6
2.2 Mounting Surveillance Cameras	6
3. NVR and Camera Configuration	8
3.1 First Boot and Startup Wizard	8
3.2 Configuring Surveillance Cameras	13
3.3 Configuring Storage Settings	14
3.4 Display Settings	17
4. Footage Playback	18
4.1 Accessing Stored Footage	18
5. Footage Backup & Viewing	20
5.1 Backup Footage to USB	20
5.2 Viewing Footage on a Computer	21
6. Intelligent Functions	23
6.1 Mounting Surveillance Cameras for AI Functions	23
6.2 AI Live View	26
6.3 Motion Detection	27
6.4 Tripwire & IVS Setup	28
7. AI Face Detection	29
7.1 Face Detection & Recognition	29
7.2 Adding Faces to the Face Library	31
7.3 AI Trigger Actions	32
8. Smart Search	33
8.1 Face / Vehicle / Non-Motor Vehicle / Human Body Detection	33
8.2 Face Recognition Smart Search	34
9. Troubleshooting	35

1. Pre-Installation

1.1 Pre-Installation Safety Information

Before connecting your NVR (network video recorder) or cameras, please ensure the following safe installation guidelines are adhered to.

- Do not place cords from the NVR where they can be pinched or stepped on.
- Do not place heavy objects on cords, or cover cords with rugs or carpet.
- Do not expose the NVR to excessive heat or moisture.
- Leave at least 50mm of space between the NVR and other objects to allow ample air circulation.
- Never immerse any component in water and do not spray cleaners or solvents on the cameras.
- Shut down and unplug the recorder before cleaning. When cleaning, use a damp, lint-free cloth only.
- Service of your NVR or surveillance cameras should only be handled by qualified technicians.

We recommend only using **Surveillance-grade HDDs** with your NVR, such as Seagate Skyhawk or WD Purple. These HDDs are built to handle the heavy workload of 24/7 recording; standard HDDs may encounter performance issues.

1.2 Connecting your NVR and Cameras

The following section will detail connecting the NVR and surveillance cameras. It is recommended that cameras and connections are tested before mounting. If there is no image, an error message or dark screen when first connecting cameras, see **Troubleshooting** in Section 8 in this guide.

Refer to **1.3 NVR Rear Panel & Setup Diagram** for full NVR & system diagrams. Refer to rear panel diagram **Fig 1.1** or your NVRs diagram/dimensions for input and output locations.

1. **Connect the cameras to the NVR:** Using CAT5e/CAT6 LAN cables, connect cameras to the built-in PoE Ports on the back of the NVR. No additional power is required for the cameras.
2. **Connect network switches to the NVR:** Connect any network switches to the LAN ports on the back of the NVR.
NOTE: *Connect to a LAN (Ethernet) port, NOT a PoE port.*
3. **Connect a display:** Using an HDMI or VGA cable, connect a monitor or television (not included).
4. **Connect the mouse:** Connect the USB mouse to the rear USB port, saving the front port for easy USB backup.
5. **Connect to your local network:** Using the included Ethernet patch cable, connect to your switch or router.
6. **Connect NVR power:** Plug in the supplied AC power cord to the rear of the NVR.

Upon activating power, LED lights at the front of the NVR should turn on and the NVR will sound on startup. The NVR will then run your surveillance user interface. Cameras will be detected automatically. This completes a successful first boot of your surveillance system and you may begin configuring surveillance cameras.

1.3 NVR Rear Panel & Setup Diagram

NOTE: Your NVR (network video recorder) model may differ - a 16 channel NVR is shown below.

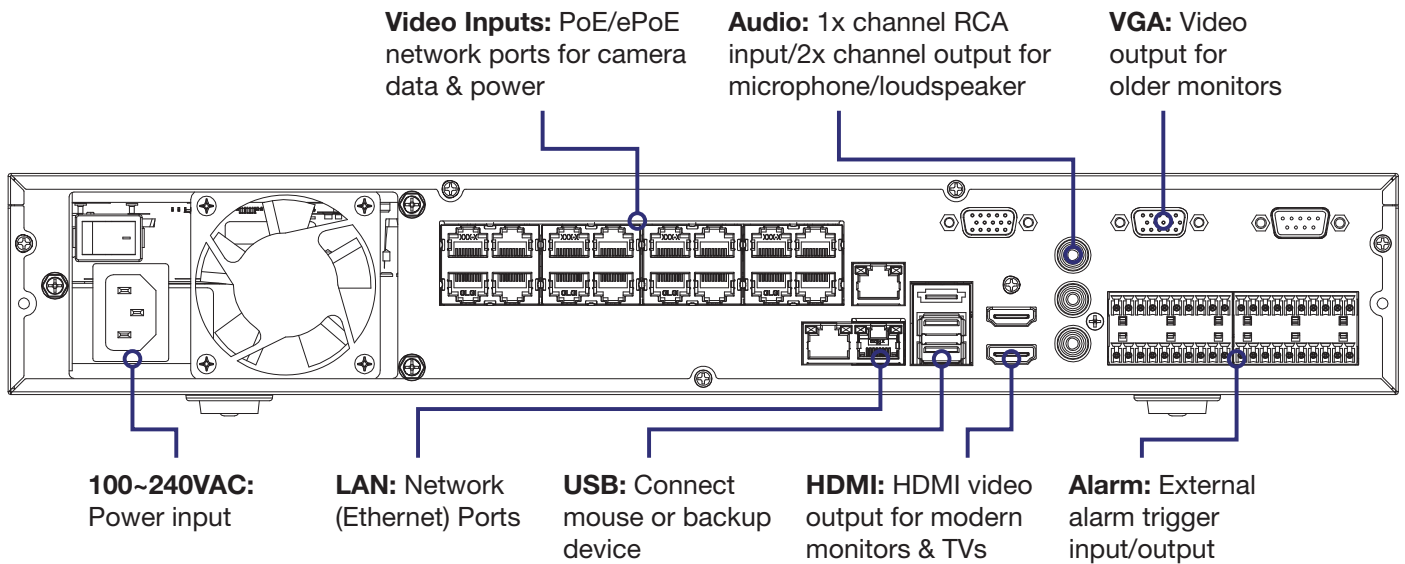

Fig. 1.1: NVR Rear Panel Diagram

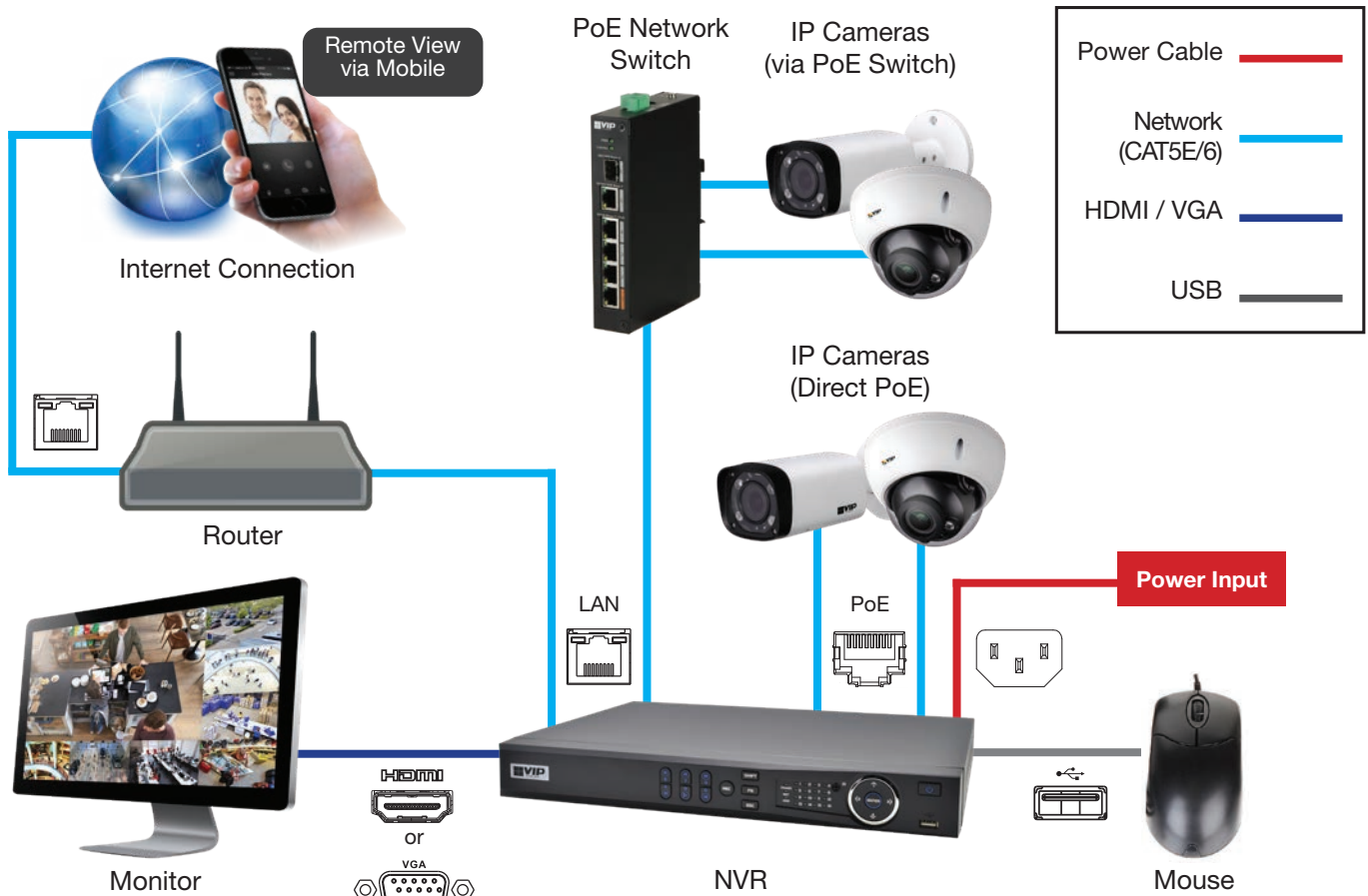

Fig. 1.2: System Setup Example

2. Installing Cameras

2.1 Maximising Camera Effectiveness

To maximise the effectiveness of your surveillance cameras, follow these guidelines for camera mounting.

- **Avoid pointing cameras directly in front of large objects, including walls & eaves.** When infrared turns on at night or in low-light, it may be reflected back into the camera, resulting in an over-bright image.
- Avoid pointing cameras directly at light sources.
- Consider how the sunlight changes during the day. Mount your camera where sunlight has minimum impact.
- Consider your local and state laws before installing your cameras. This may affect where you point your surveillance cameras.
- Avoid direct exposure to weather. If possible, mount under an eave or awning. While the cameras are water-resistant, rain on the lens will affect image quality.
- Ensure the mounting surface thickness can support triple the weight of the camera.
- Do not mount the camera behind glass as this can reduce performance and usability of surveillance in both day & night images.
- Light levels should be approximately the same between the camera and the targeted area.
- Do not place camera or cabling near high voltage wires or other sources of electrical interference.

2.2 Mounting Surveillance Cameras

1. Loosen the camera mount assembly by adjusting the locking screw with the included wrench.
2. Mark the screw position on the mounting surface.
3. Drill mounting holes for the wall plugs.
4. Drill a larger hole (approx. Ø10mm) so the camera cable can pass through the mounting surface.
5. Pull the cables through the building walls/ceiling from the camera to the recorder.
6. Connect the camera LAN cables, ensuring your camera is sealed away from rain and dust. If installing in an area where moisture exposure is possible, seal power and video connections with self-amalgamating tape (not included).
7. Affix the camera to the mounting surface using the supplied screws and wall plugs.
8. Reassemble the camera, loosely locking the enclosure using the locking screw and wrench.
9. Connect the LAN cable back to the NVR and view the video feed.
10. Adjust your camera to the desired position.
11. Tighten the locking screw(s) to complete mounting.

NOTE: To adjust the angle of cameras with tri-axis mounting, simply loosen the locking screw(s) to adjust your camera's position, then tighten again once finished.

2.2 Mounting Surveillance Cameras (cont.)

NOTE: Diagrams shown below assume camera to be mounted on masonry. Cameras mounted on drywall (gyprock, plasterboard, etc.) will require special mounting screws or toggles (not included).

Diagrams are examples only - screws and other physical components may vary depending on your camera model(s).

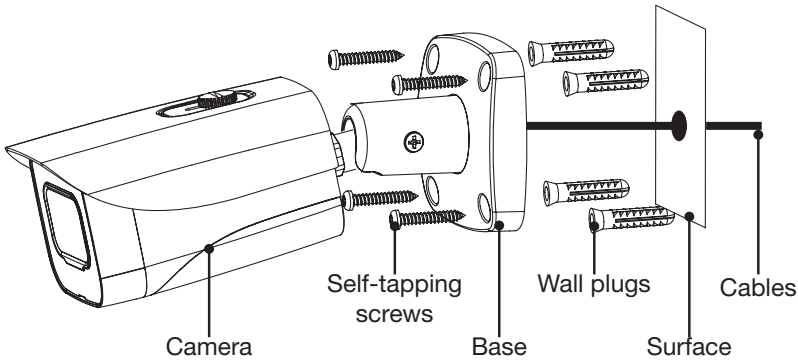

Fig. 2.1: Mounting diagram for fixed bullet

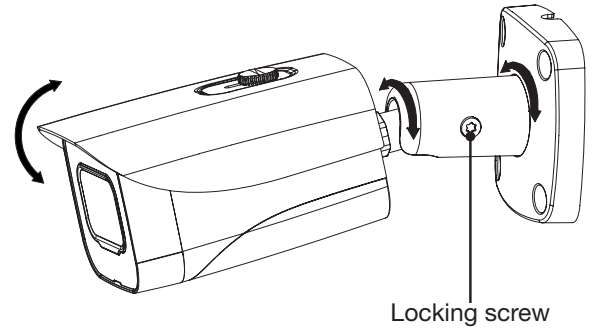

Fig. 2.2: Tri-axis fixed bullet adjustment

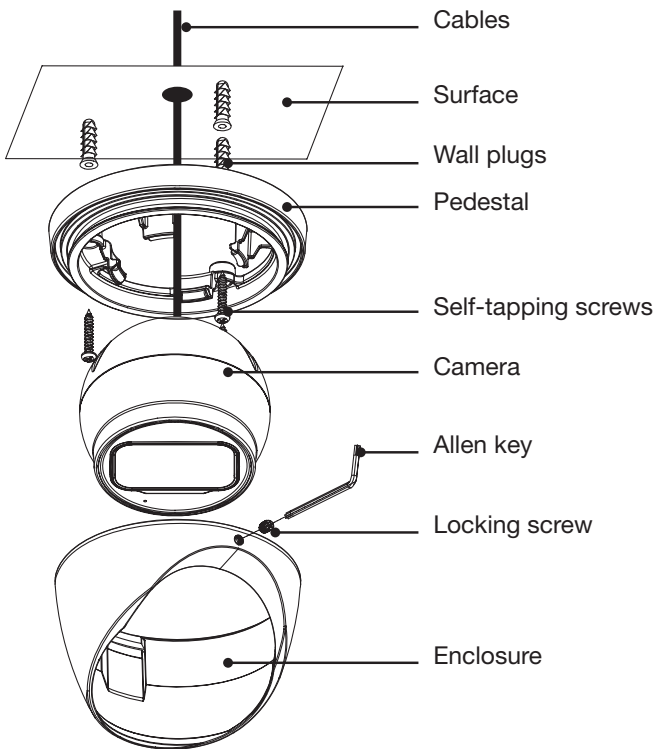

Fig. 2.3: Mounting diagram for fixed dome

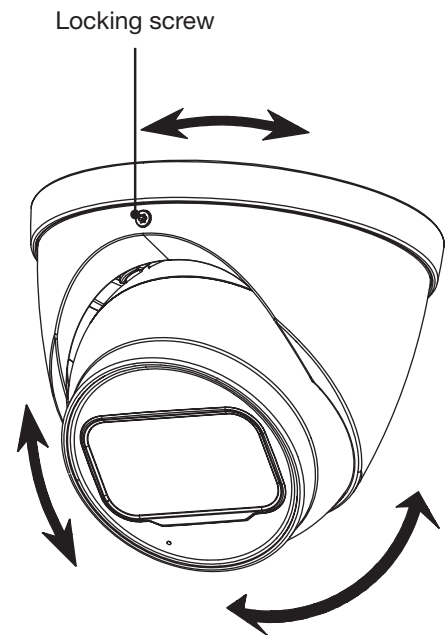

Fig. 2.4: Tri-axis fixed dome adjustment

3. NVR and Camera Configuration

3.1 First Boot and Startup Wizard

After successful connection and boot of your NVR, you will be taken through first-time setup for your surveillance system. Here you will configure system security and begin customising your NVR, including setting camera encoding options, record scheduling, network setup and remote view configuration. **USB keyboards are supported, but not required**; an on-screen keyboard will appear when needed.

NOTE: Each setting shown in the Startup Wizard can be modified later via the NVR Main Menu. See the Menu Quick Guide in Section 6 or see the full user manual for more information.

Following the prompts, complete each section in the Startup Wizard, as detailed below:

3.1.1 Startup Wizard

When the NVR is powered up for the first time or the NVR is restored to factory settings, the Startup Wizard will be displayed. Users can set common NVR functions by following the procedures step-by-step

3.1.2 Device Initialization

The first step of the Startup Wizard is Device Initialization. Here you can confirm the basic settings of your NVR such as region, video standard, language, date, time and automatic updates.

Default settings are adequate to get started, we recommend checking the following:

1. Set your **Region, Time Zone** and **System Time**.
2. Users in NSW, VIC, SA, TAS and ACT will need to enable **DST** (Daylight Saving Time). Adjust **Start Time & End Time** settings.
3. Enable the **Online Update** setting to be notified whenever a new firmware update is available. For compatibility with future cameras and to receive security updates, we recommend this setting to be turned on.

NOTE: Daylight Saving Time begins at 2am on the first Sunday in October, when clocks are put forward one hour. It ends at 2am (which is 3am Daylight Saving Time) on the first Sunday in April, when clocks are put back one hour.

NOTE: **Online Updates** requires an internet connection.

The screenshot shows the 'Device Initialization' screen with the following settings:

Region	Australia
Language	English
Video Standard	PAL
Time Zone	(UTC+10:00) Canberra, Melbourne, Sydney
System Time	2021 -08 -30 13 : 27 : 50
DST	<input checked="" type="checkbox"/>
Type	<input type="radio"/> Date <input checked="" type="radio"/> Week
Start Time	Oct 1st Sun 02:00
End Time	Apr 1st Sun 03:00
Online Update	<input checked="" type="checkbox"/>

Fig. 3.1: Device Initialization Screen

3.1 First Boot and Startup Wizard (continued)

3.1.3 Securing your NVR

In the Startup Wizard, you will be prompted the setup the **admin account**.

1. Enter a strong **password** to be used for the **admin** account. It is recommended to use a combination of letters, numbers and symbols.
2. (Recommended) Enter a **Password Hint**.
3. Click **Next**.
4. (Optional) Draw an **Unlock Pattern** for quick unlocking or click **Skip**.
5. (Recommended) Enter an **Email Address** to be used for password resets.
6. (Recommended) Select three **Security Questions**, then enter the three Answers. This will be used if the admin password is forgotten. Please note that answers are **case-sensitive**.

NOTE: Email address password resets require a mobile phone with the DMSS app & internet access.

NOTE: We strongly recommend setting up email password reset and security questions. If the password is forgotten and no recovery method is set up, the recorder will need to be sent back to the supplier for a system reset, which will incur a fee even if the system is still within the warranty period.

3.1.4 Configuring TCP/IP, P2P, and Remote View

Network setup will be prompted next, enabling you to connect your DVR to the Internet. First ensure that your DVR is connected to your switch or router via the included CAT5 cable (detailed in Section 1.3). For the simplest setup we recommend using DHCP to connect to the Internet. You will then be prompted to configure P2P for remote view on your internet connected phone or tablet.

1. In the **Network** section, select **modify**  next to **nic1**.
2. Turn on **DHCP**, then click **OK**.
3. Click **Next** to continue.
4. Enable **P2P** to enable remote access.
5. **P2P Status** should read **Online**. This indicates an active internet connection. (This may take a few minutes).

Fig. 3.2: Password Setting screen

Fig. 3.3: Unlock Pattern screen

Fig. 3.4: Password Protection screen

Fig. 3.5: NIC1 Modify Page (example only)

Fig. 3.6: P2P Setup Page (example only)

3.1 First Boot and Startup Wizard (cont.)

Remote View: Adding NVR via QR Code

The following details remote view configuration via the **DMSS app** (Apple iOS / Android) on your device. Depending on the device or app version, menus may function or appear slightly different to those explained below.

1. Go to the **Home** screen.
2. To add your NVR by QR Code, select the **+** **Button** and then select **SN/Scan**.
3. Scan the **Device SN** QR code that you see in the P2P section (Fig. 3.5).
4. Optionally, select **Manually Enter SN** to type in the device SN (serial number) to manually add device.
5. Select the **Device Type** as NVR.
6. Choose a name for your NVR in **Device Name**.
7. Enter the **Username** and **Password** for your NVR. The default username is **admin** and the password is what was set in **Section 3.1.3**
8. Tap **Save**.

Remote View: Enabling Push Notifications

After adding your Recorder to your iOS / Android device, the next step is to enable notifications. This will allow you to receive & respond to surveillance app alerts on your device.

1. Go to the **Home** screen.
2. Select the **...** **Button** on the device to add push notifications for.
3. Select **Device Details**.
4. Tap on **Notification** or **Multi-channel Alarm Subscription**.
5. Toggle Alarm Notifications to **ON (blue)**.
6. Tap on the notifications you wish to receive and enable them. E.g. To enable notifications for Low HDD Space: Tap Disk Alarm, then enable Low Space.
7. Tap **Save**.

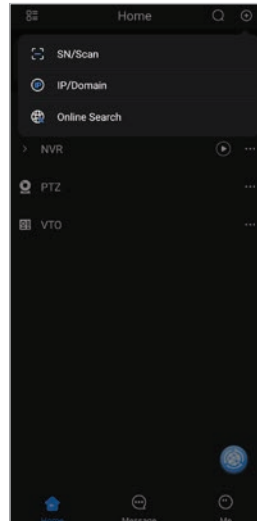

Fig. 3.7a: Home Screen

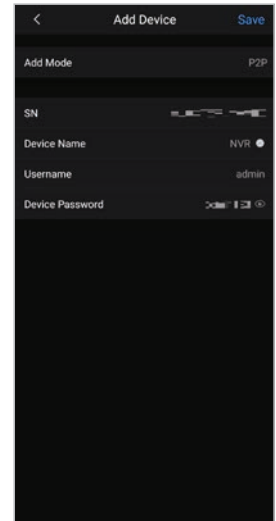

Fig. 3.7b: QR Scan

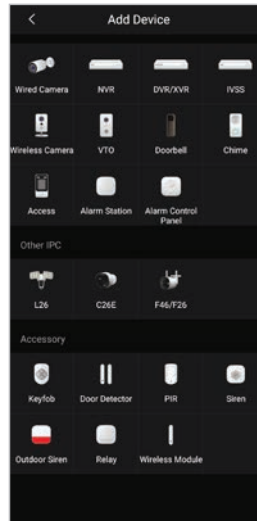

Fig. 3.7c: Manual S/N



Fig. 3.7d: Add Device

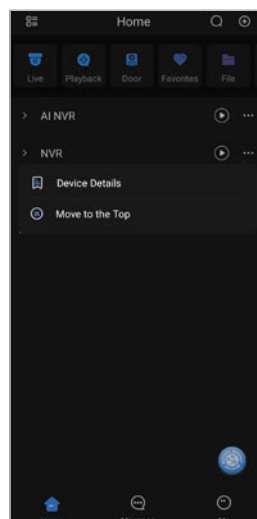

Fig. 3.7e: Device Details

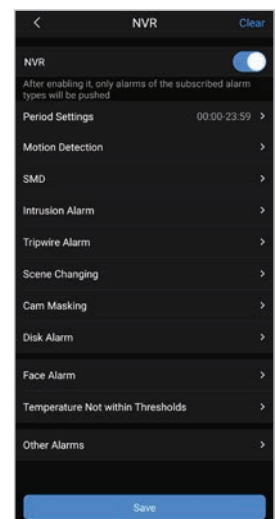

Fig. 3.7f: Alarm Notification

3.1 First Boot and Startup Wizard (cont.)

3.1.5 Configuring Surveillance Cameras

After configuring remote view, the Startup Wizard will take you to the Camera List menu. This menu will display all detected cameras. Users can also add cameras manually. Cameras that are connected will automatically be displayed.

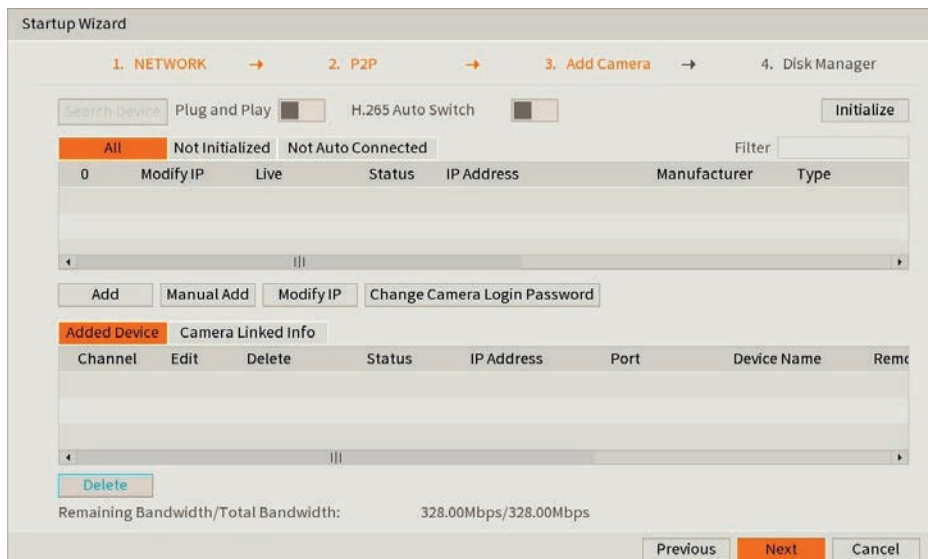

Fig. 3.8: Add Camera Setup page

Device search: Search all network cameras in the same network segment. To add a camera, double click on the camera list or check the box then click Add button.

Initialize: Used to configure manually added cameras.

Channel: The camera's channel number.

Status: Camera connection status. **Red circle** = camera is offline. **Green circle** = camera is online.

IP Address: Network camera's IP address.

Port: The port number of the network camera.

Manually add Camera with Known IP Address and Password

1. Click the **Manual Add** Button
2. Set **Manufacturer** to Private (If the camera is a 3rd party camera select ONVIF).
3. Enter the **IP Address**, **Username** and **Password**.
4. Click **OK** to add the camera.

Initialising and Manually Addressing Cameras over Network

1. Select **Device Search**.
2. Tick every camera that you wish to initialise, then click the **Initialize** button.
3. You will be brought to an **Enter Password** screen. Tick **Using current device password and email info**, then click **Next**.
4. Enter the **IP Address**, **Subnet Mask** and **Default Gateway**, then click Next. (NOTE: When initialising more than one camera, the last section of the IP address will be incremented by the Incremental Value.
5. Click **Finished** once all of the cameras have been initialised and addressed.
6. Click **Device Search**.
7. Tick the **checkbox** next to the newly initialised & addressed camera, then click the **Add** button.

3.1 First Boot and Startup Wizard (cont.)

3.1.6 HDD Formatting

If your recorder is fitted with a HDD, ensure it is listed on screen, and the health status is normal. Select OK to finish the setup wizard.

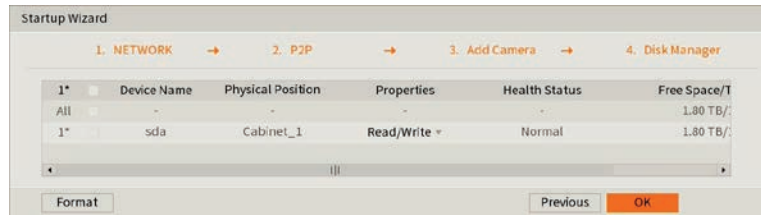

Fig. 3.9: Add Camera Setup page

3.1 First Boot and Startup Wizard (cont.)

3.1.7 Completed Setup

Startup setup is complete. Below is an example of a **View 8 Liveview** setup. Before mounting cameras, familiarise yourself with the user interface and menu layout.

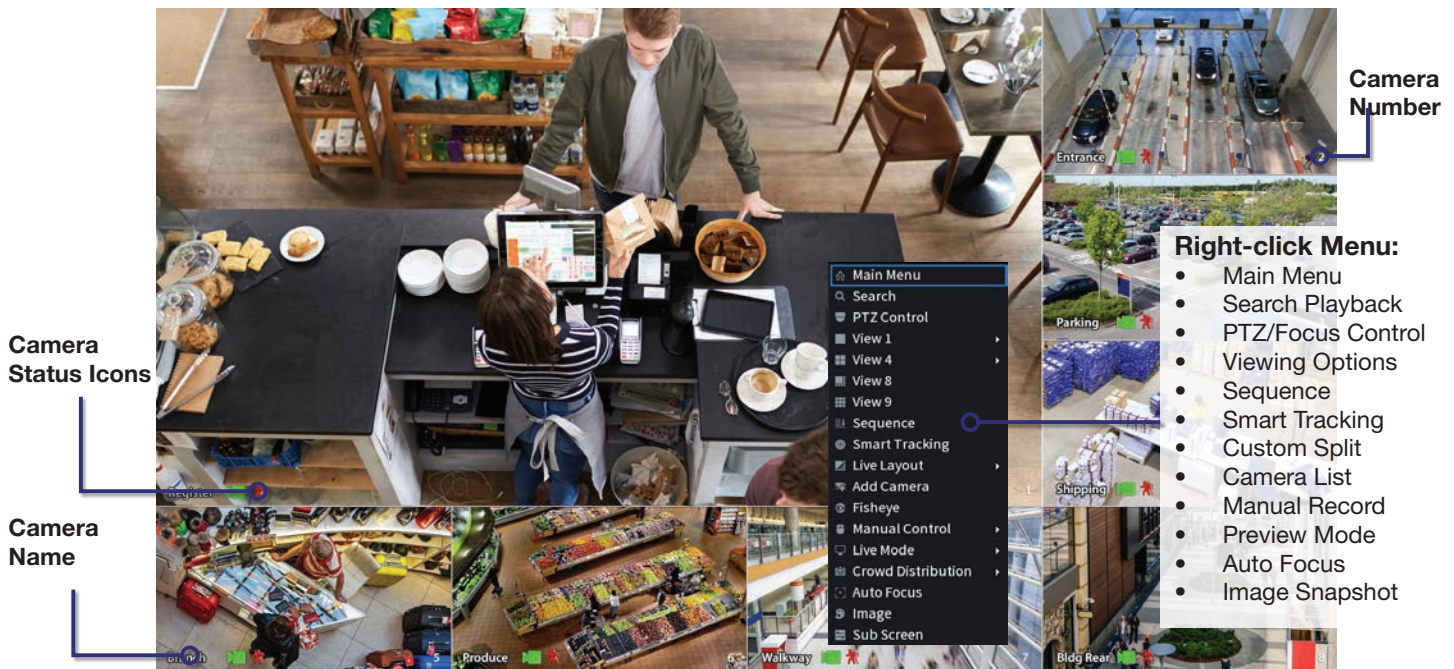

Fig. 3.10 View 8 Liveview screen with right-click menu open.

Liveview Controls

- **Double-click** on a camera window to make it full-screen; double-click again to return to normal view.
- **Right-click** to access the right-click menu.
- From the right-click menu, click **Main Menu** to access most configuration settings.

Main Menu Controls

- **Mouse wheel scroll** to view more menu options.
- **Left-click** to enter a menu.
- **Right-click** to return to the Main Menu / return to the Liveview screen from the Main Menu.

3.2 Configuring Surveillance Cameras

3.2.1 Camera Quality & Bit Rate

After the Startup Wizard has been completed, you can make adjustments to the camera settings via the **Encode** menu. From the **Main Menu** go to the **Management** section at the bottom and click **Camera**.

Each camera features a **Main Stream** for high quality streaming to the NVR; and a **Sub Stream** for low quality, low data streaming to your remote view phone or tablet. You can configure both of these streams for **each individual camera**, so you can choose to prioritise quality for important cameras and recording time for others.

- For each camera channel set the desired encoding options. Refer to Fig 3.11, Fig 3.12 and the settings detailed below.
- If the camera has a built-in microphone, select **More**, then enable **Audio**.

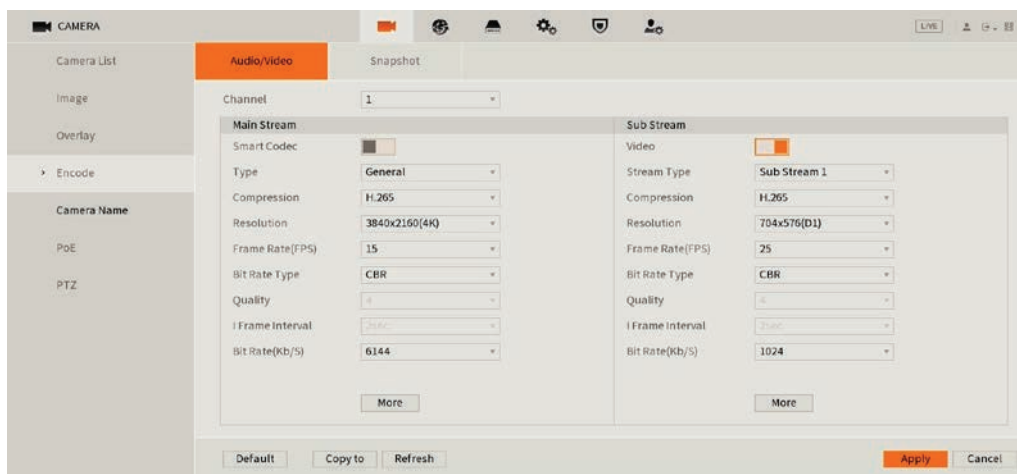

Fig. 3.11: Example encode settings for channel 1
(Quality Optimised 8MP, H.265 system)

Encode Setting Explained

Type: This dropdown menu switches between encode settings for General, Motion and Alarm recording. Different encode settings can be separately set for each type of recording mode (Standard camera streams will use General settings, while camera streams with Motion Detection enabled will use Motion settings).

Bit rate: The rate at which video data travels from the camera to the recorder, measured in Kilobits per second. This directly determines the quality of the video stream and how much capacity footage will occupy on the hard drive. *It is recommended to leave this as the **default** value for **optimised quality**, or **2048** for **optimised recording time**.*

Bit Rate Type: How bit rate is controlled. By setting **CBR (constant bit rate)**, the camera bit rate is pre-defined and camera quality is constant no matter what is being captured. By setting **VBR (variable bit rate)**, the camera uses a low bit rate when there is little scene activity and switches to a high bit rate when there is more activity. CBR ensures constant quality, whilst VBR conserves hard drive capacity in times of low activity. *It is recommended to set this to **CBR** for **optimised quality**, or **VBR** for **optimised recording time**.*

Compression: The compression technology used when encoding footage for storage on a hard drive. H.265 is the most efficient at compressing footage for storage on your hard drive and will provide the most total record time. ***H.265** is recommended for **Main Stream**, **H.264** for **Sub Stream**.*

Resolution: The camera's image resolution; dictates the size of captured images. A high set resolution means larger pictures captured by the camera each frame, which means higher required bit rate & hard drive storage capacity. *It is recommended to set the **Resolution** as the **highest value** for **Main Stream** and **D1** for **Sub Stream**.*

Frame Rate (FPS): Frames per second, or, the number of images that make up each second of video captured by the camera. A high frame rate means more data per second is captured by the camera and sent to the recorder, this requires a higher set bit rate & hard drive storage capacity.

3.2 Configuring Surveillance Cameras (cont.)

Optimised Encode Settings

Fig. 3.12 details quality optimised values and max. recording-time optimised values for 4K cameras. Values will vary by camera model.

Field	Quality Optimised		Recording Time Optimised	
	Main Stream	Sub Stream	Main Stream	Sub Stream
Resolution	3840 * 2160	720 * 576	3840 * 2160	720 * 576
Frame Rate	15fps	15fps	15fps	15fps
Bit Rate Type	CBR	CBR	VBR	VBR
Bit Rate	6144Kbps	1024Kbps	2048Kbps	512Kbps

Fig. 3.12: Suggested camera encode values to be set for 8MP cameras.

3.3 Configuring Storage Settings

3.3.1 Configuring Basic Storage Settings

Here, you can configure the settings for situations when the HDD is full, file size/time length of recorded video, and the settings for auto-deleting old files.

To configure basic storage settings, from the **Main Menu** select **Management-Storage**, then select the **Basic** tab.

- **Disk Full:** Configure the settings for when all the read/write discs are full, and there is no more free disc.
- **Create Video Files:** Configure the time length and file length for each recorded video.
- **Delete Expired Files:** Configure whether to delete the old files or not. If yes, also determines how many days of footage are deleted.

Click **Apply** to save settings

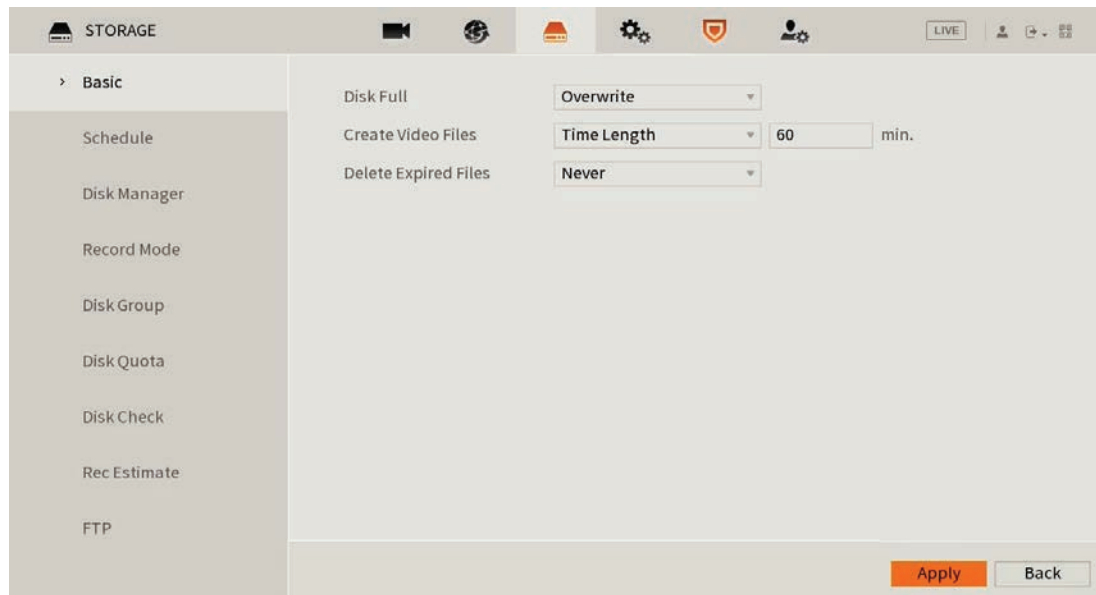

Fig. 3.13: Storage Settings

3.3 Configuring Storage Settings (cont.)

3.4.2 Configuring Recording Schedules

Here you can define the recorded footage schedule in the Record menu (Fig. 3.15), and the recorded image snapshot schedule in the Snapshot menu. By default, cameras are set to non-stop General recording (24 hours a day, 7 days a week).

Schedules can be set in hourly periods for individual days for each camera, with colour-coded options for:

- **General (green)** for all regular recording.
- **Motion (yellow)** for recording on motion detection.
- **Alarm (red)** for recording on triggering an integrated alarm.
- **M&A (orange)** for simultaneous alarm/motion detection recording.
- **Intelligent (blue)** for recording on triggering IVS (Intelligent Video Surveillance) such as a virtual tripwire.
- **POS (violet)** for point of sale transactions.

We recommend adding motion detection and intelligent recording to all channels to accompany your regular recording.

The screenshot shows the 'STORAGE' configuration page with the 'Record' tab selected. The 'Schedule' section is active, displaying a grid for configuring recording schedules for each day of the week (Sun through Sat). The grid has columns for hours from 0 to 24. A legend at the top indicates recording modes: General (green), Motion (yellow), Alarm (red), M&A (orange), Intelligent (blue), and POS (violet). In the screenshot, the 'General' mode is selected for all hours of all days. The 'Pre-Record' is set to 4 seconds and 'Redundancy' is set to ANR 1800 seconds. The 'Default' button is visible at the bottom left, and 'Apply' and 'Back' buttons are at the bottom right.

Fig. 3.14: Recording Schedule with General, Motion & Intelligent recording set to a 24/7 schedule

3.3 Configuring Storage Settings (cont.)

Setting Motion Detection & Intelligent Recording

1. Click the **Channel** drop down to select **All** cameras.
2. In the days column, toggle the **All** check box to simultaneously set recording schedule parameters for every day of the week.
3. Check the yellow **Motion** check box to select motion detection recording.
4. Click the schedule to fill in areas for motion detection recording. We recommend a 24/7 schedule to mirror your Regular recording schedule (Fig. 2.10).
5. Repeat steps 3 & 4 with the blue **Intelligent** check box to set intelligent recording (tripwire, face detection, etc).
6. Click **Apply** to confirm recording schedule changes.

Setting Snapshot Schedule

The **Snapshot Storage Schedule** is configured similarly to the Recording Schedule. For consistency between recording and snapshots, we recommend using the **same settings used for the Recording Schedule**.

You have now set up motion detection & intelligent recording. This will be beneficial when it comes to searching footage in playback (Section 4.0). This can be edited any time from **Main Menu -> Management-Storage -> Schedule**.

Note: For instructions on how to configure MD / IVS etc., see [6.3 Motion Detection](#) & [6.4 Tripwire & IVS Setup](#).

The screenshot displays the 'Snapshot' configuration page in a web interface. The left sidebar contains navigation options: Basic, Schedule, Disk Manager, Record Mode, Disk Group, Disk Quota, Disk Check, Rec Estimate, and FTP. The main area is titled 'Snapshot' and shows a 24-hour timeline for each day of the week (Sun-Sat). The timeline is divided into 2-hour segments. The recording schedule is set to 24/7 for all days. The legend indicates that General (green), Motion (yellow), and Intelligent (blue) recording are all enabled. The 'Channel' is set to 'All'. The 'Apply' button is highlighted in orange.

Fig. 3.15: Snapshot Schedule with General, Motion & Intelligent recording set to a 24/7 schedule

3.4 Display Settings

3.4.1 Configuring Display Settings

To configure display settings, navigate to **Main Menu** -> **Display**. You may have to scroll to the second page of the Main menu.

- Set the **Resolution** to the resolution of your monitor or television. Be careful not to set this value higher than what your TV/monitor can support or it will be unable to display the NVR.

Configuring a Second Display

You can configure the VGA or a second HDMI port to display different cameras to the HDMI port.

1. Enable **Sub Screen**.
2. Set the **Output Port**. For NVRs with two HDMI Ports, set this to HDMI 2. For NVRs with one HDMI, set this to VGA.
3. Set the **Resolution**.
4. Click **Apply**.
5. Exit the **Main Menu**, right-click, then select **Sub Port**.
6. The mouse will move to the other display. Click **OK** on the prompt.
7. **Right-click** then select the **View** you wish to use.
8. Select **Main Port** to return to the Main Screen, then Click **OK** on the prompt.

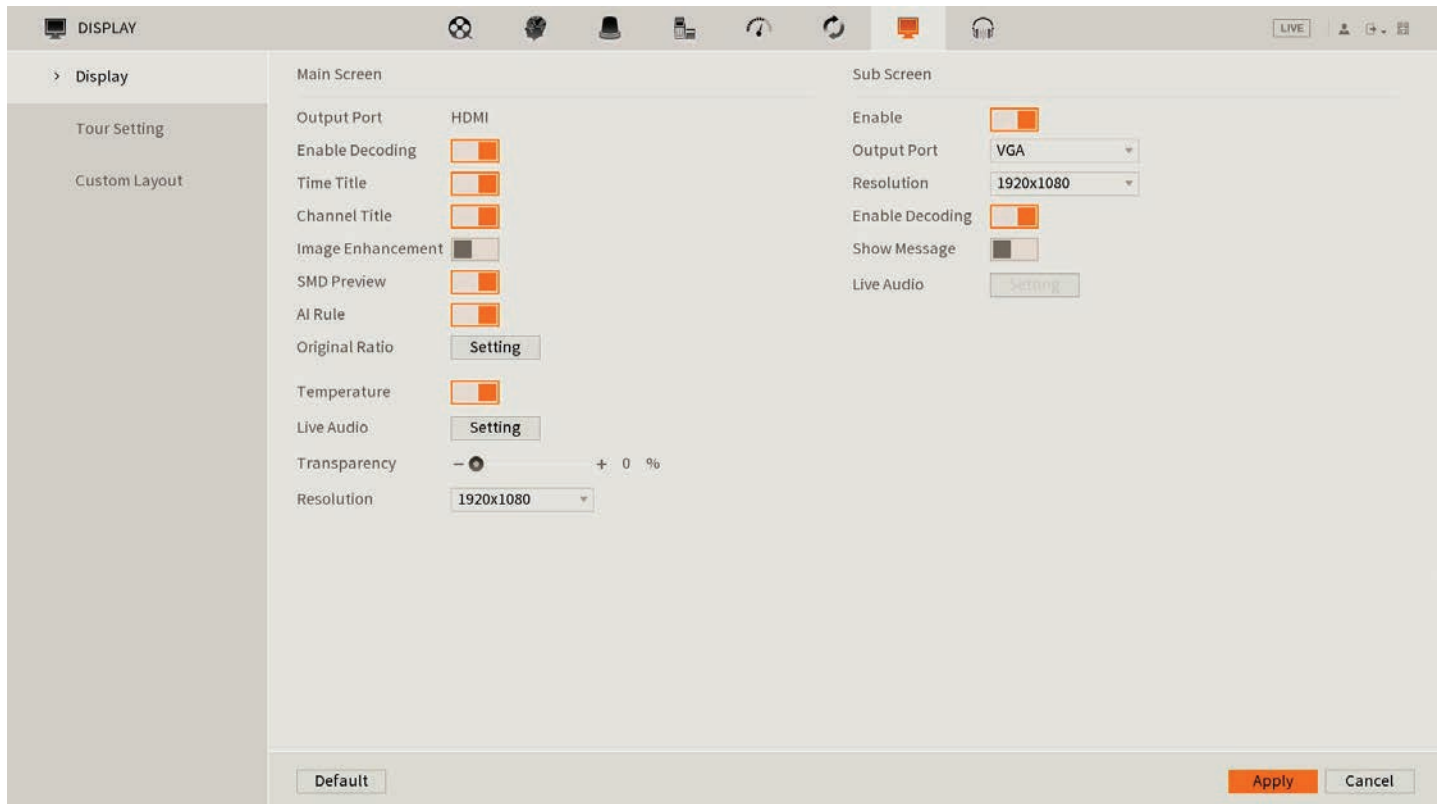

Fig. 3.16: Configuring Display Settings

4. Footage Playback

4.1 Accessing Stored Footage

To access footage playback, select the **Search** button from the **Main Menu**. Stored footage can be accessed by searching by date and refined by footage type (General, Motion, Alarm, etc). The below image details the playback interface with footage selected.

After locating the desired footage, you can immediately backup the video by using the search menu. See Section 5.1.1 for more information.

4.1.1 Playback Footage by Date

Use Fig. 4.2 on the opposite page as a guide.

1. Ensure that the correct **HDD** is selected and that **REC** checked in **Source Select**.
2. Using the **Date Select** calendar, choose your date for footage playback. A coloured dot icon indicates stored footage is available for that day (Fig. 4.1).

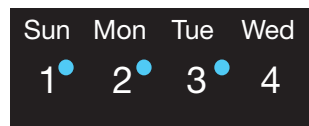



Fig. 4.1: Date select Calendar showing footage is available for Sun, Mon, Tue.

3. Select the cameras to be viewed. The screen will automatically split depending on the amount of cameras selected.
4. The **Footage Timeline** should populate with stored footage, indicated by coloured bars in the timeline. Click anywhere on the timeline to begin footage playback. Other cameras will automatically sync their playback to the selected camera.
5. For greater precision playback control, zoom in on areas using the **Timeline Zoom**, up to 30 minutes.
6. Using the **Playback Controls**, you can speed up or slow down playback, place marks on key footage times and take snapshots.

4.1.2 Playback Footage by Smart Search

NOTE: Smart search requires motion detection to be recorded to function. You can only Smart Search playback footage one camera at a time. If Smart Search is not functioning, check Section 6 for troubleshooting.

1. As detailed in the previous section, use **Date Select** to locate your desired date for footage playback, and choose a single camera only in **View Select**.
2. Click anywhere on the Footage Timeline to begin playback. Then select the **Smart Search** button .
3. A grid will appear overlaid onto your camera playback. Highlight an area of interest on the grid. This will define the motion detection area that is used by Smart Search.
4. Select the **Smart Search** button again to begin playback of all motion detected events in the area you selected.

By configuring your recording schedule for motion detection and by using Smart Search, you can quickly find the footage you require. For **Footage Backup**, proceed to Section 5.



Fig. 4.2: Four camera view simultaneous footage playback.

5. Footage Backup & Viewing

5.1 Backup Footage to USB

Should you wish to preserve recorded footage before it is overwritten, you will need to perform a footage backup. Footage can be exported from your NVR in a **.DAV** or **.MP4** file. A **.DAV** file will require conversion for sharing, whereas an **.MP4** file is compatible with most video players on Windows or Mac PCs. Each file type is covered in Section 5.2.



There are two different ways to backup footage to USB: via the **Search** menu through searching playback footage; and by performing a direct backup via the **Backup** menu. Both are accessed via the **Main Menu**.

File selection (**.DAV/.MP4**) is only available in the **Backup** menu. Backup in **Search** Menu outputs **.DAV** files only.

Note: When backing up footage to an external HDD, it will first need to be formatted by selecting the **“Format”** button. **This will clear all data on the external HDD.**

5.1.1 Backup Footage via Search Menu

Using the **Search Menu**, find start/end points of backup footage by using playback video as a reference.

1. As detailed in Section 4, locate the footage you wish to backup. Select the desired camera in single view mode.
2. Using the **Footage Timeline**, click the approximate desired time for your backup video start point. Selecting the **Clip Button**  on the **Backup Controls** (Fig. 5.1), this will set your start point.
3. Again, using the **Footage Timeline**, click the approximate desired time for your backup video end point. Select the **Clip Button** again to set your end point.
4. Select the **Save Button**  to open the **Backup** menu.
5. This process can be repeated to add more clips from different channels.
6. Plug in your USB device, exiting any automated prompts, and select **Backup** to begin backup.

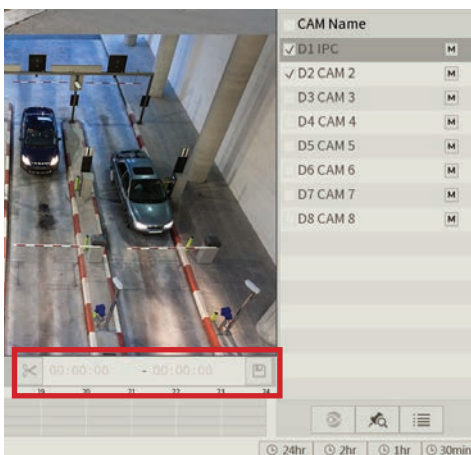

Fig. 5.1: Backup Controls in Search Menu.

5.1.2 Backup Footage via Backup Menu

Using the **Backup Menu**, specify start/end dates & times across multiple cameras simultaneously. This is useful for large footage export, such as full days.

1. Select **Backup** from the **Main Menu**, or, insert your USB device and select **File Backup**.
2. Here, you can select the **Type** of footage to backup (default: All), the **Start Time** and **End Time** and what **Record Channels** to backup video from.
3. Selecting **Search** will populate the list with individual video clips ready for backup. Clips can be added or removed from the backup process using the check box.
4. Select **Start** to begin backup.

NOTE: Regular type footage (R) will be split into in one hour segments, unless Motion Detection type footage (M) was recorded.

Storage capacity is also shown. Ensure you have the required storage to accept the backup video.

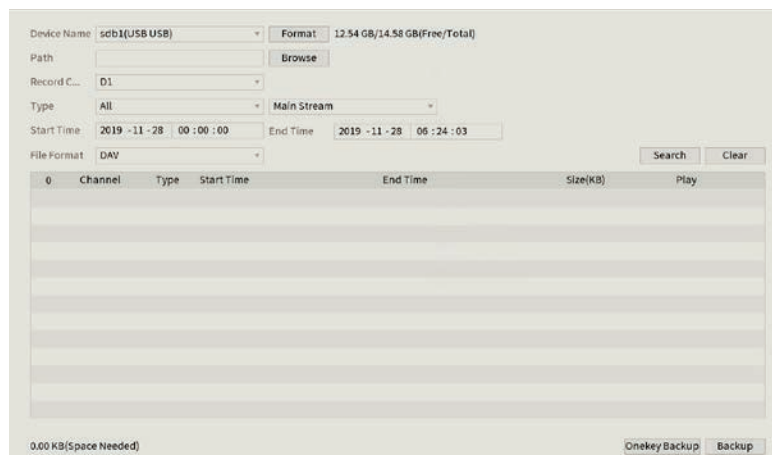

Fig. 5.2: Backup Menu

5.2 Viewing Footage on a Computer





The following details instructions for viewing footage on Windows or Mac personal computers. Video conversion may need to take place for viewing on other devices, eg: smartphones, tablets, etc.

Now that you have backed up footage to a USB in .DAV / .MP4 format, you are ready to view it on a personal computer.

- **.DAV footage** can be viewed using the **Smart Player Lite** program and cannot be played on mainstream media players without file type conversion.
- Smart Player can export your videos to .AVI file type to be viewed using another media player such as Windows Media Player & VLC Media Player
- **.MP4 footage** can be directly viewed using most players, including Windows Media Player & VLC Media Player

5.2.1 Viewing .DAV Video Files on PC with Smart Player Lite

Note: *Smart Player Lite* is automatically copied onto the USB device when performing footage backup from the NVR.

1. To view .DAV footage in Smart Player Lite, either click the **Add Files**  button and select the file from your USB, or drag & drop the file onto a selected play window.
2. Using the .DAV file, Smart Player Lite adds functionality similar to your NVR in footage playback, such as synchronous playback of multiple channels.
3. Open the **Options menu** . Here, you can set the directories and formats for saved snapshots (.BMP/.JPG) and videos (.DAV/.AVI). You can also adjust video aspect ratio and other options.
4. You can **export clips** by pressing the **Record button**  once to begin recording, then again to end recording.
5. Similarly, you can **take snapshots** by pressing the **Snapshot button**  once.

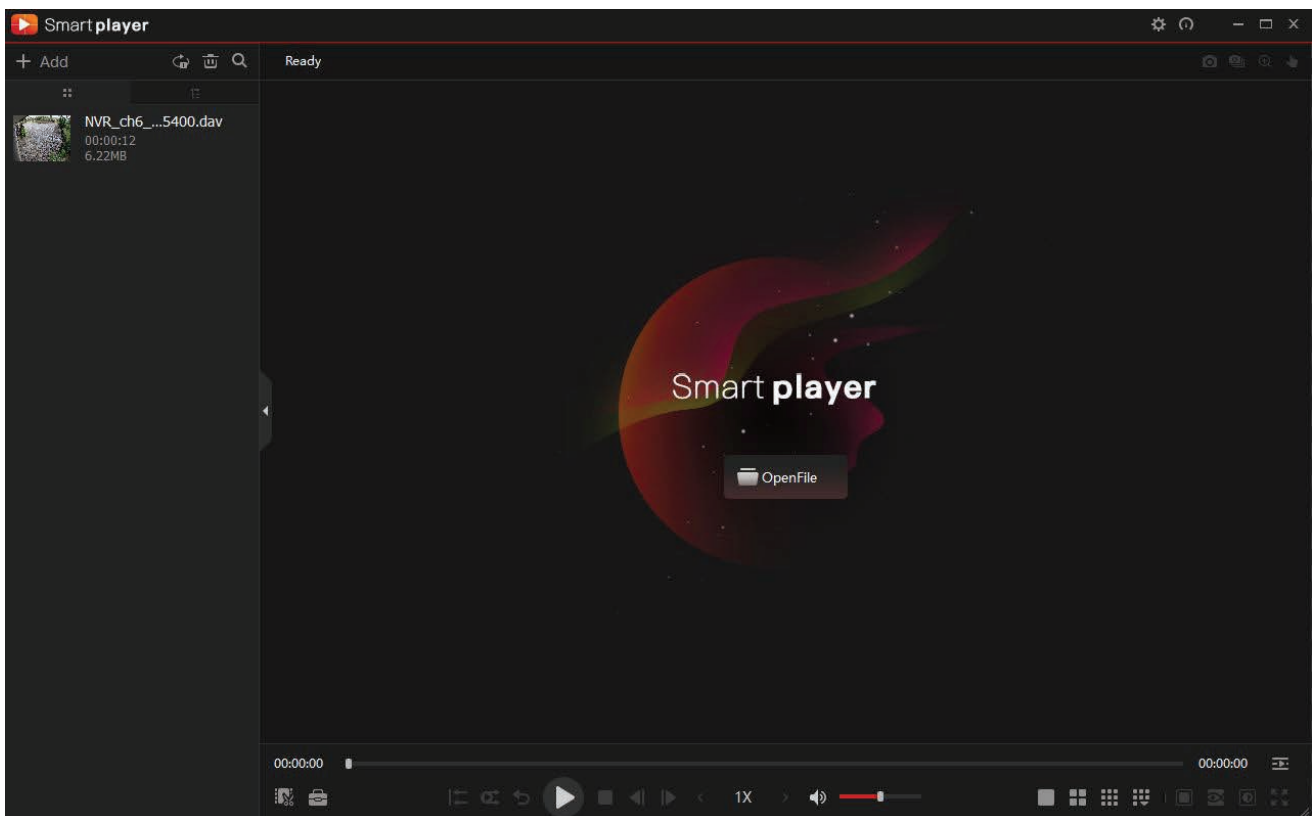

Fig. 5.3: Footage playback using the included Smart Player Lite for Windows

5.2 Viewing Footage on a Computer (cont.)

If you want to play the video on a different device that does not have Smart Player program, select **Export Type** as .AVI. File type .mp4 can be viewed on a wider range of devices, however you cannot choose to export files as .mp4 on the Smart Player program. You must export files as .mp4 via the recorders back up menu.

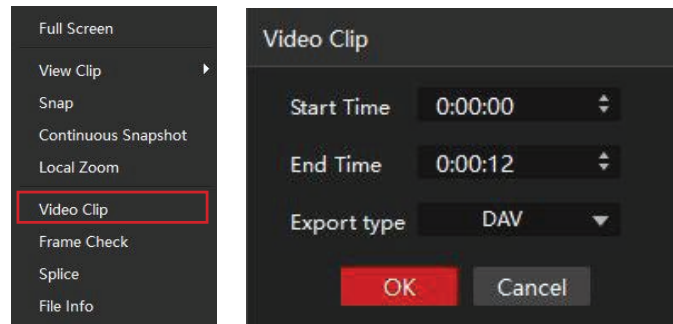

Fig. 5.4: Exporting footage to .AVI File on Smart Player program

5.2.2 Viewing .MP4 Video Files

The .MP4 file format is a common video format, compatible with Windows Media Player and most other video players. .MP4 videos can also be played by **VLC Media Player**. This free open source player is available across many platforms, including:

- **Desktop:** Windows, Mac OS and Linux
- **Mobile:** Android and iOS

1. Access your USB device and open your backup .MP4 footage video using one of the media players mentioned above.
2. .MP4 files **cannot** be viewed using Smart Player Lite. They do not retain time/date data like .DAV files.

Software utilised in this manual was current at the time of manual creation.

For the latest version of surveillance software for PC and Mac systems, please scan the QR code or follow the link to the right.

A brief overview of key software is listed below:

SmartPSS: Remote view application for live view, playback and configuration of your surveillance system. For Windows & Mac PCs.

Smart Player: Playback exported footage & convert video files for Windows & Mac PCs.

DMSS: Mobile surveillance application for iOS & Android



Scan QR code or navigate to:
help.c5k.info/software/software-downloads

6. Intelligent Functions

NOTE: Before enabling IVS or AI features, ensure that you have configured IVS recording schedules (refer to [3.1.7 Configuring Recording Schedules](#)), or these functions will not work.

There are 2 different ways AI can be processed - **By Camera** or **By Device**. By Camera means the AI processing takes place in the camera itself. By Device means the recorder is processing information, not the camera. Please note that only select cameras and recorders support AI functions.

AI lets your CCTV system go beyond surveillance, delivering advanced & powerful detection tools. When properly configured, these functions can alert you to suspicious activity in real time via email/smartphone notification and let you easily search through surveillance footage via event history.

Below will explain the different types of AI functions. Keep in mind that functions are camera and recorder specific.

- **Face Detection** – Face Detection will trigger whenever any face has been detected. Best suited for use directly above entry doors.
- **Face Recognition** – Trigger events upon detecting specific pre-determined faces from a face database. Face Detection must be used in conjunction with Face Recognition,
- **Tripwire** – A virtual line is drawn over the camera image. If it gets broken, an event will be triggered. Suitable for both indoor and outdoor locations, with the camera mounted up high, looking down.
 - * **Perimeter Protection** can also be applied to Tripwire, distinguishing vehicles and cars.
- **Intrusion** – A virtual area is drawn over the image. If it gets broken, an event will be triggered. Suitable for both indoor and outdoor locations, with the camera mounted up high, looking down.
 - * **Perimeter Protection** can also be applied to Intrusion, distinguishing vehicles and cars.
- **Abandoned** – A virtual area is drawn over the image. If an object gets left in the area and event will be triggered.
- **Fast-Moving** – A virtual area is drawn over the image. If a fast-moving object is detected, an event will be triggered. Best suited for outdoor environments such as driveways.
- **Crowd Gathering Estimation** – A virtual area is drawn over the image. If a group of people is detected entering the area, an event will be triggered.
- **Missing** – A virtual area is drawn over the image. If an object is missing in the area, an event will be triggered.
- **Loitering** – A virtual area is drawn over the image. If someone is standing in the area for a set amount of time an event will be triggered. Best suited to a shop.
- **People Counting** – Used to count the number of people going through a specific area and providing statistics. Best suited to a busy environment such as a train station, or shop entry.
- **ANPR** – Automatic License Plate Recognition – Used to trigger events after a number plate is detected.

To properly configure an IVS function, there are several sections of this manual to follow:

- [3.4 Configuring Recording Schedules](#) to enable Motion Detection & IVS recording.
- [6.1 Mounting Surveillance Cameras](#) to ensure cameras are optimally mounted to perform their function.
- [6.3 Motion Detection / 6.4 Tripwire & IVS Setup / 7.1 Face Detection & Recognition](#), depending on which function(s) are being used.
- [7.4 AI Trigger Actions](#) to set which Trigger Actions are activated in response to events.

6.1 Mounting Surveillance Cameras for AI Functions

When using AI features, correct camera mounting is crucial for AI triggers to be reliably received. Use the information below to mount the cameras correctly.

6.1.1 Mounting for Face Detection/Recognition

When using face detection and/or face recognition, the camera will need to be dedicated to the task. It will need to be focused on the entry point to the premises, not covering a wide area.

When installing the camera it is vital to ensure that scene is well lit. Avoid light coming from the back or sides of the scene.

Recommended Mounting Distance

3.6mm 2.0MP IP camera

Parameter	Recommend Value
Height (H)	2.5m
Horizontal Distance (D)	6m
Degrees	15°

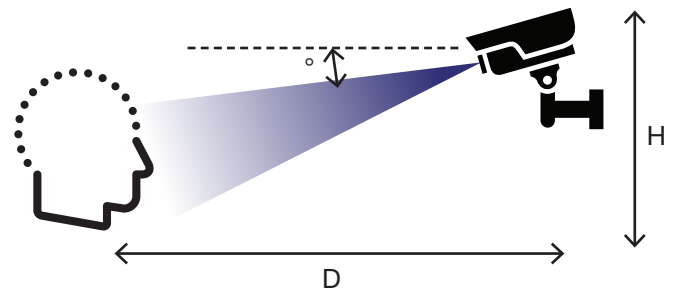

Fig. 6.1: Face Detection mounting diagram

6.1.2 Mounting for ANPR

When using ANPR, the camera will need to be dedicated to the task. It will need to be focused on the entry point to the premises, not covering a wide area. For example, it can be used in a driveway at an electric gate, or at a shopping center with a boom gate.

The camera needs to get a clear image of the number plate, with the vehicle at a standstill.

At night, light emitted from the infrared illumination LEDs on the camera must reflect from the number plate and return into the camera lens. If the angle is too sharp, the light will bounce away from the lens and the number plate will not be readable. At the same time, you must ensure that the camera is mounted in a location where it is not subjected to the direct beam from the vehicle headlights for long enough to get an image – halogen lights will overwhelm the image sensor resulting in glare that cannot be corrected by the software highlight compensation.

ANPR Camera Mounting – From center of driveway

Parameter	Recommend Value
Height (H)	2.5m
Horizontal Distance (D)	6m
Degrees (°)	10°

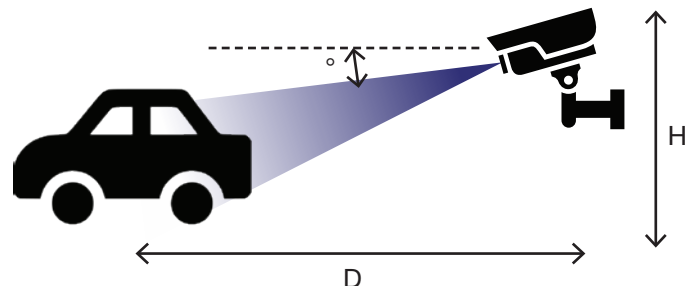

Fig. 6.2: ANPR mounting diagram

6.1 Mounting Surveillance Cameras for AI Functions (cont.)

6.1.3 Mounting for People Counting

When installing a camera for use with people counting, the camera must be looking top down. The doorway must be no more than 3m wide. If the doorway is wider than 3m, a second camera may be required.

People Counting – Distance from Floor – 2MP 3.6mm IP Camera

Parameter	Recommend Value
Height (H)	3m



Fig. 6.3: People Counting camera view example

6.1.4 Mounting for Tripwire, Intrusion, Missing, Abandoned, Fast Moving, and Loitering

When installing a camera for use with any of the above functions, the camera will need to be positioned looking over the area. When the trigger area is drawn, it should not be around the edges of the image, as this will cause inconsistent triggers.



Fig. 6.4: Tripwire camera view example



Fig. 6.5: Intrusion camera view example

6.2 AI Live View

AI Face Detection & Recognition results can be displayed in real-time on the Live View screen. This will show every face that is captured by the AI system, and additionally, if Face Recognition is activated, compare it to faces in the database and show comparison results (with accuracy %).

Enabling AI Mode in Live View

1. While on the Live View screen, **right-click** to open the menu.
2. Hover over **Preview Mode**.
3. By default, the General Preview Mode is enabled. Select **AI Mode**.
4. If AI & IVS have been configured correctly, live face capture results should now be displayed on the right side of the screen.

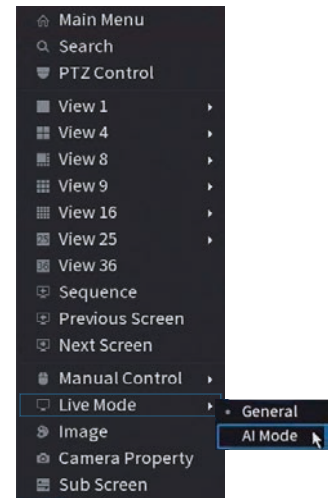

Fig. 6.6: AI Mode in Live View Menu

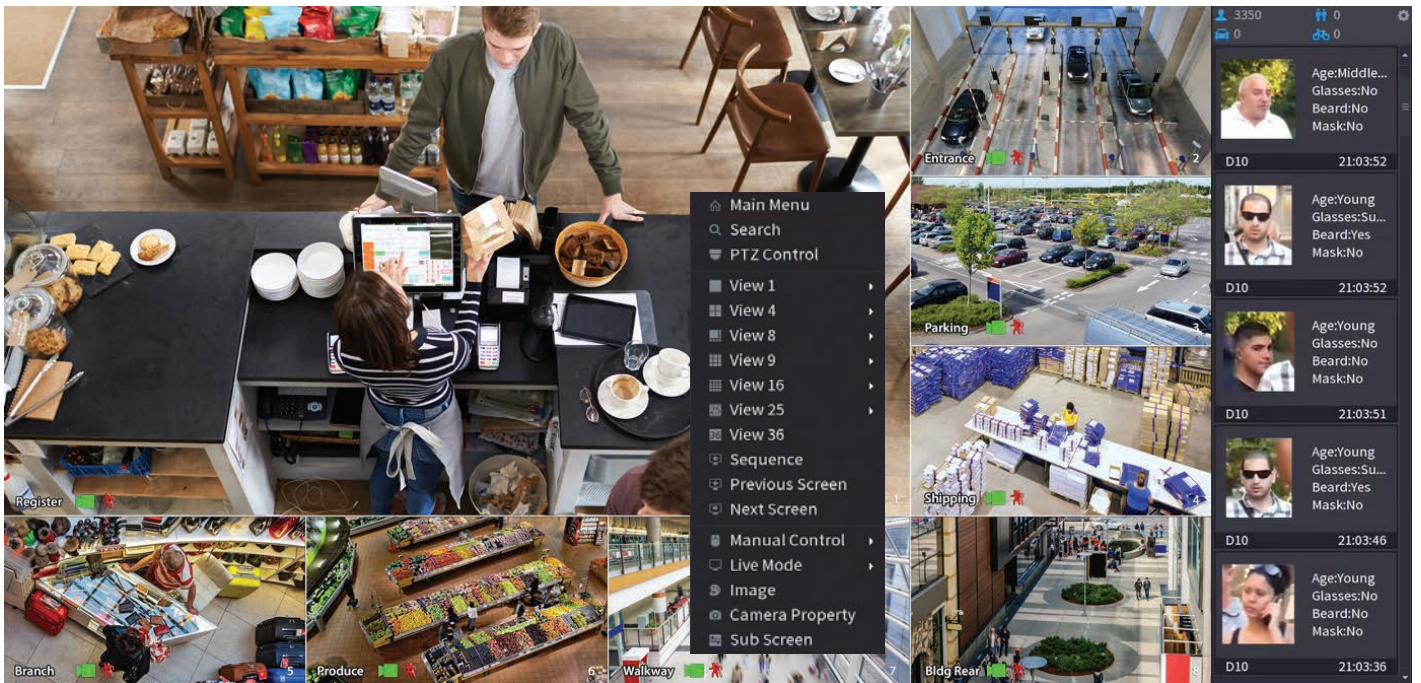

Fig. 6.7: Live playback with Face Detection info on right panel

6.3 Motion Detection

NOTE: Before enabling motion detection, ensure that you've configured MD & Alarm recording schedules (refer to [3.1.7 Configuring Recording Schedules](#)).

6.3.1 Enabling Motion Detection

1. From the **Main Menu**, select **Alarm**.
2. Select the **Video Detection** tab and then the **Motion Detect** Tab.
3. Select the channel you want to **Enable** motion detection on with the drop down menu.
4. After this you can choose to toggle motion detection sensitivity and area by selecting **Region Settings**.
5. You can also configure what actions are taken once the IVS event is triggered.
6. Click **Apply** to confirm settings.

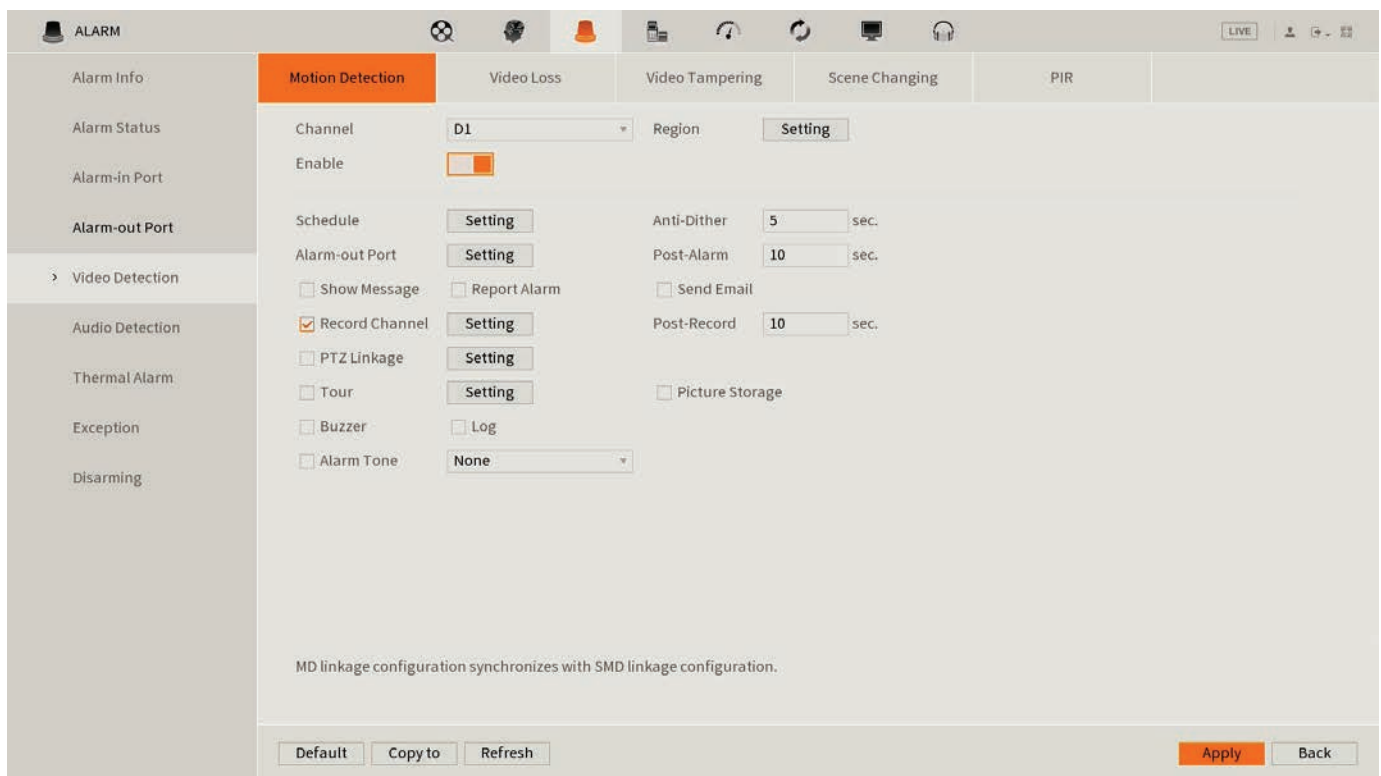

Fig. 6.8: Motion Detection Screen

6.3.2 Smart Motion Detection

Note: Smart Motion Detection is only applicable to AI cameras with Perimeter Protection.



Smart Motion Detection allows the NVR to identify and differentiate vehicles and people from other moving objects. To enable it, follow the same steps for Motion Detection outlined above, then do the following:

1. Return to the **Main Menu** and select **AI**.
2. Select **Parameters -> SMD**
3. Select the **Channel** to apply Smart Motion Detection for, then click **Enable**.
4. Set a **Sensitivity** level, then which **Effective Targets** will trigger it (**Humans, Vehicles or both**).

6.4 Tripwire & IVS Setup

NOTE: Before enabling Tripwire or another IVS feature, ensure that you have configured IVS recording schedules (refer to 3.1.7 [Configuring Recording Schedules](#)).

6.4.1 Tripwire Setup

1. From the Main Menu, select **AI -> Parameters -> Smart Plan**.
2. Select a channel with IVS functionality. Click the  icon then **Apply** to enable the IVS.
3. Select the **IVS** tab. Select the same camera channel, then click **Add button** at the bottom. This will create a new IVS setting (Tripwire by default).
4. Click the **Draw button**  to open the Draw screen (Fig. 6.10).

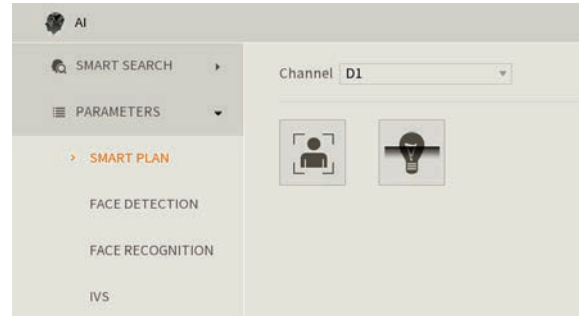

Fig. 6.9: Parameters Smart Plan screen.

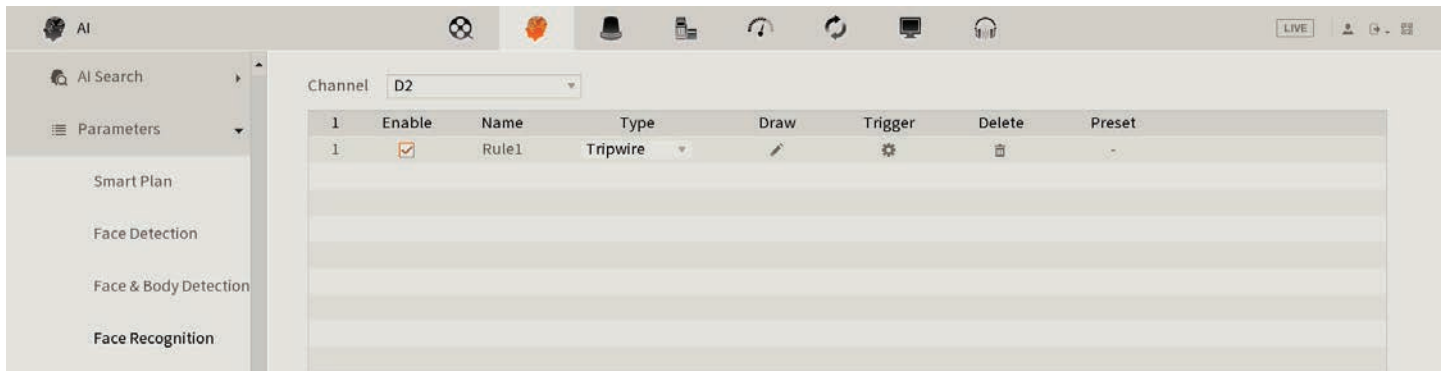



Fig. 6.10: IVS setup screen.

5. **Left-click** on the screen to start drawing the Tripwire line. **Left-click again** to finish the line (optionally, you can add additional corners to the line by continuing to left-click). **Right-click** to finish placing the line.
6. When using select functions such as Tripwire, In the top left window, you can alter the Direction that the line must be passed from to activate the event, as indicated by the arrow going across the line (A to B, B to A, or both ways).
7. (**NOTE:** This step requires an AI camera.) **AI Recognition** enables Perimeter Protection when using Tripwire or Intrusion functions. This will recognise and differentiate between people, vehicles and other moving objects. Turn the option **On** to enable this function.
8. Click OK to finish.
9. Click the **Trigger Button**  to bring up the **Trigger menu**, configuring what actions are taken once the IVS event is triggered. (Refer to 7.4 [AI Trigger Actions](#)).
10. Click the **Enable box** to turn on the IVS rule.
11. Click **Apply** to save changes. If done correctly, you will see the Tripwire in live view.

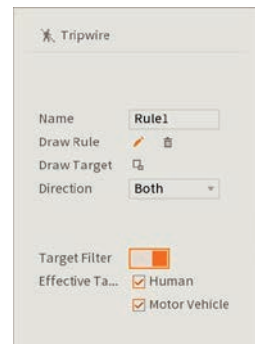

Fig. 6.11: Tripwire Draw menu.

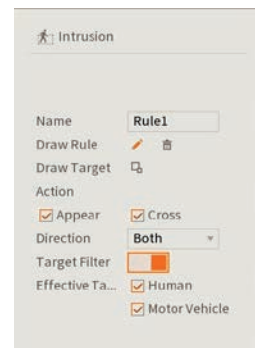

Fig. 6.12: Intrusion Draw menu.

6.3.2 Intrusion/Abandoned/Missing Setup

Intrusion, Abandoned Object and Missing Object are all set up in similar ways to Tripwire - simply select which IVS you want to set up from the **Type dropdown menu** (Fig. 6.10).

7. AI Face Detection

7.1 Face Detection & Recognition

7.1.1 Enabling Face Detection by Device

1. From the Main Menu, select **AI -> Parameters -> Face Detection**. Select the channel you want to set up face detection for.
2. Select the **Enable** button.
3. Select **Rule** to adjust the minimum and maximum face detection size. The minimum and maximum value will depend on how far away the camera is from the faces that are getting captured. In most cases, this setting does not require adjustment.
4. Select **Apply**.
5. Refer to **7.4 AI Trigger Actions** for further trigger settings.

The screenshot displays the 'Face Detection Parameters' configuration interface. It features several sections with adjustable settings:

- Channel:** A dropdown menu currently set to 'D2'.
- Enable:** A toggle switch that is turned on (orange).
- Face Enhance...:** A toggle switch that is turned on (orange).
- Rule:** A button labeled 'Setting'.
- Schedule:** A button labeled 'Setting'.
- Alarm-out Port:** A button labeled 'Setting'.
- Post-Alarm:** A numeric input field set to '10' followed by 'sec.'.
- Report Alarm:** An unchecked checkbox.
- Send Email:** An unchecked checkbox.
- Record Channel:** A checked checkbox (orange) followed by a 'Setting' button.
- PTZ Linkage:** An unchecked checkbox followed by a 'Setting' button.
- Tour:** An unchecked checkbox followed by a 'Setting' button.
- Buzzer:** An unchecked checkbox.
- Log:** A checked checkbox (orange).

Fig. 7.1: Face Detection Parameters menu

7.1 Face Detection & Recognition (cont.)

Used in conjunction with Face Detection, Face Recognition can detect people that have been added to a “Face Library”, and trigger events off this. Generally, this function is used to trigger an action on the recorder when a person in a pre-determined face list is seen.

Before enabling Face Recognition, ensure that Face Detection is setup first.

1. From the Main Menu, select **AI -> Database -> Face Library**.
2. Select **Add**. Give the Face Library a name, and then select **OK**.

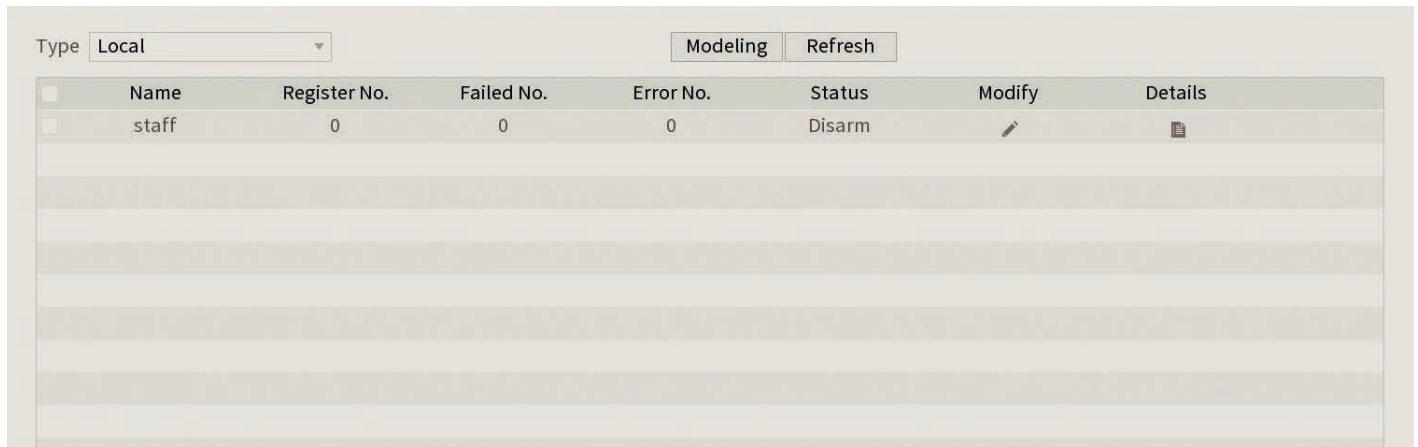

Fig. 7.2: Face Library menu

3. Select **Parameters -> Face Recognition**.
4. Select the channel you wish to setup Face Recognition on. Select **Enable**.
5. Select **Target Face Database Setting** and select the Face Library you created. Select **OK**.
6. Select **Common Mode** or **Stranger Alarm**. Common Mode will detect faces in the Face Library. Stranger Alarm will detect faces not in the Face Library and mark them as strangers.
7. Configure the trigger settings to suit your requirements (Refer to [7.4 AI Trigger Actions](#)).
8. Select **Apply** to save your changes.

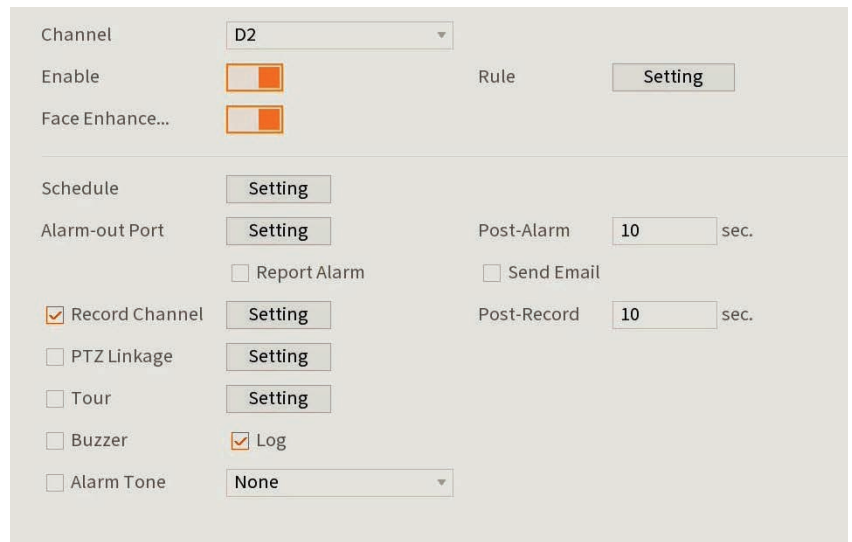

Fig.7.3: Face Recognition menu

7.2 Adding Faces to the Face Library

7.2.1 Method 1 - Add from a Captured Face Detection

1. Ensure **AI Preview mode** is configured as per section 3.1
2. Once a face appears in the list you would like to add to the Face Library, **double click** on it, and select **Add to Human Face Database**.
3. Enter the details of the person and select the **Face Library** you would like to add the face too.
4. Select **OK**.

1	✓	Face Library...	Registered No.	Failure peo...	Error peop...
1	✓	Staff	0	0	0

Fig. 7.4: Add to Human Face Database window

7.2.2 Method 2 - Manual Photo Upload via USB Flash Drive

This method is useful if multiple faces are being added to the face database. You can also choose to import the faces and data, by naming the images files, explained below:

Name#SGender#BIBirthday#NCountry#TIDType#MIDNo.#AAddress.jpg

Gender: 1 Male, 2 Female / Identity: 1 – Identity Card, 2 - Passport, 3 – Military Office Passport

Example: John#S1#B19900101#NAustralia#T1#M123456789#1 Smith St Sydney 2000 NSW.jpg

1. Save the face/faces to a .jpg image file on a USB Flash drive.
2. Insert the USB Flash Drive into a free USB Port on the NVR.
3. From the Main Menu, select **AI -> Database -> Face Library**.
4. Select **Details**.
5. Select **Batch Register**, then select **File** or **Folder**, and select the photos you wish to upload.
6. The recorder will then upload the files. Once complete, press **Search** to update the Face Library
7. Select the **Edit** icon next to the faces that have been added, to update name and other details.

The image format shall be: .jpg
Naming format: Name#SGender#BIBirthday#NCountry#Regions#TID Type#MID No.#AAddress.jpg(Name required, others optional)
e.g. Tom#S1#B19900101#NUS#T1#M123456789#North Main Street.jpg
Gender: 1.Male 2.Female
Type: 1.IdentityCard 2.Passport 3.Military Officer Passport

Fig. 7.5: Face details menu

7.2.3 Deleting Faces from Face Library

To remove a face from a face library, select **AI -> Database -> Face Library**. Select the **Details** button in the face library to view the faces that have been added to it. Select the face you wish to delete, then select **Delete**.

7.3 AI Trigger Actions

The options below the enable button on the **Parameters** tab configure the actions taken after an event has been triggered such as face detection, or tripwire.

1. **Schedule** - Sets the times of day that the event will trigger (always on by default).
2. **Alarm Out** - Sets an external alarm to activate whenever a face is detected.
3. **Post-Alarm** - Sets how long the system waits after a trigger before detecting again (10 seconds by default).
4. **Report Alarm** - Updates the alarm system status on the network (Unused for this system).
5. **Send Email** - Notifies a specified email address whenever the event is triggered (Requires internet connection & setup)
6. **Record Channel** - Sets which camera to record to when the event is triggered.
7. **Post-Record** - Sets the amount of time recorded after the event is triggered.
8. **PTZ Activation** - Set PTZ behaviours in response to an event trigger, such as selecting a Tour to perform, etc (For use with PTZ camera(s) only).
9. **Buzzer** - Sets the NVR to beep whenever an event is triggered.
10. **Alarm Tone** - Plays a designated .wav file in response to an event trigger. This can be imported via a USB flash drive to the NVR.

The screenshot shows a web interface titled "Trigger" with various configuration options. Each option has a checkbox and a "Setting" button, except for "Post-Alarm" and "Post-Record" which have numeric input fields. "Record Channel" is checked, and "Log" is also checked. "Alarm Tone" is set to "None".

Option	Value / Action
Schedule	Setting
Alarm-out Port	Setting
Report Alarm	<input type="checkbox"/>
Record Channel	<input checked="" type="checkbox"/> Setting
PTZ Linkage	<input type="checkbox"/> Setting
Tour	<input type="checkbox"/> Setting
Buzzer	<input type="checkbox"/>
Alarm Tone	None
Post-Alarm	10 sec.
Send Email	<input type="checkbox"/>
Post-Record	10 sec.
Log	<input checked="" type="checkbox"/>

Buttons: OK, Back

Fig. 7.6: Trigger Actions menu

8. Smart Search

Smart Search for SMD, Face Detection, Vehicle Detection, Non-Motor Vehicle Detection or Human Body Detection. The available options will vary depending on the camera and recorder model. The AI function must be turned on to be able to perform a Smart Search.

8.1 Face / Vehicle / Non-Motor Vehicle / Human Body Detection

1. From the Main Menu, select **AI -> Smart Search** then **Face Detection, Vehicle Detection, Non-Motor Vehicle Detection or Human Body Detection**.
2. Select the channel, time and attributes you would like to search for, then select **Smart Search**.
3. If any faces were detected in the specified timeframe, they will be displayed along with a timestamp. Double-click on one of the faces to view the recorded footage.
4. If you wish to backup footage, insert a USB stick, put a tick next to the item you want to backup, and select **Export**. Then you will be asked where on the USB Stick the file is to be saved.
5. Select **OK** to start the backup.

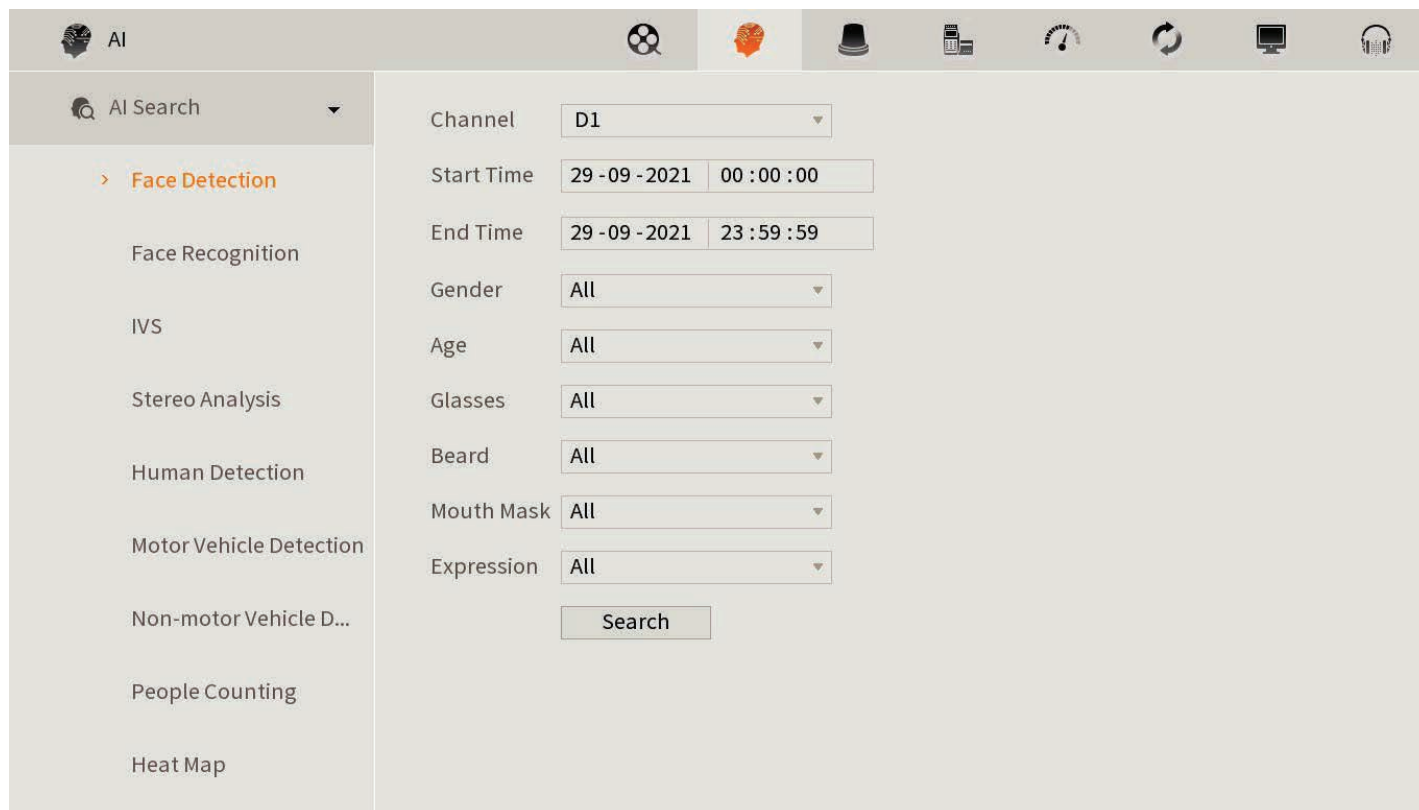

The screenshot shows a software interface for AI Search. At the top, there is a navigation bar with icons for AI, Search, Face, Vehicle, Non-Motor Vehicle, and Human Body. Below this, the 'AI Search' menu is open, showing a list of options on the left and a search configuration panel on the right. The 'Face Detection' option is highlighted in orange. The search configuration panel includes the following fields:

Channel	D1
Start Time	29 -09 -2021 00 :00 :00
End Time	29 -09 -2021 23 :59 :59
Gender	All
Age	All
Glasses	All
Beard	All
Mouth Mask	All
Expression	All

At the bottom of the search configuration panel, there is a 'Search' button.

Fig. 8.1: Face Detection Smart Search menu

8.2 Face Recognition Smart Search

8.2.1 Method 1 - Search by Attribute

1. From the Main Menu, select **AI -> Smart Search -> Face Recognition**. Select the **Search By Attribute** tab.
2. Select the channel, time and facial features you would like to search for, then select **Smart Search**.
3. If any faces were detected in the specified timeframe, they will be displayed along with a timestamp. **Double-click** on one of the faces to view the recorded footage.
4. If you wish to backup footage, put a tick next to the item you want to backup, and select **Export**. Then you will be asked where on the USB Stick the file is to be saved.
5. Select **OK** to start the backup.

8.2.2 Method 2 - Search by Image

1. From the Main Menu, select **AI -> Smart Search -> Face Recognition**. Select the **Search By Image** tab.
2. Select the **Face Library** to search for a Face that is already saved to the Face Library or select **Local Upload** to import a new face via a USB Stick.
3. Select the Face, and select the channel and date and time, then **Smart Search**.
4. If any faces were detected in the specified timeframe, they will be displayed along with a timestamp. **Double-click** on one of the faces to view the recorded footage.
5. If you wish to backup footage, put a tick next to the item you want to backup, and select **Backup**. Then you will be asked where on the USB Stick the file is to be saved.
6. Select **OK** to start the backup.

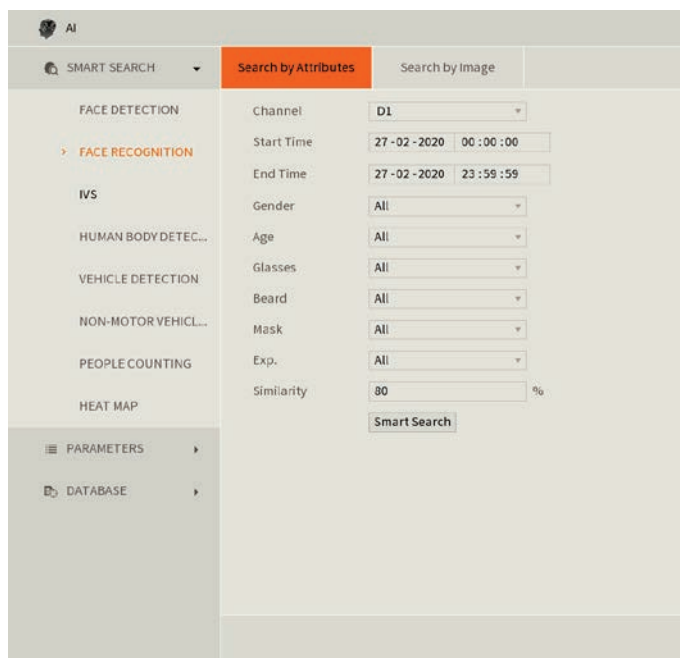

Fig. 8.2: Search by Attributes menu

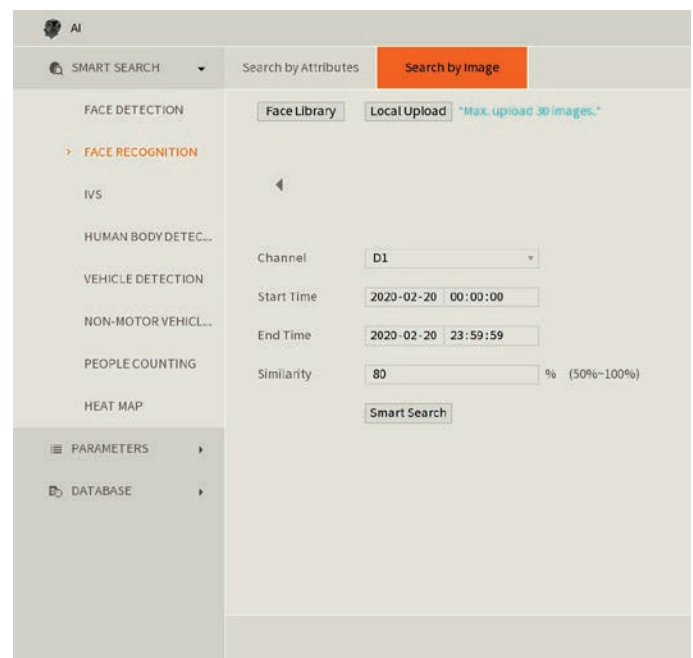

Fig. 8.3: Search by Image menu

9. Troubleshooting

This concludes the Quick Start Guide covering the basic functionality of your surveillance system. Should you encounter any difficulties with your setting up and using your system, please first refer to the tables below.

Area	Menu Navigation	Guide Ref.
NVR Security Setup	Main Menu -> Management-Account -> Security	Section 3.1.3
Changing General Settings	Main Menu -> Management-System -> General	Section 3.1.2
NVR Network Setup	Main Menu -> Management-Network -> TCP/IP	Section 3.1.4
P2P & Remote View Setup	Main Menu -> Management-Network -> P2P	Section 3.1.4
Configuring Cameras	Main Menu -> Management-Camera -> Camera List	Section 3.1.5
Changing Recording Schedule	Main Menu -> Management-Storage -> Schedule	Section 3.4.2
Display Settings	Main Menu -> Display	Section 3.5
Accessing Playback Footage	Main Menu -> Search	Section 4
Backing Up Footage	Main Menu -> Backup	Section 5
Intelligent Function Setup	Main Menu -> AI -> Parameters -> Smart Plan	Section 6

Problem	Troubleshooting	Guide Ref.
The NVR won't power on.	<ul style="list-style-type: none"> Ensure that the power cable is firmly connected to the recorder & wall socket. Confirm that there is power from the outlet. 	Section 1.2
The NVR is not being displayed on the monitor.	<ul style="list-style-type: none"> Ensure the display cable is firmly connected to the recorder & monitor. Ensure you have selected the correct input on your monitor. Reset the NVR resolution by powering on the unit while holding SHIFT. Test the recorder's display output with different monitor. 	Section 1.2
Cameras aren't displaying live video.	<ul style="list-style-type: none"> Ensure that you are not in playback mode, right mouse click to exit. Ensure the camera is connected to the CAT5e or CAT6 cable, and the camera has been terminated to TIA-568A or TIA-568B Standard. Swap with known working cables and cameras to test. 	Section 1.2
The NVR is not recording video.	<ul style="list-style-type: none"> Check Storage -> Record is set to "Auto". Check if the HDD is installed and properly connected. Check that the recording method you have chosen to implement is in use. 	-
Motion is not being detected or recorded by the NVR or unable to Smart Search.	<ul style="list-style-type: none"> Check that motion detection is enabled by navigating to Main Menu -> Alarm Alarm -> Video Detection -> Motion Detect. The Enable check box should be switched on for all relevant channels. Ensure that a period has been selected in the Recording Schedule for motion detection recording and that the period is filled in yellow. Check motion sensitivity and adjust motion detection area, see: Main Menu -> Alarm -> Video Detect: Motion Detect -> Region Settings 	Section 3.1.7
Cannot connect to NVR on smartphone or tablet.	<ul style="list-style-type: none"> Ensure that the NVR & device are connected to the Internet and that the connection is strong enough to receive video (min. 3G speeds). Check that P2P is Online in Network -> P2P. If offline, turn DHCP on. Ensure that the admin password is correct in the DMSS app Ensure the extra stream settings are set to recommended settings. 	Section 3.1.5
The recorder will not detect a USB device for backup.	<ul style="list-style-type: none"> If a USB device is detected but you are unable to backup footage to it, format it by using the Format button on the Backup page. NOTE: This will erase all data on the USB Ensure that the USB device is formatted to FAT32 or NTFS. Try using another USB flash drive to test compatibility. 	Section 5.1
Face Detection / IVS features are not working correctly.	<ul style="list-style-type: none"> Check that Smart Plan is enabled. Ensure that IVS (blue) recording schedules have been set up in Schedule. Ensure that Enable has been checked for each rule on the IVS screen. 	Section 3.1.7 Section 6.3
Decode Disabled	<ul style="list-style-type: none"> Ensure you are connected to HDMI1 if only using one display. Turn on "Enable Decode" for Sub Screen if using two HDMI/Both VGA and HDMI 	-



For detailed technical support and software downloads,
visit our Help Centre at: help.c5k.info

All products, designs and software may be subject to change without prior written notice. Information, layout and graphics presented in this guide are the property of their respective owners.

See www.c5k.info for more information.