

THOR-25

Variant		Item No.	Description
Blk	Wht		
22410	22414	THOR-25-3-36D	LED Tracklight, 36° beam angle. 3000K warm white.
22411	22415	THOR-25-3-36D	LED Tracklight, 36° beam angle. 4000K neutral white.

Thank you for purchasing your new LED THOR-25, Please take the time to read and understand the instruction sheet below. Failure to do so may void warranty.

Specifications

Voltage:	240V AC	Lumen (±5%):	Warm White 3000K - 1751lm Neutral White 4000K - 2011lm	Dimmable:	Yes*
Power:	25W	Beam Angle:	36°	Operating Temp:	-20°C~50°C
IP Rating:	IP20	CCT:	3000K - 4000K	Lifespan:	50,000hrs
CRI:	≥90				

*Fully dimmable with suitable dimmers

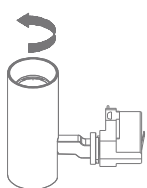
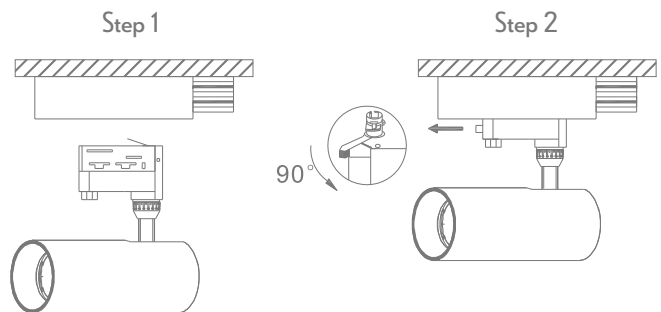

Honeycomb Installation

1. Unscrew the baffle anticlockwise, and remove from fitting.
2. Take out the lens holder.
3. Place the honeycomb reflector into the baffle followed by the lens holder.
4. Screw baffle back into fitting in a clockwise direction.

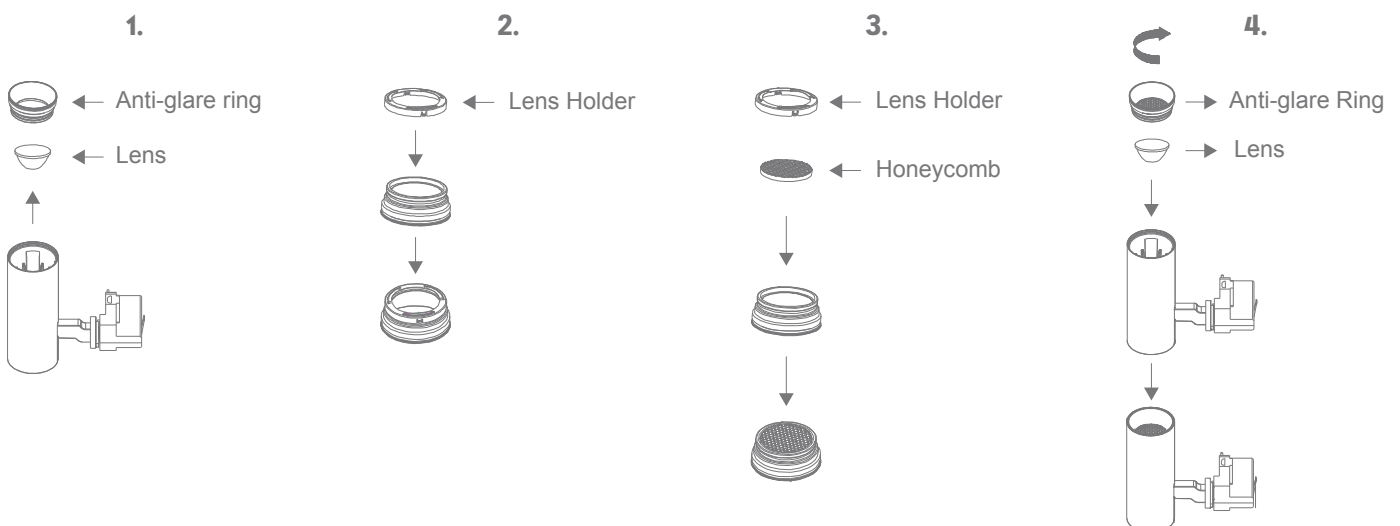

Note: -The lamp must be installed by professional electrician
-Ensure the power supply is switched off before fitting this product

-Do not touch the lamp when in use
-Keep away from hot steam and corrosive gas