

Installation Manual

SOLAR-RND-200-TRIO

Order Code	Product Code	Description
20938	SOLAR-RND-200-W-TRIO	15W Ceiling Light Oyster, TRIO. Satin White Finish
20939	SOLAR-RND-200-B-TRIO	15W Ceiling Light Oyster, TRIO. Black Finish

Thank you for purchasing your new LED SOLAR-RND-200-TRIO, Please take the time to read and understand the instruction sheet below. Failure to do so may void warranty.

Specifications

Voltage:	AC 240V	Lumen (±5%):	Warm White 3000K - 1350lm Neutral White 4000K - 1400lm White 5700K - 1450lm	Dimmable:	Yes*
Power:	15W	Beam Angle:	120°	Operating Temp:	-20°C~45°C
IP Rating:	54	CCT:	3000K - 4000K - 5700K (Switchable)	Power Factor:	≥0.9
CRI:	≥80	Lifespan:	40,000hrs		

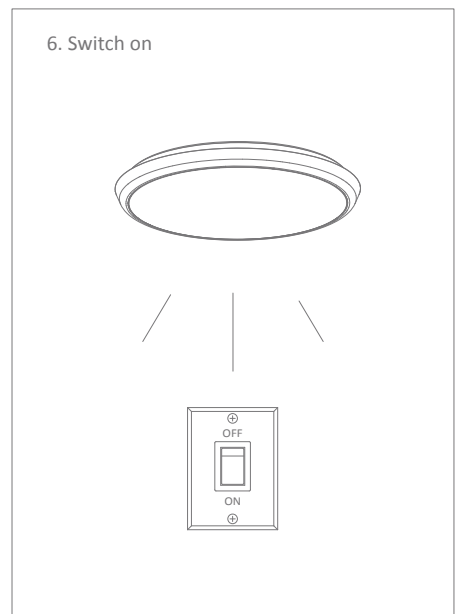
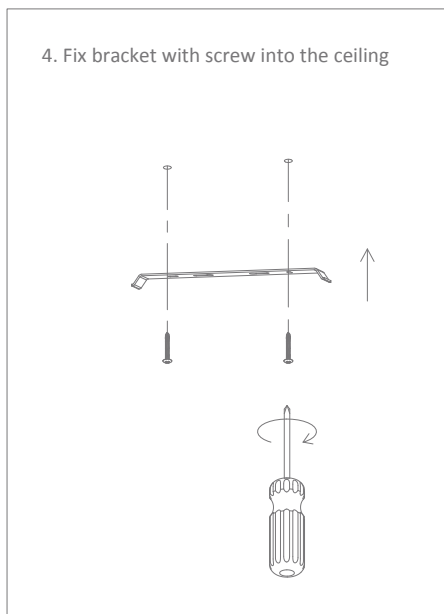
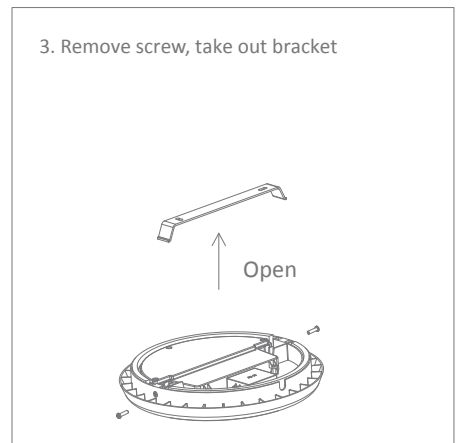
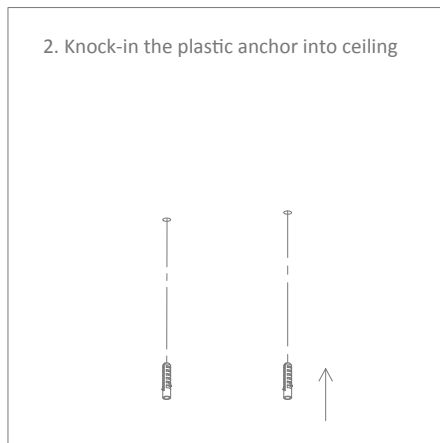
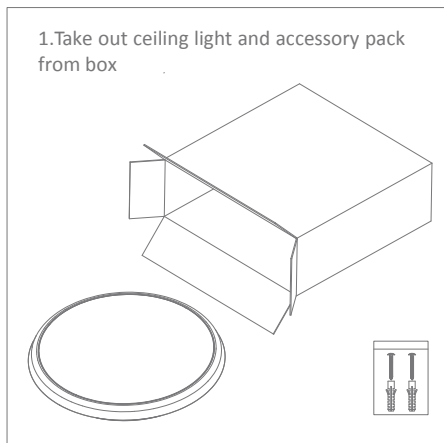

Note: -The lamp must be installed by professional electrician
-Ensure the power supply is switched off before fitting this product

-Do not touch the lamp when in use
-Keep away from hot steam and corrosive gas