

Veko Wall Light with Eyelid Installation Instructions



Product Specifications

Model No.	HV2928T-BLK-12V	HV2928T-WHT-12V	HV2928T-BLK-240V	HV2928T-WHT-240V
Name	Veko			
Material	Aluminium			
Colour	Black	White	Black	White
IP Rating	IP65			
Installation Type	Wall - Surface Mounted			
Input Voltage	12v DC		240v AC	
Protection Class	3 (Low Voltage) ⚡		1 (Requires Earth) ⚡	
Lamp Base	Built in LED		Built in LED	
Lamp Wattage	6w		6w	
Colour Temp	TRI Colour - 3000k, 4000k, 5500k		TRI Colour - 3000k, 4000k, 5500k	
Lumens	300lm, 310lm, 305lm		300lm, 310lm, 305lm	
CRI	> 80			
Wiring	Parallel			
Dimmable	No			
Warranty	3 Years Replacement*			

Important Safety Issues:

- This product must be installed by a qualified electrician according to AS/NZS 3000.
- Ensure all electrical mains are disconnected before any installation.
- Modification of this product will void any warranty.
- Havit Lighting does not take responsibility for wrong installation, incorrect use, or use of installation material that does not belong to the system.
- When installing low voltage fittings, Voltage to fitting must be within +or- 5% of voltage required and cannot be installed more than 25m from LED Driver, if not within this allowance warranty will be voided.
- Aluminium and 304SS fittings must not be installed within 5km of any salt water environments.
- All o-rings and seals must be in place correctly to maintain warranty.
- These instructions may be updated at any time due to product improvements, Please visit website for most current installation instructions.

Dimensions

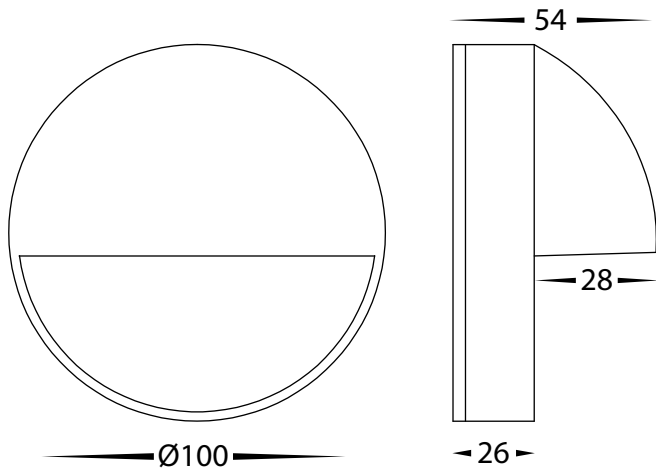

Mounting Base

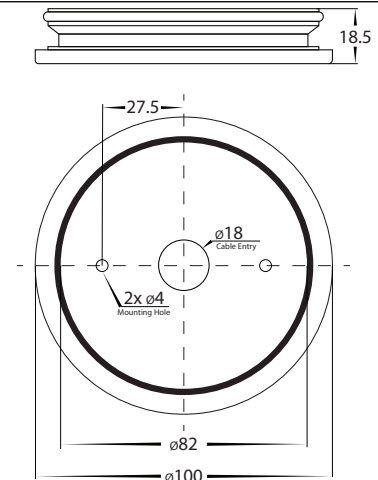

Steps for Installation:

1. Make sure that the electrical circuit is free of voltage (master switch off)
2. Loosen or remove allen screws from side of fitting as set aside if removed.
3. 240v Model - Use wire with earth; connect the earth first, then live and neutral wire.
4. 12v DC Models - Using an appropriate 12v DC Constant Voltage LED Driver - DO NOT CONNECT LIGHT FITTING DIRECTLY TO 240V.
5. Connect the cable - If more than one fitting installed, wiring must be done in parallel.
6. Strip back the cable on both fitting and cable run and (for 240v Models - twist the earth cables together first) twist the positive cables together. Then connect neutral cables together.
7. Solder all joins using solder and either a heat gun or butane gas torch.
8. Cover connections using an adhesive lined heat shrink or gel cap to make connection watertight. Failure to do this will void warranty.
9. Heat the heat shrink or crimp the gel cap making sure all connections are covered.
10. Install base plate in desired location, Seal all holes in the backing plate including cable entry and screw holes.
11. Fitting is preset to 3000k, To change move switch located inside fitting to desired colour temperature.
12. Reattach face onto fitting making sure seals are still in place
13. Reinsert allens screws if removed and tighten making sure seals are still in place to avoid water penetration into fitting.
14. Apply silicon around edge of fitting to prevent any water from getting inside to electrical connections.
15. All connections must be carried out carefully, inspect all contacts before switching back on the electric circuit.

Must be installed by a licensed electrician

Contact Details:

143 Beauchamp Road
Matraville NSW 2036
Australia
Tel: 02 9381 8300
Fax: 02 9666 8881
Email: sales@havit.com.au
Web: www.havit.com.au

Warranty Terms & Conditions*



www.havit.com.au

