

Klip Inground Light Installation Instructions



Product Specifications

Model No.	HV1835T-12V	HV1835T-240V
Name	Klip	
Material	316 Stainless Steel cover + Aluminium body	
Colour	Cover - Stainless Steel Body - Black	
Trafficable	Yes - 1000kg	
IP Rating	IP67	
IK Rating	IK10	IK10
Installation Type	Ground - Recessed	Ground - Recessed
Input Voltage	12v DC - Constant Voltage	240V
Protection Class	3 (Low Voltage, no earth required) ⚡	1 (Requires Earth) ⚡
Lamp Base	Built In LED	
Lamp Wattage	1x 30w	1x 30w
Colour Temp	Tri Colour - 3000k, 4000k, 5500k	Tri Colour - 3000k, 4000k, 5500k
Lumens	2400lm, 2550lm, 2700lm	2400lm, 2550lm, 2700lm
CRI	> 80	
Wiring	Parallel	
Dimmable	No	
Warranty	3 Years Replacement*	

Important Safety Issues:

- This product must be installed by a qualified electrician according to AS/NZS 3000.
- Ensure all electrical mains are disconnected before any installation.
- Modification of this product will void any warranty.
- Havit Lighting does not take responsibility for wrong installation, incorrect use, or use of installation material that does not belong to the system.
- When installing low voltage fittings, Voltage to fitting must be within +or- 5% of voltage required, if not within this allowance warranty will be voided.
- Aluminium and 304SS fittings must not be installed within 5km of any salt water environments.
- All 316 stainless steel fittings must have regular cleaning maintenance to avoid any tea staining from forming on fitting. (Warranty does not cover Tea Staining)
- All o-rings and seals must be in place correctly to maintain warranty
- When installing inground light fittings, Adequate drainage must be allowed to prevent fittings from sitting in water for a long period of time, if no drainage is allowed, Warranty will be voided, See sample adequate drainage diagram for correct installation method.
- This form may be updated at any time due to product improvements please check online installation form for most current version.

Dimensions

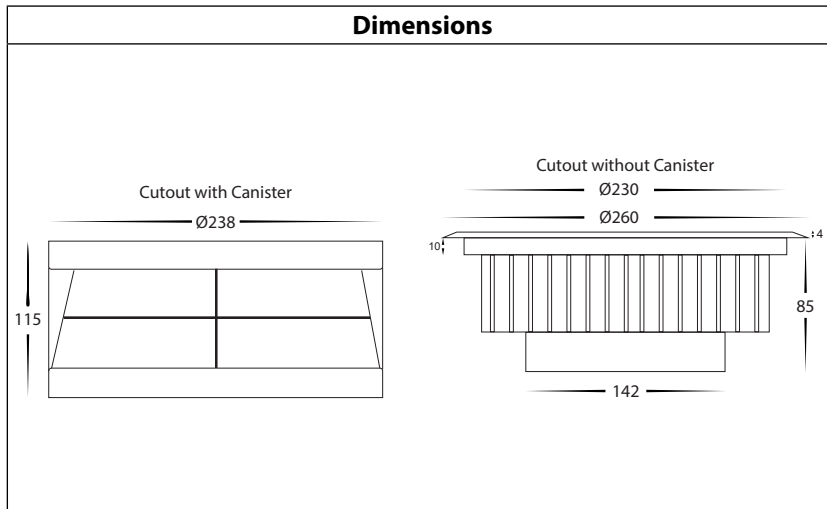

Adequate Drainage Diagram

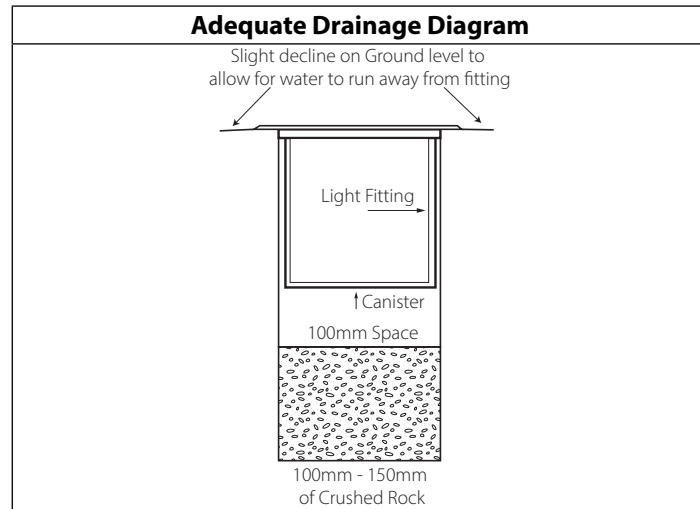

Steps for Installation:

1. Make sure that the electrical circuit is free of voltage (master switch off)
2. Make a hole where fitting is to be placed using dimensions provided on line drawings, making sure adequate drainage is allowed.
3. Insert canister, and ensure that the top is level with ground or floor. Failure to do so will void warranty.
4. HV1835T-240V - Use wire with earth; connect the earth first, then live and neutral wire
5. HV1835T-12V - Using an appropriate 12v DC Constant Voltage LED Driver - DO NOT CONNECT LIGHT FITTING DIRECTLY TO 240V
6. To connect the cable, strip back cable on both fitting and cable run and twist the earths together first for 240v model, then positive cables from fitting to positive on the cable run. Then connect neutral cables from fitting to neutral on cable run.
7. Solder all joins using solder and either a heat gun or butane gas torch.
8. Cover connections using an adhesive lined heat shrink or gel cap to make connection watertight. Failure to do this will void warranty.
9. Heat the heat shrink or crimp the gel cap making sure all connections are covered.
10. Make sure the seals are still in place and nuts are tight to avoid any water penetration.
11. Fitting is preset to 3000k, To change locate switch on bottom of fitting inside sealed brass cover, move switch to desired colour temperature and reattach cover making sure its tight.
12. Insert fitting into canister. Apply silicon around edge of fitting to prevent any water from getting inside to electrical connections.
13. All connections must be carried out carefully, inspect all contacts before switching back on the electric circuit.

Steps for Installation: HV1835-F-SH

1. Remove nuts on back of fitting and set aside
2. Remove cover and replace with security face
3. Reattach nuts and tighten making sure seals are still in place
4. Insert fitting into canister
5. Insert screws and tighten

Steps for Installation: HV1835-HC

1. Remove nuts on back of fitting and set aside
2. Remove cover and glass and set aside
3. Insert Honeycomb lens on the inside of the glass
4. Reinsert glass onto fitting and place cover over glass
5. Reattach nuts and tighten making sure seals are still in place

Must be installed by a licensed electrician

Contact Details:

143 Beauchamp Road
Matraville NSW 2036
Australia
Tel: 02 9381 8300
Fax: 02 9666 8881
Email: sales@havit.com.au
Web: www.havit.com.au

Warranty Terms & Conditions*



Additional Information

