



# PLUGS AND SOCKET OUTLETS SERIES P-NOVA AND TAURUS





# Plugs and socket outlets – Series P-Nova and Taurus

## P-Nova

The socket outlet with earthing contact Page **146**



## Nautilus

watertight flanged sockets Page **160**



## Taurus

Plug and connector systems Page **166**



## Top Taurus

Plug and connector systems Page **174**



## Special plugs and sockets

Multiple socket outlets Seite **178**



Adaptors Seite **180**



Testing plugs and adaptors Seite **181**



## The socket outlet with earthing contact

The „P-Nova“ socket outlet with earthing contact is characterized in particular by its:

- robust construction based on high-grade polyamide, 
- screwless connection technology or screw contact system (connection from the rear or the side)
- various flange sizes
- four-point mounting
- special sealing contour for IP54 on the backside



### Screw contact system

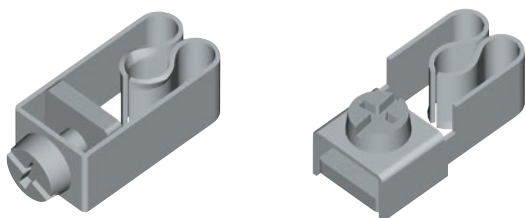

Connection from the rear      Connection from the side

### Screwless connection technology

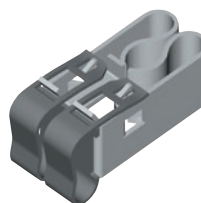

With spring-clamp (screwless)  
Connection from the rear

### Technical data

-  IP54
- flange dimensions: 50x50 as standard, 70x70 as well as 75x75
- hinged lid with wide opening angle
- high closing pressure on hinged lid
- finger protection VBG4

### Spring-clamp connection technology

- spring-clamp with connection from the rear
- pre-tensioned release mechanism - no tool needed for initial connection
- connection without an end sleeve possible
- double connection through independent spring-clamps for wiring through

### Connection

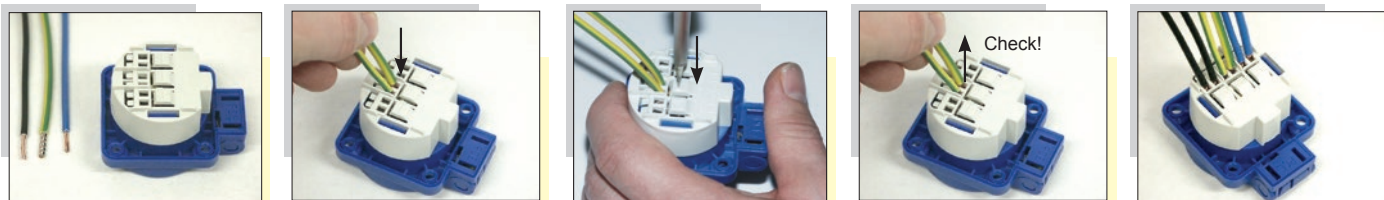

### Re-connection



## P-Nova plus – Product features

- + **minimized contact carrier**  
for mounting in narrow surroundings (cable reels)
- + **optimum screw contacts**
- + **open contact screws**
- + **hinged lid with wide opening angle, high closing pressure**
- + **flange size 50x50mm**  
(thinner flange, no separate gasket necessary)
- + **fixing center 38x38mm (fourpoint-mounting with countersunk screw)**
- + **IP54 splashproof** 
- + **high stability by single-part housing**  
also in case of child protection (shutter)!
- + **robust construction based on highgrade polyamide 6**
- + optional: **approved child protection for all types**
- + **Austrian/German versions according to DIN VDE 0620-1st of February 2010**
- + Minimum quantity for ordering special versions: 1.000 pieces

### Child protection (shutter)

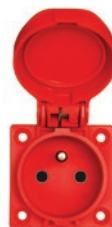

### Belgian/French standard

Earth pin with single part terminal (also available in version with child protection (shutter))



### Screw contact systems



Connection from the side

Connection from the rear



# Safety plug and socket system in EUROPE

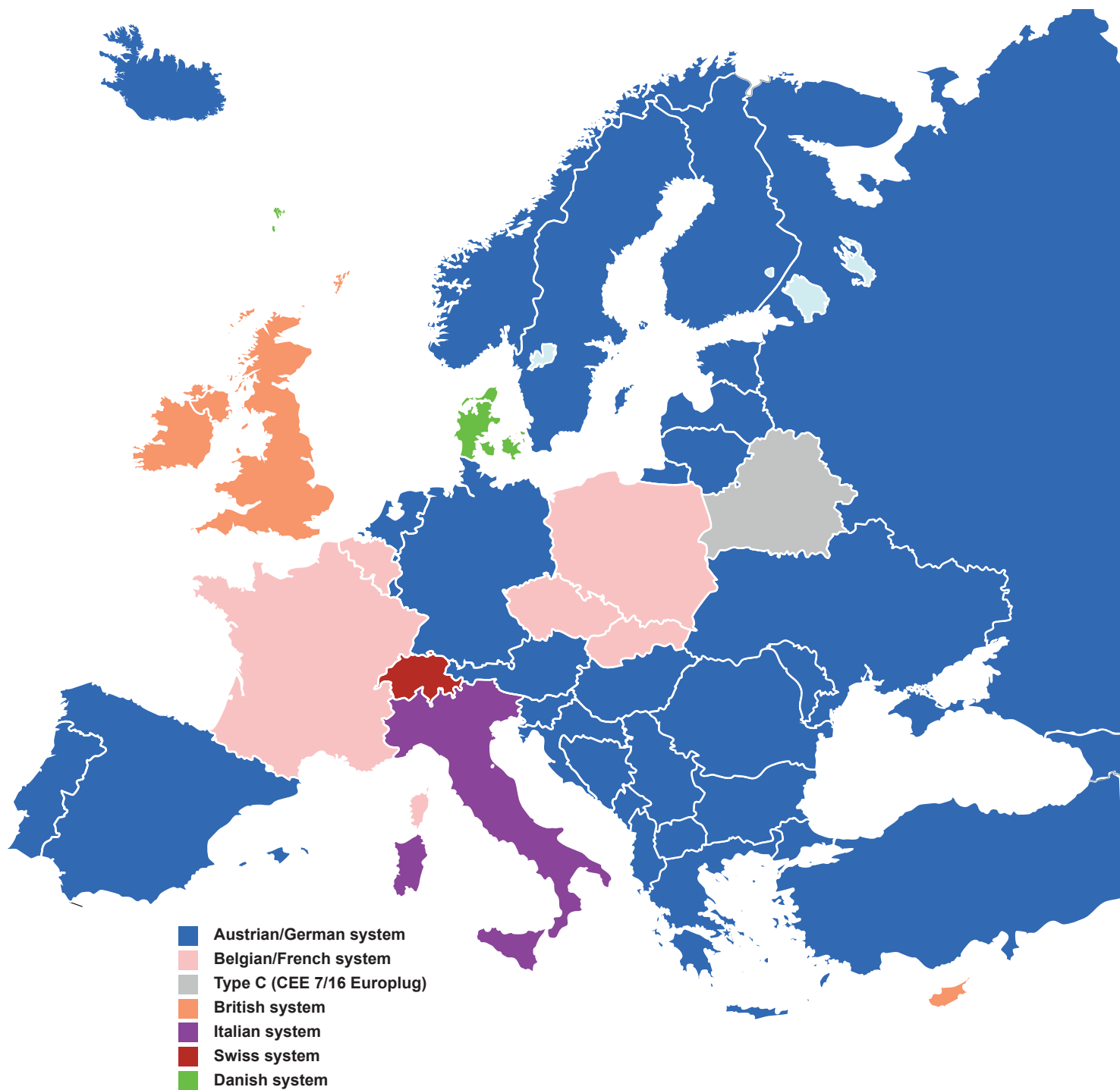

## Order information:

Safety sockets are available in grey, red, yellow, black and white (blau = standard)

**P-Nova:** Special versions are available on request, e.g.: with side connection and child protection (shutter)

Minimum quantity for ordering special versions: 1.000 pieces



# Socket outlets

Dimensions:

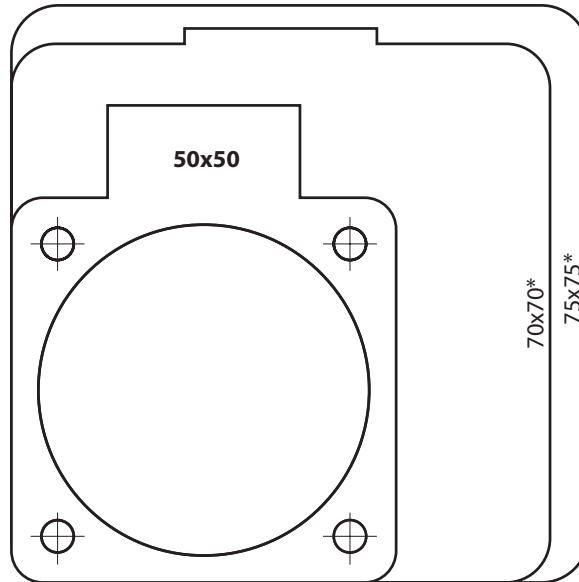

\* only P-NOVA

Versions: (Flange: 50 x 50)

	Screw terminals	Screwless connection	Side connection	Rear connection	Child protection (shutter)	Sealing bulge**				
	●		●							
							<b>Austrian/German system</b>		<b>Belgian/French system</b>	
	●		●		●		<b>1050-0bs</b>	<b>105-0bs</b>	<b>1040-0bs</b>	<b>104-0bs</b>
	●		●		●		<b>1050-0bsc</b>	<b>105-0bsc</b>	<b>1040-0bsc</b>	<b>104-0bsc</b>
	●			●			<b>1050-0b</b>	<b>105-0b</b>	<b>1040-0b</b>	<b>104-0b</b>
	●			●	●		<b>1050-0bc</b>	<b>105-0bc</b>	<b>1040-0bc</b>	<b>104-0bc</b>
	●			●		●	<b>1050-0bw</b>	<b>105-0bw</b>		
		●		●				<b>109-0b</b>		<b>108-0b</b>
		●		●	●			<b>109-0bc</b>		<b>108-0bc</b>
		●		●		●		<b>109-0bw</b>		

\*\* Plugs and socket outlets (DIN 49440) for portable use subject to the standard  
DIN VDE 0620-1:2010 and ÖVE/ÖNORM EA 8684-2-2:2010



**Socket outlet Austrian/German system**

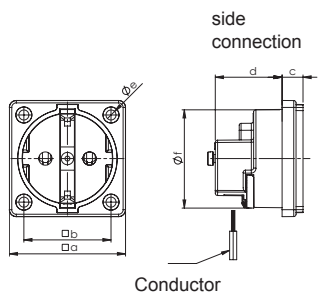

• STANDARD •	
	16 Amp
Poles	2P + E
a	50
b	37,5
c	9
d	29
e	4,3
f	43
Connection type:	Screwed contact
Wire flexible [mm <sup>2</sup> ]	1 - 2x2,5
solid [mm <sup>2</sup> ]	1 - 2x2,5
Contact screws [Ncm]	80
Weight [g]	34

- with screw terminals
- housing material: PA6
- contacts: nickel-plated contacts

**IP20**



**Socket outlet Austrian/German system**

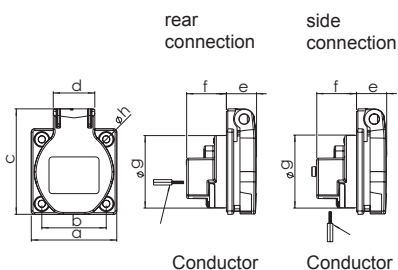

• STANDARD •	
	16 Amp
Poles	2P + E
a	50
b	38
c	62
d	25
e	18
f	24
g	43
h	4,2
Connection type:	Screwed contact
Wire flexible [mm <sup>2</sup> ]	1 - 2x2,5
solid [mm <sup>2</sup> ]	1 - 2x2,5
Contact screws [Ncm]	80
Weight [g]	45

- with screw terminals
- housing material: PA6
- contacts: nickel-plated contacts

**IP54** splashproof



**Socket outlet Austrian/German system**

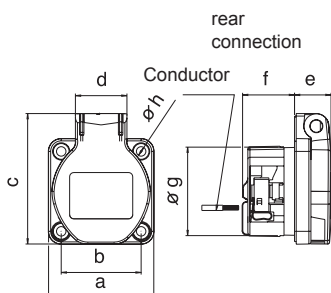

	• STANDARD •		• SPECIAL •	
	16 Amp	16 Amp	16 Amp	16 Amp
Poles	2P + E	2P + E	2P + E	2P + E
a	50	70	75	75
b	38	56	60	60
c	62	72	75	75
d	25	25	25	25
e	17	17	17	17
f	26	26	26	26
g	43	43	43	43
h	4,2	5,5	5,5	5,5
Connection type:	Screwless			
Wire flexible [mm <sup>2</sup> ]	1 - 2x2,5			
solid [mm <sup>2</sup> ]	1 - 2x2,5			
Weight [g]	43	48	49	49

- screwless connection technology
- housing material: PA6
- contacts: nickel-plated contacts
- rear connection

**IP54** splashproof



**Socket outlet Austrian/German system**

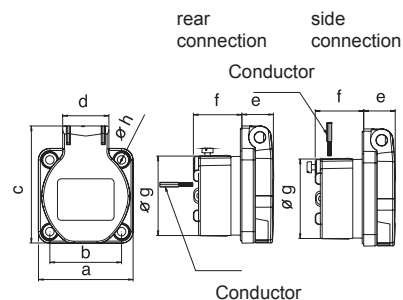

	• STANDARD •		• SPECIAL •	
	16 Amp	16 Amp	16 Amp	16 Amp
Poles	2P + E	2P + E	2P + E	2P + E
a	50	70	75	75
b	38	56	60	60
c	62	72	75	75
d	25	25	25	25
e	17	17	17	17
f	26	26	26	26
g	43	43	43	43
h	4,2	5,5	5,5	5,5
Connection type:	Screwed contact			
Wire flexible [mm <sup>2</sup> ]	1 - 2x2,5			
solid [mm <sup>2</sup> ]	1 - 2x2,5			
Contact screws [Ncm]	80			
Weight [g]	45	50	51	51

- with screw terminals
- housing material: PA6
- contacts: nickel-plated contacts

**IP54** splashproof







STANDARD

SPECIAL

SPECIAL

250V~  
50/60Hz  
Flange  
50x50250V~  
50/60Hz  
Flange  
70x70250V~  
50/60Hz  
Flange  
75x75

PCE

Amp.	Poles	pack. unit	Abbreviations/Types	Cat.No.	Cat.No.	Cat.No.
------	-------	------------	---------------------	---------	---------	---------

16	3	100				
----	---	-----	--	--	--	--



„SC“ side connection, with child protection (shutter)

10584-0wsc



10584-0wsc

16	3	100				
16	3	100				
16	3	100				
16	3	100				



rear connection (standard)

1050-0b

„S“ side connection

1050-0bs

„C“ rear connection, with child protection (shutter)

1050-0bc

„SC“ side connection, with child protection (shutter)

1050-0bsc



1050-0b

16	3	100				
16	3	100				



rear connection (standard)

109-0b

109-7b

109-8b

„C“ rear connection, with child protection (shutter)

109-0bc

109-7bc

109-8bc

109-0b  
Flange = 50x50109-8b  
Flange = 75x75

16	3	100				
16	3	100				
16	3	100				
16	3	100				



rear connection (standard)

105-0b

105-7b

105-8b

„S“ side connection

105-0bs

105-7bs

105-8bs

„C“ rear connection, with child protection (shutter)

105-0bc

105-7bc

105-8bc

„SC“ side connection, with child protection (shutter)

105-0bsc

105-7bsc

105-8bsc

105-0b  
Flange = 50x50

Special versions are available on request. For more information about our ordering system, please have a look on page 148.

Minimum order quantity for special versions: 1.000 pieces





## Plugs and socket outlets

# Flanged sockets conforming to Austrian/German system for portable use

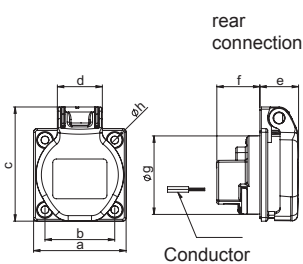

### Socket outlet Austrian/German system

	• STANDARD •
	16 Amp
Poles	2P + E
a	50
b	38
c	62
d	25
e	22
f	24
g	43
h	4,2
Connection type:	Screwed contact
Wire flexible [mm <sup>2</sup> ]	1 - 2x2,5
solid [mm <sup>2</sup> ]	1 - 2x2,5
Contact screws [Ncm]	80
Weight [g]	45

- with sealing bulge
- with screw terminals
- housing material: PA6
- contacts: nickel-plated contacts

**IP54** splashproof

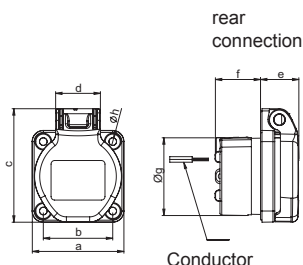

### Socket outlet Austrian/German system

	•STANDARD•	• SPECIAL •	
	16 Amp	16 Amp	
Poles	2P + E	2P +E	2P + E
a	50	70	75
b	38	56	60
c	62	72	75
d	25	25	25
e	21	21	21
f	26	26	26
g	43	43	43
h	4,2	5,5	5,5
Connection type:		Screwless	
Wire flexible [mm <sup>2</sup> ]		1 - 2x2,5	
solid [mm <sup>2</sup> ]		1 - 2x2,5	
Weight [g]	44	49	50

- with sealing bulge
- screwless connection technology
- housing material: PA6
- contacts: nickel-plated contacts

**IP54** splashproof

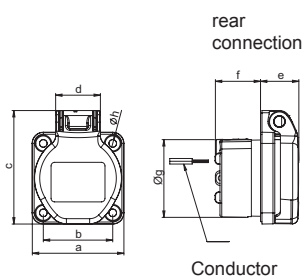

### Socket outlet Austrian/German system

	•STANDARD•	• SPECIAL •	
	16 Amp	16 Amp	
Poles	2P + E	2P +E	2P + E
a	50	70	75
b	38	56	60
c	62	72	75
d	25	25	25
e	21	21	21
f	26	26	26
g	43	43	43
h	4,2	5,5	5,5
Connection type:		Screwed contact	
Wire flexible [mm <sup>2</sup> ]		1 - 2x2,5	
solid [mm <sup>2</sup> ]		1 - 2x2,5	
Weight [g]	46	51	52

- with sealing bulge
- with screw terminals
- housing material: PA6
- contacts: nickel-plated contacts

**IP54** splashproof



■ ■ Plugs and socket outlets for portable use are subject to the standard DIN VDE 0620-1:2010 and ÖVE/ÖNORM EA 8684-2-2:2010 (Plugs and sockets for household and similar applications).  
Examples for portable use: mobile distribution boxes and cable reels.

Remark: Version for Germany and Austria

**250V~**  
 50/60Hz  
 Flange  
**50x50**
**250V~**  
 50/60Hz  
 Flange  
**70x70**
**250V~**  
 50/60Hz  
 Flange  
**75x75**

Amp.	Poles	pack. unit	Abbreviations/Types	Cat.No.	Cat.No.	Cat.No.
------	-------	------------	---------------------	---------	---------	---------

16	3	100	 rear connection, with sealing bulge	1050-0bw		
----	---	-----	--	----------	--	--



1050-0bw

16	3	100	 rear connection, with sealing bulge	109-0bw	109-7bw	109-8bw
----	---	-----	--	---------	---------	---------



109-0bw

16	3	100	 rear connection, with sealing bulge	105-0bw	105-7bw	105-8bw
----	---	-----	--	---------	---------	---------



105-0bw

**Explanation:**

The prescribed standard of the sealing bulge is highlighted in red in the picture below.



# Flanged sockets conforming to Belgian/French system

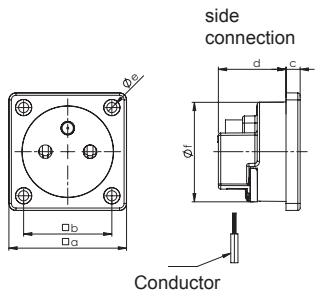

## Socket outlet Belgian/French system

• STANDARD •	
	16 Amp
Poles	2P + E
a	50
b	37,5
c	6
d	29
e	4,3
f	43
Connection type:	Screwed contact
Wire flexible [mm <sup>2</sup> ]	1 - 2x2,5
solid [mm <sup>2</sup> ]	1 - 2x2,5
Contact screws [Ncm]	80
Weight [g]	34

- with screw terminals
- housing material: PA6
- contacts: nickel-plated contacts

IP20

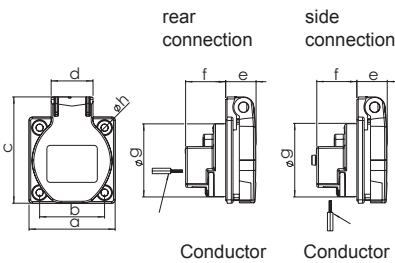

## Socket outlet Belgian/French system

• STANDARD •	
	16 Amp
Poles	2P + E
a	50
b	38
c	62
d	25
e	18
f	24
g	43
h	4,2
Connection type:	Screwed contact
Wire flexible [mm <sup>2</sup> ]	1 - 2x2,5
solid [mm <sup>2</sup> ]	1 - 2x2,5
Contact screws [Ncm]	80
Weight [g]	45

- with screw terminals
- housing material: PA6
- contacts: nickel-plated contacts

IP54 splashproof

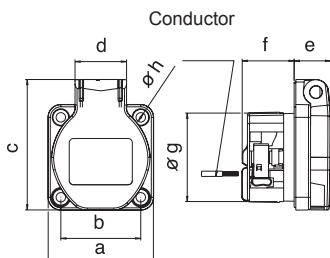

## Socket outlet Belgian/French version

	• STANDARD •		• SPECIAL •	
	16 Amp		16 Amp	
Poles	2P + E	2P + E	2P + E	2P + E
a	50	70	75	75
b	38	56	60	60
c	62	72	75	75
d	25	25	25	25
e	17	17	17	17
f	26	26	26	26
g	43	43	43	43
h	4,2	5,5	5,5	5,5
Connection type:	Screwless			
Wire flexible [mm <sup>2</sup> ]	1 - 2x2,5			
solid [mm <sup>2</sup> ]	1 - 2x2,5			
Weight [g]	43	48	49	49

- screwless connection technology
- housing material: PA6
- contacts: nickel-plated contacts
- rear connection

IP54 splashproof

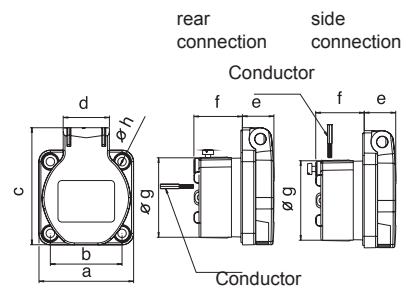

## Socket outlet Belgian/French version

	• STANDARD •		• SPECIAL •	
	16 Amp		16 Amp	
Poles	2P + E	2P + E	2P + E	2P + E
a	50	70	75	75
b	38	56	60	60
c	62	72	75	75
d	25	25	25	25
e	17	17	17	17
f	26	26	26	26
g	43	43	43	43
h	4,2	5,5	5,5	5,5
Connection type:	Screwed contact			
Wire flexible [mm <sup>2</sup> ]	1 - 2x2,5			
solid [mm <sup>2</sup> ]	1 - 2x2,5			
Contact screws [Ncm]	80			
Weight [g]	45	50	51	51

- with screw terminals
- housing material: PA6
- contacts: nickel-plated contacts

IP54 splashproof

STANDARD

SPECIAL

SPECIAL

**250V~**  
 50/60Hz  
 Flange  
**50x50**
**250V~**  
 50/60Hz  
 Flange  
**70x70**
**250V~**  
 50/60Hz  
 Flange  
**75x75**



# PCE

Amp.	Poles	pack. unit	Abbreviations/Types	Cat.No.	Cat.No.	Cat.No.
------	-------	------------	---------------------	---------	---------	---------

16	3	100	 „sc“ side connection, with child protection (shutter) color: white	10484-0wsc		
----	---	-----	--	------------	--	--





10484-0wsc



16	3	100	 <b>rear connection (standard)</b>	1040-0b		
16	3	100	„S“ side connection	1040-0bs		
16	3	100	„C“ with child protection (shutter)	 1040-0bc		
16	3	100	„sc“ side connection, with child protection (shutter)	 1040-0bsc		



1040-0b

16	3	100	 <b>rear connection (standard)</b>	108-0b	108-7b	108-8b
16	3	100	„C“ with child protection (shutter)	 108-0bc	108-7bc	108-8bc

108-0b  
Flange = 50x50

16	3	100	 <b>rear connection (standard)</b>	104-0b	104-7b	104-8b
16	3	100	„S“ side connection	104-0bs	104-7bs	104-8bs
16	3	100	„C“ with child protection (shutter)	 104-0bc	104-7bc	104-8bc
16	3	100	„sc“ side connection, with child protection	 104-0bsc	104-7bsc	104-8bsc

104-0b  
Flange = 50x50

Special versions are available on request. For more information about our ordering system, please have a look on page 148.

Minimum quantity for ordering special versions: 1.000 pieces





## Plugs and socket outlets

### Flanged sockets conforming to Danish, English and Swiss system

#### Socket outlet Danish system

Poles	16 Amp	2P + E
a	50	
b	38	
c	60	
d	24,5	
e	15	
f	30	
g	43	
h	4,2	
Connection type:	Screwed contact	
Weight [g]	42	

- with screw terminals
- housing material: PA6
- contacts: nickel-plated contacts

**IP44** splashproof 



#### Socket outlet English version

Poles	13 Amp	13 Amp
	2P + E	2P + E
a	64	50
b	52	38
c	72	64
d	25	25
e	26,5	18
f	18	22
g	52	35
h	4,2	4,5
Connection type:	Screwed contact	
Weight [g]	67	50

- with screw terminals
- housing material: PA6

**IP54** splashproof 



#### Socket outlet Swiss version T13

Poles	10 Amp	2P + E
a	50	
b	38	
c	62	
d	29	
e	15	
f	23	
g	42	
h	4,2	
Connection type:	Screwed contact	
Weight [g]	42	

- with screw terminals
- housing material: PA6
- contacts: nickel-plated contacts

**IP54** splashproof



#### Socket outlet Swiss version T23

Poles	16 Amp	2P + E
a	50	
b	38	
c	60	
d	25	
e	15	
f	24	
g	42	
h	4,2	
Connection type:	Screwed contact	
Weight [g]	42	

- with screw terminals
- housing material: PA6
- contacts: nickel-plated contacts

**IP54** splashproof



#### Socket outlet Swiss version T25

Poles	16 Amp	3L + N + PE
a	50	
b	38	
c	60	
d	25	
e	24	
f	31	
g	43	
h	4,2	
Connection type:	Screwed contact	
Weight [g]	64	

- with screw terminals
- housing material: PA6
- contacts: nickel-plated contacts
- 250V/400V~ 16A

**IP54** splashproof

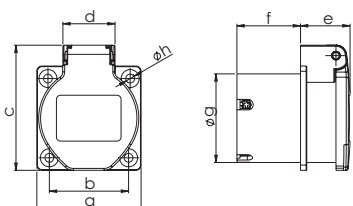
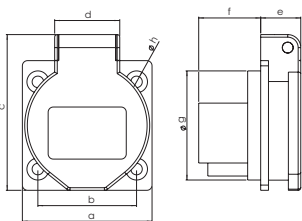
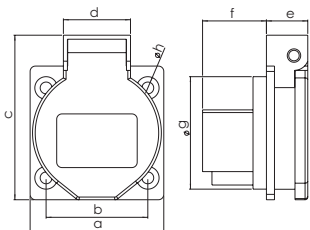
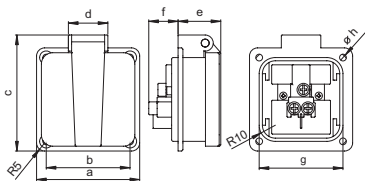
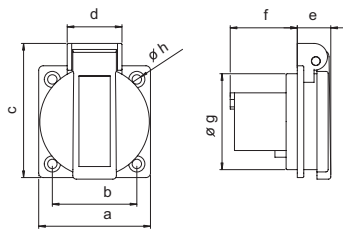

250V~

50/60Hz

400V~

50/60Hz

Amp.	Poles	pack. unit	Abbreviations/Types	Cat.No.	Cat.No.		
16	3	100	rear connection Flange: 50 x 50	1030-0b	blue		
16	3	100	rear connection Flange: 50 x 50	1030-0s	black		
13	3	100	side connection Flange: 64 x 64	1020-0s	black		
13	3	100	side connection Flange: 50 x 50	1020-5s	black		
10	3	100	rear connection Flange: 50 x 50	1013-0b	blue		
16	3	100	side connection Flange: 50 x 50	1023-0bs	blue		
16	5	100	rear connection Flange: 50 x 50	1025-0r	red		

# Plugs and socket outlets

## Data socket outlets and accessories

### Data socket outlet

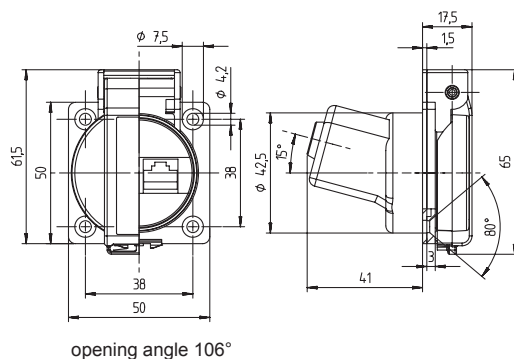

- 2xRJ45 Cat.6 Modul 8(8)
- with insulation displacement connection

**IP55** dust- and waterproof

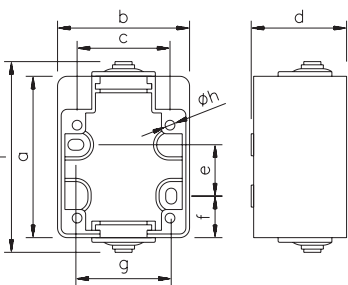

### Mounting box

a	66
b	54
c	38
d	39
e	21
f	17
g	39
h	3
i	78
Weight [g]	43

- for sockets PNOVA Plus with lid and flange size 50 x 50 mm
- suitable also for Swiss socket T23 1023-0bs and for Danish socket 1030-0b

**IP44** splashproof

#### Advantages:

- easy mounting - long holes for screws
- hole distance dimensions - on the rear
- space between wall and box by nipples
- 2 entries for PG 13,5
- holes for dehydration available

### Flange gasket for P-Nova+

- for flange 50x50mm

Flange gasket can be mounted additionally if required. (e.g.: for uneven surfaces)

### Flange gasket for P-Nova

- for flange 50x50mm

Flange gasket can be mounted additionally if required. (e.g.: for uneven surfaces)

16 3 10 yellow

45k23

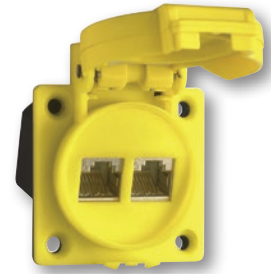

16 3 24 blue  
16 3 24 grey

106-0  
106-0g

**Fields of application:**  
designed for use in workshop halls, garages, industrial plants, outside walls, ...  
Mounting box is supplied complete.



106-0



Version: Flange gasket for P-Nova+

d105-05

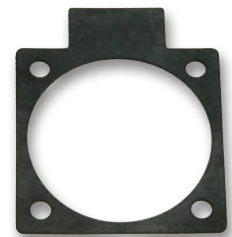

Version: Flange gasket for P-Nova

d105-0





# NAUTILUS



**WATERTIGHT  
PLUGS AND CONNECTORS IP66/68**

## Watertight Plugs and Sockets IP66/68

- robust design
-  for severe conditions
- housing material PC/ABS
- IP66/68 waterproof up to 2 bar / 2 h
- cover with bayonet
- very large hinged lid opening angle (~160°)
- contact-supporting part of PA6, glow wire test 850°C
- open contact screw head +/-
- nickel-plated screw terminals
- cover and cap with elastic band
- axels and mounting screws in stainless V2A quality
- two earthing system (plug)
- screwless cable gland (plug/connector)



Austrian/German system  
with/without shutter



Belg./French system  
with/without shutter

### Plug/Connector

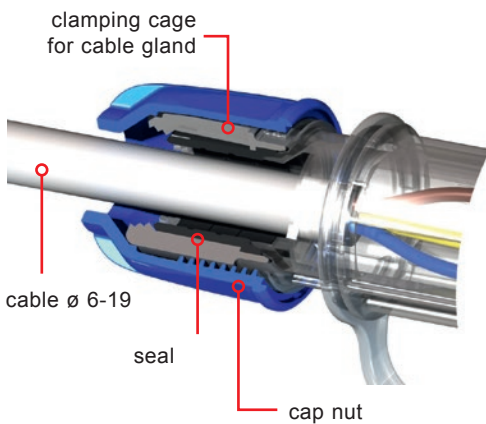

### Plug

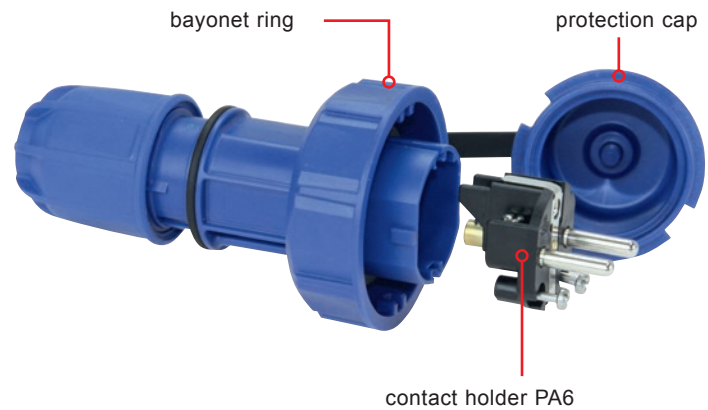

### Flanged socket

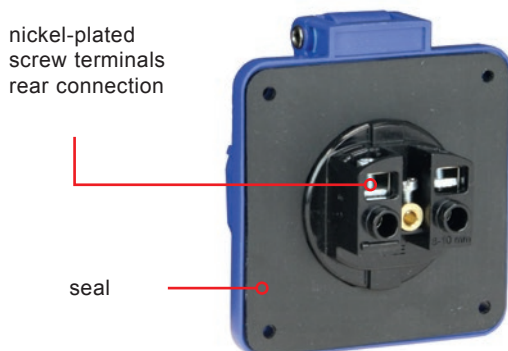

### Connector

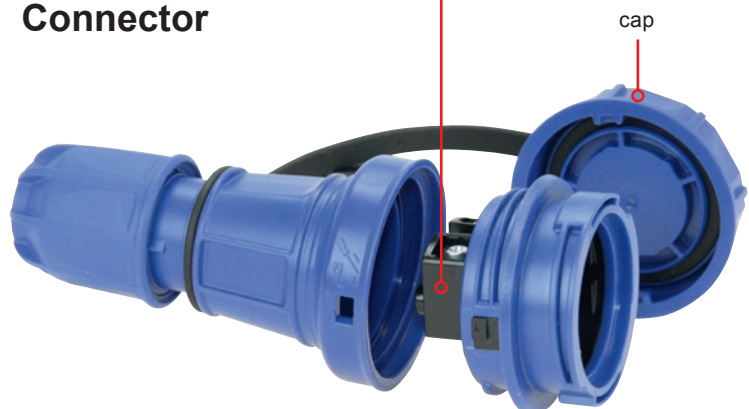



## Watertight plugs and connectors IP66/68

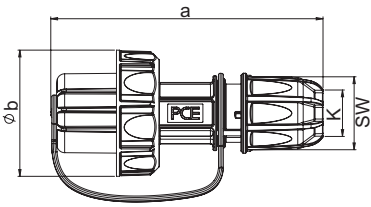

### Plug with protection cap IP66/68

	16 Amp
Poles	2P + E
a	144
Ø b	65
K (cable Ø)	6 - 19
SW	38
Connection type:	Screwed contact
Wire flexible [mm <sup>2</sup> ]	1 - 2,5
Contact screws [Ncm]	100
Weight [g]	120

- with screw terminals
- housing material: PC/ABS
- contacts: nickel-plated
- protection cap with band

**IP66/68** watertight  
up to 2 bar / 2h

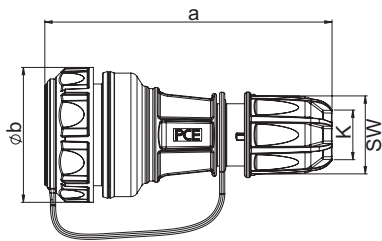

### Connector with cap IP66/68

	16 Amp
Poles	2P + E
a	140
Ø b	65
K (cable Ø)	6 - 19
SW	38
Connection type:	Screwed contact
Wire flexible [mm <sup>2</sup> ]	1 - 2,5
Contact screws [Ncm]	100
Weight [g]	140

- with screw terminals
- housing material: PC/ABS
- contacts: nickel-plated
- cap with band

**IP66/68** watertight  
up to 2 bar / 2h



250V~  
50/60Hz

Amp. Poles pack. unit Abbreviations/Types Cat.No.

16	3	10	<p><b>Austr./German system + Belg./French system</b></p> <p>2-earthing systems</p>	20051-b
----	---	----	--	---------

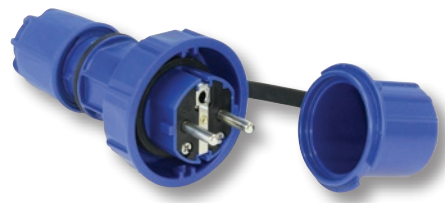

20051-b

16	3	10	<b>Austr./German system</b>	20251-b
16	3	10	without child protection (shutter)	20251-bc
16	3	10	with child protection (shutter)	
16	3	10	<b>Belg./French system</b>	20241-b
16	3	10	without child protection (shutter)	20241-bc
16	3	10	with child protection (shutter)	



20051-b





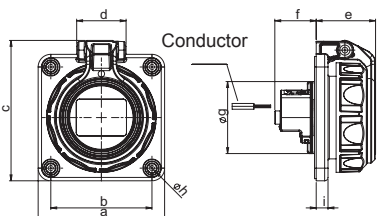

### Flanged socket with hinged lid

	16 Amp
Poles	2P + E
a	75
b	60
c	84
d	30
e	36
f	25
g	43
h	5,5
i	7
Connection type:	Screwed contact
Wire flexible [mm <sup>2</sup> ]	1 - 2x2,5
solid [mm <sup>2</sup> ]	1 - 2x2,5
Contact screws [Ncm]	80
Weight [g]	-

- with screw terminals
- housing material: PC/ABS
- contacts: nickel-plated contacts
- rear connection
- 4-point fastening

**IP66/68** watertight up to 2 bar / 2h

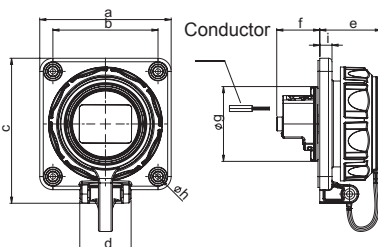

### Flanged socket with cover band

	16 Amp
Poles	2P + E
a	75
b	60
c	84
d	30
e	36
f	25
g	43
h	5,5
i	7
Connection type:	Screwed contact
Wire flexible [mm <sup>2</sup> ]	1 - 2x2,5
solid [mm <sup>2</sup> ]	1 - 2x2,5
Contact screws [Ncm]	80
Weight [g]	-

- with screw terminals
- housing material: PC/ABS
- contacts: nickel-plated contacts
- rear connection
- 4-point fastening

**IP66/68** watertight up to 2 bar / 2h

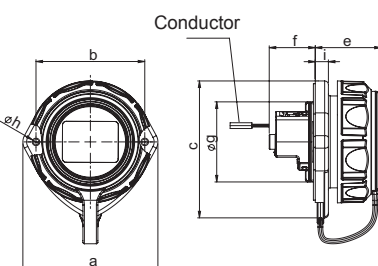

### Flanged socket oval with cover band

	16 Amp
Poles	2P + E
a	72
b	58
c	75
e	36
f	25
g	43
h	4
i	7
Connection type:	Screwed contact
Wire flexible [mm <sup>2</sup> ]	1 - 2x2,5
solid [mm <sup>2</sup> ]	1 - 2x2,5
Contact screws [Ncm]	80
Weight [g]	-

- with screw terminals
- housing material: PC/ABS
- contacts: nickel-plated contacts
- rear connection
- 2-point fastening

**IP66/68** watertight up to 2 bar / 2h



### ■ Opening and closing:

When opening the hinged lid it latches into a defined position which prevents the lid when closing in a half position (Fig.1) on the housing. The open and closed position is visible by the position of the silver label to make sure, that the socket is closed all the way to be watertight.

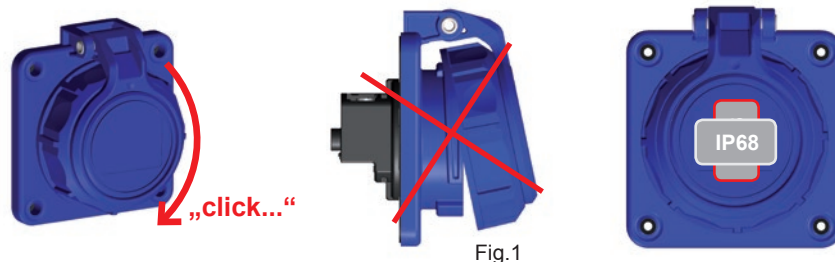

Fig.1

Labelling field horizontal =>

cover waterproof closed

IP68

Labelling field vertical =>

cover not closed correctly (not seal)

IP68

250V~  
50/60Hz

Amp.	Poles	pack. unit	Abbreviations/Types	Cat.No.
16	3	10	<b>Austrian/German system</b> rear connection, flange 75x75	20352-8b
16	3	10	„C“ rear connection, flange 75x75, with child protection (Shutter)	20352-8bc
16	3	10	<b>Belg./French system</b> rear connection, flange 75x75	20342-8b
16	3	10	„C“ rear connection, flange 75x75, with child protection (Shutter)	20342-8bc



20342-8b

16	3	10	<b>Austrian/German system</b> rear connection, flange 75x75	20351-8b
16	3	10	„C“ rear connection, flange 75x75, with child protection (Shutter)	20351-8bc
16	3	10	<b>Belg./French system</b> rear connection, flange 75x75	20341-8b
16	3	10	„C“ rear connection, flange 75x75, with child protection (Shutter)	20341-8bc



20341-8b

16	3	10	<b>Austrian/German system</b> rear connection, oval flange	20351-9b
16	3	10	„C“ rear connection, oval flange with child protection (Shutter)	20351-9bc
16	3	10	<b>Belg./French system</b> rear connection, oval flange	20341-9b
16	3	10	„C“ rear connection, oval flange with child protection (Shutter)	20341-9bc



20351-9b

■ Screw head seal:

Plastic bed „A“ acts as an additional screw head seal to prevent water entering through the screw head.

Flange gasket (seal) „B“ additionally prevents water entering through the threaded shaft of the screw.



A



B





## PLUGS

- IP44
-  for severe conditions
- 16A 250V~
- rubber and solid rubber
- single and dual-point earthing system



Rubber



Solid rubber

easy assembly and disassembly  
of the contact carriers

---

large connection area

---

time saving installation

simple handling

---

robust design

---

easy disassembly of shroud

---

slim design



## PLUG SYSTEMS

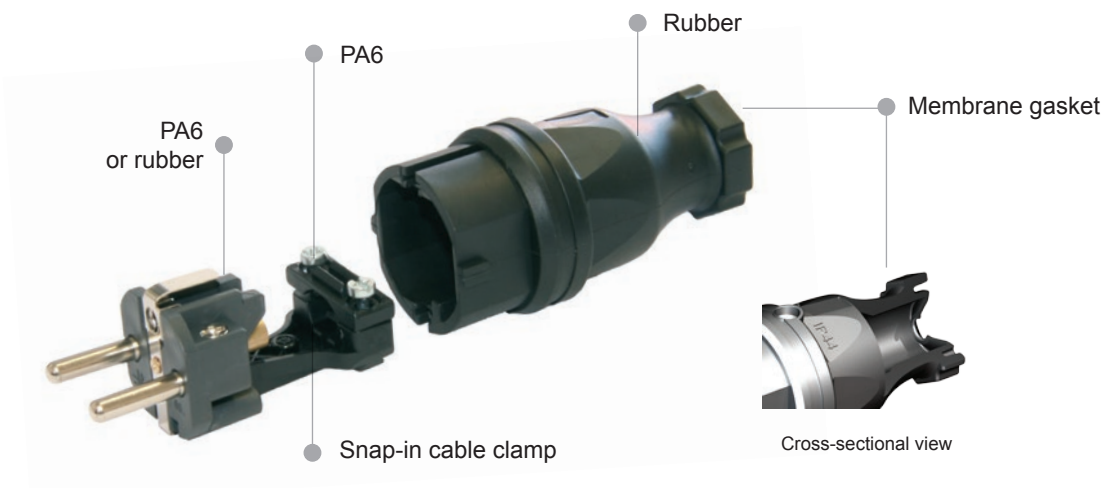

Max. 3G2,5 mm<sup>2</sup> rubber-sheathed flexible cable

CONNECTOR SYSTEMS



PLUG MODULES

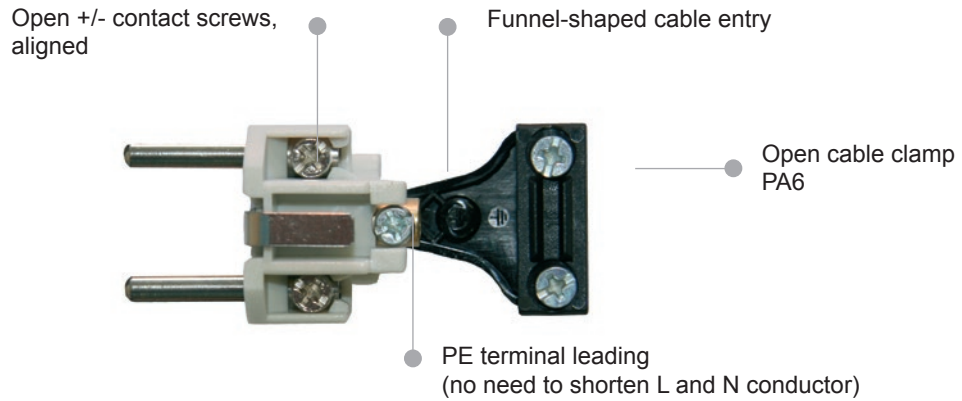

CONNECTOR SYSTEMS

- IP44
- for severe conditions
- 16A 250V~
- rubber and solid rubber
- dual-point earthing system

Rubber connector Belgian/French earth

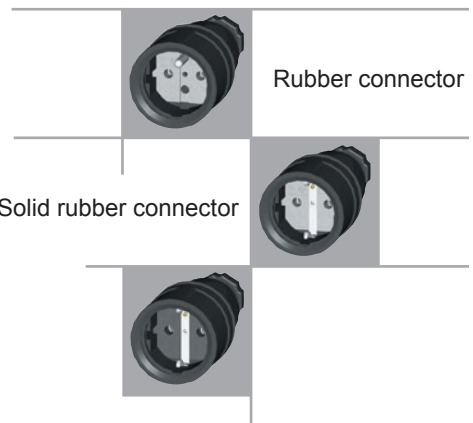

Rubber



Connector with hinged lid



Connector with interlocked ring

**Cable clamp:**

internal  
easy to use cable clamp elements  
(open screws)

large connection area  
simple initial assembly via  
notched contact carriers

**Contact and connection system:**

all contact screws can be adjusted from a single direction (parallel alignment).







SERIES

**TAURUS**

**PLUG AND CONNECTOR SYSTEMS**



## CONNECTOR MODULES

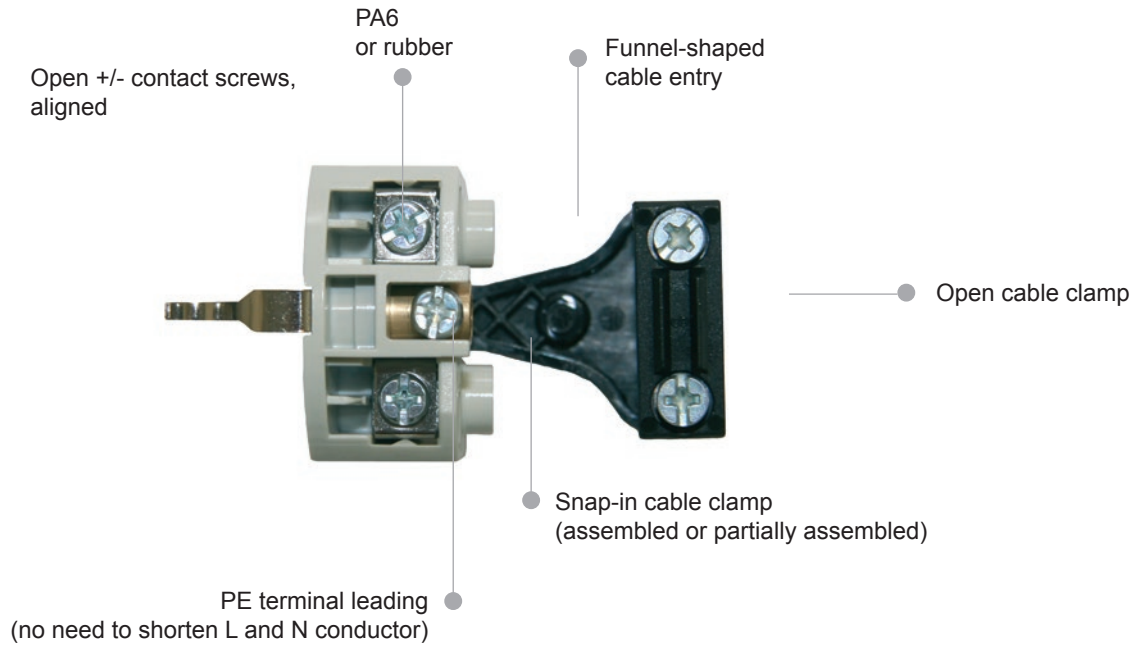

Max. 3G2,5 mm<sup>2</sup> rubber-sheathed flexible cable



## 3-WAY CONNECTORS

- IP44
-  for severe conditions
- 16A 250V
- rubber and solid rubber

contact carriers integrated in housing

own contact elements

open cable clamp

Separate assembly area  
Connection at terminals



Cap with band

# Safety plugs

## Rubber plug IP44

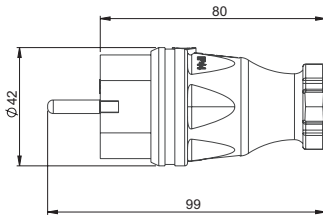

• Insert: polyamide

IP44 splashproof



Insert:	acc. Austrian/German system	dual earthing system	acc. Belg./French System
Polyamide	0511-s	0521-s	0531-s
pack.unit:	30	30	30

## Solid rubber plug IP44

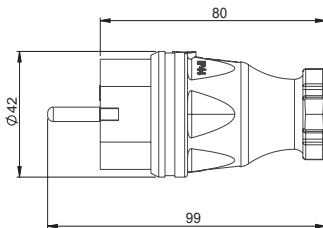

• Insert: rubber

IP44 splashproof



Insert:	acc. Austrian/German system	dual earthing system	acc. Belg./French System
Rubber	0512-s	0522-s	0532-s
pack.unit:	30	30	30

## Angled plug (rubber / solid rubber) IP44

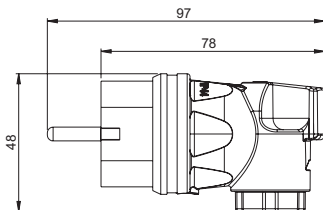

IP44 splashproof



Insert:	acc. Austrian/German system	dual earthing system	acc. Belg./French System
Polyamide	05811-s	05821-s	05831-s
Rubber	05812-s	05822-s	05832-s
pack.unit	30	30	30



## Rubber connector IP20

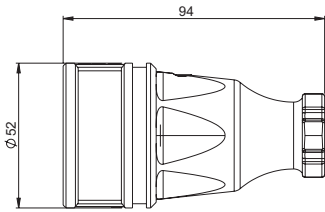

- Insert: polyamide

**IP20**



Insert:	acc. Austrian/German system	acc. Belg./French System
Polyamide	<b>2510-s</b>	2410-s
Polyamide with child protection	<b>2510-sc</b>	2410-sc
pack.unit	20	20



## Solid rubber connector IP20

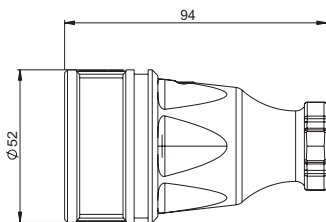

- Insert: rubber



Insert:	acc. Austrian/German system	
Rubber	<b>2520-s</b>	
pack.unit	20	

## Rubber connector with cap IP44

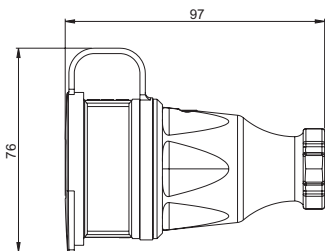

- with cap
- Insert: polyamide

**IP44** splashproof 



Insert:	acc. Austrian/German system	acc. Belg./French System
Polyamide	2511-s	2411-s
Polyamide with child protection	2511-sc	2411-sc
pack.unit	20	20



# Safety connectors

## Solid rubber connector with cap IP44

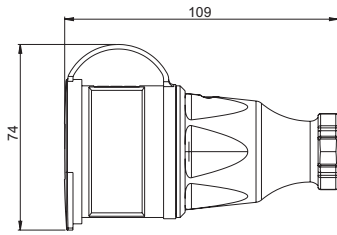

• Insert: rubber

IP44 splashproof 



Insert:	acc. Austrian/German system	
Rubber	2521-s	
pack.unit	20	

## Solid rubber connector with hinged lid IP44

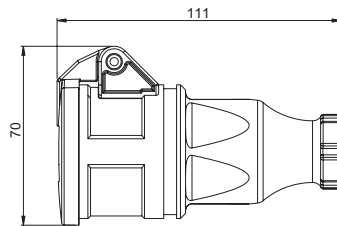

• Insert: rubber

IP44 splashproof 



Insert:	acc. Austrian/German system	
Rubber	2522-s	
pack.unit	20	

## Rubber connector with cap and locking ring IP44

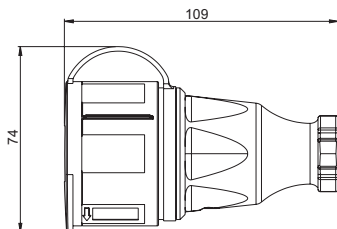

• With cap and locking ring  
• Insert: polyamide

IP44 splashproof 



Insert:	acc. Austrian/German system	acc. Belg./French System
Polyamide	2511-sl	2411-sl
Polyamide with child protection	2511-scl	2411-scl
VPE	20	20





### 3-way connector rubber with cap\* IP44

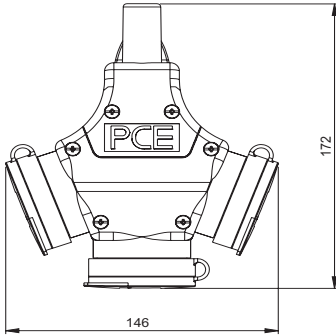

- with cap
- Insert: polyamide

IP44 splashproof 



Insert:	acc. Austrian/German system	acc. Belg./French System
Polyamide	25311-s	24311-s
Polyamide with child protection	25311-sc	24311-sc
pack.unit	5	5



\* 3-way connectors with hinged lid see page 177

### 3-way connector rubber with cap\* and 5-pole connector IP44



- 5-pole connector terminal
- With cap
- Insert: polyamide

IP44 splashproof 



Insert:	acc. Austrian/German system	acc. Belg./French System
Polyamide	25311-s5	24311-s5
Polyamide with child protection		24311-sc5
pack.unit	5	5



\* 3-way connectors with hinged lid see page 177

## Safety plugs and sockets POLYAMIDE

### 2-way connector with hinged lid IP44

- With hinged lid
- Insert: polyamide

IP44 splashproof

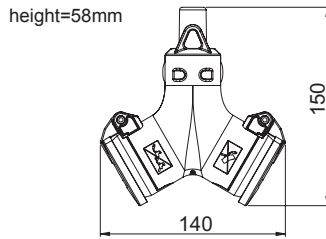

Insert:	acc. Austrian/German system	acc. Belg./French System
Polyamide	25212-r	24212-r
Polyamide with child protection	25212-rc	24212-rc
pack.unit	10	10

## Safety plugs and connectors

Polyamide

### Plug

- Polyamide

IP20

Color	pack. unit	acc. Austrian/German system		dual earthing system
		cable entry central	cable entry side	cable entry central
white	50	02958	05018	08266
brown	50	02961	05021	08282
black	50	02974	05034	08295
grey	50	02980	05040	



### Connecor

- Polyamide

IP20

Color	pack. unit	acc. Belg./Franz. system	
white	25	05148	08224
brown	25	05164	
black	25	05177	08253
grey	25	05180	



## Plug British system 13A

### Plug

- Polyamide
- With integrated 13A fuse
- Cable entry: side

IP32

Color	pack unit.	acc. brit. system
		cable entry side
black	10	00200





### PLUG & CONNECTOR

- IP44
-  for severe conditions
- 16A 250V~
- only solid rubber
- screwless cable gland
- perfect grip
- plug: dual earthing system
- connector: two earthing systems (Austrian/German system, Belg./French system)

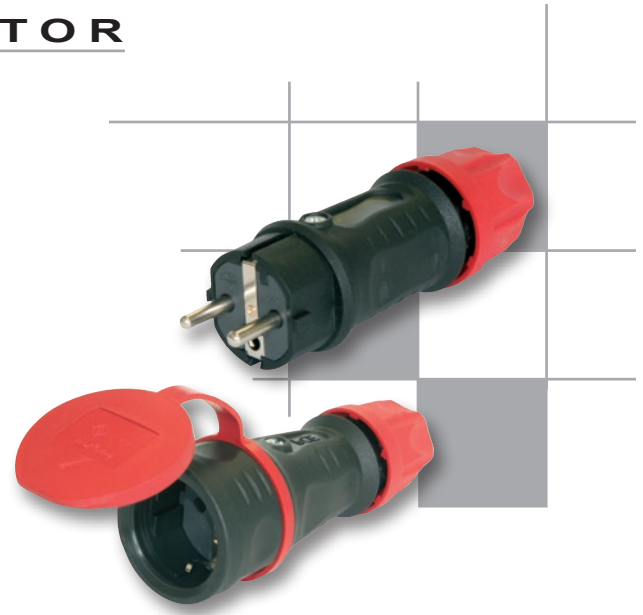

easy assembly and disassembly of the contact carriers

time saving (shorter connection time) due to the external cable clamp

large connection area

simple handling

robust design

up to 3G 2,5mm<sup>2</sup>



### PLUG MODULES

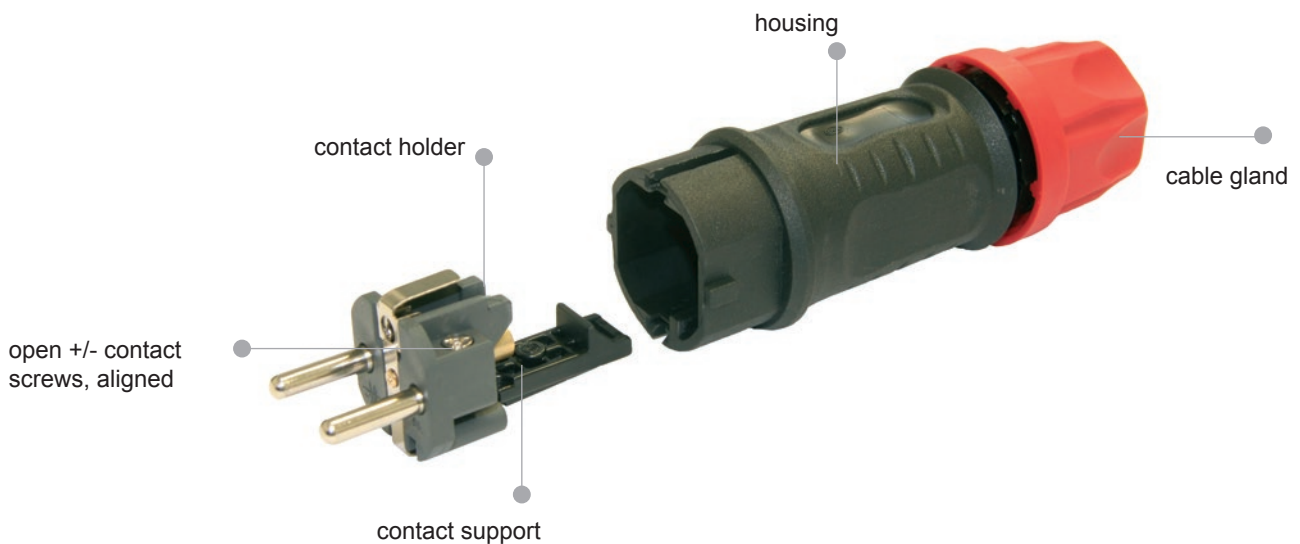



## CONNECTOR MODULES

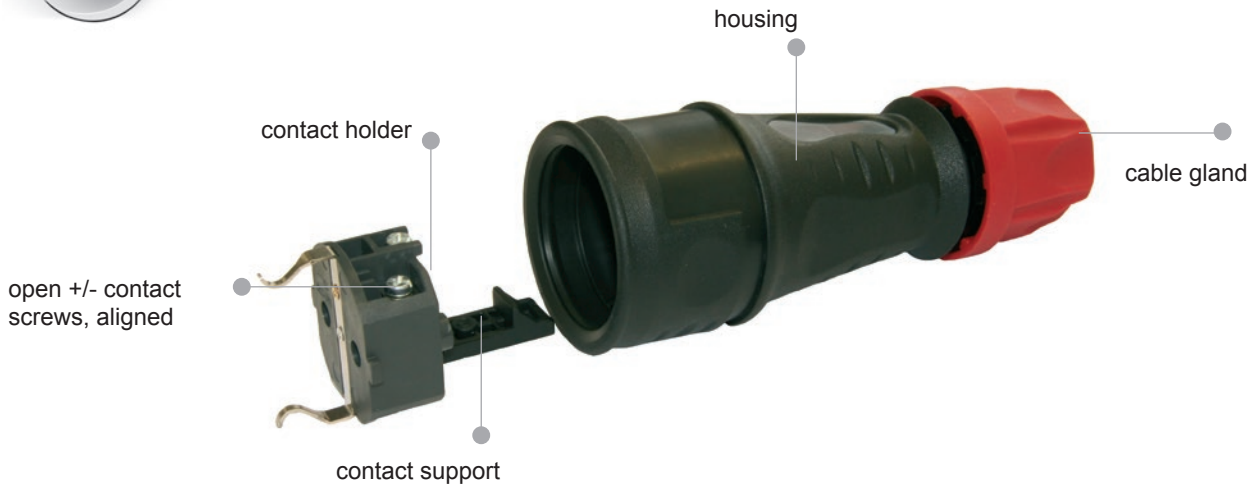

## 3-WAY CONNECTOR

- hinged lid (self closing)
- large connection area
- 3 or 5 pole terminal
- suspension hook



## CABLE CLAMP

- externally placed
- easy handling
- simple assembly
- for cable diameters from Ø 6mm to Ø 13mm

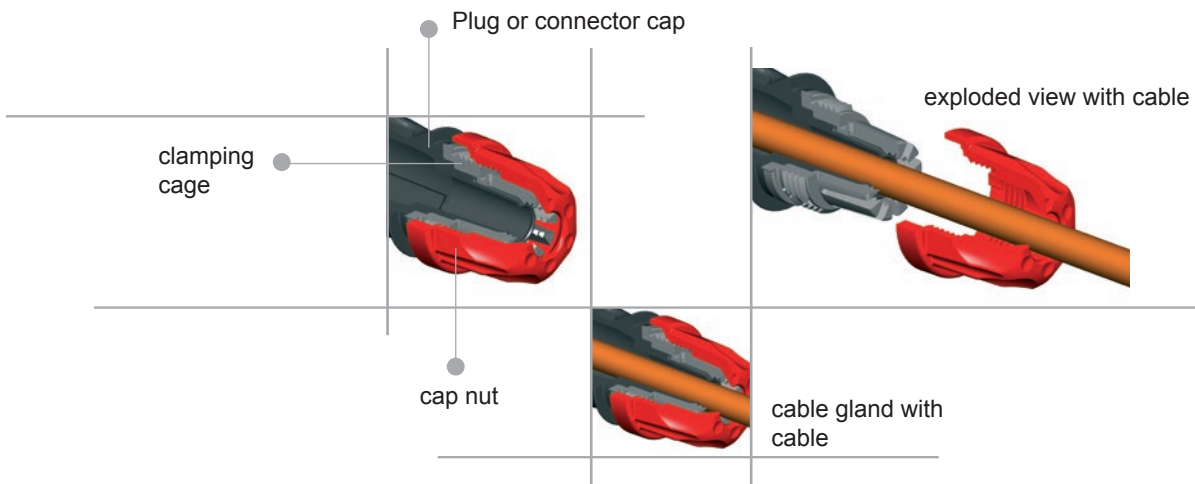



### Solid rubber plug IP44

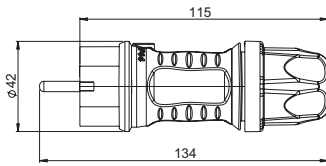

• Insert: rubber

IP44 splashproof



Insert:		dual earthing system	
Rubber		05622-s	
pack.unit		20	

### Solid rubber connector with cap IP44

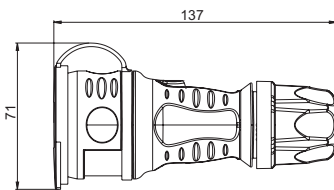

• with cap

IP44 splashproof

Insert:	acc. Austrian/German system	acc. Belg./French System
Rubber	25621-s	
Polyamide with sealing bulge		24611-s
Polyamide with sealing bulge and child protection		24611-sc
pack.unit	10	10

### Solid rubber connector with hinged lid IP44

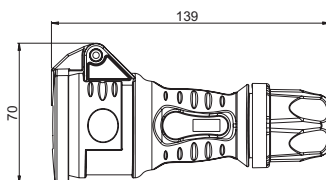

• with hinged lid

IP44 splashproof

Insert:	acc. Austrian/German system	
Rubber	25622-s	
pack.unit	10	

## CONNECTOR SYSTEMS

### 3-way connector solid rubber with hinged lid IP44

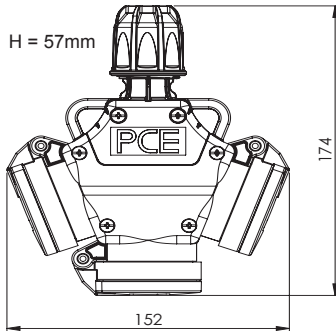

- With hinged lid
- External centric cable gland
- Insert: rubber

IP44 splashproof



Insert:	acc. Austrian/German system	
Rubber	253622-s	
pack.unit	5	

### 3-way connector solid rubber with hinged lid and 5-pole terminal IP44



- 5-pole terminal
- With hinged lid
- External centric cable gland
- Insert: rubber

IP44 splashproof



Insert:	acc. Austrian/German system	
Rubber	253622-s5	
pack.unit	5	

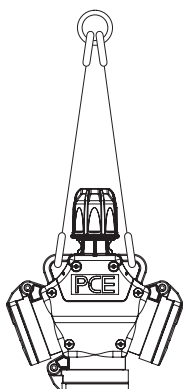

3-way connectors are also perfectly for hanging usage!

