



ITT

Electronic Components

Cannon MIL-DTL-38999 Connectors



Engineered for life

Delivering solutions that perform ...

ITT offers an extensive array of connector and switch products and the ability to deliver standard or custom solutions to meet the most stringent military requirements.

Our interconnect range includes sealed circulars, plastic and metal shell bayonet coupling circulars, miniature metal shell circulars, PC board header connectors and sensor and direct device connectors. ITT is also a systems supplier, providing value-added module and harness assemblies.

In addition to our MIL-DTL-38999 series, we also offer these connectivity solutions:



Cannon KPT / KPSE

Environmentally sealed miniature circular connectors available in two versions: KPT (solder contact) and KPSE (high performance crimp contact). Intermateable and intermountable with all MIL-C-26482 connectors and is available with many materials, finishes and configurations.



Cannon Combo D-Sub

Product offering includes ability to integrate signal and coax, high power, and high voltage.

Table of Contents

Specifications and Test Data	3-5
KJL	6-9
KJ	10-15
KJA	16-18
Polarizing Positions	19
Contact Arrangements	20-21
Contacts	22-24
Torque Values	25
Backshells	26-27
Tools	28
Assembly Instructions	29
MIL-DTL-38999 Specifications	30



Cannon CA-Bayonet

Signal and power connectors with exceptional sealing against the ingress of fluids and will withstand the effects of high vibrations.



Cannon Microminiature

High performance and reliability with exceptional versatility. Available in rectangular, circular and strip configurations, many of our connectors meet or exceed the applicable requirements of the MIL-DTL-83513 specification.

ITT logo blocks and the composite ITT logo are registered trademarks of ITT Industries. ©2005



MIL-DTL-38999 Series I, II, III Connectors

Cannon KJL/KJ/KJA

SERIES I

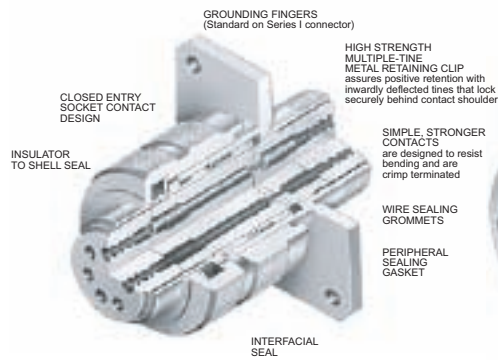

SERIES II

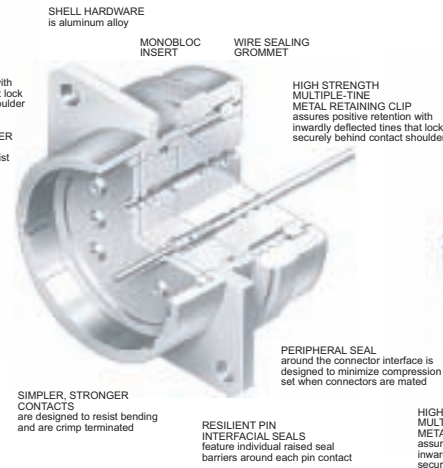

SERIES III

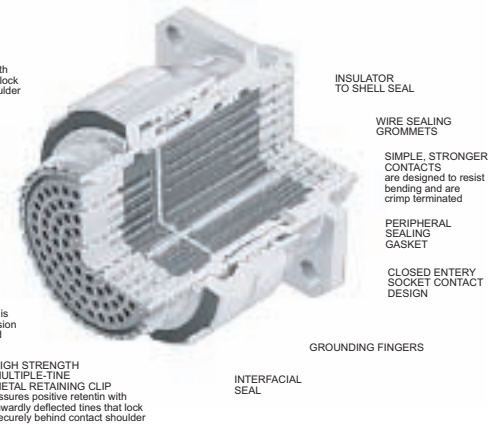

- Corrosion-resistant shells of aluminum alloy with cadmium over nickel plating withstand a 500 hour salt spray exposure
- Rear release crimp snap-in contacts
- High contact density
- Standard MIL-C-39029 contacts, MIL-I-81969 application tools and MIL-STD 1560 insert arrangements

- Special/custom capabilities
- 100% scoop-proof - Series I and III
- Light weight /Low Profile - Series II
- Operates under severe high temperature vibration testing through 200 C - engineered for high density circuitry - Series III

- Interfacial seal helps prevent electrolytic erosion of contacts - Series III
- Superior EMI shielding provides outstanding protection up to 65dB at 10 GHZ. - Series III

Specification Comparison

Design Criteria	Series I	Series II	Series III
Low Profile/Light Weight	no	yes	no
Scoop Proof	yes	no	yes
Coupling System	Bayonet	Bayonet	Triple Lead Thread
Electrolytic Erosion	no	no	yes
Durability (Cycles)	500	250	500
High Impact Shock	yes	no	yes
External Bending Moment			
Shell Size 25	650 in/lbs	150 in/lbs	1000 in/lbs
Random Vibration "J"	Ambient	Ambient	492 F
Sine Vibration	30G, Ambient		60G, -85 to +392 F
Sand, Dust, Ice	yes		yes
Shell Size	9-25	8-24	9-25

Contact Rating

Contact Size	Test Current DC Test Amperage	Maximum Millivolt Drop*	Crimp Well Data	
			Well Diameter	Well Depth
22D	5	40	.0345 ± .0010	.157/.141
22M**	3	30	.0280 ± .0010	.157/.141
22**	5	40	.0365 ± .0010	.157/.141
20	7.5	35	.0470 ± .0010	.229/.209
16	13	25	.0670 ± .0010	.229/.209
12	23	25	.1000 ± .0020	.229/.209

* Maximum millivolt drop data is determined by measuring resistance of mated contacts from end to end

** For reference only

Performance and Material Specifications

MATERIALS AND FINISHES

	Receptacle	Grounded Plug
Shell	Aluminum alloy	Aluminum alloy*
Insulator	High grade plastic	High grade plastic
Contacts	Copper alloy, gold plate	Copper alloy, gold plate
Grommet and Seal	Silicone base elastomer	Silicone base elastomer
Jam Nut	Aluminum alloy	-
Grounding Spring	-	Beryllium copper

*Finish as noted in How To Order sections.

ELECTRICAL DATA

Contact Size: 22D, 22M*, 22*, 20, 16 and 12

Contact Rating and Wire Size Accomodation

Wire Size	Contact Size and Test Amps					
	22D	22M*	22*	20	16	12
28	1.5	1.5	-	-	-	-
26	2.0	2.0	2.0	-	-	-
24	3.0	3.0	3.0	3.0	-	-
22	5.0	-	5.0	5.0	-	-
20	-	-	-	7.5	7.5	-
18	-	-	-	-	10.0	-
16	-	-	-	-	13.0	-
14	-	-	-	-	-	17.0
12	-	-	-	-	-	23.0

*For reference only

Service Rating

Altitude	Service Rating M		Service Rating N		Service Rating I		Service Rating II	
	Mated	Unmated	Mated	Unmated	Mated	Unmated	Mated	Unmated
Sea Level	1300	1300	1000	1000	1800	1800	2300	2300
50,000 ft.	800	550	600	400	1000	600	1000	800
70,000 ft.	800	350	600	260	1000	400	1000	500
100,000 ft.	800	200	600	200	1000	200	1000	200

Test voltage, AC (rms)

Test Data

Test Description	Parameters
Durability	500 cycles of mating and unmating, 250 cycles for Series II with spring fingers
Temperature Range	Class F, N; - 65°C (-85°F) to + 200°C (+392°F) Class A; - 65°C (-85°F) to + 150°C (+302°F) Class B,W: - 65°C (-85°F) to + 175°C (+347°F)
Vibration	Mated connectors are vibrated with weights to simulate rear accessory loads to the following levels: Sine Vibration: Up to 60 G's - Series I & III (at rated temperature - Series III) Not applicable for Series II. Random Vibration: 43.7 Grms at rated temperature - Series III 49.5 Grms at Ambient Temperature - Series I & III 43.7 Grms at Ambient Temperature - Series II
EMI Shielding Effectiveness	Class F: EMI leakage attenuation, greater than 90dB at 100Mhz, greater than 65dB at 10 GHz. Shell to shell conductivity, 1.0 millivolt max. resistance. Class W: EMI leakage attenuation, greater than 90dB at 100 MHz, greater than 50dB at 10 GHz. Shell to shell conductivity, 2.5 millivolt max.
Corrosion Resistant	Class B, W, will withstand 500 hours salt spray. Class A, F, N, will withstand 48 hours salt spray.
Fluid Immersion	Connectors are fluid resistant to many fuels, solvents, coolants and oils.
High Impact Shock	Mated connectors terminated with MIL-C-915 cable and environmentally sealed backshells will withstand high impact shock per MIL-S-901. Applicable to Series I & III only.
Altitude	Designed to operate between sea level and 100,000 ft. above sea level.
Other Environments	Mated connectors shall withstand sand and dust per method 110 of MIL-STD-202 and be ice resistant. Applicable to Series I & III only.

NOTE: For hermetic standard or test data please consult ITT.



Insert Availability and Identification

Series II	Series I & III	Service Rating	Total Contacts	Contact Size				
				22D	20	16	12	8
8-35	9-35	M	6	6				
8-98	9-98	I	3		3			
	11-4	I	4		4			
10-5	11-5	I	5		5			
10-35	11-35	M	13	13				
10-98	11-98	I	6		6			
10-99	11-99	I	7		7			
12-3		II	3			3		
12-4	13-4	I	4			4		
12-8	13-8	I	8		8			
12-35	13-35	M	22	22				
12-98	13-98	I	10		10			
14-5	15-5	II	5			5		
14-15	15-15	I	15		14	1		
14-18	15-18	I	18		18			
	15-19	I	19		19			
14-35	15-35	M	37	37				
14-97	15-97	I	12		8	4		
16-6	17-6	I	6				6	
16-8	17-8	II	8			8		
16-26	17-26	I	26		26			
16-35	17-35	M	55	55				
16-99	17-99	I	23		21	2		
18-11	19-11	II	11			11		
18-28	19-28	I	28		26	2		
18-30	19-30	I	30		29	1		
18-32	19-32	I	32		32			
18-35	19-35	M	66	66				
	21-11	I	11				11	
20-16	21-16	II	16			16		
20-35	21-35	M	79	79				
20-39	21-39	I	39		37	2		
20-41	21-41	I	41		41			
	21-75	M	4					4***
22-21	23-21	II	21			21		
22-32	23-32	I	32		32			
22-35	23-35	M	100	100				
22-53	23-53	I	53		53			
22-55	23-55	I	55		55			
24-4	25-4	I	56		48	8		
	25-19	I	19				19	
24-24	25-24	I	24			12	12	
24-29	25-29	I	29			29		
24-35	25-35	M	128	128				
	25-37	I	37			37		
	25-43	I	43		23	20		
	25-46	I, Twinax	46		40	4		2***
	25-8	Twinax	8					8***
	25-20	N, Coax, Twinax	30		10	13	4**	3***
	25-42	I, Coax	42		38			4*
24-61	25-61	I	61		61			
	25-64	I	64	40	8	10	6	
	25-66	I	66	53	2	11		

* Coax for RG-180 cables
 ** Coax for RG-174, -179, or -316 cables
 *** Twinax for M17/176-00002 cables
 (check factory for other cable applications)

How To Order

Military Nomenclature

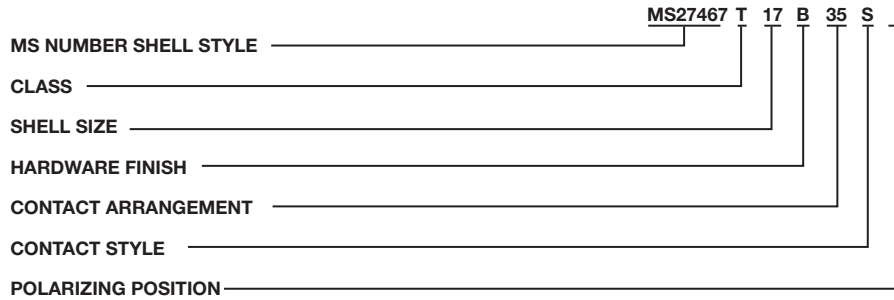

MS NUMBER SHELL STYLE

- MS27466 - Wall Mounting Receptacle
- MS27468 - Jam Nut Receptacle
- MS27467 - Grounded Plug
- MS27656 - Wall Mounting Receptacle (back panel mounting)
- MS27505 - Box Mounting Receptacle (back panel) (Class E)

CLASS

- E - Inactive for new design. Superseded by Class T.
- P - Environment - resistant with straight potting cup accessories
- T - Environment - resistant with accessory threads and teeth, except MS27505 (without rear accessory) (Class T not applicable to MS27505)

SHELL SIZE

9, 11, 13, 15, 17, 19, 21, 23, and 25

HARDWARE FINISH STANDARD

- A - Bright cadmium over electroless nickel plate, -85°F to +302°F (-65°C to +150°C)
- B - Olive drab cadmium over electroless nickel plate, -85°F to +347°F (-65°C to +175°C)
- F - Electroless nickel, -85°F to +392°F (-65°C to +200°C)

CONTACT ARRANGEMENT

See pages 20 and 21.

CONTACT STYLE

- P - Pin
- S - Socket
- *A - Less Pin Contact
- *B - Less Socket Contact

*Used only when other than power contacts are to be installed (i.e. shielded, thermocouple, etc.)

POLARIZING POSITION

A, B, C, and D. (No letters required for normal). See page 19.

Note: To order MS connectors less standard power contacts, purchase order must state "Less Contacts"

Cannon Nomenclature

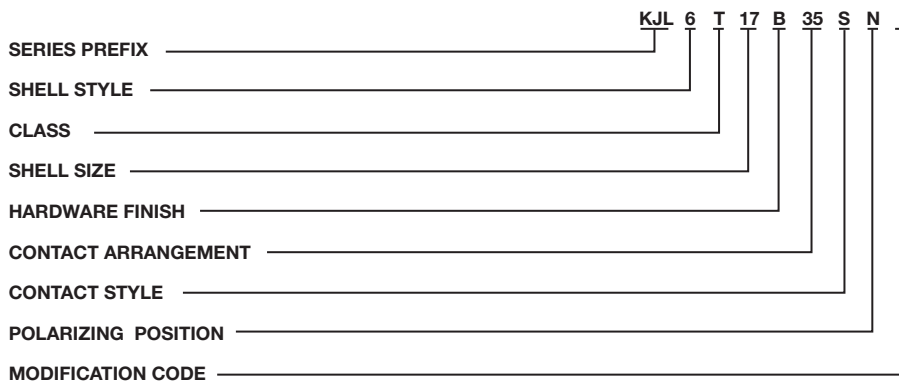

SERIES PREFIX

KJL - Series I-Scoop proof

SHELL STYLE

- 0 - Wall mounting receptacle
- 3 - Wall mounting receptacle (back panel mounting)
- 5 - Box mounting receptacle (back panel mounting)
- 6 - Straight plug, grounded
- 7 - Jam nut receptacle

CLASS

- E - Inactive for new design. Superseded by Class T.
- F - Environment - resistant with strain relief accessory
- P - Environment - resistant with straight potting cup accessory
- T - Environment - resistant (without rear accessory) (Class T not applicable to KJL5)

SHELL SIZE

9, 11, 13, 15, 17, 19, 21, 23 and 25

HARDWARE FINISH STANDARD

- A - Bright cadmium over electroless nickel plate, -85°F to +302°F (-65°C to +150°C)
- B - Olive drab cadmium over electroless nickel plate, -85°F to +347°F (-65°C to +175°C)
- N - Electroless nickel, -85°F to +392°F (-65°C to +200°C)

CONTACT ARRANGEMENT

See pages 20 and 21.

CONTACT STYLE

- P - Pin
- S - Socket

POLARIZING POSITION

N (normal), A, B, C, D. See page 19.

MODIFICATION CODE

- L - Less contacts, not stamped on connector
- 16 - Outgassed NASA space graded connector
- 27 - Outgassed, standard connector



Wall Mounting Receptacle

MS27466
(MS service class E, P, T)

KJL0

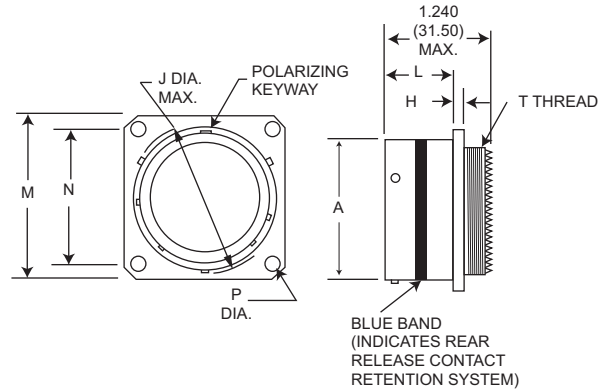

NOTE: For backshell dimensions and configurations, see pages 26 and 27.

Shell Size	A Dia. Max.	H Max.	J Dia. Max.	L Max.	M Max.	N T.P.	P Dia. Max.	T Thread	Overall Length With Backshells	
									F Cable Clamp	P Potting Max.
9	.573 (14.55)	.100 (2.54)	.662 (16.81)	.632 (16.05)	.958 (24.33)	.719 (18.26)	.138 (3.51)	7/16-28UNEF-2A	1.846 (46.89)	1.451 (36.86)
11	.701 (17.81)	.100 (2.54)	.810 (20.57)	.632 (16.05)	1.051 (26.70)	.812 (20.62)	.138 (3.51)	9/16-24UNEF-2A	1.846 (46.89)	1.451 (36.86)
13	.851 (21.62)	.100 (2.54)	.960 (24.38)	.632 (16.05)	1.145 (29.08)	.906 (23.01)	.138 (3.51)	11/16-24UNEF-2A	1.846 (46.89)	1.451 (36.86)
15	.976 (24.79)	.100 (2.54)	1.085 (27.56)	.632 (16.05)	1.239 (31.47)	.969 (24.61)	.138 (3.51)	13/16-20UNEF-2A	1.846 (46.89)	1.451 (36.86)
17	1.101 (27.97)	.100 (2.54)	1.210 (30.73)	.632 (16.05)	1.332 (33.83)	1.062 (26.97)	.138 (3.51)	15/16-20UNEF-2A	1.966 (49.94)	1.451 (36.86)
19	1.208 (30.68)	.100 (2.54)	1.317 (33.45)	.632 (16.05)	1.458 (37.03)	1.156 (29.36)	.138 (3.51)	1-1/16-18UNEF-2A	1.966 (50.70)	1.451 (36.86)
21	1.333 (33.86)	.130 (3.30)	1.442 (36.63)	.602 (15.29)	1.582 (40.18)	1.250 (31.75)	.138 (3.51)	1-3/16-18UNEF-2A	1.966 (50.70)	1.451 (36.86)
23	1.458 (37.03)	.130 (3.30)	1.567 (39.80)	.602 (15.29)	1.708 (43.38)	1.375 (34.93)	.157 (3.99)	1-5/16-18UNEF-2A	1.966 (50.70)	1.451 (36.86)
25	1.583 (40.21)	.130 (3.30)	1.692 (42.98)	.602 (15.29)	1.832 (46.53)	1.500 (38.10)	.157 (3.99)	1-7/16-18UNEF-2A	1.966 (50.70)	1.451 (36.86)

Wall Mounting Receptacle (Back Panel)

MS27656
(MS service class E, P, T)

KJL3

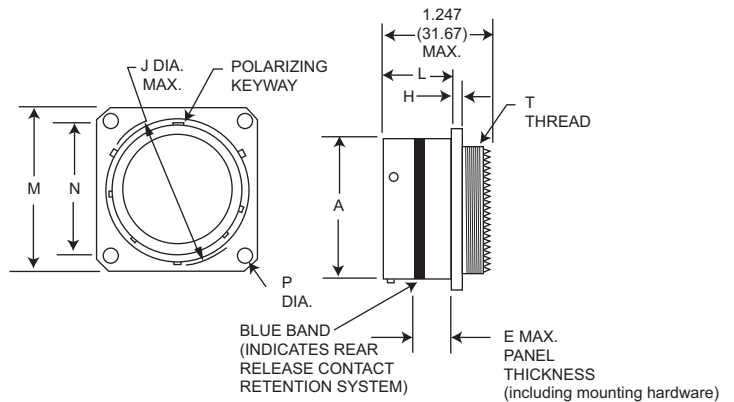

NOTE: For backshell dimensions and configurations, see pages 26 and 27.

Shell Size	A Dia. Max.	E Max.	H Max.	J Dia. Max.	L Max.	M Max.	N T.P.	P Dia. Max.	T Thread	Overall Length With Backshells	
										F Cable Clamp	P Potting Max.
9	.573 (14.55)	.234 (5.94)	.100 (2.54)	.662 (16.81)	.820 (20.83)	.958 (24.33)	.719 (18.26)	.138 (3.51)	7/16-28UNEF-2A	1.805 (45.85)	1.410 (35.81)
11	.701 (17.81)	.234 (5.94)	.100 (2.54)	.810 (20.57)	.820 (20.83)	1.051 (26.70)	.812 (20.62)	.138 (3.51)	9/16-24UNEF-2A	1.805 (45.85)	1.410 (35.81)
13	.851 (21.62)	.234 (5.94)	.100 (2.54)	.960 (24.38)	.820 (20.83)	1.145 (29.08)	.906 (23.01)	.138 (3.51)	11/16-24UNEF-2A	1.805 (45.85)	1.410 (35.81)
15	.976 (24.79)	.234 (5.94)	.100 (2.54)	1.085 (27.56)	.820 (20.83)	1.239 (31.47)	.969 (24.61)	.138 (3.51)	13/16-20UNEF-2A	1.805 (45.85)	1.410 (35.81)
17	1.101 (27.97)	.234 (5.94)	.100 (2.54)	1.210 (30.73)	.820 (20.83)	1.332 (33.83)	1.062 (26.97)	.138 (3.51)	15/16-20UNEF-2A	1.935 (48.90)	1.410 (35.81)
19	1.208 (30.68)	.234 (5.94)	.100 (2.54)	1.317 (33.45)	.820 (20.83)	1.458 (37.03)	1.156 (29.36)	.138 (3.51)	1-1/16-18UNEF-2A	1.955 (49.66)	1.410 (35.81)
21	1.333 (33.86)	.204 (5.18)	.130 (3.30)	1.442 (36.63)	.790 (20.07)	1.582 (40.18)	1.250 (31.75)	.138 (3.51)	1-3/16-18UNEF-2A	1.955 (49.66)	1.410 (35.81)
23	1.458 (37.03)	.204 (5.18)	.130 (3.30)	1.567 (39.80)	.790 (20.07)	1.708 (43.38)	1.375 (34.93)	.157 (3.99)	1-5/16-18UNEF-2A	1.955 (49.66)	1.410 (35.81)
25	1.583 (40.21)	.193 (4.90)	.130 (3.30)	1.692 (42.98)	.790 (20.07)	1.832 (46.53)	1.500 (38.10)	.157 (3.99)	1-7/16-18UNEF-2A	1.955 (49.66)	1.410 (35.81)

Performance Specifications-Pages 3-4 Contacts, Sealing Plugs, Assembly Tools - Pages 22, 27, 28. Contact Arrangements - Pages 20-21

Dimensions shown in mm
Specifications and dimensions subject to change

www.ittcannon.com



Box Mounting Receptacle (Back Panel)

MS27505E
(MS service class E)

KJL5E

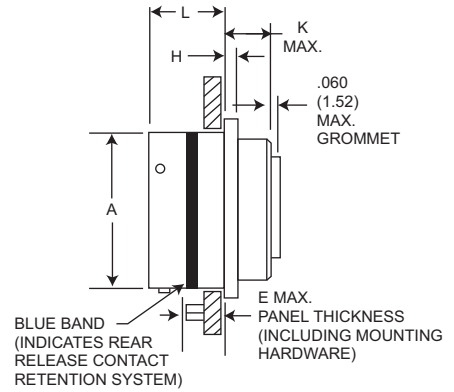
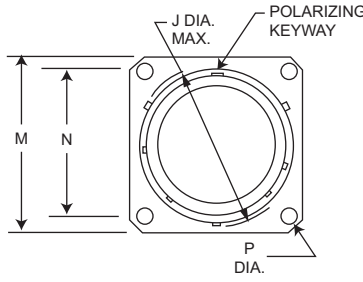

NOTE: This connector does not accommodate backshells.

Shell Size	A Dia. Max.	E Max.	H Max.	J Dia. Max.	K Max.	L Max.	M Max.	N T.P.	P Dia. Max.
9	.573 (14.55)	.234 (5.94)	.100 (2.54)	.662 (16.81)	.219 (5.56)	.820 (20.83)	.958 (24.33)	.719 (18.26)	.138 (3.51)
11	.701 (17.81)	.234 (5.94)	.100 (2.54)	.810 (20.57)	.219 (5.56)	.820 (20.83)	1.051 (26.70)	.812 (20.62)	.138 (3.51)
13	.851 (21.62)	.234 (5.94)	.100 (2.54)	.960 (24.38)	.219 (5.56)	.820 (20.83)	1.145 (29.08)	.906 (23.01)	.138 (3.51)
15	.976 (24.79)	.234 (5.94)	.100 (2.54)	1.085 (27.56)	.219 (5.56)	.820 (20.83)	1.239 (31.47)	.969 (24.61)	.138 (3.51)
17	1.101 (27.97)	.234 (5.94)	.100 (2.54)	1.210 (30.73)	.219 (5.56)	.820 (20.83)	1.332 (33.83)	1.062 (26.97)	.138 (3.51)
19	1.208 (30.68)	.234 (5.94)	.100 (2.54)	1.317 (33.45)	.219 (5.56)	.820 (20.83)	1.458 (37.03)	1.156 (29.36)	.138 (3.51)
21	1.333 (33.86)	.204 (5.18)	.130 (3.30)	1.442 (36.63)	.250 (6.35)	.790 (20.07)	1.582 (40.18)	1.250 (31.75)	.138 (3.51)
23	1.458 (37.03)	.204 (5.18)	.130 (3.30)	1.567 (39.80)	.250 (6.35)	.790 (20.07)	1.708 (43.38)	1.375 (34.93)	.157 (3.99)
25	1.583 (40.21)	.193 (4.90)	.130 (3.30)	1.692 (42.98)	.250 (6.35)	.790 (20.07)	1.832 (46.53)	1.500 (38.10)	.157 (3.99)

Straight Plug Grounded

MS27467
(MS service class E, P, T)

KJL6

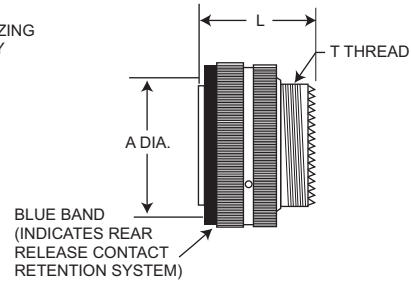
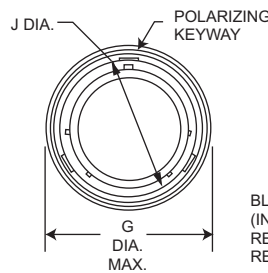

NOTE: For backshell dimensions and configurations, see pages 26 and 27.

Shell Size	A Max.	G Dia. Max.	J Dia. Max.	(Class T) L Max.	T Thread	Overall Length With Backshells	
						F Cable Clamp	P Potting Max.
9	.585 (14.86)	.859 (21.82)	.483 (12.27)	1.234 (31.34)	7/16-28UNEF-2A	1.793 (45.54)	1.671 (42.44)
11	.717 (18.21)	.984 (24.99)	.611 (15.52)	1.234 (31.34)	9/16-24UNEF-2A	1.793 (45.54)	1.671 (42.44)
13	.866 (22.00)	1.156 (29.36)	.760 (19.30)	1.234 (31.34)	11/16-24UNEF-2A	1.793 (45.54)	1.671 (42.44)
15	.990 (25.15)	1.281 (32.54)	.885 (22.48)	1.234 (31.34)	13/16-20UNEF-2A	1.793 (45.54)	1.671 (42.44)
17	1.115 (28.32)	1.406 (35.71)	1.010 (25.65)	1.234 (31.34)	15/16-20UNEF-2A	1.913 (48.59)	1.671 (42.44)
19	1.222 (31.04)	1.516 (38.51)	1.115 (28.32)	1.234 (31.34)	1-1/16-18UNEF-2A	1.943 (49.35)	1.671 (42.44)
21	1.347 (34.21)	1.641 (41.68)	1.240 (31.50)	1.234 (31.34)	1-3/16-18UNEF-2A	1.943 (49.35)	1.766 (44.86)
23	1.472 (37.39)	1.766 (44.86)	1.365 (34.67)	1.234 (31.34)	1-5/16-18UNEF-2A	1.943 (49.35)	1.766 (44.86)
25	1.597 (40.56)	1.891 (48.03)	1.490 (37.85)	1.234 (31.34)	1-7/16-18UNEF-2A	1.943 (49.35)	1.766 (44.86)

Performance Specifications-Pages 3-4

Contacts, Sealing Plugs, Assembly Tools - Pages 22, 27-28.

Contact Arrangements - Pages 20-21



Dimensions shown in mm
Specifications and dimensions subject to change

www.ittcannon.com

Jam Nut Receptacle

MS27468
(MS service class E,P,T)

KJL7

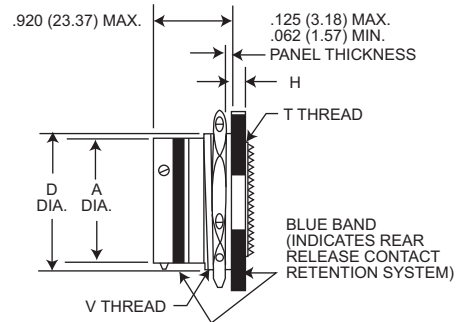
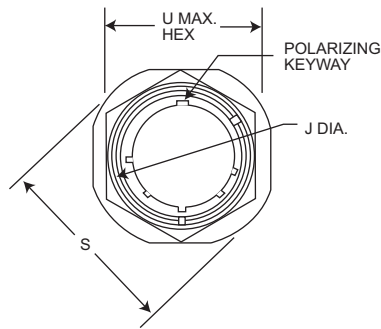

NOTE: For backshell dimensions and configurations, see pages 26 and 27.

Shell Size	A Dia. Max.	D Max.	H Max.	J Dia. Max.	S Dia. Max.	T Thread	U Max. Hex.	V Thread Class 2A	Overall Length With Backshells	
									F Cable Clamp	P Potting Max.
9	.573 (14.55)	.655 (16.64)	.120 (3.05)	.662 (16.81)	1.204 (30.58)	7/16-28UNEF-2A	.892 (22.66)	11/16-24UNEF	1.846 (46.89)	1.451 (36.86)
11	.701 (17.81)	.755 (19.18)	.120 (3.05)	.810 (20.57)	1.391 (35.33)	9/16-24UNEF-2A	1.017 (25.83)	13/16-24UNEF	1.846 (46.89)	1.451 (36.86)
13	.851 (21.62)	.942 (23.93)	.120 (3.05)	.960 (24.38)	1.516 (35.51)	11/16-24UNEF-2A	1.205 (30.61)	1-20UNEF	1.846 (46.89)	1.451 (36.86)
15	.976 (24.79)	1.066 (27.08)	.120 (3.05)	1.085 (27.56)	1.641 (41.68)	13/16-20UNEF-2A	1.329 (33.76)	1-1/8-18UNEF	1.846 (46.89)	1.451 (36.86)
17	1.101 (27.97)	1.191 (30.25)	.120 (3.05)	1.210 (30.73)	1.766 (44.86)	15/16-20UNEF-2A	1.455 (36.96)	1-1/4-18UNEF	1.966 (49.94)	1.451 (36.86)
19	1.208 (30.68)	1.316 (33.43)	.151 (3.84)	1.317 (33.45)	1.954 (49.63)	1-1/16-18UNEF-2A	1.579 (40.11)	1-3/8-18UNEF	1.996 (50.70)	1.451 (36.86)
21	1.333 (33.86)	1.441 (36.60)	.151 (3.84)	1.442 (36.63)	2.078 (52.78)	1-3/16-18UNEF-2A	1.705 (43.31)	1-1/2-18UNEF	1.996 (50.70)	1.451 (36.86)
23	1.458 (37.03)	1.566 (39.78)	.151 (3.84)	1.567 (39.80)	2.204 (55.98)	1-5/16-18UNEF-2A	1.829 (46.46)	1-5/8-18UNEF	1.996 (50.70)	1.451 (36.86)
25	1.583 (40.21)	1.691 (42.95)	.151 (3.84)	1.692 (42.98)	2.328 (59.13)	1-7/16-18UNEF-2A	20.17 (51.23)	1-3/4-18UNS	1.996 (50.70)	1.451 (36.86)

Performance Specifications-Pages 3-4

Contacts, Sealing Plugs, Assembly Tools - Pages 22, 27-28.

Contact Arrangements - Pages 20-21

Panel Cutouts

Flange Mounted Receptacles

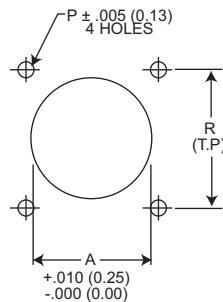

Jam Nut Receptacles

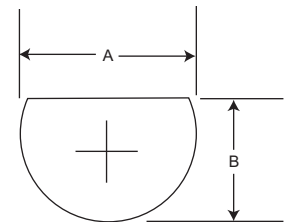

Shell Size	A Dia.	P Dia.	(Class T)		Mtg. Screw	Shell Size	A +.010 (.25) -.000 (.00)	B +.000 (.00) -.010 (.25)
			R					
9	.665 (16.89)	.128 (3.25)	.719 (18.26)		#4	9	.700 (17.78)	.670 (17.02)
11	.812 (20.62)	.128 (3.25)	.812 (20.62)		#4	11	.825 (20.96)	.771 (19.58)
13	.965 (24.51)	.128 (3.25)	.906 (23.01)		#4	13	1.010 (25.65)	.955 (24.26)
15	1.085 (27.55)	.128 (3.25)	.969 (24.61)		#4	15	1.135 (28.83)	1.085 (27.56)
17	1.250 (31.75)	.128 (3.25)	1.062 (26.97)		#4	17	1.260 (32.00)	1.210 (30.73)
19	1.322 (33.57)	.128 (3.25)	1.156 (29.36)		#4	19	1.385 (35.18)	1.335 (33.91)
21	1.447 (36.75)	.128 (3.25)	1.250 (31.75)		#4	21	1.510 (38.35)	1.460 (37.08)
23	1.569 (39.85)	.154 (3.91)	1.375 (34.93)		#6	23	1.635 (41.53)	1.585 (40.26)
25	1.703 (43.25)	.150 (3.81)	1.500 (38.10)		#6	25	1.760 (44.70)	1.710 (43.43)

Dimensions shown in mm

Specifications and dimensions subject to change

www.ittcannon.com



Polarizing Positions

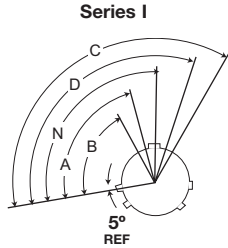

Front face of receptacle (plug opposite). Insert arrangement does not rotate with main key-keyway. The master key is rotated to provide shell polarization; the minor keys remain fixed.

Shell Size	Angle of Rotation (Degrees)				
	Normal	A	B	C	D
9	95°	77°			113°
11	95°	81°	67°		109°
13	95°	75°	63°	123°	115°
15	95°	74°	61°	129°	116°
17	95°	77°	65°	125°	113°
19	95°	77°	65°	125°	113°
21	95°	77°	65°	125°	113°
23	95°	80°	69°	121°	110°
25	95°	80°	69°	121°	110°

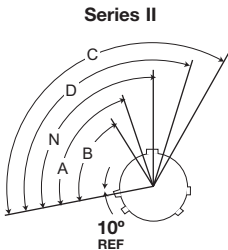

Front face of receptacle (plug opposite). Insert arrangement does not rotate with main key-keyway. The master key is rotated to provide shell polarization; the minor keys remain fixed.

Shell Size	Angle of Rotation (Degrees)				
	Normal	A	B	C	D
8	100°	82°			118°
10	100°	86°	72°	128°	114°
12	100°	80°	68°	132°	120°
14	100°	79°	66°	134°	121°
16	100°	82°	70°	130°	118°
18	100°	82°	70°	130°	118°
20	100°	82°	70°	130°	118°
22	100°	85°	74°	126°	115°
24	100°	85°	74°	126°	115°

Series III

RECEPTACLE
(Front face shown)

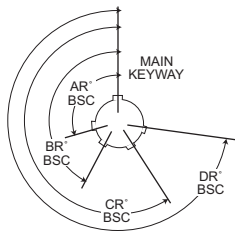

PLUG
(Front face shown)

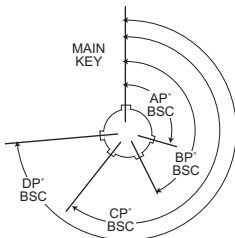

NOTES

- All Angles are BSC
- The insert arrangement does not rotate with main key/keyway
- All minor keys are rotated to provide shell polarization, the master key remains fixed at twelve o'clock position.
- Polarization is different from Series I and II.

Shell Size	Key & Keyway Arrangement identification Letter	Key Locations			
		AR° or AP° BSC	BR° or BP° BSC	CR° or CP° BSC	DR° or DP° BSC
9	N	105	140	215	265
	A	102	132	248	320
	B	80	118	230	312
	C	35	140	205	275
	D	64	155	234	304
E	91	131	197	240	
11	N	95	141	208	236
13	A	113	156	182	292
15	B	90	145	195	252
and	C	53	156	220	255
15	D	119	146	176	298
E	51	141	184	242	
17	N	80	142	196	293
and	A	135	170	200	310
19	B	49	169	200	244
and	C	66	140	200	257
19	D	62	145	180	280
E	79	153	197	272	
21	N	80	142	196	293
23	A	135	170	200	310
25	B	49	169	200	244
and	C	66	140	200	257
25	D	62	145	180	280
E	79	153	197	272	

Contact Arrangements (Engaging View Pin Insert)

* Socket insert only

** Pin insert only (Not available in socket insert Series I and III)

Indicates layouts are available in all shell styles including MS27499, MS27508, KJ2E and KJ5E

• Consult factory MS27505E/KJL5E insert availability

Series III	9-98	9-35	-	11-5	11-98	-	11-35	13-8
Series II	8-98†	8-35†	-	10-5†	10-98†	10-99†	10-35†	12-8†
Series I	9-98	9-35	11-4	11-5	11-98	11-99	11-35	13-4**
No. of Contacts	3 #20	6 #22D	4 #20	5 #20	6 #20	7 #20	13 #22D	8 #20
Service Ratings	I	M	I	I	I	I	II	I

Series III	13-98	13-35	15-5	15-15	15-18	15-19	15-35
Series II	12-98†	12-35†	14-5†	14-15†	14-18†	-	14-35†
Series I	13-98	13-35	15-5	15-15	15-18	15-19	15-35
No. of Contacts	10 #20	22 #22D	5 #16	14 #20, 1 #16	18 #20	19 #20	37 #22D
Service Ratings	I	M	II	I	I	I	M

Series III	15-97	17-6	17-8	17-26	17-35	-	16-99†
Series II	14-97†	16-6	16-8†	16-26†	16-35†	16-42†	17-99**
Series I	15-97	17-6	17-8	17-26	17-35	42 #22	17-99**
No. of Contacts	8 #20, 4 #16	6 #12	8 #16	26 #20	55 #22D	M	21 #20, 2 #16
Service Ratings	I	I	II	I	M	M	I

Series III	-	-	19-11	19-32	19-35
Series II	18-28	18-30	18-11	18-32†	18-35†
Series I	19-28**	19-30**	19-11	19-32	19-35
No. of Contacts	26 #20, 2 #16	29 #20, 1 #16	11 #16	32 #20	66 #22D
Service Ratings	I	I	II	I	M

Series III	21-11	21-16	21-35	21-39	21-41
Series II	-	20-16†	20-35†	20-39†	20-41†
Series I	21-11	21-16	21-35	21-39	21-41
No. of Contacts	11 #12	16 #16	79 #22D	37 #20, 2 #16	41- #20
Service Ratings	I	II	M	I	I

Series III	21-75	23-21	-	23-35
Series II	-	22-21	22-32	22-35†
Series I	21-75*	23-21	23-32**	23-35
No. of Contacts	4 #8 Twinax	21 #16	32 #20	100 #22D
Service Ratings	M	II	I	M

Please consult factory for availability of layouts not shown.



Contact Arrangements (Engaging View Pin Insert)

* Socket insert only

** Pin insert only (Not available in socket insert Series I and III)

† Indicates layouts are available in all shell styles including MS27499, MS27508, KJ2E and KJ5E

• Consult factory for MS27505E/KJL5E insert availability for "inactive" layout, use-35.

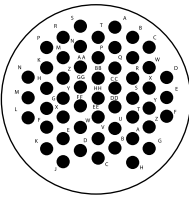
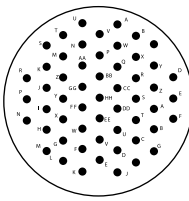
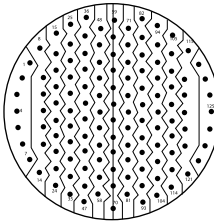
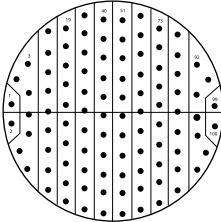
		Inactive	Inactive	
				
Series III	23-53	23-55	-	25-4
Series II	22-53†	22-55†	24-1†	24-4†
Series I	23-53	23-55	25-1**	25-4
No. of Contacts	53 #20	55 #20	128 #22M	48 #20, 8 #16
Service Ratings	I	I	M	I

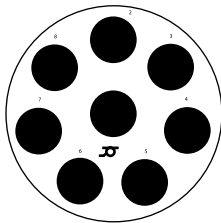
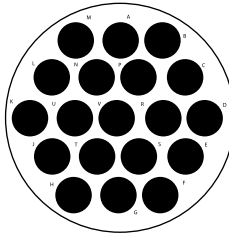
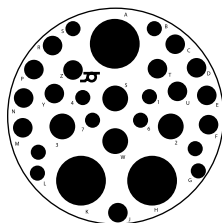
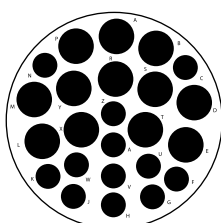
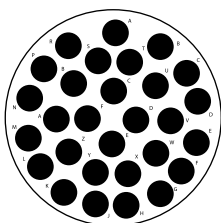
					
Series III	25-8	25-19	25-20	25-24	25-29
Series II	-	-	-	24-24†	24-29†
Series I	25-8*•	25-19	25-20*•	25-24	25-29
No. of Contacts	8 #8 Coax/Twinax	19 #12	3 #8 Twinax, 13 #16, 4 #12 Coax, 10 #20	12 #16, 12 #12	29 #16
Service Ratings	Coax	I	N	I	I

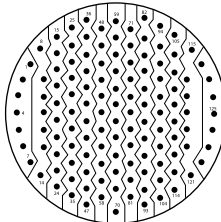
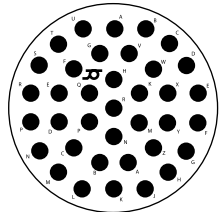
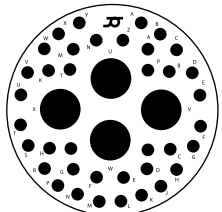
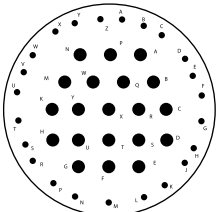
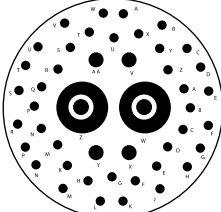
					
Series III	25-35	25-37	25-42	25-43	25-46
Series II	24-35†	-	-	-	-
Series I	25-35	25-37*•	25-42*•	25-43	25-46
No. of Contacts	128 #22D	37 #16	38 #20, 4 #8 Coax	23 #20, 20 #16	40 #20, 4 #16, 2 #8 coax
Service Ratings	M	I	I, Coax	I	I

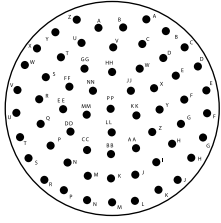
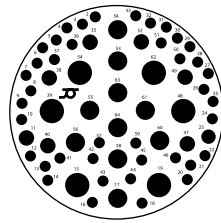
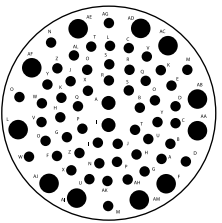
			
Series III	25-61	25-64*	25-66*
Series II	24-61†	-	-
Series I	25-61	25-64*	25-66*
No. of Contacts	61 #20	40 #22D, 8 #20, 10 #16, 6 #12	53 #22D, 2 #20, 11 #16
Service Rating	I	I	I

Please consult factory for availability of layouts not shown.

Contacts-Pin (Series I/II/III)

MIL-C-39029/58

KJL/KJ/KJA

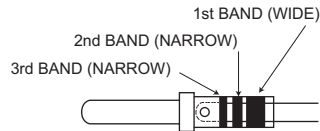

Contact Size	1	Color Bands 2	3	Cannon Part Number	M39029 Military Part Number
22D	Orange	Blue	Black	980-0008-878	M39029/58-360
20	Orange	Blue	Orange	980-0008-879	M39029/58-363
16	Orange	Blue	Yellow	980-0008-880	M39029/58-364
12	Orange	Blue	Green	980-0008-881	M39029/58-365

Contact Size	Cannon Part Number	Cable Accomodations
8 Coax	249-2196-000	RG-180
	249-2196-001	RG-174, 179, 316
	249-2196-002	RG-142
8 Twinax	980-1000-012	M17/176-00002
12 Coax	980-1000-016	RG-174, 179, 316

Contacts-Socket (Series II)

MIL-C-39029/57

KJ

Manufacture identification Code Area - Typical all contacts

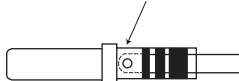

Contact Size	1	Color Bands 2	3	Cannon Part Number	M39029 Military Part Number
22D	Orange	Green	Yellow	980-0008-874	M39029/57-354
20	Orange	Green	Violet	980-0008-875	M39029/57-357
16	Orange	Green	Gray	980-0008-876	M39029/57-358
12	Orange	Green	White	980-0008-877	M39029/57-359

Contacts-Socket (Series I & III)

MIL-C-39029/56

KJL/KJA

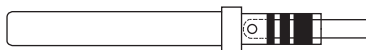

Contact Size	1	Color Bands 2	3	Cannon Part Number	M39029 Military Part Number
22D	Orange	Yellow	Gray	980-0008-870	M39029/56-348
20	Orange	Green	Brown	980-0008-871	M39029/56-351
16	Orange	Green	Red	980-0008-872	M39029/56-352
12	Orange	Green	Orange	980-0008-873	M39029/56-353

Contact Size	Cannon Part Number	Cable Accomodations
8 Coax	249-2195-000	RG-180
	249-2195-001	RG-174, 179, 316
	249-2195-002	RG-142
8 Twinax	980-1000-013	M17/176-00002
12 Coax	980-1000-015	RG-174, 179, 316

Contact Sealing Bushings

Size 8 Twinax Sealing Bushing 321-1035-000
Used with the Twinax contact in Twinax layouts for sealing cable size M17/176-00002

Size 8 Coax Sealing Bushing 321-1034-001
Used with the Coax contact in Twinax layouts for sealing cable size RG-180



Twinax Grommet



Coax Grommet

Contact Sealing Bushing Sequence into Twinax Grommet (Bushing only used with Twinax grommet)

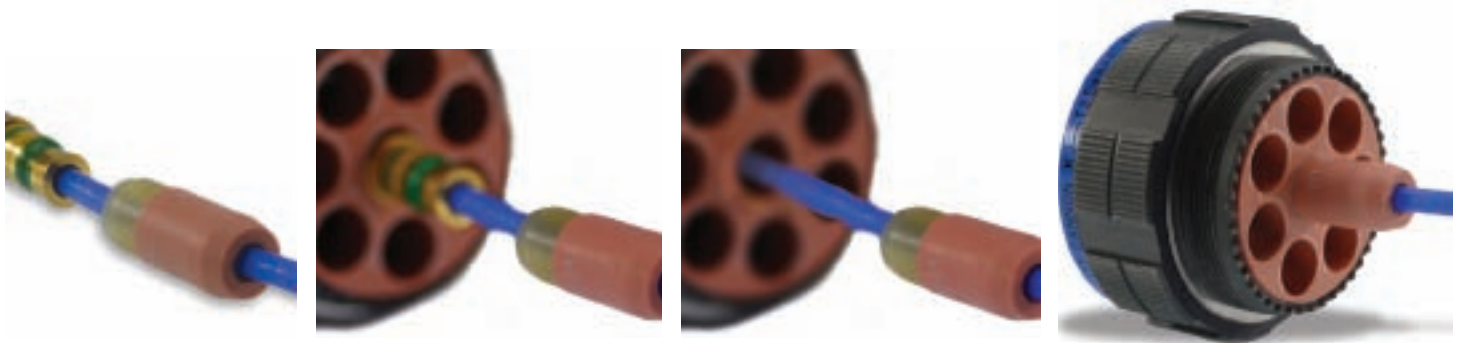

Contacts-Printed Circuit Board

PIN PRINTED CIRCUIT CONTACT EXTENSION FROM REAR OF CONNECTOR (MAX / MIN)

PC CONTACT PART NUMBER	CONTACT SIZE	TAIL DIA. ±.001	MS27466 MS27467 KJL0 / KJL6	MS27656 MS27468 KJL3 / KJL7	MS27505E KJL5E	MS27472 MS27474 KJ0 / KJ7	MS27499E MS27508E KJ2E / KJ5E	MS27513E MS27497 / NO MS KJ2R / KJ3 / KJ5R	MS27473 MS27484 KJ6 / KJG6	D38999/20 KJA0	D38999/26 KJA6	D38999/24 KJA7 (9-17)	D38999/24 KJA7 (19-25)
030-2097-002	22D	0.020	0.261 0.189	0.244 0.176	0.408 0.376	0.264 0.226	0.408 0.376	0.264 0.226	0.264 0.226	0.262 0.200	0.266 0.194	0.280 0.216	0.258 0.198
030-2097-006	22D	0.020	0.069 N/A	0.052 N/A	0.216 0.184	0.072 0.034	0.216 0.184	0.072 0.034	0.072 0.034	0.070 0.008	0.074 0.002	0.088 0.024	0.066 0.006
030-2097-008	22D	0.020	0.216 0.144	0.199 0.131	0.363 0.331	0.219 0.181	0.363 0.331	0.219 0.181	0.219 0.181	0.217 0.155	0.221 0.149	0.235 0.171	0.213 0.153
030-2097-015	22D	0.020	0.293 0.221	0.276 0.208	0.440 0.408	0.296 0.258	0.440 0.408	0.296 0.258	0.296 0.258	0.294 0.232	0.298 0.226	0.312 0.248	0.290 0.230
030-1997-006	20	0.025	0.166 0.094	0.149 0.081	0.313 0.281	0.169 0.131	0.313 0.281	0.169 0.131	0.169 0.131	0.167 0.105	0.171 0.099	0.185 0.121	0.163 0.103
030-1997-022	20	0.025	0.281 0.209	0.264 0.196	0.428* 0.396*	0.284 0.246	0.428* 0.396*	0.284 0.246	0.284 0.246	0.282 0.220	0.286 0.214	0.300 0.236	0.278 0.218
030-1997-030	20	0.019	0.364 0.292	0.347 0.279	0.511 0.479	0.367 0.329	0.511 0.479	0.367 0.329	0.367 0.329	0.365 0.303	0.369 0.297	0.383 0.319	0.361 0.301
030-1995-023	16	0.062	0.278 0.206	0.261 0.193	0.425 0.393	0.281 0.243	0.425 0.393	0.281 0.243	0.281 0.243	0.279 0.217	0.283 0.211	0.297 0.233	0.275 0.215
030-1995-024	16	0.062	0.118 0.046	0.101 0.033	0.265 0.233	0.121 0.083	0.265 0.233	0.121 0.083	0.121 0.083	0.119 0.057	0.123 0.051	0.137 0.073	0.115 0.055

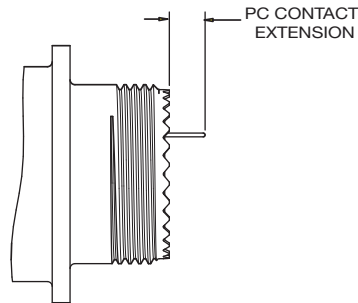

(KJL0/3/6/7 & KJA0/6/7)

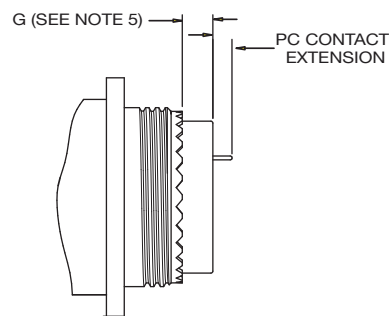

(KJL5E, KJ0/2E/2R/3/5E/5R/6/7, & KJG6)

SOCKET (SERIES II) PRINTED CIRCUIT CONTACT EXTENSION FROM REAR OF CONNECTOR (MAX / MIN)

PC CONTACT PART NUMBER	CONTACT SIZE	TAIL DIA. ±.001	MS27472 MS27474 KJ0 / KJ7	MS27499E MS27508E KJ2E / KJ5E	MS27513E MS27497 / NO MS KJ2R / KJ3 / KJ5R	MS27473 MS27484 KJ6 / KJG6
031-1186-006	22D	0.020	0.179 0.141	0.323 0.291	0.179 0.141	0.179 0.141
031-1186-011	22D	0.020	0.109 0.071	0.253 0.221	0.109 0.071	0.109 0.071
031-1186-013	22D	0.020	0.217 0.179	0.361 0.329	0.217 0.179	0.217 0.179
031-1186-021	22D	0.020	0.262 0.224	0.406 0.374	0.262 0.224	0.262 0.224
031-1124-021	20	0.025	0.247 0.209	0.391* 0.359*	0.247 0.209	0.247 0.209
031-1123-007	16	0.062	0.101 0.063	0.245 0.213	0.101 0.063	0.101 0.063

SOCKET (SERIE I & III) PRINTED CIRCUIT CONTACT EXTENSION FROM REAR OF CONNECTOR (MAX / MIN)

PC CONTACT PART NUMBER	CONTACT SIZE	TAIL DIA. ±.001	MS27466 MS27467 KJL0 / KJL6	MS27656 MS27468 KJL3 / KJL7	MS27505E KJL5E	D38999/20 KJA0	D38999/26 KJA6	D38999/24 KJA7 (9-17)	D38999/24 KJA7 (19-25)
031-1147-014	22D	0.021	0.244 0.172	0.227 0.159	0.391* 0.359*	0.245 0.183	0.249 0.177	0.263 0.199	0.241 0.181
031-1147-039	22D	0.020	0.168 0.096	0.151 0.083	0.315* 0.283*	0.169 0.107	0.173 0.101	0.187 0.123	0.165 0.105
031-1147-040	22D	0.020	0.438 0.366	0.421 0.353	0.585* 0.553*	0.439 0.377	0.443 0.371	0.457 0.393	0.435 0.375
031-1124-040	20	0.025	0.486 0.414	0.469 0.401	0.633 0.601	0.487 0.425	0.491 0.419	0.505 0.441	0.483 0.423
031-1123-020	16	0.029	0.272 0.200	0.255 0.187	0.419 0.387	0.273 0.211	0.277 0.205	0.291 0.227	0.269 0.209

NOTES: UNLESS OTHERWISE SPECIFIED.

1. PC CONTACTS HAVE GOLD PLATING OVER SUITABLE UNDERPLATE PER MIL-C-39029 SPECIFICATION.
2. PC CONTACT EXTENSIONS APPLY TO ITT CANNON CONNECTORS ONLY FOR ALL SHELL SIZES.
3. N/A INDICATES NO EXTENSION.
4. * INDICATES PC TAIL WITH SHANK EXTENDING FROM REAR OF CONNECTOR.
5. G DIM. IS .031 +/- .016 FOR KJL5E AND .120 +/- .030 (SHELL SIZES 8 THRU 22) AND .090 +/- .050 (SHELL SIZE 24) FOR KJ0/2E/2R/3/5E/5R/6/7 & KJG6.
6. FOR OTHER SPECIFIC PC CONTACT DATA, CONSULT ITT EC, SANTA ANA, CA, USA.



Dimensions shown in mm
Specifications and dimensions subject to change

www.ittcannon.com

Wire Sizes and Diameters

Contact Size	Wire size (AWG)	Finished wire outside dimensions	
		Minimum	Maximum
22D	28, 26, 24, 22	0.030	0.054
22M*	28, 26, 24	0.030	0.050
22*	26, 24, 22	0.034	0.060
20	24, 22, 20	0.040	0.083
16	20, 18, 16	0.065	0.109
12	14, 12	0.097	0.142
8 Coax	RG-180	0.136	0.146
8 Twinax	M17/176-00002	0.124	0.134
12 Coax	RG174, 179, 316	0.094	0.102

*For reference only

Recommended Jam Nut Torque Values

Series II		Series I & III	
Shell Size	Inch-Pounds	Shell Size	Inch-Pounds
8	46/50	9	30/36
10	55/60	11	40/46
12	70/75	13	55/60
14	80/85	15	70/75
16	90/95	17	80/85
18	100/110	19	90/95
20	110/120	21	100/110
22	120/130	23	110/120
24	140/150	25	120/130

Coupling Nut Torque Values (Series I, II and III)

Maximum engagement and disengagement		Minimum disengagement	
Shell Size	Inch Pound	Shell Size	Inch Pound
8	8	8	2
9	8	9	2
10	12	10	2
11	12	11	2
12	16	12	2
13	16	13	2
14	20	14	4
15	20	15	3
16	24	16	4
17	24	17	3
18	28	18	5
19	28	19	3
20	32	20	6
21	32	21	5
22	36	22	7
23	36	23	5
24	36	24	7
25	40	25	5

Backshell - Type E (Straight), Series II only

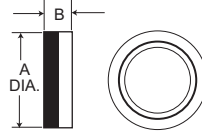

Shell Size		
Series II	A Dia. Max.	B Dia. Max.
8	.580 (14.73)	.328 (8.33)
10	.705 (17.91)	.328 (8.33)
12	.830 (21.08)	.328 (8.33)
14	.955 (24.26)	.328 (8.33)
16	1.080 (27.32)	.328 (8.33)
18	1.205 (30.61)	.328 (8.33)
20	.330 (33.78)	.328 (8.33)
22	1.455 (36.96)	.328 (8.33)
24	1.555 (39.50)	.270 (6.86)

How To Order

Shell Size	Finishes			
	A	B	C	N
Series II	Cadmium/Nickel-Clear Part Number	Cadmium/Nickel-O.D Part Number	Anodic Non-Cond. Part Number	Electroless Nickel Part Number
8	057-0776-000	057-0862-000	057-0819-000	057-0776-002
10	057-0777-000	057-0863-000	057-0820-000	057-0777-002
12	057-0778-000	057-0864-000	057-0821-000	057-0778-002
14	057-0779-000	057-0846-000	057-0822-000	057-0779-002
16	057-0780-000	057-0847-000	057-0823-000	057-0780-002
18	057-0781-000	057-0848-000	057-0824-000	057-0781-002
20	057-0782-000	057-0849-000	057-0825-000	057-0782-002
22	057-0783-000	057-0850-000	057-0826-000	057-0783-002
24	057-0784-000	057-0851-000	057-0827-000	057-0784-002

Backshell - Type F (Cable Clamp)

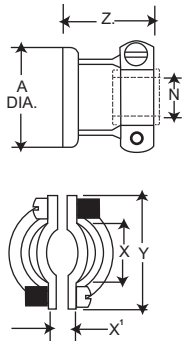

Shell Size							
Series I	Series II	A Max.	N Dia. Max.	X Dia. Min.	X' Dia. Min.	Y Max.	Z Max.
9	8	.508 (14.73)	.135 (3.43)	.234 (5.94)	.187 (4.75)	.829 (21.06)	.813 (20.65)
11	10	.705 (17.91)	.198 (5.03)	.297 (7.54)	.187 (4.75)	.891 (22.63)	.813 (20.65)
13	12	.830 (21.08)	.322 (7.18)	.422 (10.72)	.281 (7.14)	1.016 (25.81)	.813 (20.65)
15	14	.955 (24.26)	.385 (9.78)	.547 (12.89)	.325 (8.26)	1.141 (28.98)	.813 (20.65)
17	16	1.080 (27.43)	.510 (12.95)	.609 (15.47)	.356 (9.04)	1.203 (30.56)	.933 (23.70)
19	18	1.205 (30.61)	.635 (16.13)	.734 (18.64)	.456 (11.58)	1.469 (37.31)	.933 (23.70)
21	20	1.330 (33.78)	.635 (16.13)	.734 (18.64)	.519 (13.18)	1.469 (37.31)	.933 (23.70)
23	22	1.455 (36.96)	.760 (19.30)	.922 (23.42)	.519 (13.18)	1.656 (42.06)	.933 (23.70)
25	24	1.555 (39.50)	.810 (20.57)	.984 (24.99)	.657 (16.69)	1.750 (44.45)	.893 (22.68)

How To Order (MS Version)

MS27506 - A - 8 - 2
Military Designation
 MS27506 Type F Straight with Cable Clamp
Finish
 A - Cad/Nickel (Clear)
 B - Cad/Nickel (O.D)
 F - Nickel (Electroless)
Shell Size
 Series I - 9, 11, 13, 15, 17, 19, 21, 23, 25
 Series II - 8, 10, 12, 14, 16, 18, 20, 22, 24
Adapter
 Geometry - 2

Shell Size				Finishes					
Series I	Series II	MS Part Number	Cannon Part Number	A		B		N	F
				Cannon	MS	Cannon	MS	Cannon	MS
9	8	27506-*8-2	057-3005-***	-012	A	-013	B	-015	F
11	10	27506-*10-2	057-3006-***	-011	A	-012	B	-014	F
13	12	27506-*12-2	057-3007-***	-012	A	-013	B	-015	F
15	14	27506-*14-2	057-3008-***	-010	A	-011	B	-013	F
17	16	27506-*16-2	057-3009-***	-012	A	-013	B	-015	F
19	18	27506-*18-2	057-3010-***	-013	A	-014	B	-016	F
21	20	27506-*20-2	057-3011-***	-011	A	-013	B	-015	F
23	22	27506-*22-2	057-3012-***	-015	A	-016	B	-018	F
25	24	27506-*24-2	057-3013-***	-013	A	-014	B	-017	F

* MS Finish *** Cannon Finish



Backshell - Type P (Potting Boot)

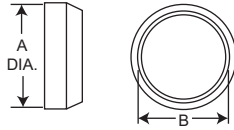

Shell Size			
Series I	Series II	A Dia. Max.	B Dia. Max.
9	8	.598 (15.19)	.434 (11.02)
11	10	.723 (18.36)	.548 (13.92)
13	12	.847 (21.51)	.673 (17.09)
15	14	.969 (24.61)	.798 (20.27)
17	16	1.087 (27.61)	.899 (22.83)
19	18	1.211 (30.76)	1.024 (26.01)
21	20	1.336 (33.93)	1.141 (29.98)
23	22	1.461 (37.11)	1.274 (32.36)
25	24	1.586 (40.28)	1.399 (35.53)

How To Order (MS Version)

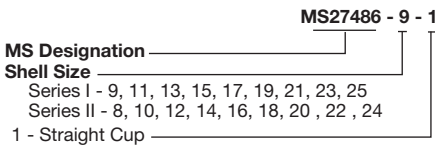

NOTE: When ordering the MS version you must specify both MS numbers for the Potting Boot and the Adapter Ring.

Shell Size		MS27486 Part Number	Cannon Part Number
Series I	Series II		
9	8	27486**-1	040-0185-000
11	10	27486**-1	040-0169-000
13	12	27486**-1	040-0170-000
15	14	27486**-1	040-0171-000
17	16	27486**-1	040-0172-000
19	18	27486**-1	040-0173-000
21	20	27486**-1	040-0174-000
23	22	27486**-1	040-0175-000
25	24	27486**-1	040-0176-000

** Specify applicable Series I or II, shell size.

Potting Boot Adapter Ring

How To Order (MS Version)

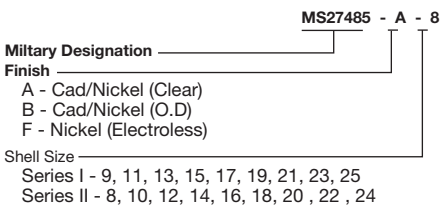

NOTE: When ordering the MS version you must specify both MS numbers for the Potting Boot and the Adapter Ring.

Shell Size		Finishes							
Series I	Series II	MS27485 Part Number	Cannon Part Number	A Cadmium/Nickel		B Cadmium/Nickel-O.D		N Electroless	F Nickel
				Cannon	MS	Cannon	MS	Cannon	MS
9	8	27485*-**	237-0887-***	-000	A	-001	B	-002	F
11	10	27485*-**	237-0874-***	-000	A	-001	B	-002	F
13	12	27485*-**	237-0875-***	-000	A	-001	B	-002	F
15	14	27485*-**	237-0876-***	-000	A	-001	B	-002	F
17	16	27485*-**	237-0877-***	-000	A	-001	B	-002	F
19	18	27485*-**	237-0878-***	-000	A	-001	B	-002	F
21	20	27485*-**	237-0879-***	-000	A	-001	B	-002	F
23	22	27485*-**	237-0880-***	-000	A	-001	B	-003	F
25	24	27485*-**	237-0881-***	-000	A	-001	B	-003	F

* MS Finish
 ** Specify applicable Series I or II shell size
 *** Cannon Finish

Wire Sealing Plugs

Series III Size	Series I & II Size	Part Number		Color Code
		Cannon	MS27488	
22D	22D	225-1013-000	MS27488-22-1	Black
22M*	22M*	225-1013-000	MS27488-22-1	Black
-	22*	225-1013-000	MS27488-22-1	Black
20	20	225-0070-000	MS27488-20-1	Red
16	16	225-0071-000	MS27488-16-1	Blue
12	12	225-0072-000	MS27488-12-1	Yellow

Wire sealing plugs meet MS27488 standards. The plugs are color coded according to size for easy identification. Wire sealing plugs may be ordered separately.
 * For reference only

Tools - Crimp



M22520/1-01

CBT-530

M22520/2-01

CBT-565

Contact Size	Pin Contact Series I/II/III		Socket Contact Series II		Socket Contact Series I & III	
	Crimp Tool Part Number	Locator or Turret Part Number	Crimp Tool Part Number	Locator or Turret Part Number	Crimp Tool Part Number	Locator or Turret Part Number
22D or 22M*	M22520/2-01	M22520/2-09	M22520/2-01	M22520/2-06	M22520/2-01	M22520/2-07
22*	M22520/2-01	M22520/2-09	M22520/2-01	M22520/2-06	M22520/2-01	M22520/2-07
20	M22520/1-01	M22520/1-04 OR TH 187	M22520/1-01	M22520/1-04	M22520/1-01	M22520/1-04
16	M22520/1-01	M22520/1-04 OR TH 187	M22520/1-01	M22520/1-04	M22520/1-01	M22520/1-04
12	M22520/1-01	M22520/1-04	M22520/1-01	M22520/1-04	M22520/1-01	M22520/1-04
8 Coax Inner Conductor	Crimp Tool	Crimp Tool Locator	Outer Conductor		Crimp Tool	Crimp Tool Locator
RG180	M22520/2-01	995-002-268-268	RG180		M22520/2-501	M22520/2-5-39B
RG 174, 179, 310	M22520/2-01	995-002-268-268	RG 174, 179, 310		M22520/2-501	M22520/2-5-37B
RG 142	M22520/2-01	995-002-268-268	RG 142		M22520/2-501	M22520/2-5-19B
12 Coax Inner Conductor	Crimp Tool	Crimp Tool Locator	Outer Conductor		Crimp Tool	Crimp Tool Locator
RG174, 316	M22520/2-01	M22520/2-34	RG174, 316		M22520/31-01	M22520/
8 Twinax	Crimp Tool	Crimp Tool Locator				
Center Contact	M22520/2-01	K709				
Intermediate Contact	M22520/5-01	Y631 Die Closure B				
Outer Contact	M22520/5-01	Y631 Die Closure A				

* For reference only

Tools - Plastic



Insertion/Extraction

Contact Size	Cannon Description	Cannon Part Number	M81969 Part Number	Superseded Military Part Number	Insertion Color Tip	Extraction Color Tip
22D	CIET-22D-01	274-7048-000	M81969/14-01	MS27534-22D	Green	White
22M*	CIET-22D-01	274-7048-000	M81969/14-01	MS27534-22D	Green	White
20	CIET-22-10	274-7001-000	M81969/14-10	MS27534-20	Red	Orange
16	CIET-16-03	274-7002-000	M81969/14-03	MS27534-16	Blue	White
12	CIET-12-04	274-7003-000	M81969/14-04	MS27534-12	Yellow	White
8 Coax/Twinax	CET8-T	323-7004-001	—	—	—	—
12 Coax	CIET-12-04	274-7003-000	M81969/14-04	MS27534-12	Yellow	White

Insertion tool not required for size 8

Tools - Metal (MS)



Insertion



Extraction

Contact Size	Insertion			Extraction			
	MS27495 Part Number	ITT CANNON Part Number	Color Band	MS27495 Part Number	ITT CANNON Part Number	No.1 Color Band	No.2
22D OR 22M*	MS27495 A22M	995-0001-718	Black	MS27495 R22M	995-0001-719	Black	White
22*	MS27495 A22	995-0001-720	Brown	MS27495 R22	995-0001-721	Brown	White
20	MS27495 A20	995-0001-716	Red	MS27495 R20	995-0001-717	Red	White
16	MS27495 A16	995-0001-732	Blue	MS27495 R16	995-0001-731	Blue	White

Band No. 1 indicates tool size.
Band No. 2 indicates removal tool.
* For reference only



Dimensions shown in mm
Specifications and dimensions subject to change

www.ittcannon.com

Assembly Instructions

Wire Stripping

Strip insulation from end of wire to be crimped. (See table for proper stripping dimensions.) Do not cut or damage wire strands.



Wire Size	A
22D or 22M*	.125 (3.18)
20	.188 (4.77)
16	.188 (4.77)
12	.188 (4.77)

* For reference only

Contact Crimping

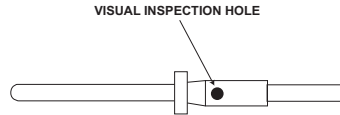

1. Insert stripped wire into contact crimp pot. Wire must be visible thru inspection hole.



2. Using correct crimp tool and locator, cycle the tool once to be sure the indentors are open. Insert contact and wire into locator. Squeeze tool handles firmly and completely to insure a proper crimp. The tool will not release unless the crimp indentors in the tool head have been fully actuated.



3. Release crimped contact and wire from tool. Be certain the wire is visible thru inspection hole in contact.

Contact Insertion



1. Remove hardware from plug or receptacle and slip over wire bundle in proper order for reassembly.



2. Using proper plastic or metal insertion tool for corresponding contact, position wire in tip of the tool so that the tool tip butts up against the contact shoulder.



3. Press tool against contact shoulder and, with firm and even pressure, insert wired contact and tool tip into center contact cavity. A slight click may be heard as metal retaining tines snap into place behind contact shoulder.



4. Remove tool and pull back lightly on wire to make sure contact is properly seated. Repeat operation with remainder of contacts to be inserted, beginning with the center cavity and working outward in alternating rows.



5. After all contacts are inserted, fill any empty cavities with wire sealing plugs, Resemble plug or receptacle hardware.

Contact Extraction



1. Remove hardware from plug or receptacle and slide hardware back along wire bundle.



2. Using plastic or metal extraction tool with proper color code corresponding to contact size, place wire in tool.



3. Insert tool into contact cavity until tool tip bottoms against the contact shoulder, expanding clip retaining tines.



4. Hold wire firmly in tool and extract wired contact and tool. Repeat operation for all contacts to be extracted.



5. Fill any empty wire cavities with wire sealing plugs, and



6. Reassemble plug or receptacle.

Dimensions shown in mm
Specifications and dimensions subject to change

MIL-DTL-38999 Series I, II, III Connectors

MIL-DTL-38999 Specifications

The following excerpts are some of the parameter requirements of the MIL-DTL-3899 Specification.

Test Description	Paragraph Reference	Requirements																																																																								
Contact Retention	4 5 19	After preloading to 3 pounds maximum, the force shall be applied at a rate of approximately 1 pound per second and maintained at full load for 5-10 seconds. No damage to contacts or insert shall result nor shall the contacts be dislocated from their normal position in the connector more than 0.012 inch under the given load. Failure to meet these requirements shall be cause for rejection. <table border="1" style="margin-left: auto; margin-right: auto;"> <thead> <tr> <th>Contact Size</th> <th>22M*</th> <th>22D</th> <th>22*</th> <th>20</th> <th>18</th> </tr> </thead> <tbody> <tr> <td>Loads in Pounds ± 10%</td> <td>10</td> <td>10</td> <td>10</td> <td>15</td> <td>25</td> </tr> </tbody> </table>	Contact Size	22M*	22D	22*	20	18	Loads in Pounds ± 10%	10	10	10	15	25																																																												
Contact Size	22M*	22D	22*	20	18																																																																					
Loads in Pounds ± 10%	10	10	10	15	25																																																																					
Coupling Torque	4 5 6	For qualification testing, mating halves shall be coupled and uncoupled, measuring the torques necessary. The torques required to couple and uncouple mating connector halves shall fall within the limits specifications as follows: <table border="1" style="margin-left: auto; margin-right: auto;"> <thead> <tr> <th colspan="3">Torque</th> <th colspan="3">Torque</th> <th colspan="3">Torque</th> <th colspan="3">Torque</th> </tr> <tr> <th>Shell Size</th> <th>Max.</th> <th>Min.</th> <th>Shell Size</th> <th>Max.</th> <th>Min.</th> <th>Shell Size</th> <th>Max.</th> <th>Min.</th> <th>Shell Size</th> <th>Max.</th> <th>Min.</th> </tr> </thead> <tbody> <tr> <td>8/9</td> <td>8</td> <td>2</td> <td>14</td> <td>20</td> <td>4</td> <td>18</td> <td>28</td> <td>5</td> <td>22</td> <td>36</td> <td>7</td> </tr> <tr> <td>10/11</td> <td>12</td> <td>2</td> <td>15</td> <td>20</td> <td>3</td> <td>19</td> <td>28</td> <td>3</td> <td>23</td> <td>36</td> <td>5</td> </tr> <tr> <td>12</td> <td>16</td> <td>2</td> <td>16</td> <td>24</td> <td>4</td> <td>20</td> <td>32</td> <td>6</td> <td>24</td> <td>36</td> <td>7</td> </tr> <tr> <td>13</td> <td>16</td> <td>2</td> <td>17</td> <td>24</td> <td>3</td> <td>21</td> <td>32</td> <td>5</td> <td>25</td> <td>40</td> <td>5</td> </tr> </tbody> </table>	Torque			Torque			Torque			Torque			Shell Size	Max.	Min.	Shell Size	Max.	Min.	Shell Size	Max.	Min.	Shell Size	Max.	Min.	8/9	8	2	14	20	4	18	28	5	22	36	7	10/11	12	2	15	20	3	19	28	3	23	36	5	12	16	2	16	24	4	20	32	6	24	36	7	13	16	2	17	24	3	21	32	5	25	40	5
Torque			Torque			Torque			Torque																																																																	
Shell Size	Max.	Min.	Shell Size	Max.	Min.	Shell Size	Max.	Min.	Shell Size	Max.	Min.																																																															
8/9	8	2	14	20	4	18	28	5	22	36	7																																																															
10/11	12	2	15	20	3	19	28	3	23	36	5																																																															
12	16	2	16	24	4	20	32	6	24	36	7																																																															
13	16	2	17	24	3	21	32	5	25	40	5																																																															
Durability	4 5 7	Connector halves shall be mated and unmated 250 times for Series II with ground fingers and 500 times for Series I and III at a rate not exceeding 300 cycles per hour. The test may be performed by hand or by mechanical means, but the coupling ring shall be operated as in normal service. Failure to complete this test because of mechanical malfunction shall be cause for rejection.																																																																								
Insulation Resistance	4 5 9	An insulation resistance test shall be performed on unmated connectors in accordance with MIL-STD-202, Method 302, Test condition B. Measurement shall be made between three pairs of adjacent contacts and the shell. Failure to meet the minimum requirement of 50,000 megohms for Classes E, P, F, R, and T shall be cause for rejection.																																																																								
Vibration	4 5 22	Wired, mated connectors shall be subjected to the vibration test of MIL-STD-202, Method 214, Test Condition II, except that the duration shall be one hour in each plane. Receptacles shall be mounted on the vibration fixture by normal means. All contacts shall be wired in a series circuit and 100-500 milliamperes of current shall be allowed to flow through the series circuit during vibration. Suitable means shall be employed to monitor the current flow and to indicate any discontinuity of more than 1 microsecond. The wire bundle shall be clamped to the nonvibrating points at least 8 inches from the rear of the connector. Current discontinuity of 1 microsecond or more, disengagement of the mated connectors, evidence of cracking, breaking, or loosening of parts shall be cause for rejection.																																																																								
Shock	4 5 23	Wired mated connectors shall be subjected to one shock in each direction in each of three mutually perpendicular axes. The pulse shall be approximate half sine wave of 300g ± 15% magnitude with a duration of 3 ± 1 milliseconds. Receptacles shall be mounted on a shock fixture by normal means. All contacts shall be wired in a series circuit and 100-150 ma. of current shall flow through the series circuit during shock. Suitable means shall be employed to monitor the current flow and to indicate any discontinuity of more than 1 microsecond. The wire bundle shall be clamped to fixed points at least 8 inches from the rear of the connector. Current discontinuity of 1 microsecond or more, disengagement of the mated connectors, evidence of cracking, breaking, or loosening of parts shall be cause for rejection.																																																																								
Thermal Shock	4 5 4	Unmated receptacles shall be subjected to 10 cycles of thermal shock in the following manner: Step a The receptacle shall be suspended for 10 ± 0 minutes in the center of a cold water bath with a volume of approximately one cubic foot. No dimension of the bath shall be less than 10 inches. The water temperature shall not exceed 4°C (39.20°F). Step b The receptacle shall be suspended for 10 ± 0 minutes in the center of a hot water bath with a volume of approximately one cubic foot. No dimension of the bath shall be less than 10 inches. The water temperature shall be not less than 94°C (201°F). The time of transfer from one bath to the other shall not exceed 5 seconds. At the end of the tenth cycle, the receptacle shall have the excess moisture shaken off and shall then be dried in a forced air oven at 66±5°C for 15 ± 1 minutes. Any evidence of damage resulting from this test shall be cause for rejection.																																																																								
Altitude Immersion	4 5 8	Mated connectors shall be placed in a container of water at approximately 20°C and placed in an altitude chamber. All wire ends shall be located within the chamber and exposed to the chamber atmosphere, but not submerged. The exposed wire ends shall not be sealed. A quantity of salt, 5 percent by weight, shall be added to make the water conductive. The chamber pressure shall then be reduced to approximately one inch of mercury and maintained for thirty minutes. The chamber pressure shall then be slowly returned to atmospheric. This shall be considered one cycle. Two additional cycles shall be performed. At the end of the last cycle, while the mated connectors are still submerged, the Insulation Resistance Test (room temperature), and the High Potential Test (sea level voltages) shall be performed upon the same circuits. Failure to meet an insulation resistance minimum of 2,000 megohms or any evidence of dielectric breakdown or -flashover shall be cause for rejection.																																																																								
Solvent Immersion	4 5 29	Unmated connectors shall be immersed fully in the applicable fluid specified below for 20 hours. After removal from the fluid, each connector shall remain for one hour in free air at room temperature. a.) Jet fuel JP-4 to MIL-J-5624 b.) Aircraft lubricating oil to MIL-L-9236																																																																								
Corrosion	4 5 12	Unmated connectors and individual contact samples shall be subjected to the soft spray of MIL-STD-202, Method 101, Test Condition 8 (tin plated, Class Y receptacles-24 hours). Immediately after exposure, the surfaces of the specimens shall be thoroughly washed in tap water and dried in a circulatory oven at a temperature of 38 ± 3°C (100°F) for a period of approximately 12 hours. Any exposure of basis metal as a result of this test, shall be cause for rejection.																																																																								
Dynamic Salt Spray	4 5 12 2	(Series I and 11, finish B; Series III, class W). The wired assembled plugs and receptacles shall be mated and unmated 50 cycles at a rate of 300 cycles per hour maximum. The mating and unmating shall be accomplished so that the plug and receptacle are completely separated during each cycle. The connectors shall then be subjected to the salt spray test in accordance with method 1001 of MIL-STD- 1344. The connectors shall be tested for 452 hours mated followed by 48 hours unmated. After the salt spray exposure the remaining number of durability cycles specified in 4.7.7 shall be completed.																																																																								
Temperature Durability	4 5 33	Wired rated connectors shall be subjected to the indicated ambient temperature for a period of 1,000 hours <table border="1" style="margin-left: auto; margin-right: auto;"> <tbody> <tr> <td>Series I and II (finish A)</td> <td>150^{+3°}_{-0°C} (302° F)</td> <td>Series I and II (finish B)</td> <td>175^{+3°}_{-0°C} (347° F)</td> </tr> <tr> <td>Series III (class W)</td> <td>175^{+3°}_{-0°C} (347° F)</td> <td>All other finishes</td> <td>200^{+3°}_{-0°C} (392° F)</td> </tr> </tbody> </table>	Series I and II (finish A)	150 ^{+3°} _{-0°C} (302° F)	Series I and II (finish B)	175 ^{+3°} _{-0°C} (347° F)	Series III (class W)	175 ^{+3°} _{-0°C} (347° F)	All other finishes	200 ^{+3°} _{-0°C} (392° F)																																																																
Series I and II (finish A)	150 ^{+3°} _{-0°C} (302° F)	Series I and II (finish B)	175 ^{+3°} _{-0°C} (347° F)																																																																							
Series III (class W)	175 ^{+3°} _{-0°C} (347° F)	All other finishes	200 ^{+3°} _{-0°C} (392° F)																																																																							

* For reference only



Dimensions shown in mm
 Specifications and dimensions subject to change

www.ittcannon.com

Product Safety Information

THIS NOTE MUST BE READ IN CONJUNCTION WITH THE PRODUCT DATA SHEET/CATALOG. FAILURE TO OBSERVE THE ADVICE IN THIS INFORMATION SHEET AND THE OPERATING CONDITIONS SPECIFIED IN THE PRODUCT DATA SHEET/ CATALOG COULD RESULT IN HAZARDOUS SITUATIONS.

1. MATERIAL CONTENT AND PHYSICAL FORM

Electrical connectors do not usually contain hazardous materials. They contain conducting and non-conducting materials and can be divided into two groups.

- a) Printed circuit types and low cost audio types which employ all plastic insulators and casings.
- b) Rugged, Fire Barrier and High Reliability types with metal casings and either natural rubber, synthetic rubber, plastic or glass insulating materials. Contact materials vary with type of connector and also application and are usually manufactured from either: Copper, copper alloys, nickel, alumel, chromel or steel. In special applications, other alloys may be specified.

2. FIRE CHARACTERISTICS AND ELECTRIC SHOCK HAZARD

There is no fire hazard when the connector is correctly wired and used within the specified parameters. Incorrect wiring or assembly of the connector or careless use of metal tools or conductive fluids, or transit damage to any of the component parts may cause electric shock or burns. Live circuits must not be broken by separating mated connectors as this may cause arcing, ionization and burning. Heat dissipation is greater at maximum resistance in a circuit. Hot spots may occur when resistance is raised locally by damage, e.g. cracked or deformed contacts, broken strands of wire. Local overheating may also result from the use of the incorrect application tools or from poor quality soldering or slack screw terminals. Overheating may occur if the ratings in the product Data Sheet/Catalog are exceeded and can cause breakdown of insulation and hence electric shock. If heating is allowed to continue it intensifies by further increasing the local resistance through loss of temper of spring contacts, formation of oxide film on contacts and wires and leakage currents through carbonization of insulation and tracking paths. Fire can then result in the presence of combustible materials and this may release noxious fumes. Overheating may not be visually

apparent. Burns may result from touching overheated components.

3. HANDLING

Care must be taken to avoid damage to any component parts of electrical connectors during installation and use. Although there are normally no sharp edges, care must be taken when handling certain components to avoid injury to fingers. Electrical connectors may be damaged in transit to the customers, and damage may result in creation of hazards. Products should therefore be examined prior to installation/use and rejected if found to be damaged.

4. DISPOSAL

Incineration of certain materials may release noxious or even toxic fumes.

5. APPLICATION

Connectors with exposed contacts should not be selected for use on the current supply side of an electrical circuit, because an electric shock could result from touching exposed contacts on an unmated connector. Voltages in excess of 30 V ac or 42.5 V dc are potentially hazardous and care should be taken to ensure that such voltages cannot be transmitted in any way to exposed metal parts of the connector body. The connector and wiring should be checked, before making live, to have no damage to metal parts or insulators, no solder blobs, loose strands, conducting lubricants, swarf, or any other undesired conducting particles. Circuit resistance and continuity check should be made to make certain that there are no high resistance joints or spurious conducting paths. Always use the correct application tools as specified in the Data Sheet/Catalog. Do not permit untrained personnel to wire, assemble or tamper with connectors. For operation voltage please see appropriate national regulations.

IMPORTANT GENERAL INFORMATION

(i) Air and creepage paths/Operating voltage. The admissible operating voltages depend on the individual applications and the valid national and other applicable safety regulations.

For this reason the air and creepage path data are only reference values. Observe reduction of air and creepage paths due to PC board and/or harnessing.

(ii) Temperature

All information given are temperature limits. The operation temperature depends on the individual application.

(iii) Other important information

Cannon continuously endeavors to improve their products. Therefore, Cannon products may deviate from the description, technical data and shape as shown in this catalog and data sheets.

“Engineered for life” is a registered trademark of ITT Industries, © 2005. All other trademarks or registered trademarks are property of their respective owners. All data subject to change without notice.

Product Warranty

ITT Industries, Cannon manufactures the highest quality products available in the marketplace; however these products are intended to be used in accordance with the specifications in this publication. Any use or application that deviates from the stated operating specifications is not recommended and may be unsafe. No information and data contained in this publication shall be construed to create any liability on the part of Cannon. Any new issue of this publication shall automatically invalidate and supersede any and all previous issues. A limited warranty applies to Cannon products. Except for obligations assumed by Cannon under this warranty, Cannon shall not be liable for any loss, damage, cost of repairs, incidental or consequential damages of any kind, whether or not based on express or implied warranty, contract, negligence or strict liability arising in connection with the design, manufacture, sale, use or repair of the products. Product availability, prices and delivery dates are exclusively subject to our respective order confirmation form; the same applies to orders based on development samples delivered. This publication is not to be construed as an offer. It is intended merely as an invitation to make an offer. By this publication, Cannon does not assume responsibility or any liability for any patent infringements or other rights of third parties which may result from its use. Reprinting this publication is generally permitted, indicating the source. However, Cannon's prior consent must be obtained in all cases.

Accessories

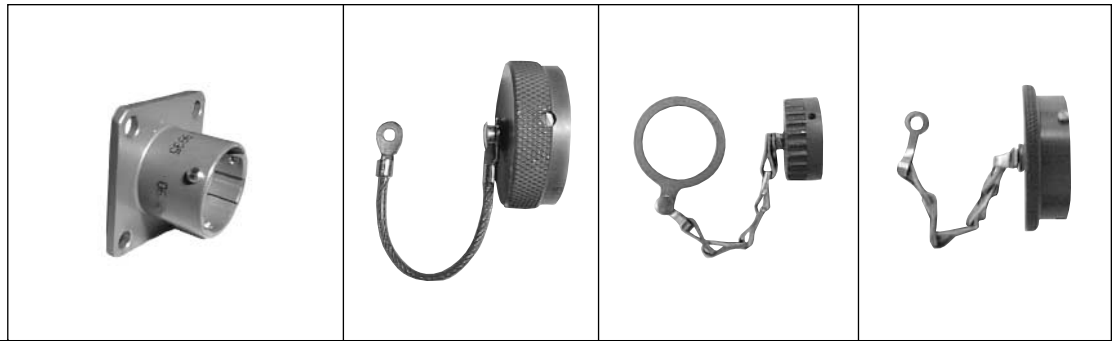

KJL	Dummy Receptacles	Receptacle Dust Caps		Plug Cap
		For Flanged	For Jam Nut	
9	M38999/9-9B	M527502**9CL	M527502**9CN	M527501**9CL
11	M38999/9-11B	M527502**11CL	M527502**11CN	M527501**11CL
13	M38999/9-13B	M527502**13CL	M527502**13CN	M527501**13CL
15	M38999/9-15B	M527502**15CL	M527502**15CN	M527501**15CL
17	M38999/9-17B	M527502**17CL	M527502**17CN	M527501**17CL
19	M38999/9-19B	M527502**19CL	M527502**19CN	M527501**19CL
21	M38999/9-21B	M527502**21CL	M527502**21CN	M527501**21CL
23	M38999/9-23B	M527502**23CL	M527502**23CN	M527501**23CL
25	M38999/9-25B	M527502**25CL	M527502**25CN	M527501**25CL

** Select code for plating

B = Olive Drab Chromate over Cadmium over Nickel (500 Hour Salt Spray)

F = Electroless Nickel (Fluid Resistant)



KJL	Endbells		Cable Range	
	Straight Low Cost	Right Angle Low Cost	Min	Max
9	M85049/49-2-8**	M85049/47-8**	.082 (2.08)	.234 (5.94)
11	M85049/49-2-10**	M85049/47-10**	.082 (2.08)	.234 (5.94)
13	M85049/49-2-12**	M85049/47-12**	.114 (2.90)	.328 (8.33)
15	M85049/49-2-14**	M85049/47-14**	.176 (4.47)	.457 (11.61)
17	M85049/49-2-16**	M85049/47-16**	.238 (6.05)	.634 (16.10)
19	M85049/49-2-18**	M85049/47-18**	.208 (5.28)	.614 (15.60)
21	M85049/49-2-20**	M85049/47-20**	.302 (7.67)	.698 (17.73)
23	M85049/49-2-22**	M85049/47-22**	.302 (7.67)	.823 (20.90)
25	M85049/49-2-24**	M85049/47-24**	.332 (8.43)	.853 (21.67)

** Select code for connector plating

W = Olive Drab Chromate over Cadmium over Nickel (1,000 Hour Salt Spray)

N = Electroless Nickel (Fluid Resistant)

A = Black Anodize

Accessories







Shell Size	Self Locking Endbells		Clamp Range		
	KJL	Straight	Right Angle	Min	Max
9		M85049/49-2S8**	M85049/47S-8**	.098 (2.49)	.234 (5.94)
11		M85049/49-2S10**	M85049/47S-10**	.153 (3.89)	.234 (5.94)
13		M85049/49-2S12**	M85049/47S-12**	.190 (4.83)	.328 (8.33)
15		M85049/49-2S14**	M85049/47S-14**	.260 (6.60)	.457 (11.61)
17		M85049/49-2S16**	M85049/47S-16**	.283 (7.19)	.634 (16.10)
19		M85049/49-2S18**	M85049/47S-18**	.325 (8.25)	.614 (15.60)
21		M85049/49-2S20**	M85049/47S-20**	.343 (8.71)	.698 (17.73)
23		M85049/49-2S22**	M85049/47S-22**	.491 (9.68)	.823 (20.90)
25		M85049/49-2S24**	M85049/47S-24**	.418 (10.62)	.853 (21.67)

** Select code for connector plating

W = Olive Drab Chromate over Cadmium over Nickel (1,000 Hour Salt Spray)

N = Electroless Nickel (Fluid Resistant)

	Sealed	EMI/RFI	S=Straight A=90° B=45°	Orientation	Description
 M85049/62	Y	N	S	Heat Shrink Boot Adapters	Designed for use with straight or right angle shrink boots. A knurled rear section with a boot groove provides an excellent surface for the boot to grab the metal endbell. Available with lock wire and drain holes.
 M85049/35	N	N	S	Extender Back Shell	Non-environmental design for use with jacketed cable allows extra space to break out the wires and still provide strain relief clamping to the outside of the cable jacket.
 M85049/17	Y	Y	S	Extender Back Shell	This EMI/RFI shielding, environmentally sealing endbell features a standard style cable clamp with gland seal at the end of and extender style backshell.
 M85049/29	N	Y	S	Extender Back Shell	This EMI/RFI shielding, non-environmentally sealing endbell features a standard style cable clamp.
 Banding	Y	Y	SAB	Banding Adapter	Banding adapters utilize a band of metal that fastens and grounds cable shields to the outside of endbells. This method of terminating shields has advantages in that they typically use tools to tighten trim the bands. These tools make the termination tight, repeatable, reworkable (if you make a mistake just cut the band off and start again) and facilitates service. Banding adapters help lower the total applied cost by having simpler designs that have fewer parts with uncomplicated assembly procedures.
Custom			SAB	Call Custom Designs Call	If the Military Standard endbells don't fit your needs, just call us and we will customize an endbell solution to fit you. Most of these customized endbells are typically assembled in 4-8 weeks or sooner!