

Powerpole® & Multipole

CONNECTORS | 10 AMPS UP TO 700 AMPS

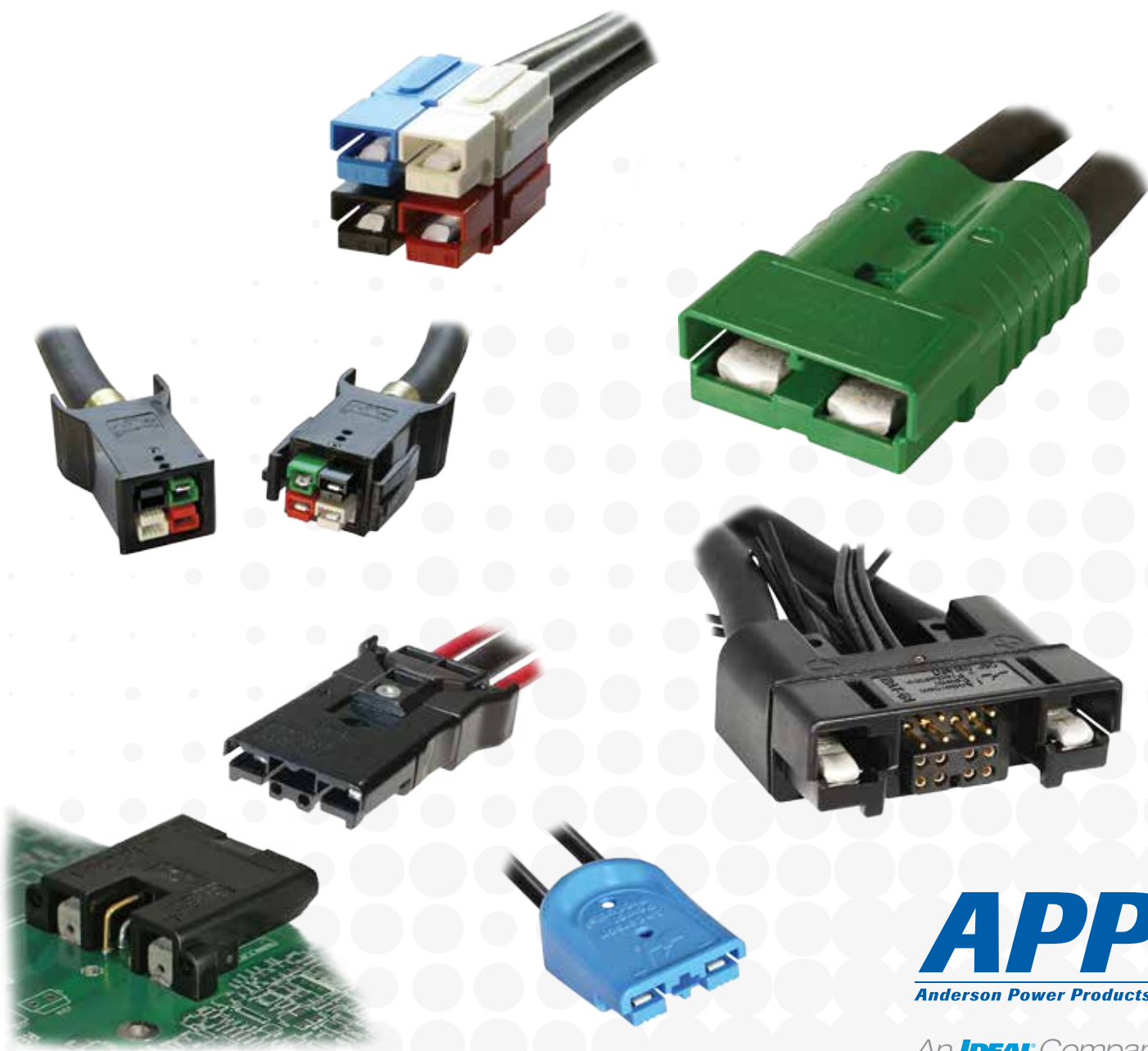

Alternate Energy | Power Electronics | Electric Vehicles | Telecommunications | Industrial | PCB



APP
Anderson Power Products®

An IDEAL Company

Global Presence

Anderson Power Products (Anderson) Has A Global Distribution Network In The Following Countries Along With Many Others:

Argentina, Australia, Belgium, Brazil, Canada, Chile, China, Columbia, Denmark, France, Germany, Greece, Hong Kong, Ireland, Israel, Italy, Japan, Mexico, New Zealand, Norway, Peru, Poland, Portugal, Singapore, Slovenia, South Africa, South Korea, Spain, Switzerland, Thailand, Turkey, United Kingdom and United States.

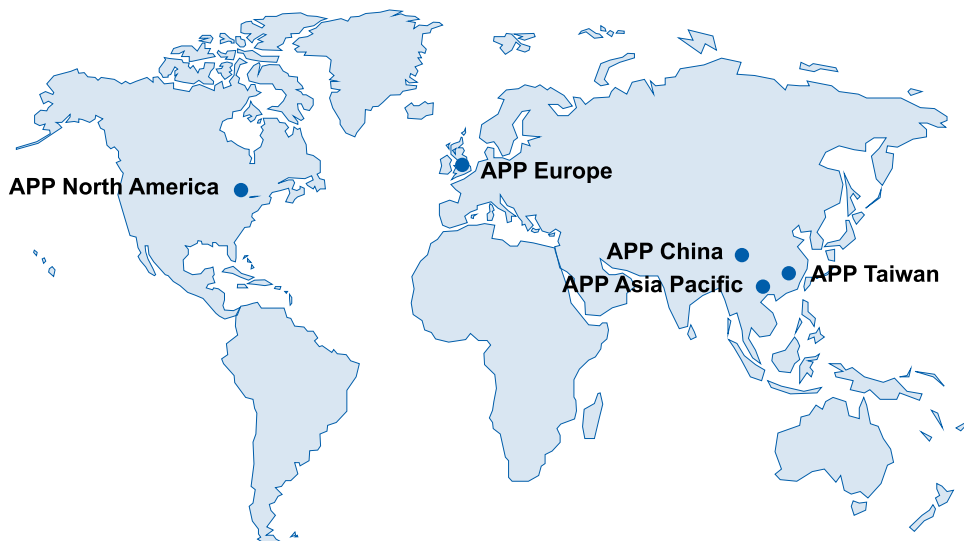

Our philosophy is to provide products and services within the trading markets of our customers. We currently serve our worldwide customer base from customer support and manufacturing facilities in Sterling, MA, U.S.A., Warrington UK for European customers, as well as three Asia Pacific facilities: Shenzhen, China, Shatin Hong Kong and Taichung City 407, Taiwan (R.O.C.).

Today, as a result of innovative design and development, we have evolved into a valued supplier for a wide variety of markets including Back-up Power, Telecom / Datacom, Alternative Energy Generation & Distribution, Medical Equipment, Defense, and the Material Handling Industries.

We have established a reputation for high quality products, on-time deliveries, and excellent customer service. As a result of modern manufacturing techniques and rigorous quality control measures, this assures our customers receive the quality products they deserve.

As a global company dedicated to best environmental practice, we have taken steps to meet the RoHS directive for virtually all products. We look forward to the challenges posed by the new technologies of the future and will continue our century long tradition of design excellence and superior customer support to meet customers' needs.

.....
© 2018 Anderson Power Products, Inc. All rights reserved. This catalog or it's content may be downloaded only for your personal, non-commercial use.

Anderson will use reasonable efforts to include accurate and up-to-date content in the catalog. All product information contained in the catalog including ordering information, illustrations, specifications, and dimensions, are believed to be reliable as of the date of publishing, but is subject to change without notice. Anderson makes no warranty or representation as to its accuracy. Content in the catalog may contain technical inaccuracies, typographical errors and may be changed or updated without notice. Anderson may also make improvements and/or changes to the products and/or to the programs described in the content at any time without notice. Current sales drawings and specifications are available upon request.

Neither Anderson nor any party involved in creating, producing, or delivering this catalog shall be liable for any direct, incidental, consequential, indirect, or punitive damages arising out of your use of this catalog or any errors or omissions in its content.

All product names, including, but not limited to A®, A in circle, Anderson Power Products®, APP®, Powerpole®, SB®, SBE®, SBO®, SBS®, SBX®, SPEC Pak®, Saf-D-Grid®, Power Clip®, Power Drawer®, PowerMod® and the APP Logo are registered trademarks of Anderson Power Products, Inc. Anderson™ is a trademark of Anderson Power Products, Inc.

Index & Product Selector Guide

SECTION 1

- Index & Product Selector 1
- Technical Reference 4
- Glossary 10
- Engineering Reference 12

SECTION 2

- Powerpole® Connectors 16
 - PP15 to PP45 20
 - Powerpole® Pak 23
 - Powerpole® PP75 32
 - Powerpole® PP120 39
 - Powerpole® PP180 43

SECTION 3

- Multipole Connectors 48
 - SBS® Mini 53
 - SBS® 50 & 75 57

- SB®50 67
- SB®120 72
- SB®175 77
- SB®350 82
- SBE®80 / SBO®60 87
- SBE®160 / SBX®175 92
- SBE®320 / SBX®350 98
 - PPMX Auxiliary Holder for
SBO®, SBE® & SBX® 90, 96, 102
- SB® SMART 105

SECTION 4

- Tooling 109

SECTION 5

- Part Number Page Reference 115

	Powerpole® Connector Family	Multipole Connector Family
Page Number	16	48
Amps (UL) Per Pole	Up to 350	Up to 500
Volts (UL) Per Pole	Up to 600	Up to 600
Wire Gauge (AWG)	20 - 3/0	16 - 350 mcm
Wire Gauge (mm²)	0.75 - 85.0	1.3 - 150
Number of Power Circuits	1 / Stackable	2 - 3 / Not Stackable
Ground	•	•
Auxiliary		•
PCB Mount	•	•
Bus Bar	•	•
Panel Mount	•	•
Blind Mate	•	
Hot Plug	•	•
Touch Safe	•	•
Strain Relief	•	•
Polarized Housing	•	•
Mechanically Keyed		•
Latching	•	
Handle		•
Air Supply System		•

Custom Connector Capabilities

We specialize in the design and manufacture of high current connection systems to meet specific customer needs. Our expertise in high amperage connections, multiple types of contact technology, and molded plastic insulators allow us to provide durable, high power connections that fulfill the project requirements of OEM's.

We look forward to working with OEM's on their manufacturing scale projects to provide connector solutions which our current product portfolio may not satisfy. Marketing, Engineering, Quality, Safety Agency, and Manufacturing teams all contribute through the integrated product development process to create and deliver custom connectors that exceed our customers' needs and meet our high standards.

Contact your local customer service representative or regional sales manager to explore how our custom design and manufacturing capabilities can meet your high volume connection needs.

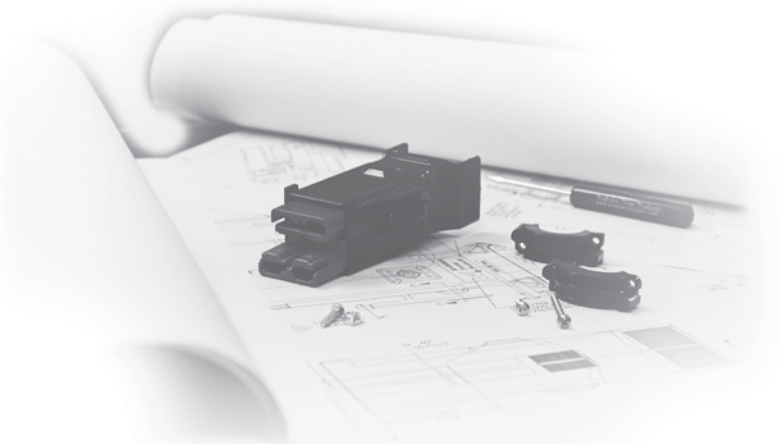

| HOW TO USE THIS CATALOG |

The information in this catalog is provided in layers to allow you to quickly find the information you are looking for.

- 1) Selection Guides are featured at the front of the catalog and at the beginning of each product section to enable quick connector selection by electrical attributes and other features.
- 2) A Technical Reference is provided to give important information common to all connectors in this catalog. Answers to common questions, definitions of terminology, and technical charts are all included.
- 3) Overviews at the beginning of each product main section describe the similarities and call out common features of products within that section.
- 4) Introductions to the features and benefits of each product are supplied at the beginning of each sub-product section (SB®50, SB®120, etc).
- 5) Specifications and Temperature Charts are shown after the main connector components in each sub-product section to provide detailed technical information (SB®50, SB®120, etc).
- 6) Tooling Charts are provided at the end of each connector family (SB®, SBS® etc) to quickly identify the correct tooling.

| PRODUCT SELECTION WORKSHEET |

Prior to selecting an interconnect solution, we recommend you gather the following information. This will aid you in quickly identifying the best product for your particular need.

Amps

Continuous _____ max amps at _____ volts
 Peak _____ max amps _____ seconds

Temperature

Operating _____ Storage _____

Circuit Definition

	Number of Circuits:	Wire Gauge:
Power	_____	_____
Ground	_____	_____
Auxiliary	_____	_____
Other	_____	_____

Application

- PCB to PCB
- Wire to PCB
- Wire to Bus Bar
- Wire to Wire
- Wire to Panel
- Other _____

Mounting Method (if applicable)

- PCB
- Panel
- Blind Mate

Contacts

- Mating Cycles _____
- Individual
- Reeled
- Tin
- Silver
- Gold
- Straight
- Right Angle

Other Features

- Hot Plug
- Touch Safe per _____
- Flame Resistance per _____
- IP rating of _____
- Sequencing
- Strain Relief
- Polarized Housing
- Mechanical Housing Key
- Latching
- Handle
- Other _____

NOTES:	

Technical Reference

| GENERAL APPLICATION NOTES |

There are common considerations when using our connectors. Additional considerations may apply based on the particular connector being used, the application, and conditions in which it's being used. This information is intended to provide a basic understanding and is provided for reference only. Connectors should be assembled and used according to the equipment and the manufacturer's instructions, as well as in compliance with local and international electrical codes.

The maximum amperage ratings provided in the specifications are based on use of our recommended assembly tooling and the maximum wire size for the connector being used. Amperage ratings are based on not exceeding the maximum operating temperature of the connector housing, factoring in an ambient temperature of 25°C or 77°F. A wire with an appropriate insulation temperature rating should be selected to meet or exceed the total connector temperature (heat rise + ambient).

As an example: if the maximum operating temperature for a connector operation is 105°C and the ambient temperature is 25°C, the maximum heat rise attributable to the connector is 105°C - 25°C = 80°C. The expected heat rise based on the connector and wire size used can be estimated using the heat rise charts, but should be confirmed by testing in the specific application with the specific wire to be used.

Connector devices are rated or derated by the wiring configuration and the environment. Factors to be considered include: enclosure characteristics, connector housing and wire insulation characteristics, number of wires in an enclosed area such as a raceway or conduit, as well as the ambient temperature.

Underwriter Laboratories Inc. amperage ratings are based on not exceeding the maximum operating temperature of the connector housing. This means connectors can be extremely hot when used at the UL amperage ratings. For this reason UL amperage ratings should only be applied to connectors when they are used inside an enclosure not accessible to untrained persons. Canadian Standards Association ratings are based on not exceeding a 30°C temperature rise above ambient temperatures. For this reason CSA amp ratings are a good point of reference for connectors that are user operated. APP does not recommend exceeding a 30°C temperature rise above ambient temperatures for connections accessible during operation to untrained persons.

| HOW TO READ TEMPERATURE CHARTS | Temperature rise charts are based on a 25°C ambient temperature.

Temperature Rise at Constant Current Charts

Temperature Rise at Constant Current charts show the associated heat rise as a result of applied current to the connector. An example of the SB[®]50 connector Temperature Rise chart is included to follow along with this explanation.

The chart is based on an ambient temperature of 25°C (77°F room temperature). Accordingly if the temperature °C on the Y axis of the chart is at 30°C, the expected total connector temperature would be 55°C.

Separate curves are shown for #6, #8, #10, and #12 AWG wire. Interpreting the curves, if 50 amps are applied continuously to the connector, the heat rise will be 23°C for #6, 35°C for #8, 55°C for #10, and #12 wire is not suitable for this amperage.

Where T = Temperature, heat rise is expressed as a $\Delta T^{\circ}\text{C}$.
 $T_{\text{ambient}} - T_{\text{ambient}} + \text{heat from applied current} = \Delta T^{\circ}\text{C}$.

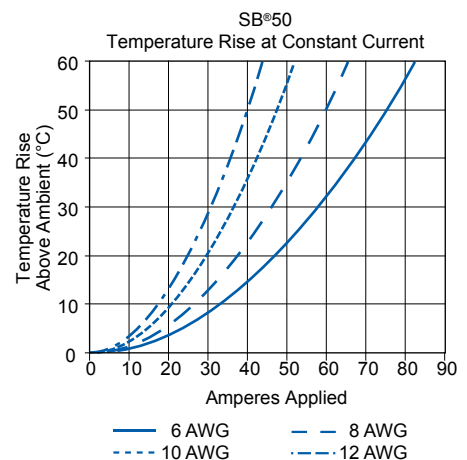

Derating vs. Ambient Temperature Charts

Derating vs. Ambient Temperature charts show the maximum amperage capability of a connector at a given ambient temperature. An example of the SB®50 connector chart is included to follow along with this explanation.

All data points are based on the maximum operating temperature of the connector, most often 105°C or 221°F. Accordingly if the temperature °C on the Y axis of the chart is at 105°C, there is no amperage capability because the connector housing is already at the maximum operating temperature.

Separate curves are shown for #6, #8, #10, and #12 AWG wire. Interpreting the curves, at a 75°C ambient temperature the maximum amperage capability that can be applied continuously to the connector is: 58A for #6, 46A for #8, 37A for #10, and 31A for #12 wire.

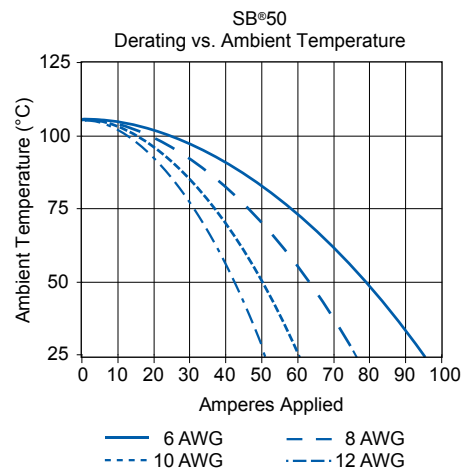

Notes on Temperature Rise Charts

Note that these charts are constructed using calculations based on actual test data. For this reason the chart information may vary slightly from the safety agency ratings. Safety agency ratings and compliance with electrical codes take precedent over these charts. The charts are designed to provide a guideline as to the connectors' capability. Actual results can vary based on the specific wire used, crimp tooling and assembly, as well as the environment the connector is used in.

CSA ratings are based on not exceeding a 30°C temperature rise above ambient or a total temperature of 55°C. This is considered the maximum temperature to safely handle a connector at. UL ratings can be based on the operating temperature limit of the connector. Often for our connectors this is 105°C or an 80°C temperature rise above an ambient temperature of 25°C. To provide a margin of safety, the heat rise charts are limited to a 60°C temperature rise.

| COMPATIBLE WIRES |

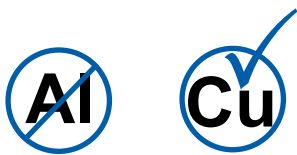

Our connectors are designed to be crimped and/or soldered to multi-stranded copper conductor wires only. Alternate conductor materials including aluminum should not be used. Aluminum conductors crimped into our contacts can result in a galvanic reaction occurring between the aluminum wire and the more cathodic metals used in our contacts including copper, tin, silver, and gold. Additionally softer metals like aluminum flow or loosen from crimps much easier than copper.

Multi-stranded wire is recommended for all our connectors and is required when crimp terminating wires or when a connector with flat wiping contact technology is used (such as Powerpole® and SB®). Solid wires do not adequately compress and retain in crimp barrels after being crimped. For this reason if solid wire is used, it should be with solder termination only.

Solid wires also do not flex and bend as easily as multi-stranded equivalents and can act as a lever arm and impede or alter the natural state of a flat wiping contact in the housing. This impediment or alteration to the flat wiping contact's natural state can cause intermittency and shorts as well as higher resistance and temperature at a given amperage than is shown in the specifications. Mating and unmating forces may also be impacted.

| DIFFERENT CONTACT TECHNOLOGIES |

Flat Wiping:

- Same contacts on the “male” and “female” side reduce inventory costs and increase ease of assembly.
- Low resistance connection has a large conducting surface and a high normal force in comparison to typical pin and socket contacts.
- Sacrificial tip confines damage to non-conducting area when mating or breaking under load.
- Raised surface on the mating side of the contacts secures the connector in the mated condition, limiting the need for latching on outer housings.
- Over wiping design cleans the mating surface when mating and unmating.

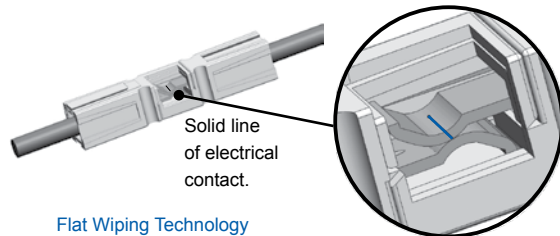

Flat Wiping Technology

- VS -

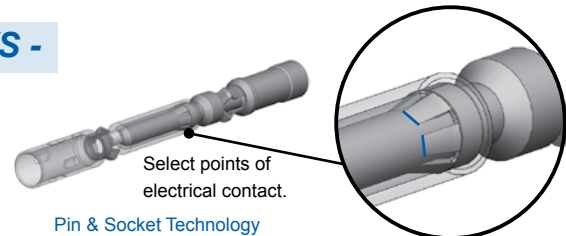

Pin & Socket Technology

Pin & Socket:

- Different contacts on male and female sides. Female socket contacts are typically more expensive than the simple geometries of the pin contacts.
- Often higher resistance than flat wiping connectors of the same wire size and plating due to the reduced mating surface area and lower normal force. Gold plating often used to compensate and minimize resistance.
- Best for compact connection needs such as signal and low power due to static position in housings and symmetrical shape.
- Socket contacts can catch and hold debris inside the socket body causing mating problems.

| USE OF ANDERSON™ CONNECTORS IN APPLICATIONS EXCEEDING 600V |

The approved voltage ratings for our connectors are usually limited by the category under which a safety agency such as UL approves our connector for use. UL typically defers to National Electric Code (NEC) on the voltage limitations for any given device our connector could be used in. For most common applications NEC restricts voltage to a maximum of 600V AC or DC which is what our connector voltage ratings are based on.

To achieve UL 1977 approval for a 600V rating, we test our connectors for dielectric withstanding voltage. The connector is tested at 2 times the rated voltage of 600V plus 1000V or 2200VAC for 1 minute. For applications exceeding 600V, UL / NEC / IEC may require application specific review for creepage and clearance resistance.

| FREQUENTLY ASKED QUESTIONS |

Q: Can I cross mate low and high mating force contacts?

A: Yes, however this would not be a connection solution we have tested for safety agency approval. Additionally the contacts may wear at an accelerated rate causing the mating cycle rating to be reduced. The mating and unmating force expected would be somewhere in between the high and low mating force specification.

Q: Can I crimp multiple wires into 1 crimp barrel?

A: Yes, however this would not be a connection solution we have tested for safety agency approval. Particular care should be used that the bundle of wires do not interfere with the movement of the contact in the housing during mating and unmating (see maximum wire O.D. specification). The total circular mils of all conductor strands should be within + or – 5% of the wire size the contact is intended for. Twist the conductor strands together and crimp using our tooling with range taking capabilities such as the 1368 series. To crimp with other Anderson™ recommended tools, contact customer service for the recommended setting or die and locator combination.

Q: Will the crimp tool I have for standard color-coded lugs, Mil Spec contacts, or another connector manufacturer, work for crimping Anderson™ contacts?

A: No. Our contacts generally do not conform to standard crimp barrel dimensions used for lugs, Mil Spec contacts, or other connector manufacturers. The tooling recommended by us must be used to ensure the performance designed by us is achieved. Alternate tooling will void our warranties and can affect safety agency approvals. In some instances Mil Spec tools are approved for crimping contacts with the dies and locators recommended by us. See tooling charts for specific instances, or contact customer service for more information.

Q: Can metric sized wires be used with Anderson™ contacts?

A: Yes. The majority of our crimp tooling recommendations are based on testing and verification we have performed with AWG sized cables. Metric cables of the same or slightly smaller circular mils equivalent to the AWG wire recommended can typically be successfully terminated in our contacts. There is a wire conversion chart at the end of this catalog section that can be used as a reference when converting AWG to mm² sizes. The 1368 series crimp tooling has a range taking capability that produces a reliable crimp with metric equivalents of AWG cables. Please contact customer service for metric tooling recommendations for other Anderson™ crimp tools.

Q: Are Anderson™ connectors suitable for use in applications where the voltage exceeds 600V AC/DC?

A: Possibly. See “Use of Anderson™ Connectors in Applications Exceeding 600V”, contact customer service with further questions.

Q: How do Powerpole® and Multipole connectors stay securely mated without latches?

A: The proven flat wiping technology used in these connectors features a detent or bump in the contact surface along with powerful stainless steel springs that hold the connectors in the mated position. High mating force contacts have a detent that is raised higher than low mating force contacts. The higher the detent, the more force is required to mate and unmate the contacts. In many applications the detent and spring force is enough to securely hold the connectors in the mated position without the need for latches. Latching shells, clips, or other external devices can be used to secure flat wiping connectors in applications where shock, vibration, or cable strain may overcome the inherent force holding the connectors together.

Q: How does Anderson’s genderless connector design work to make a mated pair.

A: Genderless Powerpole® and Multipole housings do not have a male(pin) and female(socket) side. For wire-to-wire applications the exact same housings and contacts are used on both sides of the mated pair. If your application calls for wire-to-PCB or wire-to-busbar connections then different contacts and possibly housings will be required on each half (similar to male and female connectors).

To make a mated pair of Powerpole® or Multipole connectors simply assemble the connectors closely following the assembly instructions. After each connector half is fully assembled take one half and flip it over. The two halves will mate together. Multi-row Powerpole® assemblies will need to be stacked in mirror images of each other to properly mate the correct circuits. This information is detailed at the beginning of the Powerpole® section.

| TOUCH SAFETY & INGRESS PROTECTION (IP) |

UL 1977 Section 10.2:

Typically required for applications where the connector is external to the end device and operating over 30V or 200A, where wet conditions may be present (600V category).

Testing is performed using a probe that mimics a child's finger. All features of the connector are tested for live parts in the unmated state (no pressure applied). A smaller 3 mm probe is then applied in the mated state to test for live parts. Note that some applications may require the connector to not expose live parts to the 3 mm probe in the mating interface.

IEC 60950:

From the standard for Information Technology Equipment Safety, the requirements are harmonized with UL1950. Typically required for commercial and industrial applications where operators may need some degree of protection while accessing or servicing equipment.

Testing is performed using a probe that mimics an adult finger. All features of the connector are tested for live parts in the unmated state with 30 N of force applied to the probe.

IEC 60529:

Standard for Degrees of Protection Provided by Enclosures is harmonized with EN 60529.

Protection degree number is assigned to both solids and liquids in that order. For example: a connector with an IP20 rating is protected against fingers, but has no protection against ingress of liquids. We take a conservative approach in rating our connectors against liquid ingress and consider any meaningful water ingress to have a harmful effect.

Protection Degree	Solids (First Digit)		Liquids (Second Digit)	
	Description	Protected Against	Description	Protected Against
0	Not Protected		Not Protected	
1	> 50 mm	Large body part such as back of hand	Vertically dripping water (no harmful effect)	Duration: 10 minute Water: 1 mm / minute rainfall Pressure: N/A
2	> 12.5 mm	Adult fingers or similarly sized objects	Tilted 15 degrees up dripping water (no harmful effect)	Duration: 10 minute Water: 3 mm / minute rainfall Pressure: N/A
3	> 2.5 mm	Typical screw drivers or large wires	Water spray up to 60 degree angle (no harmful effect)	Duration: 5 minute Water: 0.7 liter / minute Pressure: 80-100 kN/m ²
4	> 1 mm	Small pointy tools and small wires	Water splash from any direction (no harmful effect)	Duration: 5 minute Water: 10 liter / minute Pressure: 80-100 kN/m ²
5	Dust protected	Complete physical protection, no functional interference from dust	Water jet from any direction (no harmful effect)	Duration: 3+ minute Water: 12.5 liter / minute Pressure: 30 kN/m ² @ 3 m distance
6	Dust sealed	Complete physical protection and sealed from dust ingress	Strong water jet from any direction (no harmful effect)	Duration: 3+ minute Water: 100 liter / minute Pressure: 100 kN/m ² @ 3 m distance
7	N/A		No ingress of water in harmful quantity when immersed up to 1 m depth	Duration: 30 minute Water: Immersion Pressure: 1 m depth
8			No ingress of water in harmful quantity when subject to tests in excess of condition 7	Duration: Mfg. specified Water: Immersion Pressure: 1+ m depth. Mfg. specified

| PREVENTIVE MAINTENANCE |

Damaged connectors, contacts and cables may present hazards, resulting in inefficient battery and charger operation. To avoid these problems, conduct the following maintenance checks at least once annually. If you see any of the following problems, take corrective action immediately.

1. Dirty Connectors

When engaged and disengaged, the contact surfaces of Anderson SB® Connectors “over wipe,” thus providing a self cleaning action. To ensure the continued benefit of this feature, clean the contact surfaces and lubricate the connector. Use a “white” lithium grease, which may be obtained from hardware stores and automotive parts suppliers.

2. Melting Connectors

Connector housings overheat and melt for many reasons. To prevent this:

- A. Examine the crimp between cable and contact. Ensure the crimp tooling recommended by us has been used. Improper crimping, corrosion, and broken wires result in unnecessary resistance causing the contact to heat up.
- B. Check contact surfaces for signs of “pitting” caused by dirt or disengaging connectors under load. One badly pitted contact, particularly in a connector attached to a battery charger, can lead to pitting on surfaces of other contacts. If not corrected, this can result in an epidemic of bad connectors throughout a fleet of electric vehicles and in chargers and batteries.
- C. Check to see if batteries are being disconnected while the charger is still on. This causes the contacts to arc at the tips, resulting with progressive pitting and silver removal from tip to crown. If this practice is occurring, discontinue it now to avoid major repairs in the future.

3. Other Conditions

If any of the following conditions exist, the connector housing, contact and/or cable should be replaced immediately.

- A. **Housing:** Cracks, missing pieces, evidence of excessive heat, discoloration. You may consider replacing the existing housing with a Chemical Resistant equivalent for improved durability against UV rays and common solvents and hydrocarbons.
- B. **Contacts:** Pitting, burns, corrosion, excessive wear and cracked crimp barrels, as shown in image “B”.
- C. **Cable:** Exposed copper near housing, cracked cable, peeling or frayed insulation.
- D. **Handles:** Loose attachment and signs of damage as missing or loose hardware and cracked or broken plastic (Handles should be used for connectors that are hard to reach or move.)
- E. **Cable Clamps:** Loose attachments, signs of abraded cable jacket, missing or loose hardware. (Cable clamps should be used to relieve strain on unmounted cable.)



Uncrimped Good Contact

Damaged Contact

B



Damaged Housing

Good Condition

Glossary of Terminology

Amp / Ampere: Measurement increment of electric current. Abbreviated as "I".

Applicator: A semi-automatic termination machine consisting of an upper and lower half that is used to crimp contacts onto wire. Used in conjunction with an electrical/ mechanical press.

AWG: American Wire Gauge. A standard system for designating wire diameters.

Blindmate: To join two connector halves in a normal engaging mode without visual orientation.

Busbar: Three dimensional constructions enabling electrical distribution of current in power electronic modules. Typically constructed of copper, busbars are most frequently used in power dense applications where the busbar offers a cost or space savings over wire.

Color Coding: A system of identification for terminals and related devices.

Contact Resistance: The electrical resistance of metallic surfaces at their interface in the contact area under specified conditions when carrying a specified test current.

Contact Retention: Minimum axial load in either direction which a contact must withstand while remaining firmly fixed in its normal position within a housing.

Crimp Retention: The axial load which a contact can withstand without separation from the wire.

Crimp Termination: A connection in which a metal sleeve is secured to a conductor by mechanically deforming the sleeve with presses or automated crimping machines, eliminating the need for solder. Not suitable for solid (non-stranded wires).

CSA: Canadian Standards Association, a safety standard writing and testing organization.

Cycle Controlled: To determine if repetitive on/off conditions result in degrading the contact system which may lead to failures such as "thermal run away".

Detent: A bump or raised section projecting from the surface of a contact for keeping the contact in position relative to another and released by greater force.

Dielectric Strength (Withstanding Voltage): The highest potential difference (voltage) that an insulation material of given thickness can withstand for a specified time without occurrence of electrical breakdown through its bulk.

Finger Proof: A connector intended for usage external to the end equipment shall have live parts protected against exposure to contact by persons when assembled, installed, and mated as intended, as determined by UL Articulated probe.

Flammability: The measure of a material's ability to support combustion. Often tested per UL94.

Flat Wiping: The sliding action which occurs when contacts are mated. Wiping has the effect of removing small amounts of contamination from the contact surfaces, thus establishing better conductivity.

Genderless: See "Hermaphroditic"

Heat Rise: Temperature rise associated with the electrical load applied to a mated connection.

Hermaphroditic (Genderless) Connector: A connector in which both mating members are exactly alike at their mating face. There are no male or female members, but designs provide correct polarity.

Hot Plug / Hot Swap: Live connector insertion / extractions.

IEC: International Electrotechnical Commission, a standard writing organization.

Insulation Resistance: Ratio of applied voltage to the total current between the two electrodes in contact with a specific insulation.

IP: Ingress Protection, a standard per IEC 60529 for measurement of ingress for solids and liquids into an enclosure.

Locator / Positioner: Device for positioning contacts into crimping dies.

Make-First / Break-Last (Premate): Sequencing of contact(s) so that they engage prior to the main power contacts. Typically used for ground / positive earth / neutral positions as a protective measure against excess currents, short-circuits, and ground faults.

Make-Last / Break-First (Postmate): Sequencing of contact(s) so that they engage after the main power contacts. Typically used for signal or auxiliary power positions to ensure communications are not started or power circuits switched on until the power contacts are fully engaged.

Mating Force: Force required to join two connector halves in a normal engaging mode.

Modular: Refers to similar parts or modules used as building blocks. A modular connector is one in which similar or identical sections can be assembled together to provide the appropriate connector type or size for the application.

Ohms: Measurement increment of resistance.

Operating Temperature Range: Connector temperature rating established by materials used, plastic, finish, and the base metal. Applying an electrical load will result in a temperature rise that is additive to the operating ambient.

PCB: Acronym for Printed Circuit Board.

Polarization: A technique of eliminating symmetry so that parts may only be mated one way.

Pulse (Surge) Current: Highest instantaneous current that will run through a system.

REACH: The European Community Regulation on chemicals and their safe use. It deals with the Registration, Evaluation, Authorization and Restriction of Chemical substances.

Reducing Bushing: Separate tubular sleeve used to downsize the diameter of a crimp barrel to accept a smaller size wire.

Reeled Contacts: Contacts attached to a feeder strip for use in a high volume crimping tool.

Resistance: The opposition to the passage of an electric current through that element. Abbreviated as "R".

RoHS: Restriction of Hazardous Substances Directive. The European directive on the restriction of the use of certain hazardous substances in electrical and electronic equipment.

Sacrificial Tip: An area of a contact system that absorbs electric arcing to limit damage to the actual mating surface of the contacts.

Self-Wiping: The sliding action which occurs when contacts are mated. Wiping has the effect of removing small amounts of contamination from the contact surfaces, establishing better conductivity.

Spring Loaded: A means of providing contact normal force with the use of a mechanical spring.

Storage Battery: A voltaic battery consisting of two or more storage cells. Energy is accumulated by chemical activity in the charging process and released on demand in the form of electric current.

Strain Relief: A means of termination or installation that reduces the transfer of mechanical stress from the conductor.

Termination: Means of joining contacts to a conductor.

Touch Safe: See "Finger Proof"

Turret / Positioner: See "Locator"

TUV: The TÜV Rheinland Group is provider of technical services that certifies products to standards written by other organizations.

UL: Underwriters Laboratory, a safety standard writing and testing organization.

Volts: Measurement increment of electric potential. Abbreviated as "E".

VDE: A German standard writing and testing organization responsible standards and safety specifications covering the areas of electrical engineering, electronics and information technology.

Watt: Measurement increment of electric power. Abbreviated as "W".

Engineering Reference

| CONVERSION CHART FOR AMERICAN WIRE GAUGE TO METRIC SYSTEM |

AWG Size	Metric mm ²	Circ. Mils	Equivalent Circ.Mils	Approximate Wire Diameter in.	Approximate Wire Diameter mm	AWG Size	Metric mm ²	Circ. Mils	Equivalent Circ.Mils	Approximate Wire Diameter in.	Approximate Wire Diameter mm
-	0.5	-	937	0.032	0.81	1/0	-	106mcm*	-	0.373	9.46
20	-	1020	-	0.036	0.91	2/0	-	133mcm*	-	0.419	10.60
-	0.75	-	1480	0.039	0.99	-	70	-	138.1mcm	0.430	10.90
18	-	1620	-	0.046	1.16	3/0	-	168mcm*	-	0.471	12.00
-	1	-	1974	0.051	1.30	-	95	-	187.5mcm	0.504	12.80
16	-	2580	-	0.051	1.29	4/0	-	212mcm*	-	0.528	13.40
-	1.5	-	2960	0.063	1.60	-	120	-	237.8mcm	0.567	14.40
14	-	4110	-	0.073	1.84	-	-	250mcm	-	0.575	14.60
-	2.5	-	4934	0.081	2.06	-	150	300mcm	-	0.630	16.00
12	-	6530	-	0.092	2.32	-	-	350mcm	-	0.681	17.30
-	4	-	7894	0.102	2.59	-	185	-	365.1mcm	0.700	17.80
10	-	10380	-	0.116	2.93	-	-	400mcm	-	0.728	18.50
-	6	-	11840	0.126	3.21	-	240	-	473.6mcm	0.801	20.30
8	-	16510	-	0.146	3.70	-	-	500mcm	-	0.814	20.70
-	10	-	19740	0.162	4.12	-	300	-	592.1mcm	0.891	22.60
6	-	26240	-	0.184	4.66	-	-	600mcm	-	0.893	22.70
-	16	-	31580	0.204	5.18	-	-	700mcm	-	0.964	24.50
4	-	41740	-	0.232	5.88	-	-	750mcm	-	0.999	25.40
-	25	-	49340	0.260	6.60	-	400	-	789.4mcm	1.026	26.10
2	-	66360	-	0.292	7.42	-	-	800mcm	-	1.032	26.20
-	35	-	69070	0.305	7.75	-	500	-	986.8mcm	1.152	29.30
1	-	83690	-	0.332	9.43	-	-	1000mcm	-	1.153	29.30
-	50	-	98680	0.365	9.27	-	625	-	1233.7mcm	1.287	32.70

* Rounded for simplicity

NOTE: The above wire diameters and circular mils are based on an average of the most commonly available wires. The wire manufacturer's specification should be referenced for information specific to the wire being used.

| VOLTS • AMPS • OHMS • WATTS CONVERSION |

E (volts)	I (amps)	R (ohms)	W (watts)
\sqrt{WR}	$\frac{E}{R}$	$\frac{E}{I}$	$E I$
$\frac{W}{I}$	$\sqrt{\frac{W}{R}}$	$\frac{W}{I^2}$	$I^2 R$
IR	$\frac{W}{E}$	$\frac{E^2}{W}$	$\frac{E^2}{R}$

Volts = $\sqrt{\text{Watts} \times \text{Ohms}}$

Amperes = $\frac{\text{Volts}}{\text{Ohms}}$

Ohms = $\frac{\text{Volts}}{\text{Amps}}$

Watts = Volts x Amps

Volts = $\frac{\text{Watts}}{\text{Amps}}$

Amperes = $\sqrt{\frac{\text{Watts}}{\text{Ohms}}}$

Ohms = $\frac{\text{Watts}}{\text{Amps}^2}$

Watts = Amps² x Ohms

Volts = Amps x Ohms

Amperes = $\frac{\text{Watts}}{\text{Volts}}$

Ohms = $\frac{\text{Volts}^2}{\text{Watts}}$

Watts = $\frac{\text{Volts}^2}{\text{Ohms}}$

Wattage Varies Directly as a Ratio of Voltages Squared.

$$W^2 = W^1 \left(\frac{E^2}{E^1} \right) \times^2$$

3 Phase Amperes = $\frac{\text{Total Watts}}{\text{Volts} \times 1.732}$

| STANDARD TO METRIC CONVERSIONS |

Approximate Conversions From: Standard / US Customary To: SI / Metric Units				
Symbol	When You Know	Multiply By	To Find	Symbol
LENGTH				
in	inches	25.4	millimeters	mm
ft	feet	0.305	meters	m
AREA				
in ²	square inches	645.2	square millimeters	mm ²
ft ²	square feet	0.093	square meters	m ²
VOLUME				
fl oz	fluid ounces	29.57	milliliters	mL
gal	gallons	3.785	liters	L
ft ³	cubic feet	0.028	cubic meters	m ³
MASS				
oz	ounces	28.35	grams	g
lb	pounds	0.454	kilograms	kg
TEMPERATURE				
°F	Fahrenheit	$(F-32) \times 5 / 9$ or $(F-32) / 1.8$	Celsius	°C
FORCE and PRESSURE or STRESS				
lbf	poundforce	4.45	newtons	N
lbf/in ²	poundforce per square inch	6.89	kilopascals	kPa

Approximate Conversions From: SI / Metric Units To: Standard / US Customary				
Symbol	When You Know	Multiply By	To Find	Symbol
LENGTH				
mm	millimeters	0.039	inches	in
m	meters	3.28	feet	ft
AREA				
mm ²	millimeters	0.0016	square inches	in ²
m ²	square meters	10.764	square feet	ft ²
VOLUME				
mL	milliliters	0.034	fluid ounces	fl oz
L	liters	0.264	gallons	gal
m ³	cubic meters	35.314	cubic feet	ft ³
MASS				
g	grams	0.035	ounces	oz
kg	kilograms	2.202	pounds	lb
TEMPERATURE				
°C	Celsius	1.8C + 32	Fahrenheit	°F
FORCE and PRESSURE or STRESS				
N	newtons	0.225	poundforce	lbf
kPa	kilopascals	0.145	poundforce per square inch	lbf/in ²

Powerpole® Family

Powerpole® Connectors - PP15 to PP180

SECTION 2
Powerpole® Family

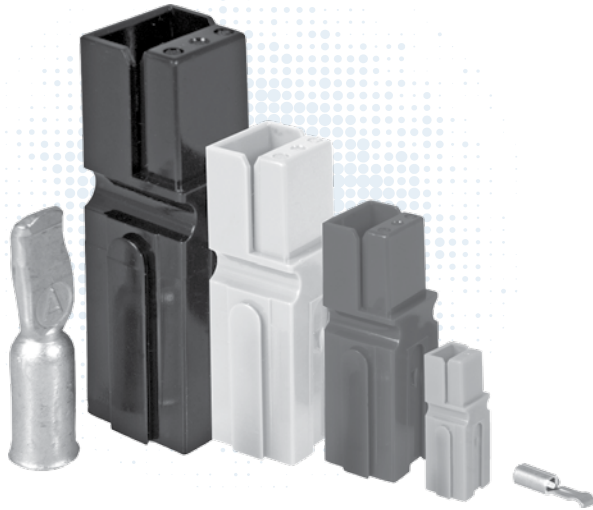

This versatile connector series invented by Anderson Power Products (APP®) meets a wide range of power connection needs. There are four basic housing sizes in the Powerpole® product family that allow specific amperage or wire size needs to be filled in the most compact footprint. Powerpole® can handle up to 350 amperes per pole and accommodate wire ranges of #20 AWG (0.75 mm²) to 3/0 (70 mm²). A wide range of colored housing options can be stacked together to create a proven reliable custom connector. These housings can be used with different contacts to create wire-to-wire, wire-to-board, or wire-to-busbar connections. The Powerpole® connector combines high quality materials and a cost effective innovative design to allow powerful versatility.

Stackable Modular Housings

Available in four sizes to right size your connection need

Color Coded Housings

Help ensure that connectors are assembled and mated correctly

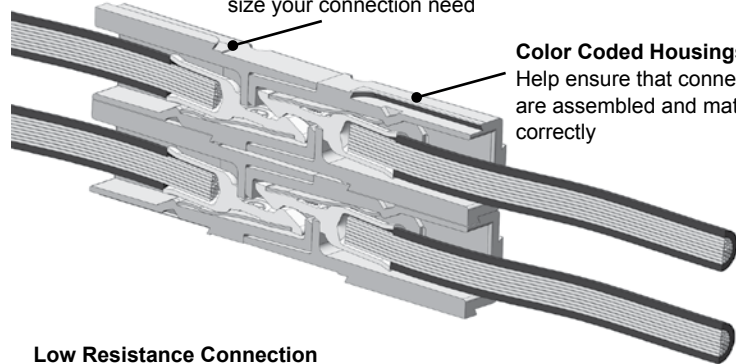

Genderless Housings

Provide simplified assembly and minimize the number of components

Low Resistance Connection

Silver or tin plated contacts inside housings that strongly force the contacts together

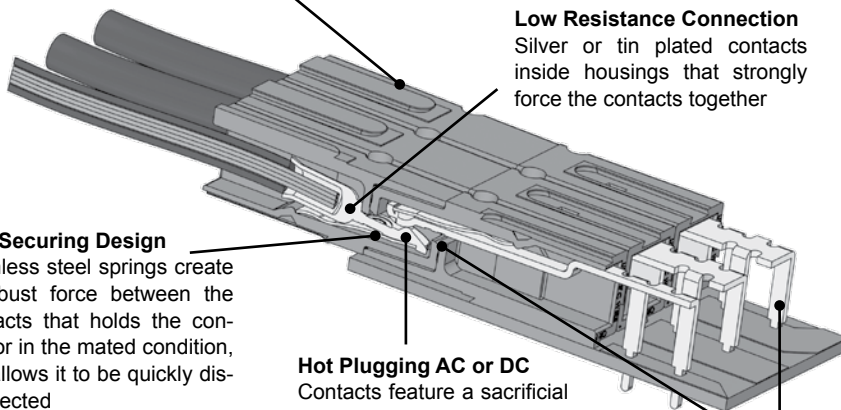

Self Securing Design

Stainless steel springs create a robust force between the contacts that holds the connector in the mated condition, but allows it to be quickly disconnected

Hot Plugging AC or DC

Contacts feature a sacrificial tip that allow high current circuit interrupt

Connection Versatility

Contacts for wire, PCB, or busbar all fit into the same housings

| POWERPOLE® FAMILY SELECTION GUIDE |

Powerpole® Size	PP15 to 45	Page #	PP75	Page #	PP120	Page #	PP180	Page #
Connector Types	Standard	20	Standard	32	Standard	39	Standard	43
	Finger Proof	20	Locking	32			Busbar	44
	PCB	21	Busbar	33				
	Ground	20	PCB	33				
	Power Pak	23						
Amps (UL) Per Pole	0 to 55		120		240		350	
Volts (UL) Per Pole	600		600		600		600	
Wire Gauge (AWG)	20 - 10		16 - 6		6 - 1/0		10 - 3/0	
Wire Gauge (mm²)	0.75 - 6.0		1.3 - 13.3		13.3 - 53.5		5.3 - 85.0	
Number of Power Circuits	1 / Stackable		1 / Stackable		1 / Stackable		1 / Stackable	
Ground	•							
PCB Mount	•		•					
Busbar			•				•	
Panel Mount	•		•		•		•	
Blind Mate	Powerpole® Pak							
Hot Plug	•		•		•		•	
Touch Safe	•							
Polarized Housing	•		•		•		•	
Latching	Powerpole® Pak							
Strain Relief	Powerpole® Pak							

SECTION 2
Powerpole® Family

Actual Size - Connector Half

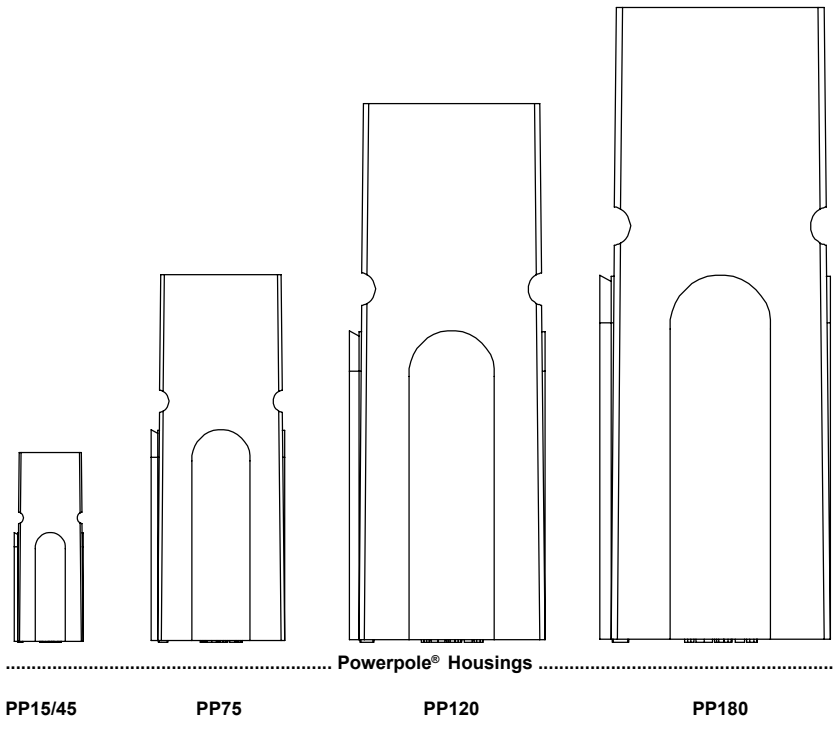

Powerful Versatility

- Create Your Own Custom Connector from Durable Proven Components

Powerpole® connectors can be easily customized to each power connection need. Choose from a wide range of colored housings and stack them together into a multiple position connection. Durable silver or tin plated contacts crimp and poke into housings and are available for a broad range of wire sizes. PCB and busbar contacts can also be simply snapped into place using the same housings. Pre-mate ground / power housings and contacts can be used for safety or sequencing and stack along with standard housings.

How to Create Mating Blocks of Stacked Powerpole® Connectors

A Single Row Assembly such as the 1x3 shown below will mate to itself. If an assembly has more than one row such as the Two Row Assembly 2x1 shown below, then a different mirror image mating assembly is required.

Single Row Assembly 1x3

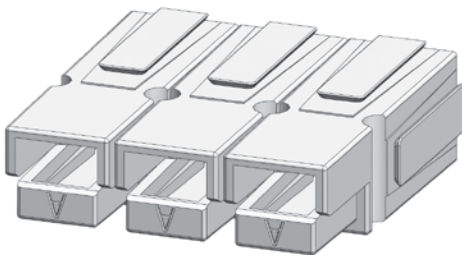

Two Row Assembly 2x1

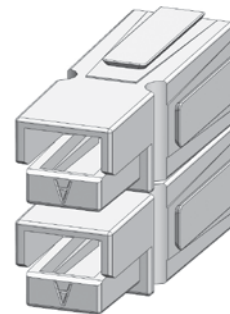

SECTION 2
Powerpole® Family

To Create a Mirror Image Mating Assembly:

When mating blocks are viewed with their hoods in the respective orientation (down or up), the column position of connectors is unchanged. The rows themselves are mirror images of each other. So in the below example, what is column 1 on side A, is column 3 on side B.

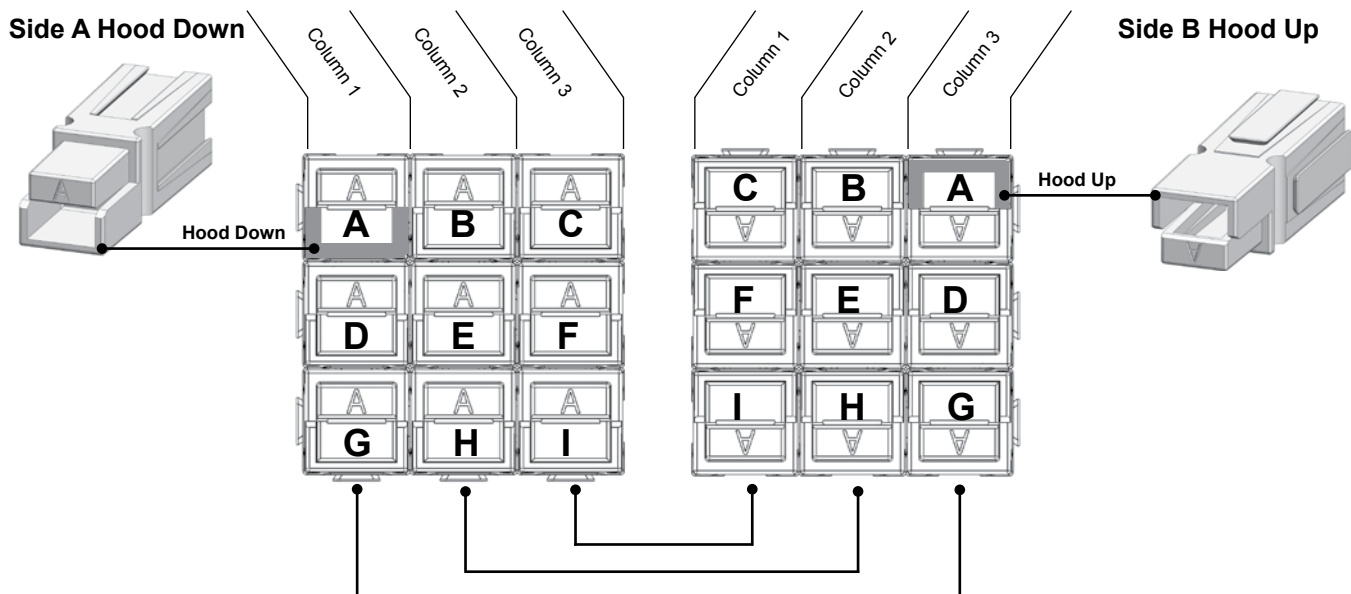

Use the Same Housings for Wire, PCB, or Busbar Connections

The Powerpole® connection system allows the same housings to hold different contacts for terminating to wire, printed circuit boards, or busbars. See some of the many ways Powerpole® components can be assembled to create a custom connection solution.

Wire-to-Wire

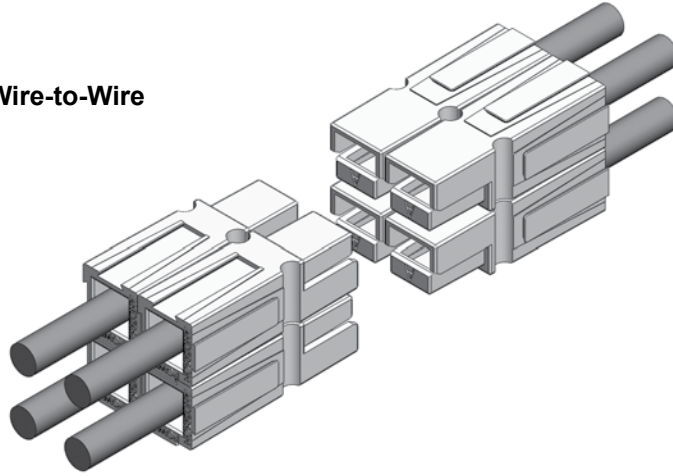

Wire-to-PCB

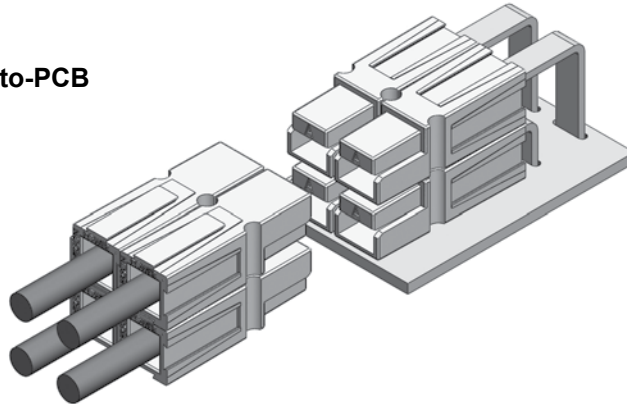

Wire-to-Busbar

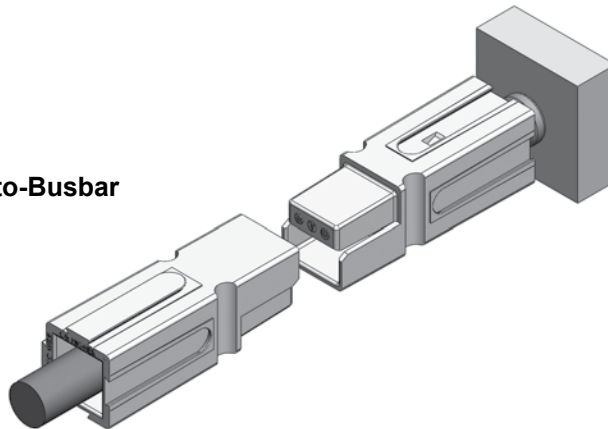

Powerpole® Connectors

- PP15 to PP45 : up to 55 Amps

PP15-45 series are the smallest Powerpole® housings. They can be used for wire-to-wire or wire-to-board applications. Wire sizes from #20 AWG (0.75 mm²) to #10 (6 mm²) offer power capabilities up to 55 amps per pole. Finger proof housings and the ability to incorporate first-mate last-break ground connectors enhance the capabilities of this Powerpole® series.

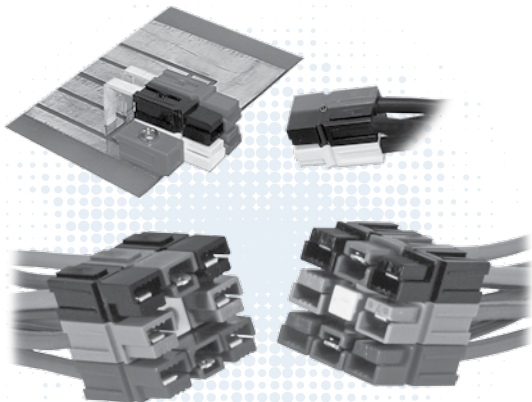

High Power Density

- Up to 55 amps in a compact footprint

Wire-to Wire & Wire-to-Board Configurations

- Wire & PCB contacts can be used in the same housings

Finger Proof Housings Available

- Protects against accidental contact with live circuits

| PP15-45 ORDERING INFORMATION |

PP15-45 Finger Proof Housings

Improved on the original APP design by adding ribs to mating interface to protect against accidental contact with live circuits. Meets the requirements of UL1977 section 10.2 and is rated IP20. Will not mate with standard housings.

Description	Part Numbers	
Minimum Quantity ...	2,500	200
Red	1327FP-BK	1327FP
Green	1327G5FP-BK	1327G5FP
Black	1327G6FP-BK	1327G6FP
White	1327G7FP-BK	1327G7FP
Blue	1327G8FP-BK	1327G8FP
Yellow	1327G16FP-BK	1327G16FP

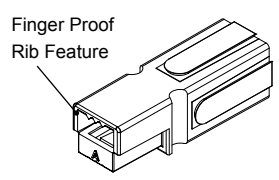

PP15-45 Finger Proof & Standard & Ground Housing Dimensions

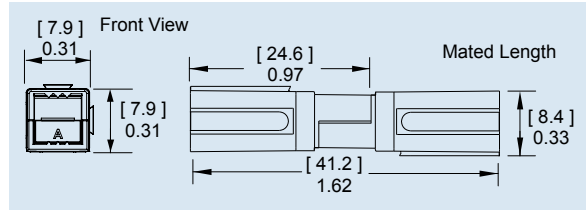

PP15-45 Standard Housings

This original housing design has an open interface and is available in a wide array of colors. Will not mate with finger proof housings.

Description	Part Numbers	
Minimum Quantity ...	2,500	200 ...
Red	1327-BK	1327
Green	1327G5-BK	1327G5
Black	1327G6-BK	1327G6
White	1327G7-BK	1327G7
Blue	1327G8-BK	1327G8
Yellow	1327G16-BK	1327G16
Orange	1327G17-BK	1327G17
Gray	1327G18-BK	1327G18
Brown	1327G21-BK	1327G21
Pink	1327G22-BK	1327G22
Purple	1327G23-BK	1327G23

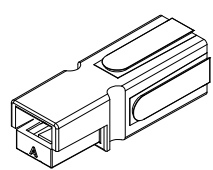

45A Premate Ground Housings - (for use with ground contacts only)

Green housings are keyed to prevent accidental mating with standard or finger proof Powerpole® housings.

Description	Part Numbers	
Minimum Quantity ...	2,500	200 ...
Green	1827G1-BK	1827G1

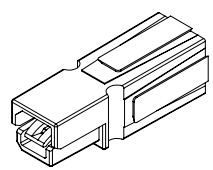

PP15-45 Tin Plated Power Contacts

Offer cost effective performance up to 1,500 mating cycles. See specifications and temperature charts for amperage ratings by wire size.

Barrel	AWG	mm ²	Mating Force	Loose Piece		Reeled		Dimensions - A -	
				Part Numbers		Part Numbers		inches	mm
Minimum Quantity				200	5,000				
Open	14 to 10 K*	2.1 to 5.3	High	269G3-LPBK	269G3	0.21	5.33		
Open	14 to 10 K*	2.1 to 5.3	Low	261G2-LPBK	261G2	0.20	5.08		
Open	14 to 10 SF*	2.1 to 6.0	High	201G1H-LPBK	201G1H	0.24	6.10		
Open	14 to 10 SF*	2.1 to 6.0	Low	200G1L-LPBK	200G1L	0.24	6.10		
Open	16 to 12	1.3 to 3.3	High	269G1-LPBK	269G1	0.18	4.57		
Open	16 to 12	1.3 to 3.3	Low	261G1-LPBK	261G1	0.18	4.57		
Open	20 to 16	0.52 to 1.3	High	269G2-LPBK	269G2	0.16	4.06		
Open	20 to 16	0.52 to 1.3	Low	262G1-LPBK	262G1	0.16	4.06		

K* - For #10 AWG class K stranded wire or smaller. For larger wires use superflex contacts.
SF* - Indicates wires with high stranding such as Super Flex.

Open Barrel Contact

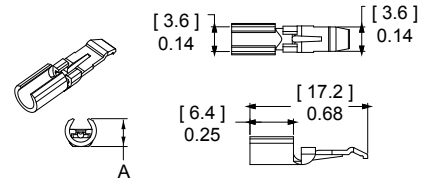

PP15-45 Silver Plated Power Contacts

Maximize performance by offering up to 10,000 mating cycles and are recommended for circuit interrupt or hot plug applications. See specifications and temperature charts for amperage ratings by wire size. Only closed barrel contacts are suitable for soldering.

Barrel	AWG	mm ²	Mating Force	Loose Piece		Reeled		Dimensions - A - - B -				
				Part Numbers		Part Numbers		inches	mm	inches	mm	
Minimum Quantity				5,000	200	5,000						
Open	14 to 10 K*	2.1 to 5.3	Low	-	261G3-LPBK	261G3	0.20	5.08	-	-	-	-
Open	14 to 10 SF*	2.1 to 6.0	Low	-	200G3L-LPBK	200G3L	0.24	6.10	-	-	-	-
Open	20 to 16	0.52 to 1.3	Low	-	262G2-LPBK	262G2	0.16	4.06	-	-	-	-
Closed	16 to 12	1.3 to 3.3	Low	1331-BK	1331	-	0.15	3.81	0.10	2.54	-	-
Closed	20 to 16	0.52 to 1.3	Low	1332-BK	1332	-	0.12	3.05	0.07	1.78	-	-

K* - For #10 AWG class K stranded wire or smaller. For larger wires use superflex contacts.
SF* - Indicates wires with high stranding such as Super Flex.

Open Barrel Contact

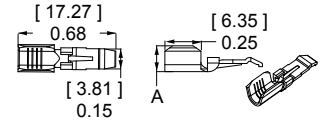

Closed Barrel Contact

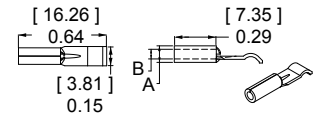

45A Premate Ground Wire Contacts - (for use with ground housing only)

Tin or silver plated contacts are rated for ground or power. Hand tools are available for loose piece contacts. Reeled contacts can be used with high volume press and applicator tooling. Tin contacts are rated for up to 1,500 mating cycles. Silver contacts are rated up to 10,000 mating cycles.

Type	AWG	mm ²	Mating Force	Loose Piece - Part Numbers -	Reeled Part Numbers -
Minimum Quantity				200	5,000
Open, Tin	14 to 10	2.1 to 6.0	Low	1830G1-LPBK	1830G1
Open, Silver	14 to 10	2.1 to 6.0	Low	1830G2-LPBK	1830G2

Open Barrel Premate Contact

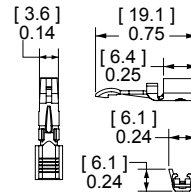

25A Right Angle PCB Contacts Tin Plated

Suitable for right angle applications up to 25A per pole. Tin plating enhances solderability. Cannot be mixed with 45A PCB contacts. For mating with wire contacts only.

Row	Mating Force	Loose Piece		Dimensions - A - - B -			
		Part Numbers		inches	mm	inches	mm
Minimum Quantity		1,000	100				
Top	Low	1377G1-BK	1377G1	0.59	14.80	1.52	38.60
	High	1317G1-BK	1317G1				
Bottom	Low	1377G2-BK	1377G2	0.29	7.20	1.36	34.50
	High	1317G2-BK	1317G2				
Top	Low	1377G11-BK	1377G11	0.59	14.80	1.21	30.70
	High	1317G11-BK	1317G11				
Bottom	Low	1377G12-BK	1377G12	0.29	7.20	1.01	25.70
	High	1317G12-BK	1317G12				

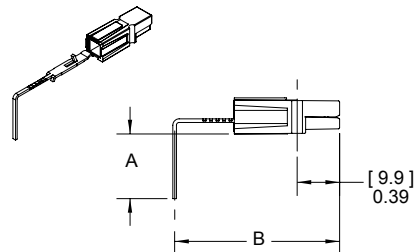

Use mounting staples with right angle contacts (see accessories).
See website for PCB layout drawing.

25A Vertical PCB Contacts Tin Plated

For mating with wire contacts only. Suitable for vertical applications up to 25A per pole, tin plating enhances solderability.

Mating Force	Loose Piece		Dimensions - A -	
	Part Numbers		inches	mm
Minimum Quantity ... 1,000 100				
Low	1377G3-BK	1377G3	2.22	56.40
High	1317G3-BK	1317G3	2.22	56.40
Low	1377G4-BK	1377G4	1.76	44.70
High	1317G4-BK	1317G4	1.76	44.70
Low	1377G13-BK	1377G13	1.17	29.70
High	1317G13-BK	1317G13	1.17	29.70

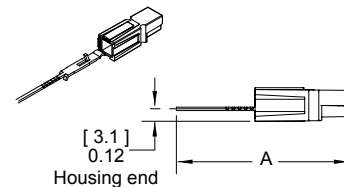

45A Right Angle and Vertical PCB Contacts Tin Plated

Suitable for right angle or vertical applications up to 45A per pole. Tin plating enhances solderability. Right angle contacts cannot be mixed with 25A PCB contacts. For mating with wire contacts only.

Description	Loose Piece	
	----- Part Numbers -----	
Minimum Quantity	1,000	100
Vertical	3-5911P1	1335G1
Right Angle Bottom Row	3-5912P1	1336G1
Right Angle Top Row	3-5913P1	1337G1

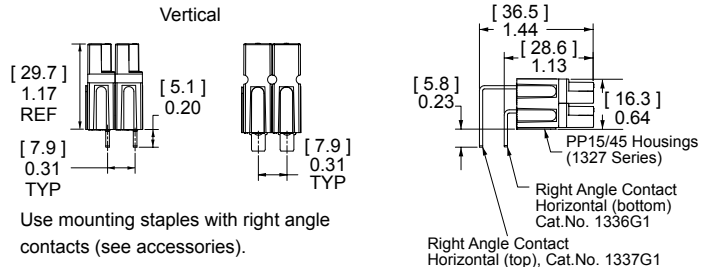

Use mounting staples with right angle contacts (see accessories).

45A Premate Ground PCB Contacts

Right angle contacts are suitable for power or ground. Use to mate with 45A ground wire contacts. Tin plated contacts are rated up to 1,500 mating cycles. Can be used with other 45A PCB connectors in the bottom row.

Description	Mating Force	Loose Piece	
		----- Part Numbers -----	
Minimum Quantity		1000	100
PCB, Bottom Row	Low	3-5952P1	1836G1

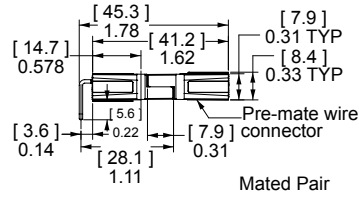

| PP15-45 ULTRASONICALLY BONDED ASSEMBLIES |

Assemblies feature housings that are ultrasonically welded to create a one piece connector unit using an APP special process. After welding, retaining pins are no longer required to secure the stacked housings to each other. This allows Powerpole® 15-45 connectors to be used as a durable one piece connector header. Contact customer service for configurations not shown below.

Single Row 1x2 Assemblies

Circuit Description	Housings Only	Housings with 45A Vertical PCB Contacts	Housings with 45A Right Angle PCB Contacts	Color & Type Position Matrix	
		500	500	1	2
Minimum Quantity	500	500	500	1	2
DC 2 Wire Standard Housings	ASMPP30-1X2-RK	ASMPV45-1X2-RK	ASMPR45-1X2-RK	RED / STD	BLK / STD
DC 2 Wire Reverse Standard Housings	ASMPP30-1X2-KR	ASMPV45-1X2-KR	ASMPR45-1X2-KR	BLK / STD	RED / STD
DC 2 Wire Finger Proof	ASMFP30-1X2-RK	ASMPV45-1X2-RK	ASMPR45-1X2-RK	RED / FP	BLK / FP
DC 2 Wire Finger Proof Reverse	ASMFP30-1X2-KR	ASMPV45-1X2-KR	ASMPR45-1X2-KR	BLK / FP	RED / FP

Single Row 1x3 Assemblies

Circuit Description	Housings Only	Housings with 45A Right Angle PCB Contacts	Color & Type Position Matrix		
		500	1	2	3
Minimum Quantity	500	500	1	2	3
DC 2 Wire Finger Proof with Ground	ASMFP30-1X3-KER	ASMPR45-1X3-KER	BLK / FP	GRN / GND	RED / FP
AC Single Phase Finger Proof	ASMFP30-1X3-KEW	ASMPR45-1X3-KEW	BLK / FP	GRN / GND	WHT / FP

Two Row 2x1 Assemblies

Circuit Description	Housings Only	Housings with 45A Vertical PCB Contacts	Housings with 45A Right Angle PCB Contacts	Color & Type Position Matrix	
		500	500	1	2
Minimum Quantity	500	500	500	1	2
DC 2 Wire Finger Proof	ASMFP30-2X1-KR	ASMPV45-2X1-KR	ASMPR45-2X1-KR	BLK / FP	RED / FP
DC 2 Wire Finger Proof Mate	ASMFP30-2X1-RK	ASMPV45-2X1-RK	ASMPR45-2X1-RK	RED / FP	BLK / FP

Two Row 2x2 Assemblies

Circuit Description	Housings Only	Housings with 45A Vertical PCB Contacts	Housings with 45A Right Angle PCB Contacts	Color & Type Position Matrix			
		500	500	1	2	3	4
Minimum Quantity	500	500	500	1	2	3	4
AC 3 Phase, 3 Wire Finger Proof	ASMFP30-2X2-KRWE	N/A	N/A	BLK / FP	RED / FP	WHT / FP	GRN / GND
AC 3 Phase, 3 Wire Finger Proof Mate	ASMFP30-2X2-WEKR	N/A	ASMPR45-2X2-WEKR	WHT / FP	GRN / GND	BLK / FP	RED / FP

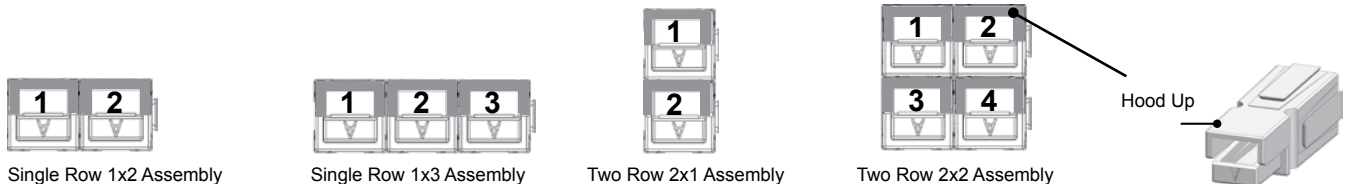

Type

STD = Standard Housing FP = Finger Proof Housing GND = Ground Housing

Powerpole® Pak Connectors - PP15 to PP45

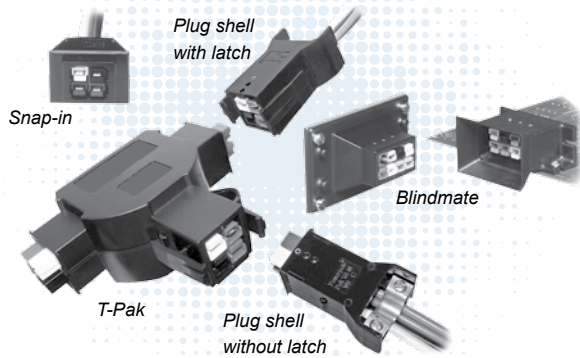

Powerpole® Pak connector shells enclose stacked groupings of PP15-45 sized housings in a durable black shell for a finished connector appearance and additional features. Inline, panel mount, and blindmate configurations are available. Plug shells offer the option of integral latches and strain relief to help secure your connection.

- **Package Groupings of PP15-45 Connectors**
Provides a finished appearance while protecting the individual connectors with an outer shell
- **Inline, Panel Mount, “T” or Blindmate Configurations**
Allows one connection system to meet multiple needs
- **Optional Latching and Strain Relief**
Secures your connection and wires

For environmentally sealed connector shells to hold Powerpole® 15-180 connectors, see SPEC Pak® product series on our website, www.andersonpower.com



POWERPOLE® PAK ORDERING INFORMATION

Powerpole® housings and contacts are sold separately. See page 20 for ordering information.

Plug Shell without Latch

Can mate inline with other plug shells with or without latches, or mate to a panel mount receptacle. For use with Powerpole® wire connectors only. Cable Clamp and Hardware Pak or Retaining Pins must be ordered separately.

Description	Part Numbers			Dimensions - A -	
	1,000	500	25	inches	mm
Minimum Quantity ...	1,000	500	25		
Black, 2-4 Poles	1461G1-BK	-	1461G1	1.24	31.50
Black, 5-6 Poles	-	1461G2-BK	1461G2	1.56	39.62
Black, 7-8 Poles	-	1461G3-BK	1461G3	1.87	47.50

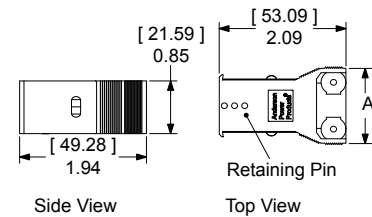

NOTE: Retaining pins are used to secure and position Powerpole® housings in one of three positions in plug shells.
Max wire O.D. for 2-4 pole plug shells is 0.60 inches [15.2mm²].
For all other plug shells is 0.63 inches [16.0 mm²].

Plug Shell with Latch

Can mate inline with other plug shells without latches, or mate to a panel mount receptacle. For use with Powerpole® wire connectors only. Cable Clamp and Hardware Pak or Retaining Pins must be ordered separately.

Description	Part Numbers			Dimensions					
	1,000	500	25	- B -		- C -		- D -	
				inches	mm	inches	mm	inches	mm
Minimum Quantity	1,000	500	25						
Black, 2-4 Poles	1460G1-BK	-	1460G1	1.94	49.28	2.25	57.15	1.24	31.50
Black, 5-6 Poles	-	1460G2-BK	1460G2	1.94	49.28	2.25	57.15	1.56	39.62
Black, 7-8 Poles	-	1460G3-BK	1460G3	1.94	49.28	2.25	57.15	1.87	47.50
Black, 9-10 Poles	-	1460G4-BK	1460G4	2.51	63.75	2.82	71.63	1.84	46.74

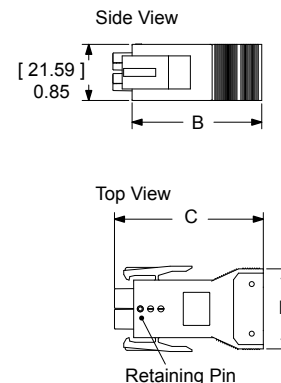

Plug Shell with Latch & Non-Conductive Strain Relief

New 2X3 Powerpole® Pak offers an improved ergonomic shell for easier latch operation as well as a plastic, non-conductive strain relief. The new strain relief can accommodate up to a 6 conductor #10 AWG cable. Can mate to a panel mount receptacle. For use with Powerpole® wire connectors only. Cable Clamp and Hardware Pak or Retaining Pins must be ordered separately. To be used with 115G23 cable clamp only.

Description	----- Part Numbers -----	
Minimum Quantity ..	1,000	25 ...
Black, 5-6 Poles	1460G23-BK	1460G23

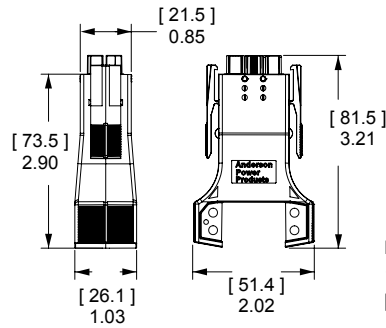

NOTE: Max wire O.D. for 1460G23 is 0.80 inches [20.3 mm²].

Snap-in Receptacle Shell

Mate to plug shells with or without latches, or mate to another panel mount receptacle to create a bulkhead to bulkhead connection. For use with Powerpole® wire or PCB connectors. Order the number of retaining pins for each receptacle as shown below separately.

Description	----- Part Numbers -----			Number of Retaining Pins to Order	Dimensions - E -		Knock Out Size - Width -	
	-----	-----	-----		inches	mm	inches	mm
Minimum Quantity ...	1,000	500	25					
Black, 2-4 Poles	1470G1-BK	-	1470G1	1	1.50	38.10	1.25	31.75
Black, 5-6 Poles	-	1470G2-BK	1470G2	2	1.88	47.75	1.62	41.15
Black, 7-8 Poles	-	1470G3-BK	1470G3	3	2.13	54.10	1.88	47.75
Black, 9-10 Poles	-	1470G4-BK	1470G4	4	2.44	61.98	2.19	55.63

* Height = [25.4 mm] 1.0 in.

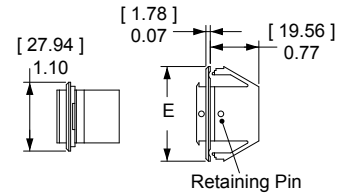

NOTE: Retaining pins are used to secure and position Powerpole® housings in one of two positions in receptacle shells.

Cable Clamp & Hardware Pak

Includes cable clamp, 2 screws, and required amount of retaining pins for each configuration.

Description	Screw Head Type	Cable Type	----- Part Numbers -----		
			-----	-----	-----
Minimum Quantity			1,000	500	25 ...
2-4 Poles	Straight Slot	Bundled	115G1-BK	-	115G1
5-6 Poles	Straight Slot	Bundled	115G2-BK	-	115G2
7-8 Poles	Straight Slot	Bundled	115G3-BK	-	115G3
9-10 Poles	Straight Slot	Bundled	-	115G4-BK	115G4
2-4 Poles	Philips	Bundled	115G7-BK	-	115G7
5-6 Poles	Philips	Bundled	115G8-BK	-	115G8

Cable Clamp & Hardware Pak

Includes 2 cable clamp halves, 2 screws and 2 retaining pins. To be used with 1460G23 Plug Shell only.

Description	Screw Head Type	Cable Type	----- Part Numbers -----	
			-----	-----
Minimum Quantity			1,000	25
5-6 Poles	Philips	Bundled	115G23-BK	115G23

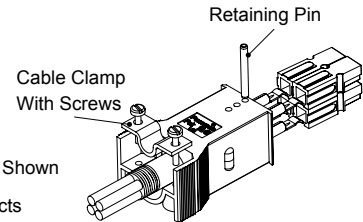
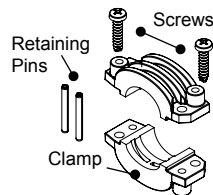

Plug Shell Without Latch Shown
Shell, housing and contacts are sold separately.

Flexible Conduit Clamp & Hardware Pak

Includes cable clamp, 2 screws, and need amount of retaining pins for each configuration.

Description	- Part Number -
Minimum Quantity 100
2-4 Poles	110G10

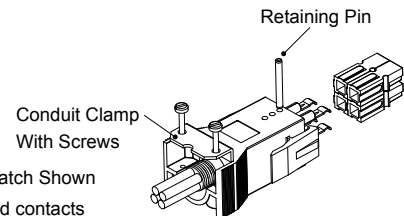

Plug Shell With Latch Shown
Shell, housing and contacts are sold separately.

Retaining Pin for Snap-in Receptacle

Order the number of retaining pins for each receptacle shown in the Snap-in Receptacle Shell ordering information. Pins are also required for the plug side when the Cable Clamp & Hardware Pak is not ordered.

Description	----- Part Number -----
Minimum Quantity 1,000 100 ...
Retaining Pin	110G9-BK 110G9

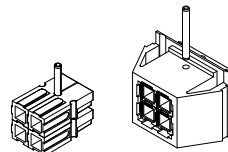

Shell and housing are sold separately.

Blindmate Pak Connector

Ideal for panel to panel, bulkhead to bulkhead, or rack mount applications that require the power connector to compensate for up to 0.45 in. [11.43 mm] of misalignment in either axis. Eight positions can be filled with Powerpole® 10-45 connectors. The receptacle side can be used with wire or PCB contacts. Hardware bag includes retaining pins.

Description	----- Part Numbers -----	
Minimum Quantity	50	25
2x4 Blindmate Plug Shell, Hardware & Pins	-	BMPP10-45P
2x4 Blindmate Receptacle Shell, Hardware & Pins	-	BMPP10-45R
2x4 Blindmate Plug Shell	BMHSG-P	-
2x4 Blindmate Receptacle Shell	BMHSG-R	-
Hardware Bag Plug Side	-	110G50
Hardware Bag Receptacle Side	-	110G51

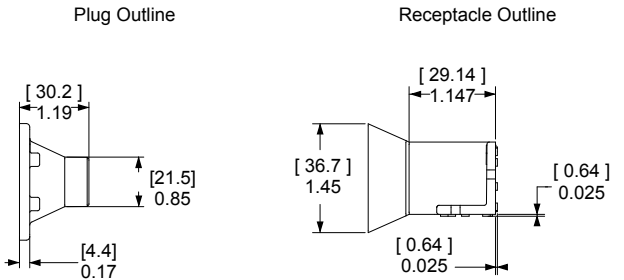
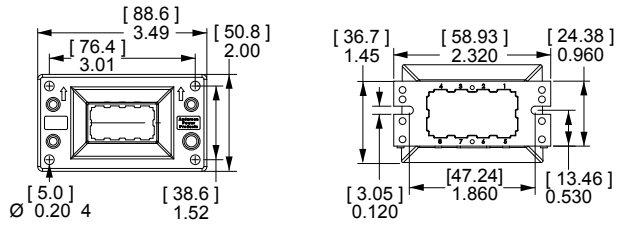

See our innovative MARC Connector that offers straight-on or rotational blindmate capability. MARC holds 6 PP15/45 power contacts and 2 PP15/45 premate ground contacts in a high temperature housing. Visit our website, www.andersonpower.com to learn more.



“T” Pak 2 Way Splitter

The Powerpole® “T” Pak connector is a 2 way electrical splitter that splits electrical current from one incoming circuit into two outgoing circuits. The standard configuration is pre-wired for AC 3 phase, 3 wire plus ground configurations. The “T” Pak can also be used for AC single phase plus ground or DC 2 wire plus ground applications by not using either the red or white power positions. “T” Pak is pre-wired from the factory allowing plug and play field installation of modular office and industrial equipment. UL recognition up to 20 amps and 600 volts is achieved when mating Powerpole® Pak plugs with #12 AWG wire.

For OEM manufacturing scale applications, the “T” Pak can be loaded with custom configurations of any of our finger proof, standard, or ground housings and contacts in the PP15-45 series. Contact sales or customer service for additional information.

Description	- Part Numbers -
Minimum Quantity	80
Assembled “T” Pak	20-01
Mating Plug Shell with Latch 2x2	26-01
Mating Plug Shell without Latch 2x2	27-01

Standard configuration for each side of the T includes (1) each Red, Black, and White Standard PP 15-45 Housings & 261G2-LPBK contacts with (1) 45A Green Premate Ground Housing and 1830G1-LPBK contact.

Mating plug shells include (1) each Red, Black, and White Standard PP 15-45 Housings & (3) 261G2-LPBK contacts with (1) 45A Green Premate Ground Housing and 1830G1-LPBK contact. Cable clamp & hardware pak also included.

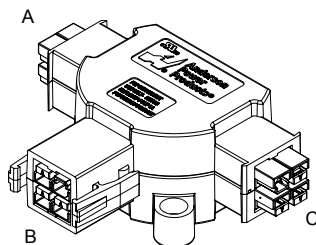
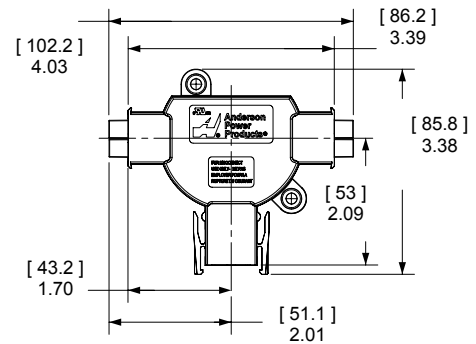

PP15-45 & POWERPOLE® PAK SPECIFICATIONS |

Electrical		
Current Rating Amperes ¹	UL 1977	CSA/TUV
Singlepole Wire to Wire (10 AWG)	55	40
Singlepole Ground Wire to Wire or PCB (10 AWG)	45	35
3x3 Block Wire to Wire (10 AWG)	40	27
Singlepole 25A PCB to Wire (12 AWG)	25	-
2x3 Block 25A PCB to Wire (12 AWG)	25	22 *
Singlepole 45A PCB to Wire (10 AWG)	45	40 *
2x3 Block 45A PCB to Wire (10 AWG)	45	25 *
Voltage Rating AC/DC		
UL 1977	600	
Dielectric Withstanding Voltage		
Volts AC	2,200	
Avg. Mated Contact Resistance Milliohms ¹		
15A Wire Contact with 5/8" of #16 AWG	0.875	
30A Wire Contact with 5/8" of #12 AWG	0.600	
45A Wire Contact with 5/8" of #10 AWG	0.525	
45A PCB Contact to Contact	0.500	
25A PCB Contact to Contact	0.600	
UL Hot Plug Current Rating Amperes ⁵		
250 cycles at 72V DC	45A	
250 cycles at 120V DC	30A	
UL Ground Short Time Current Test - 45A Premate Ground		
750 Amps, #10 AWG Wire	4 Seconds	
470 Amps, #12 AWG Wire	4 Seconds	

Materials	
Housing	
Plastic Resin	Polycarbonate
Contact Retention Spring	Stainless Steel
Housing Flammability Rating	
UL94	V-0
Glow Wire	825°C (GWFI) / 800°C (GWIT)
Contact	
Base	Copper Alloy
Plating	Tin or Silver
Contact Termination Methods	
Crimp ³	Wire Contacts
Hand Solder	1331, 1332 & PCB Contacts
Solder Dip	PCB Contacts
Wave Solder	PCB Contacts

Mechanical		
Wire Size Range	AWG	mm²
	20 to 10	0.75 to 6.0
Max. Wire Insulation Diameter	in.	mm
	0.175	4.450
Operating Temperature ²	°F	°C
Powerpole® Housings & Powerpole® Pak Shells	-4° to 221°	-20° to 105°
Mating Cycles No Load by Plating	Silver (Ag)	Tin (Sn)
PCB to Wire	-	1,500
Wire to Wire	10,000	1,500
Avg. Mating / Unmating Force	Lbf.	N
Low Force Wire, High Force PCB, & Ground	3	13
High Force Wire	5	22
Low Force PCB	2	9
Min. Contact / Spring Retention Force	Lbf.	N
	20	90
Powerpole® Pak Latch Avg. Defeat Force	Lbf.	N
	150	667
PCB Specifications		
Mounting Style	Plated Through Hole	
PCB Thickness- in. [mm]	0.090 - 0.150	(2.3-3.8)
25A PCB Recommended Traces	#12 AWG Cross Section	
45A PCB Recommended Traces	#10 AWG Cross Section	
Mechanical Shock ⁴		
MIL-STD-202	213 Condition A	50g's
Vibration High Frequency ⁴		
MIL-STD-202	204 Condition A	10g's

NOTE 1: See IEC 60664-1 for working voltage.

NOTE 2: Amp ratings are stated per position and based on all positions being fully loaded.

* No TUV Recognition

¹ Based on: 105°C rated or better cable of the largest size, Properly calibrated APP recommended tooling, and a 25°C ambient temperature. UL rating not to exceed the maximum operating temperature. CSA rating below a 30°C temperature rise.

² Limited by the thermal properties of the connector plastic housing.

³ Use APP recommended tooling only. Alternate tools may adversely affect the performance of our connectors along with UL and CSA recognition.

⁴ Tested with contact part number 261G2.

⁵ Based on 2 housings blocked together.

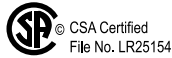

IEC INFORMATION |

Connector Series	Configurations		Creepage / Clearance per IEC 60950-1	Material Group	Connector Series	Configurations		Creepage / Clearance per IEC 60950-1	Material Group
PP15/45 Standard	Single Pole	Unmated	1.64 mm	IIIa	PP15/45 Finger Proof	Single Pole	Unmated	1.64 mm	IIIa
		Mated	1.64 mm				Mated	4.20 mm	
	Stacked Powerpole®	Unmated	1.64 mm			Stacked Powerpole®	Unmated	1.64 mm	
		Mated	1.64 mm				Mated	4.20 mm	
	PCB - 25A	Unmated	1.64 mm			PCB - 25A	Unmated	1.64 mm	
		Mated	1.64 mm				Mated	2.90 mm	
	PCB - 45A	Unmated	1.39 mm			PCB - 45A	Unmated	1.39 mm	
		Mated	1.39 mm				Mated	1.39 mm	

Attributes *	PP45	PP45 FP
AMP Rating AC/DC	45	45 Amp
Voltage Rating AC/DC (Steady State)	160 V AC/DC (Operational)	400 V AC/DC (Operational)
Breaking Capacity -AMP Rating /Cycles	30 Amp / 10 Cycles	30 Amp / 10 Cycles
Voltage Rating (Breaking Capacity)	220 VDC	220 VDC
FINGER Safety - Mated only	IEC 60529 - IP20	IEC 60529 - IP20 *
Wire Size tested	6 mm ²	6 mm ² (10AWG)
Contact Series Tested	200G3L	200G3L
Climatic Testing (Cold,Heat & MFG)	IEC 60512 Test -11j, 11i & 11g,	IEC 60512 Test -11j, 11i & 11g
Cycle Life	IEC 60512 Test 9a - 5000 Cycles	IEC 60512 Test 9a - 5000 Cycles
Mechanical Strength Impact	IEC 60512-5 @ 29.5 Inches - dropped 8 times	IEC 60512-5 @ 29.5 Inches - dropped 8 times
Temperature Range	-20 °C to 105 °C -4 °F to 221 °F	-20 °C to 105 °C -4 °F to 221 °F

* In mated and unmated condition

Protection

Touch Safety with Finger Proof Housings & Wire Contacts or PCB Mating Interface

UL1977 Sec. 10.2	Pass
IEC 60950	Pass
IEC 60529	IP20

Touch Safety With Standard Housings

IEC 60529	IP10
-----------	------



NOTE 3: Refer to the Constructional Data form for additional information on our website., www.andersonpower.com

PP15-45 TEMPERATURE CHARTS | Temperature rise charts are based on a 25°C ambient temperature.

For Temperature Rise Above 60°C, Consult the Extended Temperature Rise Charts in the Appropriate Product Section on the Website.

SECTION 2
Powerpole® PP15 to 45

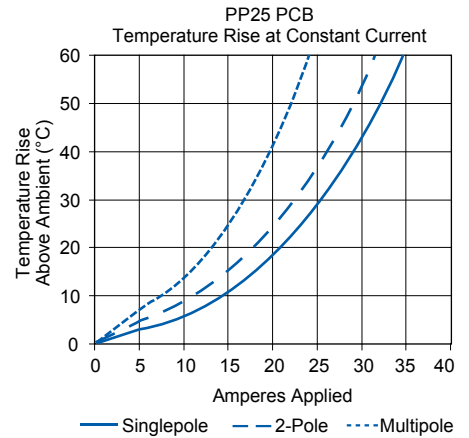
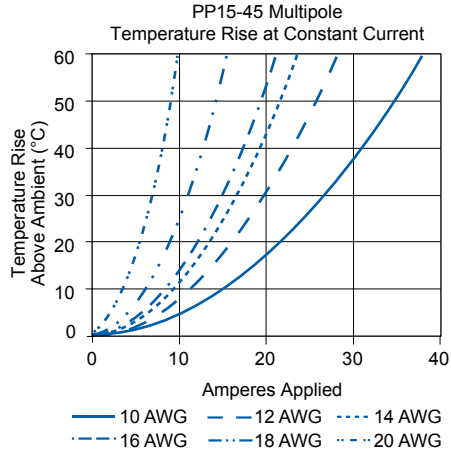
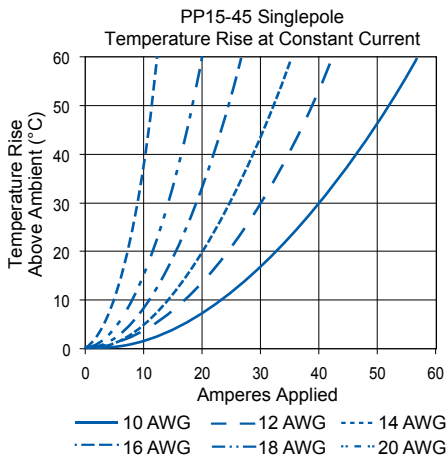

Current - Temperature Derating per IEC 60512-5-2 Test 5B

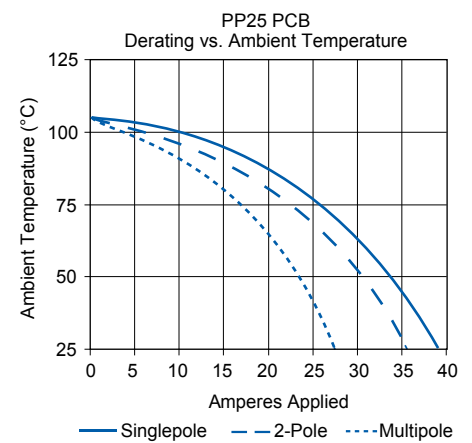
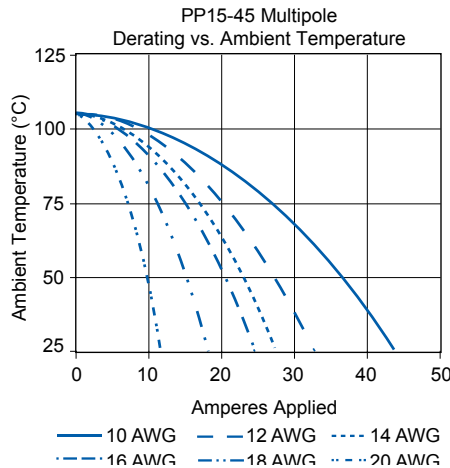
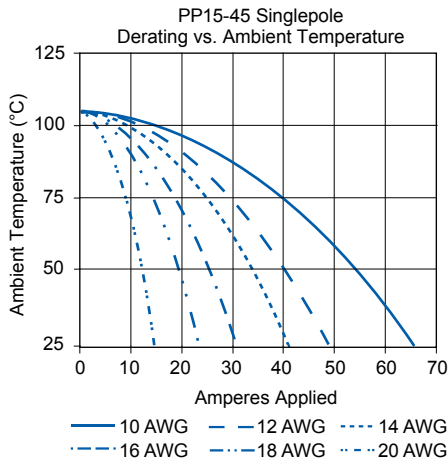

For Temperature Rise Above 60°C, Consult the Extended Temperature Rise Charts in the Appropriate Product Section on the Website.

Current - Temperature Derating per IEC 60512-5-2 Test 5B

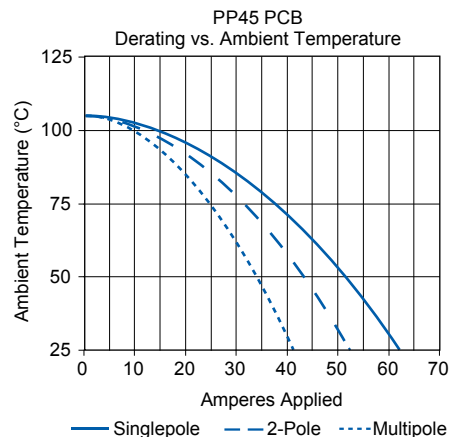
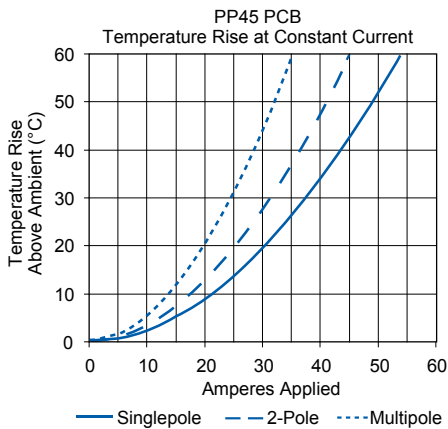

NOTE: PP25 PCB charts based on 0.002 in² foil on board side, mated to #12 AWG conductor on wire side. PP45 PCB charts based on #10 AWG equivalent copper foil on board side, mated to #10 AWG conductor on wire side.

| POWERPOLE® 15-45 ACCESSORIES |

Mounting Wing

Secure dovetailed Powerpole® 15-45 series housings by passing fasteners through the wings in either a horizontal or vertical orientation. Useful for sheet metal panels, printed circuit boards, and many other mounting surfaces. Fasteners not included.

Description	----- Part Numbers -----	
Minimum Quantity ...	2,500	100
Red	1399G9-BK	1399G9
Blue	1399G8-BK	1399G8

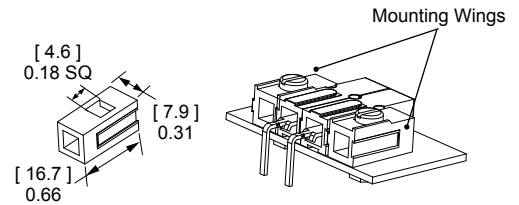

Spacer

Used to separate housings under high power to minimize derating. They are recommended for squaring off a block of Powerpole® 15-45 housings for use in connector shells and mounting clamps. Use a combination of long and short spacers opposite each other in a mated block to add keying features or use two short spacers to avoid interference. Spacers with holes can also be used to fasten the blocked housings to a surface with a fastener.

Description	----- Part Numbers -----	
Minimum Quantity	2,500	100
Red, Short w/ Hole	1399G1-BK	1399G1
Red, Long	1399G2-BK	1399G2
Red, Short	1399G6-BK	1399G6
Black, Long	1399G10-BK	1399G10
Blue, Short	1399G13-BK	1399G13
White, Short w/ Hole	1399G14-BK	1399G14
White, Long	1399G17-BK	1399G17

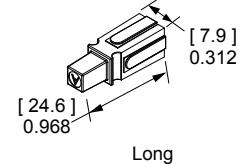
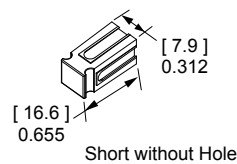
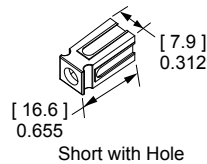

Retaining Pins

Keep stacked Powerpole® 15-45 series housings from separating. Retaining pins are inserted in the circular opening between two housings stacked side by side.

Description	----- Part Numbers -----	Dimensions				
		- A -		- B -		
		inches	mm	inches	mm	
Minimum Quantity ...	1,000	100			
1 Block High	H1507P38	110G16	0.093 / 0.103	2.360 / 2.62	0.250	6.350
2 Block High	111812P5	110G17	0.093 / 0.103	2.360 / 2.62	0.440	11.180

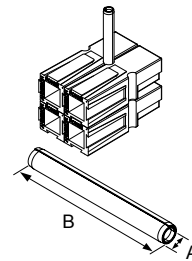

Mounting Clamp

Mounting clamps can be used for fastening a block of Powerpole® 15-45 series housings to a panel. Connector blocks must be a complete square for the clamps to work properly. Fastening hardware not included.

Description	-- Part Numbers --
Minimum Quantity ...	100 sets of 2
2 or 4 Pole	1462G1
3 or 6 Pole	1462G2
4 or 8 Pole	1462G3

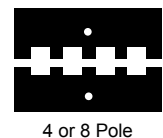
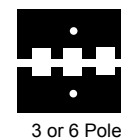
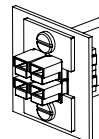

PCB Mounting Staples

PCB staples are soldered into place to secure Powerpole® 15-45 series housings in a horizontal configuration to the board. Reduce strain on soldering joints during mating and unmating.

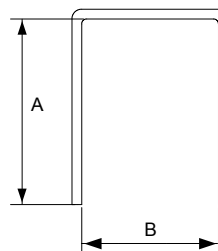

Part Numbers	H x W	Length	Dimensions			
			- A -		- B -	
			inches	mm	inches	mm
Minimum Quantity 100						
114555P1	1 x 1	Short	0.47	12.0	0.28	7.0
114555P2	1 x 2	Short	0.47	12.0	0.57	14.5
114555P3	1 x 3	Short	0.47	12.0	0.89	22.5
114555P7	1 x 4	Short	0.47	12.0	1.20	30.5
114555P10	2 x 1	Short	0.79	20.0	0.28	7.0
114555P6	2 x 2	Short	0.79	20.0	0.57	14.5
114555P9	2 x 2	Long	0.91	23.0	0.57	14.5

Retention Clip

Retention clips prevent Powerpole® 15-45 blocks from unintended disconnects. They feature a tab for easy insertion and removal.

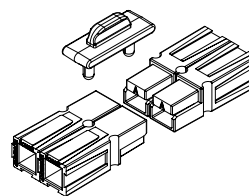

Description	-- Part Number --
Minimum Quantity 100	
1 Block High	110G68

Block Lok

Block locks secure mated Powerpole® 15-45 series housings together. For use in high vibration or shock applications where connectors are unmated infrequently.

Description	- Part Numbers -
Minimum Quantity 100	
2 Pole, Black	110G21
4 Pole, Black	110G12

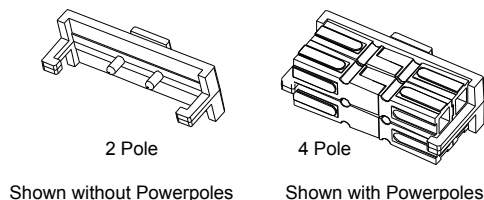

Splash Boot

Splash boots protect a 2x2 block of any combination of Powerpole® 15-45 series housings and feature snip off sealed ends for flexibility in wire O.D. Designed for through panel or inline applications. Not a hermetic seal.

Description	- Part Numbers -
Minimum Quantity 25	
Female, Black	1441G1
Male, Black	1442G1

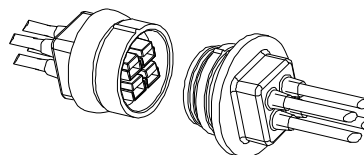

For environmentally sealed connector shells to hold Powerpole® 15-180 connectors, see SPEC Pak® product series on our website, www.andersonpower.com



Powerpole® Connectors

- PP75: up to 120 Amps

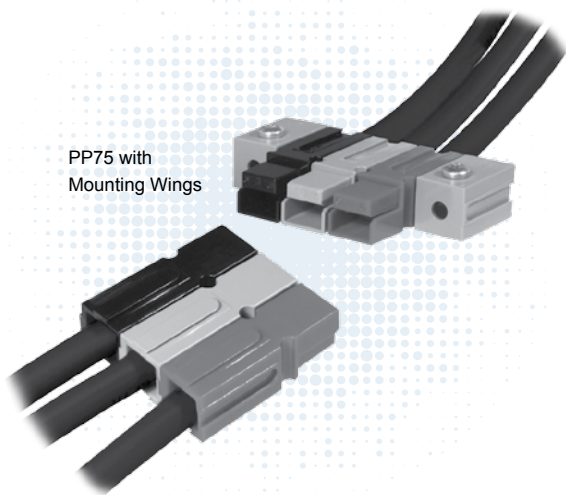

PP75 with
Mounting Wings

PP75 series Powerpole® housings can be used for wire-to-wire, wire-to-board, and wire-to-busbar applications. Wire sizes from #16 AWG (1.3 mm²) to #6 (13.3 mm²) offer power capabilities up to 120 amps per pole. Locking housings offer the capability to secure Powerpole® housings to each other and to mounting pads. Housings made from chemical resistant (CR) resin withstand industrial solvents better than standard housings.

- **Large Wire Range Accommodates up to #6 (10mm²) Wire**
Reducing bushings allow as small as #16 (1.5 mm²) wire to be used
- **Wire, PCB, and Busbar Contacts**
Allows one connection system to meet multiple needs
- **Mini-Powerclaw PCB Contacts Minimize PCB Footprint**
Removes the PP75 housing from the board side

| PP75 ORDERING INFORMATION |

PP75 Standard Housings

The second smallest Powerpole® housing can be used with wire contacts up to 6 AWG [10mm²] as well as PCB and busbar contacts.

Description	----- Part Numbers -----	
Minimum Quantity ...	1,000	100
Red	5916G7-BK	5916G7
Green	5916G6-BK	5916G6
Black	5916G4-BK	5916G4
White	5916G5-BK	5916G5
Blue	5916-BK	5916
Yellow	5916G15-BK	5916G15
Orange	5916G14-BK	5916G14
Gray	5916G16-BK	5916G16

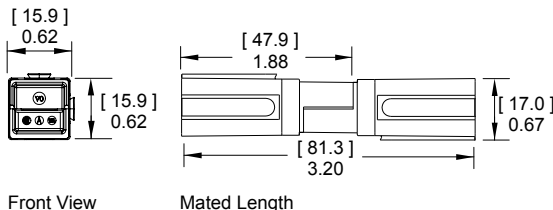

PP75 Chemical Resistant (CR) Housings

Has the same form and dimensions of the standard PP75 housing in a chemical resistant PBT/ PC blend housing. Suitable for use to -40°C.

Description	- Part Numbers -	
Minimum Quantity ...	1,000
Red	P5916G7-BK	
Black	P5916G4-BK	
White	P5916G5-BK	
Blue	P5916-BK	

Material ID V0 = Standard
Located Here P = Chemical Resistant



PP75 Locking Dovetail Housings

Offers dovetails for stacking housings that have a locking feature to prevent housings separating. Can mate to standard and chemical resistant housings, but cannot be stacked with them.

Description	----- Part Numbers -----	
Minimum Quantity	1,000	100
Red	75LOKRED-BK	75LOKRED
Green	75LOKGRN-BK	75LOKGRN
Black	75LOKBLK-BK	75LOKBLK
White	75LOKWHT-BK	75LOKWHT
Blue	75LOKBLU-BK	75LOKBLU
Gray	75LOKGRA-BK	75LOKGRA

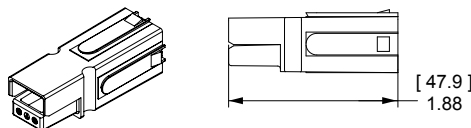

PP75 Premate Ground Housings

Offers a first-mate, last-break connection when stacked together with PP75 housings. Stacks together with PP75 standard and chemical resistant housings. Housings are mechanically keyed to prevent cross mating with power positions.

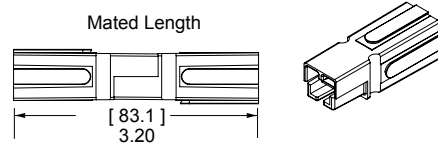

Description	----- Part Numbers -----	
Minimum Quantity...	1,000	100 ...
Green	5927G6-BK	5927G6

PP75 Silver Plated Wire Contacts

Silver plated contacts offer the best electrical performance and durability up to 10,000 mating cycles. See reducing bushings in accessory section for smaller wires.

AWG	mm ²	Mating Force	Loose Piece		Dimensions - A -	
			Part Numbers	Part Numbers	inches	mm
Minimum Quantity			1,000	100		
6	13.3	Low	1307-BK	1307	0.22	5.59
6	13.3	High	5900-BK	5900	0.22	5.59
8	8.4	High	5952-BK	5952	0.19	4.83
12 to 10	3.3 to 5.3	Low	5953-BK	5953	0.14	3.56
12 to 10	3.3 to 5.3	High	5915-BK	5915	0.14	3.56

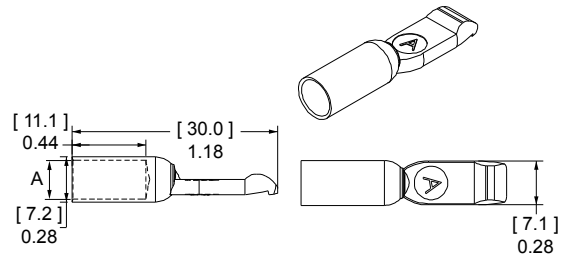

PP75 Premate Ground Wire Contacts

Silver plated contacts for use with the PP75 Premate Ground Housing. Rated to 10,000 mating cycles.

Type	AWG	mm ²	Loose Piece		Dimensions - A -	
			Part Numbers	Part Numbers	inches	mm
Minimum Quantity			1,000	100		
Individual	6	13.3	1875G1-BK	1875G1	0.22	5.59
Individual	8	8.4	1875G2-BK	1875G2	0.19	4.83
Individual	12 to 10	3.3 to 5.3	1875G3-BK	1875G3	0.14	3.56

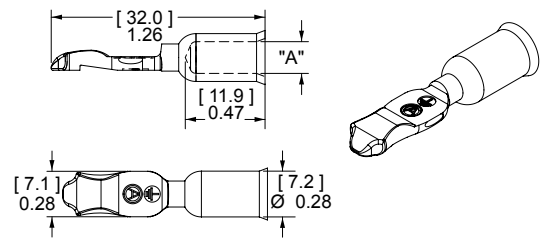

PP75 Silver Plated Busbar Contacts

Provide a quick disconnect input or output busbar connection. Busbar contacts are for mating with wire contacts only. Part number 75BBS includes lock nuts. Locknuts must be ordered separately for B01915P1.

Type	Thread	Mating Force	----- Part Numbers -----		
			Part Numbers	Part Numbers	Part Numbers
Minimum Quantity			1,000	20	10 ...
Busbar	#10-24	High	B01915P1	-	75BBS
Lock Nut	#10-24	-	H1216P8	110G54	-

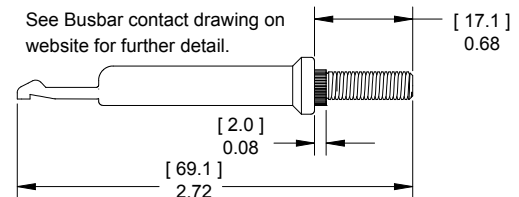

55A Right Angle Standard Powerclaw PCB Contacts

Standard Powerclaw contacts are for use inside a PP75 housing and provide a color coded right angle connection to the PCB.

Description	--- Loose Piece Part Numbers ---	
Minimum Quantity	500	100
Tin Plated	PC5930T-BK	PC5930T
Silver Plated	PC5930S-BK	PC5930S

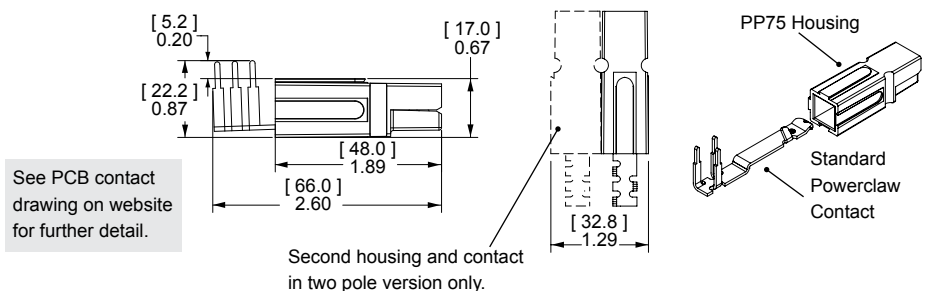

55A Right Angle Mini Powerclaw PCB Contacts

Right angle Mini Powerclaw contacts can be used on the PCB edge without a PP75 housing on the PCB side. A self polarizing design only allow PP75 wire housings to mate to PCB contacts one way.

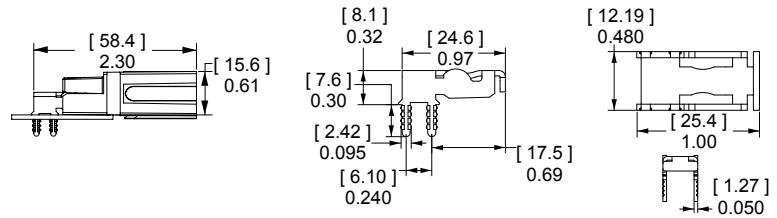

Description	Loose Piece	
	----- Part Numbers -----	
Minimum Quantity ...	1,000	100
Tin Plated	PC5934T-BK	PC5934T
Silver Plated	PC5934S-BK	PC5934S

55A Vertical Mini Powerclaw PCB Contacts

Vertical Mini Powerclaw contacts save space by not requiring a PP75 housing on the PCB side. The guide housing is required for 2 pole applications to provide a polarized connection. (See PP75 accessories).

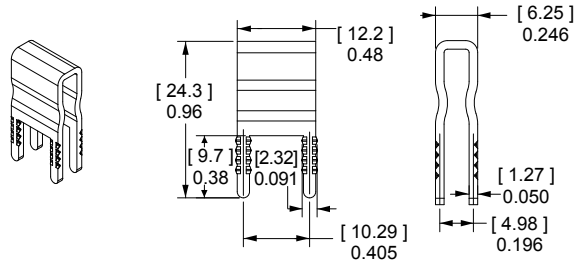

Description	Loose Piece	
	----- Part Numbers -----	
Minimum Quantity ...	1,500	100
Tin Plated	PC5933T-BK	PC5933T
Silver Plated	PC5933S-BK	PC5933S

See PCB contact drawing on website for further detail.

PP75 TEMPERATURE CHARTS

Temperature rise charts are based on a 25°C ambient temperature.

Current - Temperature Derating per IEC 60512-5-2 Test 5B

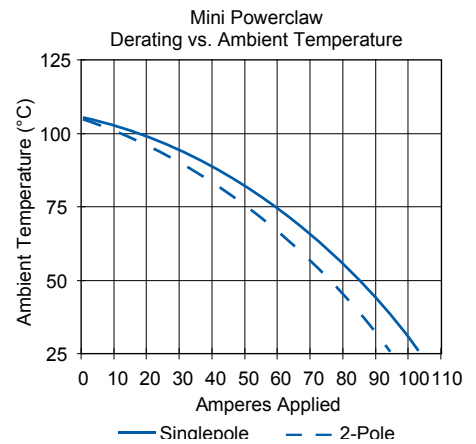
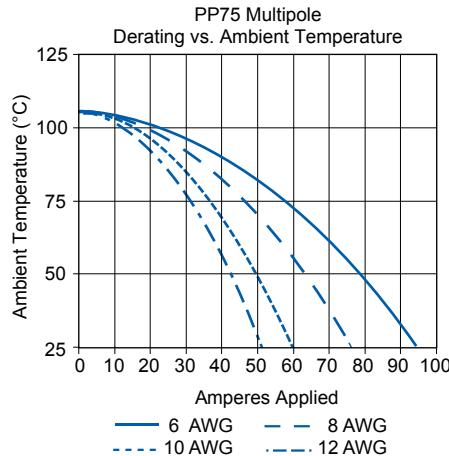
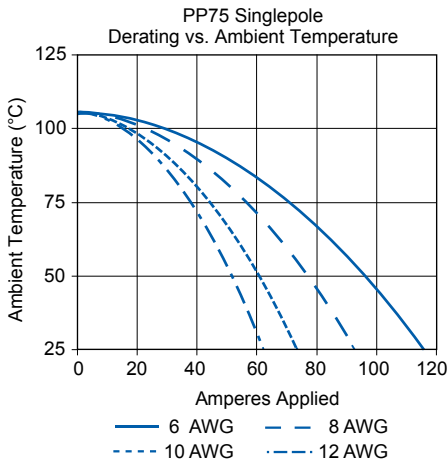

For Temperature Rise Above 60°C, Consult the Extended Temperature Rise Charts in the Appropriate Product Section on the Website.

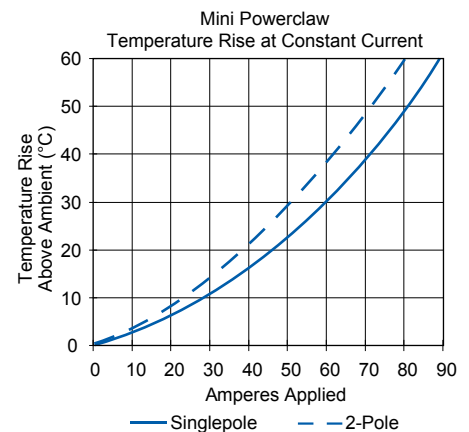
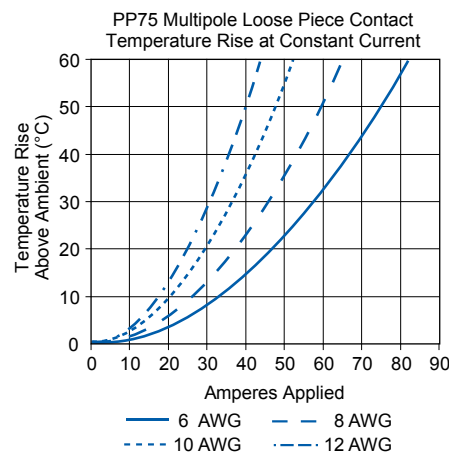
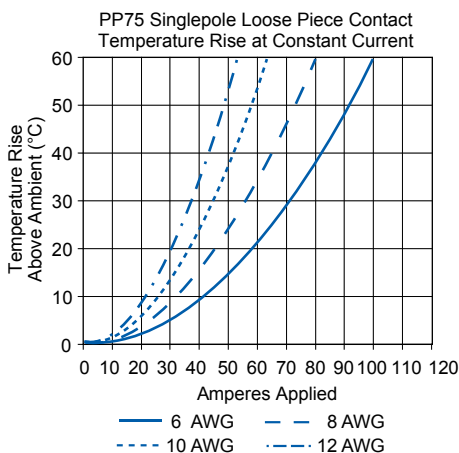

NOTE: Powerclaw charts are based on #8 AWG equivalent copper foil on board side, mated to #6 AWG conductor on wire side.

PP75 SPECIFICATIONS |

Electrical		
Current Rating Amperes ¹	UL 1977	CSA
Wire to Wire (6 AWG)	120	70
Wire to PCB (6-AWG)	55	50
Wire to Busbar (6 AWG)	75	
Voltage Rating AC/DC		
UL 1977	600	
PCB Connector Recommended Voltage ³		
per IEC 60950-1 Table 2L Pollution Degree ²		
Mini Vert. Contact Adjacent Poles	220	
Mini Horiz. Contact Adjacent Poles	200	
Standard Contact Adjacent Poles	635	
Dielectric Withstanding Voltage		
Volts AC	2,200	
Avg. Mated Contact Resistance Milliohms ¹		
Wire Contact with 1 1/4" of #6 AWG	0.200	
PCB Contact to Contact	0.500	
UL Hot Plug Current Rating Amperes - 250 cycles at 120V DC ⁶		
Wire- wire	50A	
PCB- wire (Vertical Mini Powerclaw)	40A	
UL Ground Short Time Current Test - 75A Premate Ground		
1530 Amps, #6 AWG Wire	6 Seconds	

Materials	
Housing	
Standard Plastic Resin	Polycarbonate
Chem. Resistant Resin	Polycarbonate / PBT blend
Contact Retention Spring	Stainless Steel
Housing Flammability Rating	
UL94	V-0
Glow Wire	960°C (GWFI) / 800°C (GWIT)
Contact	
Base	Copper Alloy
Wire Plating	Silver
PCB Plating	Sn or Ag over Ni
Contact Termination Methods	
Crimp ⁴	Wire Contacts
Hand Solder	Wire and PCB Contacts
Solder Dip*	PCB Contacts
Wave Solder*	PCB Contacts
Wrench / Socket	Busbar Contacts

Mechanical		
Wire Size Range	AWG	mm²
Wire Contacts with Bushings	16 to 6	1.3 to 13.3
Max. Wire Insulation Diameter	in.	mm
	0.437	11.100
Operating Temperature ²	°F	°C
Standard & Ground	-4° to 221°	-20° to 105°
Chemical Resistant*	-40 to 221°	-40° to 105°
*Chemical resistant material not available for PCB guide housings		
Mating Cycles No Load by Plating	Silver (Ag)	Tin (Sn)
Wire and PCB Contacts	10,000	1,500
Avg. Mating / Unmating Force	Lbf.	N
Wire to Wire Low Force Contacts	5	22
Wire to Wire High Force Contacts	7	31
Standard Powerclaw to Wire	7	31
Mini Powerclaw to Wire	4	17
PCB Specifications		
Mounting Style	Plated Through Hole	
Max PCB Thickness- in. [mm]	Standard: 0.15 [0.381]	
	Mini: 0.25 [0.635]	
Recommended Traces	#8 AWG Cross Section	
Min. Contact / Spring Retention Force	Lbf.	N
Wire Housing	50	222
Min. Creepage / Clearance Distance PCB in.		mm
Standard Powerclaw Adjacent Poles	0.260	6.6
Mini Vert. Powerclaw Adjacent Poles	0.087	2.2
Mini Horiz. Powerclaw Adjacent Poles	0.079	2.0
Mechanical Shock ⁵		
MIL-STD-202	213 Condition A	50g's
Vibration High Frequency ⁵		
MIL-STD-202	204 Condition A	10g's

NOTE 1: See IEC 60664-1 for working voltage.

NOTE 2: Amp ratings are stated per position and based on all positions being fully loaded.

¹ Based on: 105°C rated or better cable of the largest size, Properly calibrated APP recommended tooling, and a 25°C ambient temperature. UL rating not to exceed the maximum operating temperature. CSA rating below a 30°C temperature rise.

² Limited by the thermal properties of the connector plastic housing.

³ Without use of spacers to increase creepage and clearance distances.

⁴ Use APP recommended tooling only. Alternate tools may adversely affect the performance of our connectors along with UL and CSA recognition.

⁵ Tested with contact part number 5900.

⁶ Based on 2 housings blocked together.



| IEC INFORMATION |

Connector Series	Configurations		Creepage / Clearance per IEC 60950-1	Material Group
PP75	Single Pole	Unmated	2.97 mm	IIIa
		Mated	2.97 mm	
	Stacked Powerpole®	Unmated	2.97 mm	
		Mated	2.97 mm	

Attributes	PP75
AMP Rating AC/DC	75
Voltage Rating AC/DC (Steady State)	250 V AC/DC (Operational)
Breaking Capacity -AMP Rating /Cycles	75 Amp / 10 Cycles
Voltage Rating (Breaking Capacity)	220 VDC
FINGER Safety - Mated only	IEC 60529 - IP20
Wire Size tested	16 mm ²
Contact Series Tested	5900
Climatic Testing (Cold,Heat & MFG)	IEC 60512 Test -11j, 11i & 11g,
Cycle Life	IEC 60512 Test 9a - 5000 Cycles
Mechanical Strength Impact	IEC 60512-5 @ 29.5 Inches - dropped 8 times
Temperature Range	-20 °C to 105 °C -4 °F to 221 °F

Protection
Touch Safety with Wire Contacts
IEC 60529 IP10



NOTE 3: Refer to the Constructional Data form for additional information on our website., www.andersonpower.com

POWERPOLE® PP75 ACCESSORIES |

Strain Relief Grommets

Use for strain relief in the back side of a PP75 housing. Wire gauge given for reference only, use grommet ID and wire OD to determine suitability in the end application.

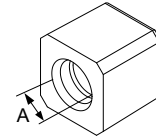

Description	- Part Numbers -	Dimensions	
		- A -	
		inches	mm
Minimum Quantity ...	100	
#6 AWG, Black	114411P2	0.35	8.89
#8 AWG, Black	114411P1	0.25	6.35
#10 - 12 AWG, Black	114411P3	0.17	4.32

Mounting Wing for Standard or CR Housings

Mounting wings can be used to secure dovetailed Powerpole® 75 series housings by passing fasteners through the wings in either a horizontal or vertical orientation. Useful for sheet metal panels, printed circuit boards, and many other mounting surfaces. Fasteners not included.

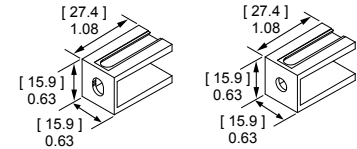

Description	----- Part Numbers -----	
Minimum Quantity ...	1,000	100 ...
Blue, Round Hole	1399G20-BK	1399G20
Blue, Oval Hole	1399G7-BK	1399G7

Mounting Wing for Locking Housings

Mounting wings can be used to secure Powerpole® 75 series housings with locking dovetails by passing fasteners through the wings in either a horizontal or vertical orientation. Useful for sheet metal panels, printed circuit boards, and many other mounting surfaces. Fasteners not included.

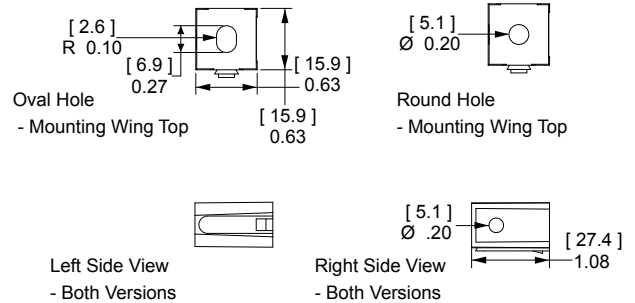

Description	----- Part Numbers -----	
Minimum Quantity ...	1,000	100 ...
Blue, Oval Hole	75LOKWNGBLU-BK	75LOKWNGBLU
Blue, Round Hole	75LOKWNGBLU-R-BK	75LOKWNGBLU-R

Surface Mount for Locking Housings

Use to secure Powerpole® 75 series housings with locking dovetails to a flat surface. Useful for sheet metal panels, printed circuit boards, and many other mounting surfaces. Fasteners not included.

Description	----- Part Numbers -----	
Minimum Quantity ...	1,000	100 ...
Blue	75LOKSMTBLU-BK	75LOKSMTBLU

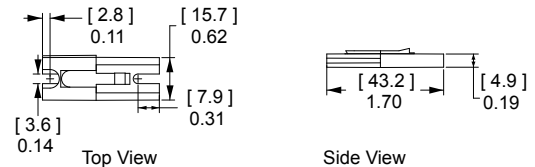

Spacer

Use to separate housings under high power to minimize power capability derating due to heat rise. They are recommended for squaring off a block of Powerpole® 75 housings to enable mounting accessories or retaining pins to be used. Combining long and short spacers opposite each other in a mated block adds keying features, or use two short spacers to avoid interference.

Description	----- Part Numbers -----	
Minimum Quantity...	1000	100
Red, Short	1399G23-BK	1399G23
Red, Long	1399G21-BK	1399G21

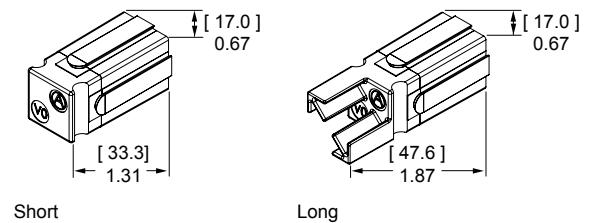

Guide Housings for Vertical Mini Powerclaw Contacts

Prevents polarity being reversed when a two pole PP75 block is mated to vertical mini Powerclaw contacts. Fastening hardware not included.

Description	Part Numbers	
Minimum Quantity ...	1,000	100 ...
Black Guide Housing	PC-HSG-PP-BK	PC-HSG-PP

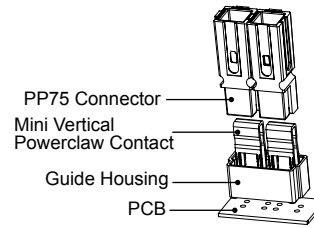

Mounting Clamp

Mounting clamps can be used for fastening a block of Powerpole® 75 series housings to a panel. Connector blocks must be a complete square for the clamps to work properly. Fastening hardware not included.

Description	Part Numbers	
Minimum Quantity ...	50 sets of 2 ...	
2 or 4 Pole	1463G1	
3 or 6 Pole	1463G2	

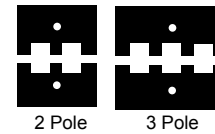
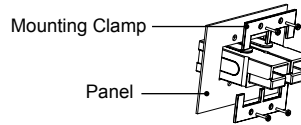

Retaining Pins

Retaining pins are used to keep stacked Powerpole® 75 series housings from separating. Retaining pins are inserted in the circular opening between two housings stacked side by side. Dimension B is +/- 0.015 in or 0.38 mm.

Description	Part Numbers		Dimensions			
			- A -		- B -	
Minimum Quantity ...	1,000	100	inches	mm	inches	mm
1 Block High	111812P7	110G19	0.196 / 0.207	4.98 / 5.26	0.560	14.220
2 Block High	111812P6	110G18	0.196 / 0.207	4.98 / 5.26	1.000	25.400

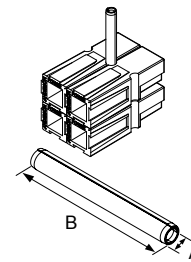

PCB Mounting Staples

Reduce strain on solder joints during mating and unmating. Staples bend over the underside of the PCB board to lock the housings in place. Staples are an interference fit with housings.

Part Numbers	Number of Stacked Powerpoles® H x W
Minimum Quantity	100
PCSTAPLE-2	1 x 2

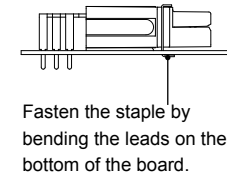
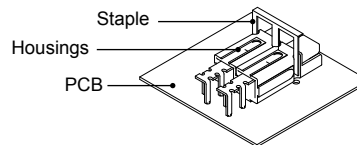

Slide staple over housings and into the holes in the board.

Reducing Bushings

Use with contact part number 5900-BK or 1307-BK to allow a smaller wire to be used with the connector. Electrical capability is derated with smaller wire.

Contact Barrel Size	Wire Size	Part Numbers		Dimensions				
				- ID -		- Length -		
Minimum Quantity		3,000	1,000	100	inches	mm	Inches	mm
#6 AWG [13.3 mm²]	#8 AWG [8.4 mm²]	-	5912-BK	5912	0.18	4.57	0.45	11.43
#6 AWG [13.3 mm²]	#12- 10 AWG [3.3- 5.3 mm²]	5910-BK	-	5910	0.14	3.56	0.47	11.94
#6 AWG [13.3 mm²]	#16- 14 AWG [1.3- 2.1 mm²]	5913-BK	-	5913	0.09	2.29	0.47	11.94

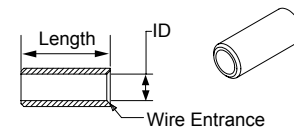

For environmentally sealed connector shells to hold Powerpole® 15-180 connectors, see SPEC Pak® product series on our website, www.andersonpower.com



Powerpole® Connectors

- PP120: up to 240 Amps

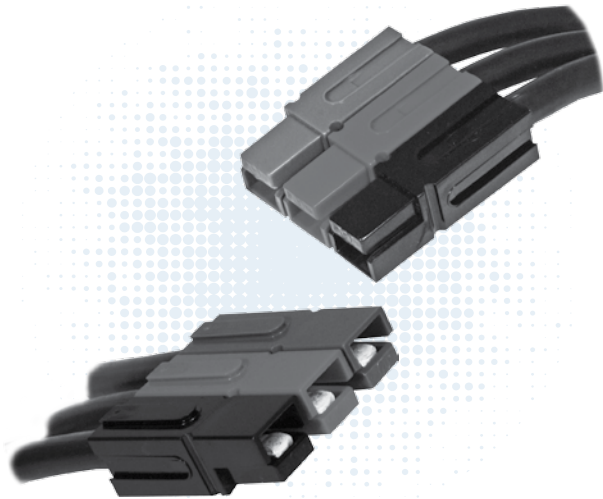

PP120 series Powerpole® housings are designed to accommodate up to 1/0 (50 mm²) wires and handle high currents up to 240 amps. Reducing bushings allow PP120 to accept down to #8 (10 mm²) wires. Multiple colors of stackable housings combine with low resistance flat wiping technology to offer powerful connection capability.

- **Large Wire Range Accommodates up to 1/0 (50mm²) Wire**
Reducing bushings allow as small as #8 (10 mm²) wire to be used
- **Low Resistance Silver Plated Copper Contacts**
Allows currents up to 240 amps
- **UL Rated for Hot Plugging up to 60 Amps**
Great for battery or other applications where the ability to interrupt circuits is required

| PP120 ORDERING INFORMATION |

PP120 Housings

The second to largest Powerpole® housing can be used with wire contacts for up to 1/0 AWG [50mm²] or busbar contacts.

Description	----- Part Numbers -----	
Minimum Quantity ...	500	50
Red	1321G3-BK	1321G3
Green	1321G4-BK	1321G4
Black	1321G1-BK	1321G1
White	1321G2-BK	1321G2
Blue	1321-BK	1321
Gray	1321G8-BK	1321G8

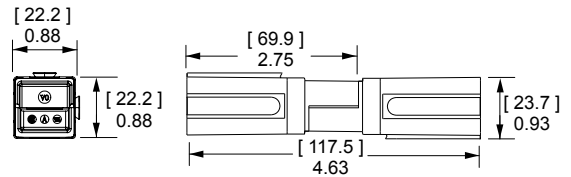

PP120 Silver Plated Wire Contacts

Silver plated contacts offer superior electrical performance and durability up to 10,000 mating cycles. New contacts for #1 to 1/0 AWG (35 to 50 mm²) offer extended capability in the same housings. See reducing bushings in accessory section for smaller wires.

AWG	mm ²	Mating Force	----- Loose Piece Part Numbers -----		- A -		- B -		
			600	500	inches	mm	inches	mm	
1/0	53.5	Low	1323G2-BK	-	1323G2	0.52	13.21	0.44	11.18
1	42.4	Low	1323G1-BK	-	1323G1	0.47	11.94	0.39	9.91
2	33.6	High	-	1319-BK	1319	0.44	11.18	0.34	8.64
4	21.1	High	-	1319G4-BK	1319G4	0.44	11.18	0.29	7.37
6	13.3	High	-	1319G6-BK	1319G6	0.44	11.18	0.22	5.59

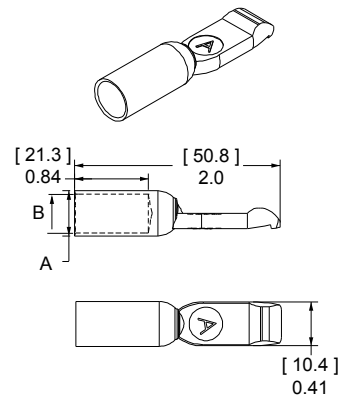

PP120 SPECIFICATIONS

Electrical

Current Rating Amperes ¹	UL 1977	CSA
Singlepole UL 1977 (1/0 AWG)	240	155
2x2 Block UL 1977 (1/0 AWG)	200	110
Voltage Rating AC/DC		
UL 1977	600	
Dielectric Withstanding Voltage		
Volts AC	2,200	
Avg. Mated Contact Resistance Milliohms ¹		
5 1/2" of #2 AWG wire	0.136	
UL Hot Plug Current Rating Amperes ⁴		
250 cycles at 120V DC	60A	

Materials

Housing

Plastic Resin	Polycarbonate
Contact Retention Spring	Stainless Steel

Housing Flammability Rating

UL94	V-0
Glow Wire	960°C (GWFI) / 850°C (GWIT)

Contact

Base	Copper Alloy
Plating	Silver

Contact Termination Methods

Crimp ³	Wire Contacts
Hand Solder	Wire Contacts

Mechanical

Wire Size Range	AWG	mm²
Wire Contacts with Bushings	10 to 1/0	5.3 to 53.5
Max. Wire Insulation Diameter	in.	mm
	0.600	15.240
Operating Temperature ²	°F	°C
	-4° to 221°	-20° to 105°
Mating Cycles No Load by Plating	Silver (Ag)	
Wire Contacts	10,000	
Avg. Mating / Unmating Force	Lbf.	N
	8	36
Min. Contact / Spring Retention Force	Lbf.	N
	60	267

NOTE 1: See IEC 60664-1 for working voltage.

NOTE 2: Amp ratings are stated per position and based on all positions being fully loaded.

¹ Based on: 105°C rated or better cable of the largest size, Properly calibrated APP recommended tooling, and a 25°C ambient temperature. UL rating not to exceed the maximum operating temperature. CSA rating below a 30°C temperature rise.

² Limited by the thermal properties of the connector plastic housing.

³ Use APP recommended tooling only. Alternate tools may adversely affect the performance of our connectors along with UL and CSA recognition.

⁴ Based on 2 housings blocked together.



IEC INFORMATION

Connector Series	Configurations		Creepage / Clearance per IEC 60950-1	Material Group
PP120	Single Pole	Unmated	4.36 mm	IIIa
		Mated	4.36 mm	
	Stacked Powerpole®	Unmated	4.36 mm	
		Mated	4.36 mm	

Attributes

Attributes	PP120
AMP Rating AC/DC	120
Voltage Rating AC/DC (Steady State)	400 V AC/DC (Operational)
Breaking Capacity -AMP Rating /Cycles	120 Amp / 10 Cycles
Voltage Rating (Breaking Capacity)	220 VDC
FINGER Safety - Mated only	IEC 60529 - IP20
Wire Size tested	50 mm ²
Contact Series Tested	1323G2
Climatic Testing (Cold,Heat & MFG)	IEC 60512 Test -11j, 11i & 11g,
Cycle Life	IEC 60512 Test 9a - 5000 Cycles
Mechanical Strength Impact	IEC 60512-5 @ 29.5 Inches - dropped 8 times
Temperature Range	-20 °C to 105 °C -4 °F to 221 °F

Protection

Touch Safety with Wire Contacts
IEC 60529 IP10



NOTE 3: Refer to the Constructional Data form for additional information on our website., www.andersonpower.com

PP120 TEMPERATURE CHARTS | Temperature rise charts are based on a 25°C ambient temperature.

For Temperature Rise Above 60°C, Consult the Extended Temperature Rise Charts in the Appropriate Product Section on the Website.

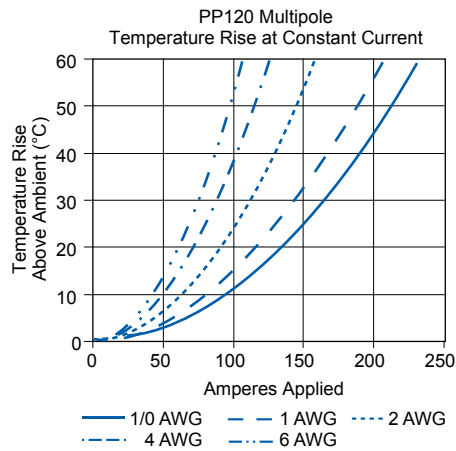
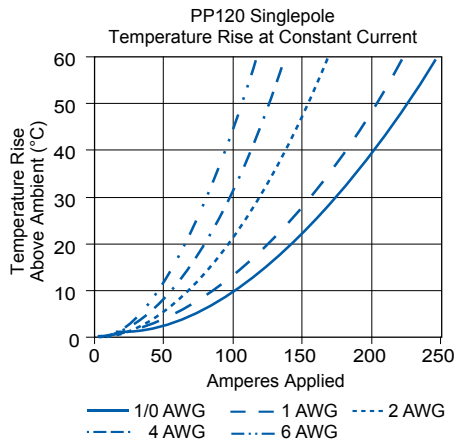

Current - Temperature Derating per IEC 60512-5-2 Test 5B

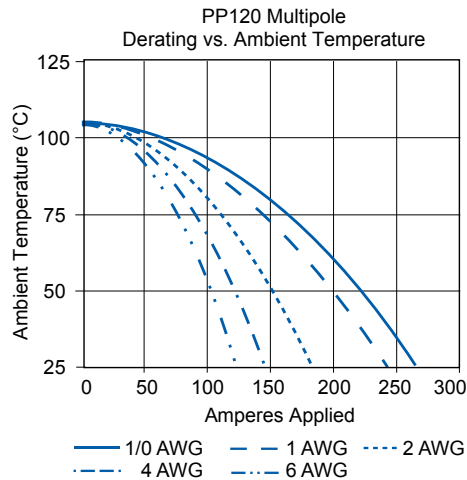
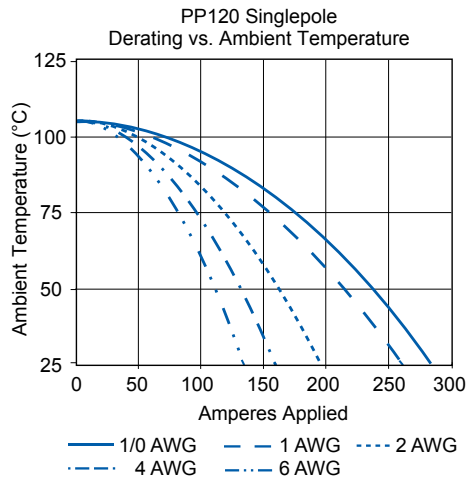

| POWERPOLE® PP120 ACCESSORIES |

Mounting Clamp

Mounting clamps can be used for fastening a block of Powerpole® 120 series housings to a panel. Connector blocks must be a complete square for the clamps to work properly. Fastening hardware not included.

Description	- Part Numbers -
Minimum Quantity ...	20 sets of 2
2 Pole	1464G1
3 Pole	1464G2

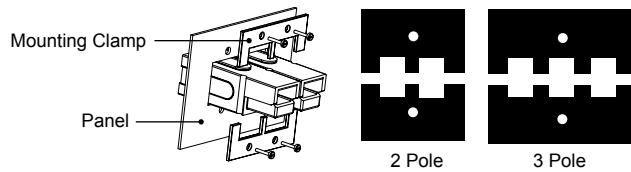

Retaining Pins

Retaining pins are used to keep stacked Powerpole® 120 series housings from separating. Retaining pins are inserted in the circular opening between two housings stacked side by side. Dimension B is +/- 0.015 in or 0.38 mm.

Description	Part Numbers		Dimensions			
			- A -		- B -	
			inches	mm	inches	mm
Minimum Quantity ...	1,000	100				
1 Block High	111812P7	110G19	0.196 / 0.207	4.98 / 5.26	0.560	14.220
2 Block High	111812P8	110G20	0.196 / 0.207	4.98 / 5.26	1.500	38.100

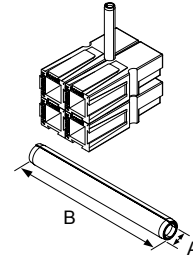

Reducing Bushings

Use with contact part number 1319-BK to allow a smaller wire to be used with the connector. Electrical capability is derated with smaller wire.

Contact Barrel Size	Wire Size	Part Numbers			Dimensions - ID -	
					inches	mm
Minimum Quantity		2,000	1,000	100		
#2 AWG [33.6 mm ²]	#4 AWG [21.2 mm ²]	5919-BK	-	5919	0.28	7.11
#2 AWG [33.6 mm ²]	#6 AWG [16 mm ²]	-	5920-BK	5920	0.23	5.84
#2 AWG [33.6 mm ²]	#10 - 8 AWG [5.3 - 8.4 mm ²]	5921-BK	-	5921	0.18	4.57

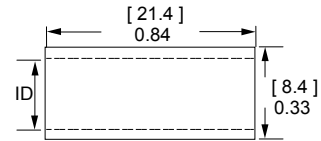

For environmentally sealed connector shells to hold Powerpole® 15-180 connectors, see SPEC Pak® product series on our website, www.andersonpower.com



Powerpole® Connectors

- PP180: up to 350 Amps

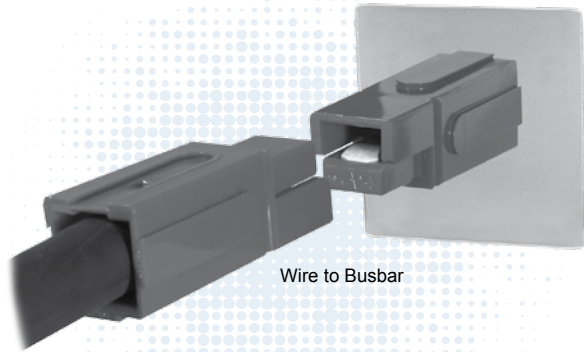

PP180 are the largest of the Powerpole® series housings. They are designed to accommodate up to 3/0 (70 mm²) wires and handle high currents up to 350 amps. Busbar contacts are also available for power inputs and takeoffs. Color-coded housings minimize user confusion and the potential of cross mating circuits.

Low Resistance Silver Plated Copper Contacts

- Allows currents up to 350 amps

UL Rated for Hot Plugging up to 75 Amps

- Great for battery or other applications where the ability to interrupt circuits is required

Busbar Contacts Work with Standard Housings

- Provides a hot swappable quick disconnect system for busbar power distribution

| PP180 ORDERING INFORMATION |

PP180 Housings

The largest Powerpole® housing can be used with wire contacts for up to 3/0 AWG [85mm²] or busbar contacts.

Description	----- Part Numbers -----	
Minimum Quantity ...	250	50
Red	1381G3-BK	1381G3
Green	1381G4-BK	1381G4
Black	1381G1-BK	1381G1
White	1381G2-BK	1381G2
Blue	1381-BK	1381

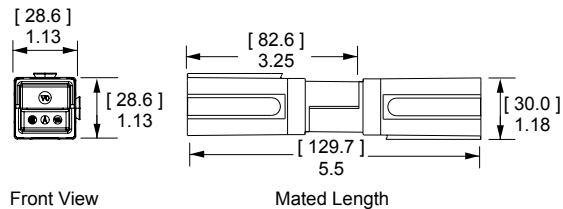

PP180 Silver Plated Wire Contacts

Silver plated contacts offer superior electrical performance and durability up to 10,000 mating cycles. New contacts for 2/0 to 3/0 AWG (70 to 85 mm²) offer extended capability in the same housings. See Reducing bushings in accessory section for smaller wires.

AWG	mm ²	Mating Force	----- Loose Piece Part Numbers -----				Dimensions							
			500	300	250	50	- A -		- B -		- C -		- D -	
Minimum Quantity						inches	mm	inches	mm	inches	mm	inches	mm	
3/0	85	Low	-	-	1328G2-BK	1328G2	2.35	59.69	0.70	17.78	0.58	14.73	1.04	26.42
2/0	67.4	Low	-	1328G1-BK	-	1328G1	2.35	59.69	0.64	16.26	0.49	12.45	1.04	26.42
1/0	53.5	High	1382-BK	-	-	1382	2.35	59.69	0.52	13.21	0.44	11.18	1.04	26.42
1	42.4	High	1347-BK	-	-	1347	2.35	59.69	0.52	13.21	0.39	9.91	1.04	26.42
2	33.6	High	1383-BK	-	-	1383	2.35	59.69	0.52	13.21	0.35	8.89	1.04	26.42
4	21.1	High	1384-BK	-	-	1384	2.35	59.69	0.52	13.21	0.30	7.62	1.04	26.42
6	13.3	High	1348-BK	-	-	1348	2.10	53.34	0.37	9.40	0.22	5.59	0.80	20.32

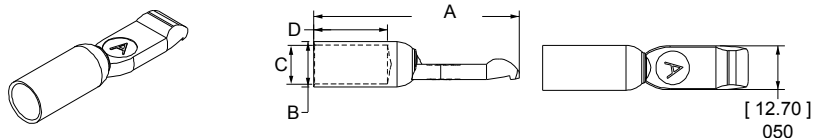

PP180 Silver Plated Busbar Contacts

Use 2 busbar contacts per housing to provide a quick disconnect input or output busbar connection. Busbar contacts are for mating with wire contacts only. Part number 180BBS includes lock nuts. Locknuts must be ordered separately for 180BBS-BK.

Thread	Mating Force	----- Loose Piece Part Numbers -----			
Minimum Quantity		1,000	120	10	
Busbar 1/4-20	High	180BBS-BK	180BBS	-	
Lock Nut 1/4-20	N/A	H1216P7	110G56	110G55	

See Busbar contact drawing on website for further detail.

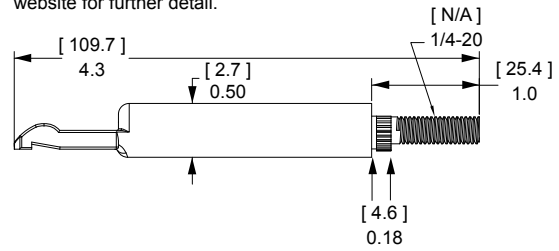

PP180 SPECIFICATIONS

Electrical

Current Rating Amperes ¹	UL 1977	CSA
Singlepole (wire-wire) (3/0 AWG)	350	230
2x2 Block (wire-wire) (3/0 AWG)	350	
Singlepole (wire-busbar) (1/0 AWG)	180	
Voltage Rating AC/DC		
UL 1977	600	
Dielectric Withstanding Voltage		
Volts AC	2,200	
Avg. Mated Contact Resistance Milliohms ¹		
6" of 1/0 AWG wire	0.100	
UL Hot Plug Current Rating Amperes ⁴		
250 cycles at 120V DC	75A	

Mechanical

Wire Size Range	AWG	mm²
Wire Contacts with Bushings	10 to 3/0	5.3 to 85
Max. Wire Insulation Diameter	in.	mm
	0.900	22.860
Operating Temperature ²	°F	°C
	-4° to 221°	-20° to 105°
Mating Cycles No Load by Plating	Silver (Ag)	
Wire and Busbar Contacts	10,000	
Avg. Mating / Unmating Force	Lbf.	N
Wire & Busbar Contacts	10	44
Min. Contact / Spring Retention Force	Lbf.	N
	120	534

Materials

Housing	
Plastic Resin	Polycarbonate
Contact Retention Spring	Stainless Steel
Housing Flammability Rating	
UL94	V-0
Glow Wire	960°C (GWFI) / 850°C (GWIT)
Contact	
Base	Copper Alloy
Plating	Silver
Contact Termination Methods	
Crimp ³	
Hand Solder	
Wrench / Socket*	

*Busbar Contacts Only

NOTE 1: See IEC 60664-1 for working voltage.

NOTE 2: Amp ratings are stated per position and based on all positions being fully loaded.

¹ Based on: 105°C rated or better cable of the largest size, Properly calibrated APP recommended tooling, and a 25°C ambient temperature. UL rating not to exceed the maximum operating temperature. CSA rating below a 30°C temperature rise.

² Limited by the thermal properties of the connector plastic housing.

³ Use APP recommended tooling only. Alternate tools may adversely affect the performance of our connectors along with UL and CSA recognition.

⁴ Based on 2 housings blocked together.



IEC INFORMATION |

Connector Series	Configurations		Creepage / Clearance per IEC 60950-1	Material Group
PP180	Single Pole	Unmated	6.02 mm	IIla
		Mated	6.02 mm	
	Stacked Powerpole®	Unmated	6.02 mm	
		Mated	6.02 mm	

Attributes	PP180
AMP Rating AC/DC	180
Voltage Rating AC/DC (Steady State)	500 V AC/DC (Operational)
Breaking Capacity -AMP Rating /Cycles	180 Amp / 10 Cycles
Voltage Rating (Breaking Capacity)	220 VDC
FINGER Safety - Mated only	IEC 60529 - IP20
Wire Size tested	70 mm ²
Contact Series Tested	1382G2
Climatic Testing (Cold, Heat & MFG)	IEC 60512 Test -11j, 11i & 11g,
Cycle Life	IEC 60512 Test 9a - 5000 Cycles
Mechanical Strength Impact	IEC 60512-5 @ 29.5 Inches - dropped 8 times
Temperature Range	-20 °C to 105 °C -4 °F to 221 °F

Protection	
Touch Safety with Wire Contacts	
IEC 60529	IP10

NOTE 3: Refer to the Constructional Data form for additional information on our website., www.andersonpower.com



PP180 TEMPERATURE CHARTS | Temperature rise charts are based on a 25°C ambient temperature.

For Temperature Rise Above 60°C, Consult the Extended Temperature Rise Charts in the Appropriate Product Section on the Website.

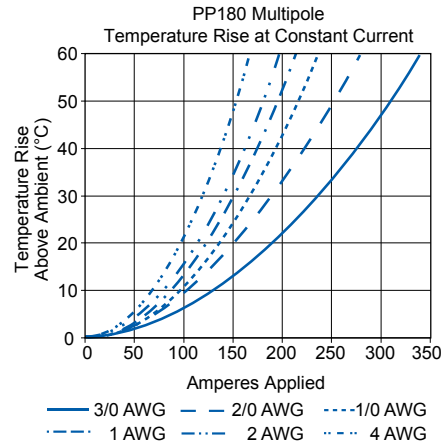
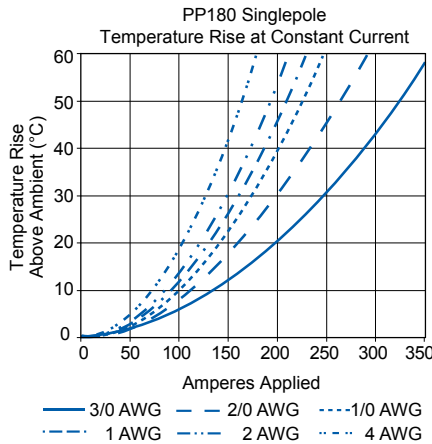

Current - Temperature Derating per IEC 60512-5-2 Test 5B

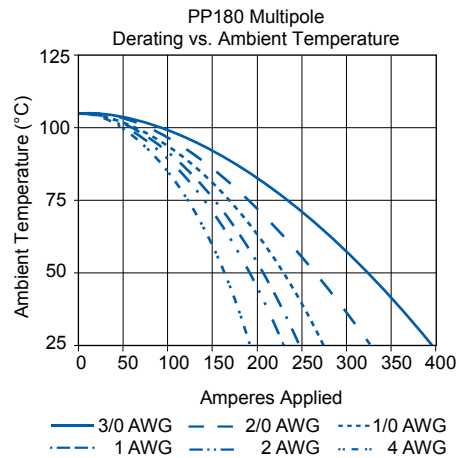
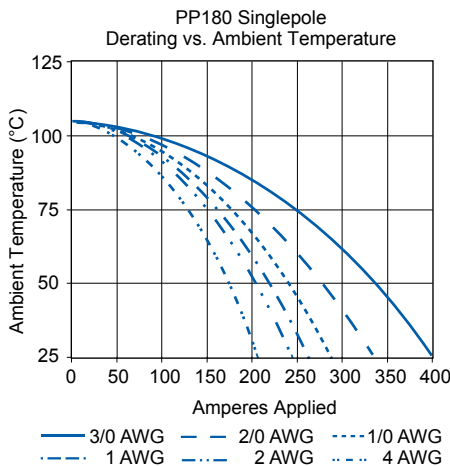

| POWERPOLE® PP180 ACCESSORIES |

Mounting Clamp

Mounting clamps can be used for fastening a block of Powerpole® 180 series housings to a panel. Connector blocks must be a complete square for the clamps to work properly. Fastening hardware not included.

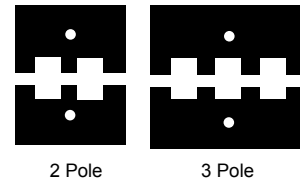
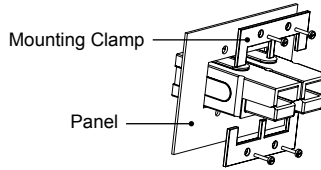

Description	- Part Numbers -
Minimum Quantity ...	20 sets of 2
2 Pole	1465G1
3 Pole	1465G2

Retaining Pins

Retaining pins are used to keep stacked Powerpole® 180 series housings from separating. Retaining pins are inserted in the circular opening between two housings stacked side by side. Dimension "B" is +/- .015 in or .38 mm.

Description	Part Numbers		Dimensions			
			- A - inches		- B - mm	
Minimum Quantity ...	1,000	100				
1 Block High	111812P6	110G18	0.196 / 0.207	4.98 / 5.26	1.000	25.400
2 Block High	111812P8	110G20	0.196 / 0.207	4.98 / 5.26	1.500	38.100

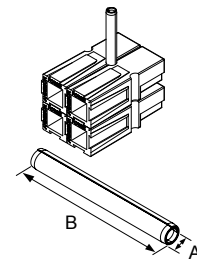

Reducing Bushings

Use with contact part number 1382-BK to allow a smaller wire to be used with the connector. Electrical capability is derated with smaller wire.

Contact Barrel Size	Wire Size	Part Numbers				Dimensions - ID -	
		1,500	1,000	500	100	inches	mm
1/0 AWG [53.5 mm²]	#1 AWG [42.4 mm²]	-	-	5687-BK	5687	0.39	9.91
1/0 AWG [53.5 mm²]	#2 AWG [33.6 mm²]	5690-BK	-	-	5690	0.34	8.64
1/0 AWG [53.5 mm²]	#4 AWG [21.2 mm²]	-	5693-BK	-	5693	0.27	6.86
1/0 AWG [53.5 mm²]	#6 AWG [13.3 mm²]	-	5663-BK	-	5663	0.22	5.59
1/0 AWG [53.5 mm²]	#10 - 8 AWG [5.3 - 8.4 mm²]	5648-BK	-	-	5648	0.19	4.83

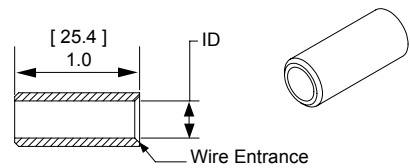

For environmentally sealed connector shells to hold Powerpole® 15-180 connectors, see SPEC Pak® product series on our website, www.andersonpower.com



Powerpole®

- Tooling Information

Wire Size		Reeled Part Numbers		Reeled Contact Crimp Tool	
AWG	mm²	Tin Plating	Silver Plating	APP Applicator +	APP Press
PP15 / 45 Flat Wiping Power & Ground					
#16 / 20	1.3 / 0.52	262G1	262G2	TD0101	115V= TE0101 230V = TE0102
#16 / 20	1.3 / 0.52	269G2	N/A		
#12 / 16	3.3 / 1.3	261G1	N/A		
#10 / 14	5.3 / 2.1	261G2	261G3		
#12 / 16	3.3 / 1.3	269G1	N/A		
#10 / 14	5.3 / 2.1	269G3	N/A		
#10 / 14	5.3 / 2.1	200G1L	200G3L	TD0102	
#10 / 14	5.3 / 2.1	201G1H	N/A		
#10 / 14	5.3 / 2.1	1830G1	1830G2		

* APP applicators are mechanical feed style and do not require an air feed kit.

Wire Size		Loose Piece Part Numbers		Loose Piece Contact Crimp Tool				
AWG	mm²	Tin Plating	Silver Plating	Hand Tool Or	Pneumatic Bench Tool +	Die +	Locator	Number of Crimps
PP15 / 45 Flat Wiping Power & Ground								
#16 / 20	1.3 / 0.52	N/A	1332	1309G2 or 1309G8	N/A	N/A	N/A	Single
#12 / 16	3.3 / 1.3	N/A	1331					
#16 / 20	1.3 / 0.52	262G1-LPBK	262G2-LPBK					
#16 / 20	1.3 / 0.52	269G2-LPBK	N/A	1309G3 or 1309G8	N/A	N/A	N/A	Single
#12 / 16	3.3 / 1.3	261G1-LPBK	N/A					
#10 / 14	5.3 / 2.1	261G2-LPBK	261G3-LPBK					
#12 / 16	3.3 / 1.3	269G1-LPBK	N/A	1309G6 or 1309G8	N/A	N/A	N/A	Single
#10 / 14	5.3 / 2.1	269G3-LPBK	N/A					
#10 / 14	5.3 / 2.1	200G1L-LPBK	200G3L-LPBK					
#10 / 14	5.3 / 2.1	201G1H-LPBK	N/A	1309G6 or 1309G8	N/A	N/A	N/A	Single
310 / 14	5.3 / 2.1	1830G1-LPBK	1830G2-LPBK					
PP75								
#6	13.3	N/A	1307	1309G4	1387G1	1388G6	1389G6	Single
			5900				1389G21	
#8	8.4		1875G1				1389G6	
			5952				1389G21	
			1875G2				1389G6	
#10 / 12	5.3 / 3.3		5953				1389G21	
			5915				1389G6	
			1875G3				1389G21	
PP120								
1/0	53.5	N/A	1323G2	1368 Series	1387G1	1388G3	1389G4	Single
#1	42.4		1323G1					
#2	33.6		1319					
#4	21.2		1319G4					
#6	13.3		1319G6					
PP180								
3/0	85	N/A	1328G2	1368 Series	1387G2	1303G12	1304G32	Double
2/0	53.5		1328G1					
1/0	53.5		1382					
#1	42.4		1347					
#2	33.6		1383					
#4	21.1		1384					
#6	13.3		1348					
						1387G1		

- NOTE: See website for the most current information.
- NOTE: Insertion / Extraction tool for PP15/45 contacts = 111038G2

Multipole Family

Overview of SBS®, SB® & SBX® / SBO® - Main Differentiating Features



SBS®: The “Storage Battery Safety” connector provides a compact connection with a touch safe interface. The newest series of the Multipole connector family continues to add new features and capabilities.

SB®: Based on the original “Storage Battery” connector that pioneered flat wiping contact technology over a half century ago. Two to three positions in a genderless mechanically-keyed housing are suitable for a wide array of power connection applications.

SBX®: The addition of auxiliary positions to the SB® created the “Storage Battery Auxiliary” connector. Up to 8 auxiliary positions allow expanded capabilities for the Multipole family by allowing intelligent power switching, monitoring of battery charge status, and other signal functions to be integrated into a single connector.

SBE®: By modifying the SBX® housing the “Storage Battery European” connector was created. The SBE® housings are molded from a chemical resistant PBT resin and the SBE®320 features improved touch safety over the SBX®350 design.

SBO®: Designed to meet the needs of connecting office equipment, the “Storage Battery Office” connector is molded out of durable PC like the original SB® but incorporates the auxiliary positions of the SBX® in a housing similar to the SBE®80.

SB® Smart: Designed for applications where storage batteries intelligently interact with the system. Two primary power positions are combined with sixteen auxiliary power / signal positions. This allows one connection to be used to route high power lines, low power lines, and signal circuits.

SECTION 3
Multipole Family

Hot Plugging AC or DC

Contacts feature a sacrificial tip that allow high current circuit interrupt

Genderless Housings

Provide simplified assembly and minimize the number of components

Low Resistance Connection

Silver or tin plated contacts inside housings that strongly force the contacts together

Self Securing Design

Stainless steel springs create a robust force between the contacts that holds the connector in the mated condition

Keyed & Color Coded Housings

Prevents accidental cross mating of circuits

Compact Power to Size Ratio

Maximizes valuable PCB edge real estate with a compact high power design

Auxiliary or Ground Positions

For signal transmission or the added safety of a premate ground

| MULTIPOLE FAMILY SELECTION GUIDE |

	SBS® Mini	SBS®	SB®	SBX® / SBE® / SBO®	SB® Smart
Page Number	53	57	67	87	105
Amps Per Pole	52	50 - 110	50 - 500	60 - 350	230
Volts (UL) Per Pole	600	600	600	600	600
Wire Gauge (AWG)	10 - 20	16 - 6	16 - 350	6 - 300	10 to 1/0
Wire Gauge (mm²)	4 - 0.75	1.3 - 13.3	1.3 - 150	24 - 152	5.3 to 53.5
Number of Power Circuits	2	2 - 3	2 - 3	2	2
Number of Auxiliary Circuits	0	4	0	8	16
PCB Mount		•	•		•
Bus Bar			•		•
Panel Mount		•	•		
Hot Plug	•	•	•	•	•
Touch Safe	•	•		•	
Mechanically Keyed	•	•	•	•	•
Handle		•	•	•	
Air Supply System				•	
Environmental Protection			•		

Actual Size - Connector Half

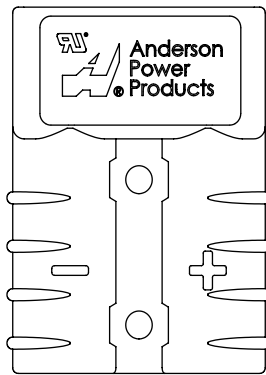

SB®50

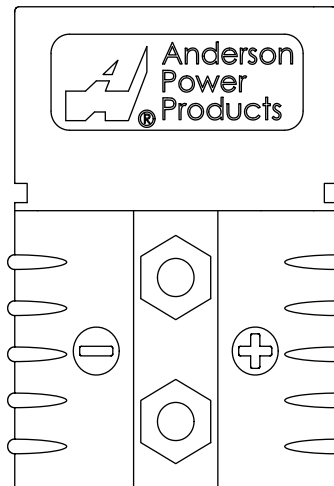

SB®120

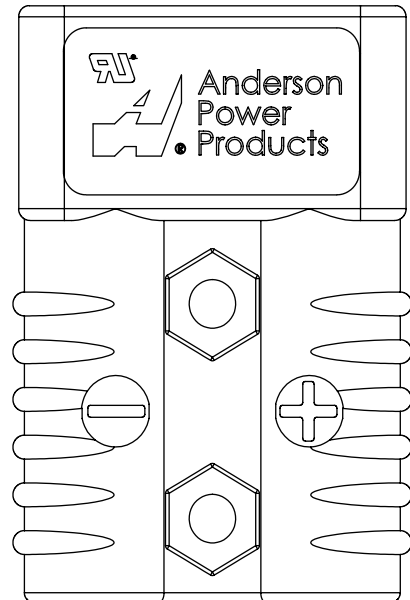

SB®175 - 2 Pole

Protect your SB® 50, 120 & 175 connectors from water, dirt, chemicals and UV light with the SB® Environmental Boot. It protects the SB® connectors in both the mated and unmated condition. More information in the SB® accessory section.



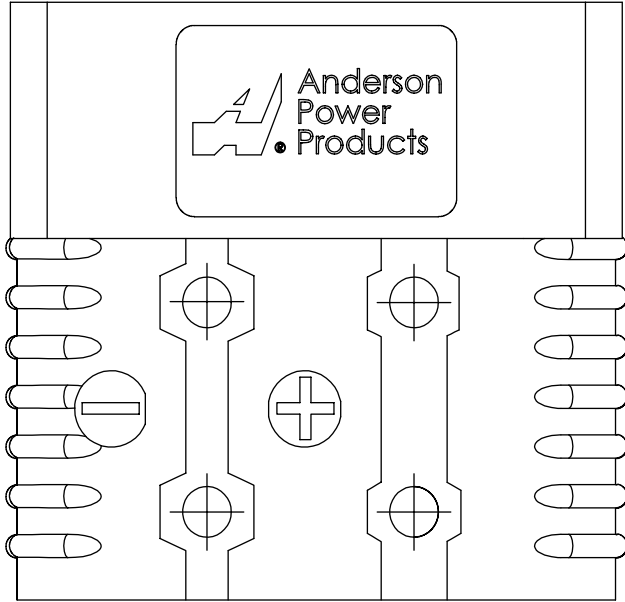

SB®175 - 3 Pole

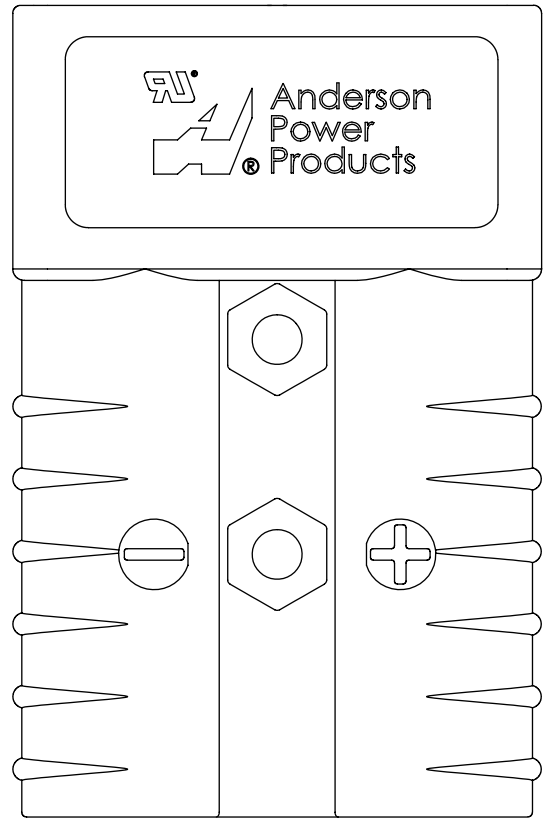

SB®350

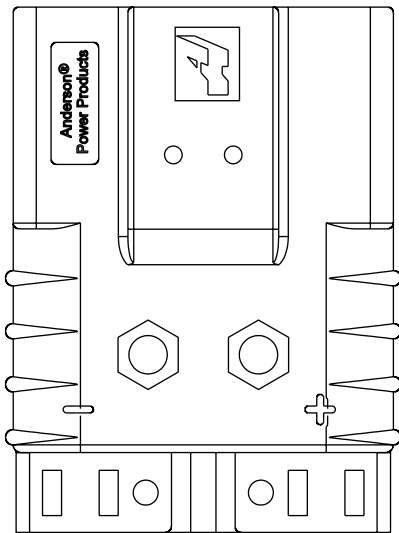

SBE®60 - SBO®80

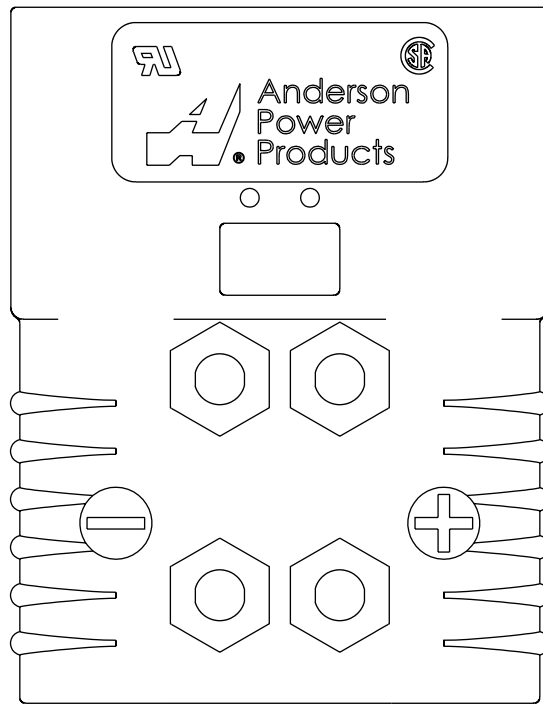

SBE®160 - SBX®175

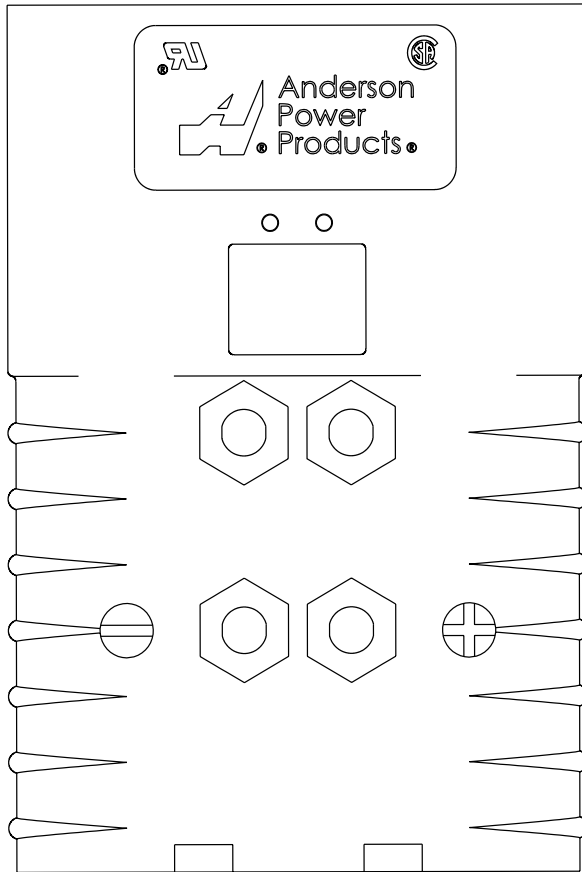

SBE®320 - SBX®350

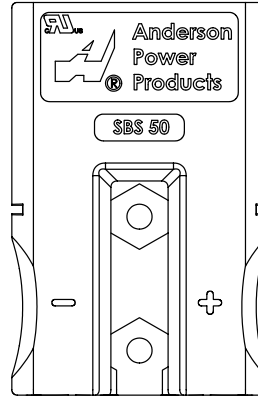

SBS®50



SBS® Mini

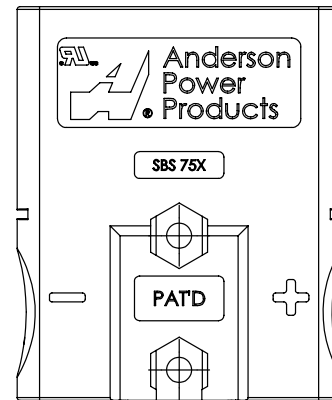

SBS®75X & SBS®75G

Explanation of Mechanical Voltage Keys

Features molded into the mating interface of the connector housing prevent accidental cross mating of circuits. This molded feature mechanically keys the connection so that only housings with the same mating interface can be mated together.

Different mechanical keys can be easily recognized by the color of the housing. This color coding corresponds to a voltage that industrial trucks, batteries, and chargers have adopted as a standard to prevent incompatible voltages from cross mating.

The same mechanical keying and color coding that is so successful for industrial trucks, is also widely used in power electronics applications. UPS systems, power supplies, personal mobility, and alternative energy applications have all used this feature to ensure user safety.

Note: Some housings in the SB®50, SB®175, and SB®350 series have different colored housings with a shared mechanical keying feature. Please see the specific data sheet for details.

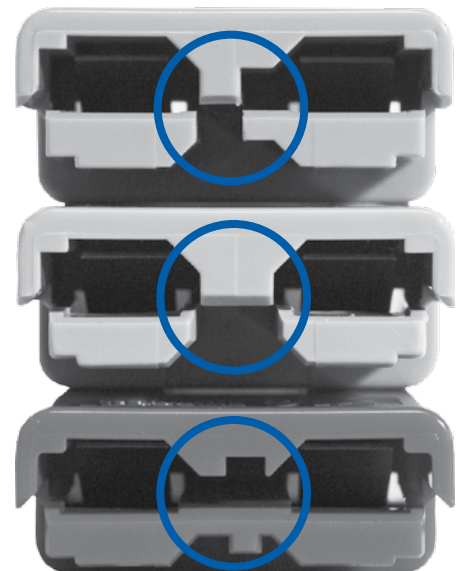

Recommended Voltage Key Color Code

Voltage	12V	18V	24V	36V	48V	72V	80V	96V	120V	144V
Color	Yellow	Orange	Red	Gray	Blue	Green	Black	Brown	Purple	White

SBS® Mini Connectors - up to 52 amps

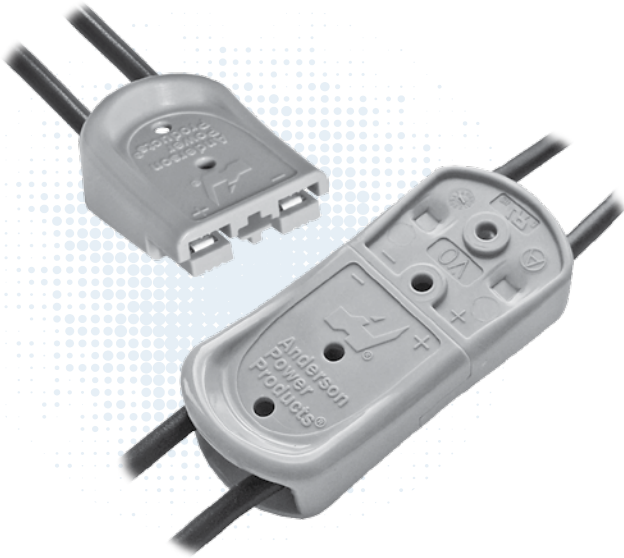

SBS® Mini Connector series is our smallest DC power connector in the SB® group. The SBS® Mini securely holds two crimp and poke contacts with sacrificial tips to enable hot swap capabilities on DC circuits. The low resistance contacts accept 20 to 10 AWG (0.75 to 4.0 mm²) wires allowing up to 52 amps of UL rated performance per position.

- **Touch Safe Housing**
Minimizes potential contact with live circuits
- **Color-Coded Mechanical Key**
Prevents accidental mating of connectors operating at different voltage levels
- **Compact & Ergonomic Housing**
Is “user friendly” during connection and disconnection of the system
- **UL Hot Plug Rated to 45 Amps @ 72 Volts**
Good for applications where the ability to interrupt circuits is required

| SBS® MINI ORDERING INFORMATION |

SBS® Mini Housing

The smallest SBS® connector has 2 finger proof positions in a polycarbonate housing with an ergonomic grip. The housing securely holds crimp and poke contacts from the popular Powerpole® 15-45 series connectors.

Description	- Part Numbers -
Minimum Quantity ...	100
Red	B02265G1
Gray	B02265G4
Blue	B02265G3
Black	B02265G2



Actual Size

Top View

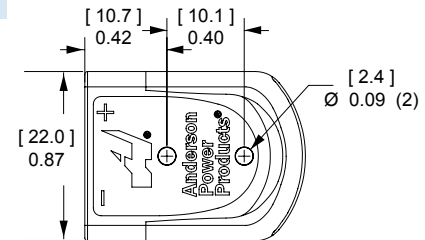

Side View

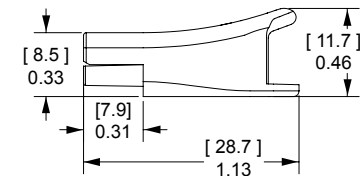

Mated Side View

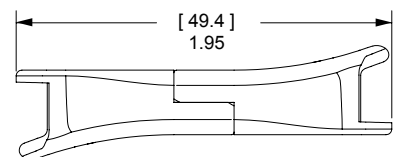

PP15-45 Tin Plated Power Contacts

Offer cost effective performance up to 200 mating cycles. See specifications and temperature charts for amperage ratings by wire size.

Barrel	AWG	mm ²	Loose Piece ----- Part Numbers -----	Reeled	Dimensions - A -	
					inches	mm
Minimum Quantity			200	5,000		
Open	14 to 10 K*	2.1 to 5.3	261G2-LPBK	261G2	0.20	5.08
Open	16 to 12	1.3 to 3.3	261G1-LPBK	261G1	0.18	4.57
Open	20 to 16	0.52 to 1.3	262G1-LPBK	262G1	0.16	4.06

K* - For #10 AWG class K stranded wire or smaller.

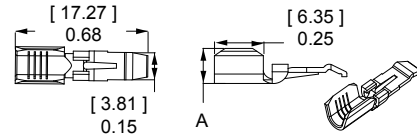

PP15-45 Silver Plated Power Contacts

Maximize performance by offering up to 1,500 mating cycles. Recommended for circuit interrupt or hot plug applications. See specifications and temperature charts for amperage ratings by wire size. Only closed barrel contacts are suitable for soldering.

Barrel	AWG	mm ²	Loose Piece ----- Part Numbers -----	Reeled - Part Numbers -	Dimensions				
					- A -		- B -		
					inches	mm	inches	mm	
Minimum Quantity			5,000	200	5,000				
Open	14 to 10 K*	2.1 to 5.3	-	261G3-LPBK	261G3	0.20	5.08	-	-
Open	20 to 16	0.52 to 1.3	-	262G2-LPBK	262G2	0.16	4.06	-	-
Closed	16 to 12	1.3 to 3.3	1331-BK	1331	-	0.15	3.81	0.10	2.54
Closed	20 to 16	0.52 to 1.3	1332-BK	1332	-	0.12	3.05	0.07	1.78

K* - For #10 AWG class K stranded wire or smaller.

Open Barrel Contact

Closed Barrel Contact

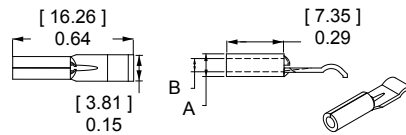
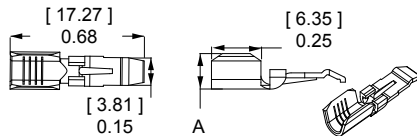

SBS® Mini - Tooling Information

Wire Size		Loose Piece Part Numbers			Reeled Part Numbers		Reeled Contact Crimp Tools				
AWG	mm ²	Tin Plating	Silver Plating	Hand Tool or	Tin Plating	Silver Plating	APP Applicator	APP Press	ATS Applicator	ATS Press	Air Feed Kit*
16 / 20	1.3 / 0.52	N/A	1332	1309G2 or 1309G8	N/A	N/A	N/A	N/A	N/A	N/A	N/A
12 / 16	3.3 / 1.3	N/A	1331		N/A	N/A	N/A	N/A	N/A	N/A	N/A
16 / 20	1.3 / 0.52	262G1-LPBK	262G2-LPBK	1309G3 or 1309G8	262G1	262G2	TD0101	115V = TE0101 230V = TE0102	1385519-1	1725900-2	1424266-1
12 / 16	3.3 / 1.3	261G1-LPBK	N/A		261G1	N/A			1385520-1		
10 / 14	5.3 / 2.1	261G2-LPBK	261G3-LPBK		261G2	261G3			1385458-1		

Need More Than 2 Positions?

See the stackable Powerpole® 15 to 45 connectors. These single position connectors use the same contact system as SBS® Mini and can be stacked together to create custom multiple position configurations.



SBS® MINI SPECIFICATIONS |

Electrical		
Current Rating Amperes ¹	UL 1977	CSA
10 AWG	52	35
12 AWG	41	28
14 AWG	31	23
16 AWG	24	16
18 AWG	20	15
Voltage Rating AC/DC		
UL 1977	600	
Dielectric Withstanding Voltage		
Volts AC	2,200	
Avg. Mated Contact Resistance Milliohms ²		
Wire Contact with 5/8" of #16 AWG	0.875	
Wire Contact with 5/8" of #12 AWG	0.600	
Wire Contact with 5/8" of #10 AWG	0.525	
UL Hot Plug Current Rating Amperes ³		
250 cycles at 72V DC	45A	

Materials	
Housing	
Plastic Resin	Polycarbonate
Contact Retention Spring	Stainless Steel
Housing Flammability Rating	
UL94	V-0
Glow Wire	960°C (GWFI) / 800°C (GWIT)
Contact	
Base	Copper Alloy
Plating	Tin or Silver
Contact Termination Methods	
Crimp ³	Wire Contacts
Hand Solder	1331 & 1332

Mechanical		
Wire Size Range	AWG	mm²
	20 to 10	0.75 to 4.0
Max. Wire Insulation Diameter	in.	mm
	0.183	4.65
Operating Temperature	°F	°C
	-4° to 221°	-20° to 105°
Mating Cycles No Load by Plating	Silver (Ag)	Tin (Sn)
10 - 12 AWG	1,500	200
14 - 18 AWG	8,000	200
Avg. Mating / Unmating Force ⁴	Lbf.	N
10 AWG	10 to 11	45 to 49
12 to 18 AWG	4 to 7	17 to 31
Min Contact / Spring Retention Force	Lbf.	N
	20	90

NOTE 1: See IEC 60664-1 for working voltage.

¹ Based on: 105°C rated or better cable of the largest size, Properly calibrated APP recommended tooling, and a 25°C ambient temperature. UL rating not to exceed the maximum operating temperature. CSA rating below a 30°C temperature rise.

² Use APP recommended tooling only. Alternate tools may adversely affect the performance of our connectors along with UL and CSA recognition.

³ Based on 261G3 with 10 AWG wire.

⁴ Contact customer service for contacts with a higher disconnect force.



Inquire with Customer Service for IEC / EN Approvals

| IEC INFORMATION |

Connector Series	Configurations	Creepage/Clearance per IEC 60950-1	Material Group
SBS®Mini	Unmated	1.47 mm	IIIa
	Mated	2.40 mm	

Protection	
Touch Safety	
UL 1977 Sec. 10.2	Pass
IEC 60950	Pass
IEC 60529	IP20

NOTE 2: Refer to the Constructional Data form for additional information on our website., www.andersonpower.com



TEMPERATURE CHARTS | Temperature rise charts are based on a 25°C ambient temperature.

For Temperature Rise Above 60°C, Consult the Extended Temperature Rise Charts in the Appropriate Product Section on the Website.

Current - Temperature Derating per IEC 60512-5-2 Test 5B

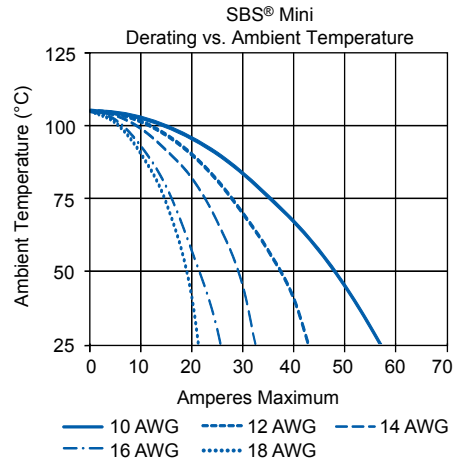
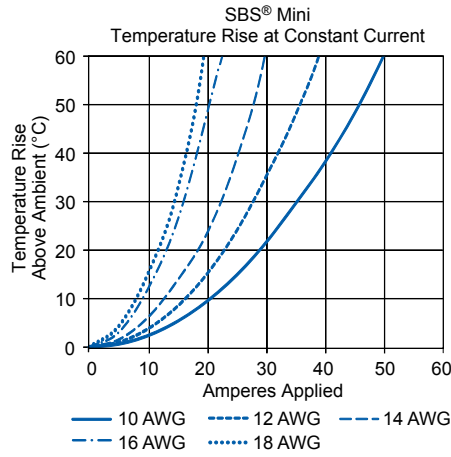

SBS® Connectors - up to 110 amps

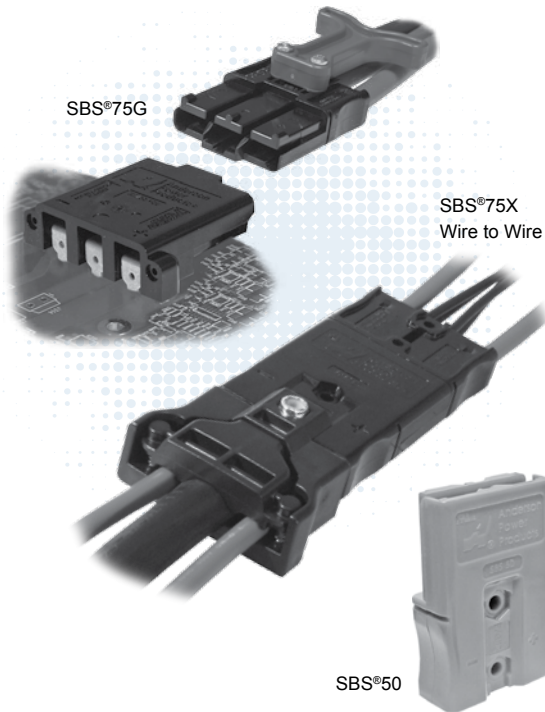

The patented SBS® connector family is designed to provide high power in a compact ergonomic housing with protection against accidental contact with live circuits. This is of particular importance in applications where DC voltages exceed 30 volts and can be health threatening.

Wire-to-wire and wire-to-board configurations both provide power contacts rated up to 110 amps. The SBS®75X offers up to 4 mate-last break-first auxiliary power / signal contacts rated up to 20 amps. The SBS®75G features a third first-mate last-break ground or power contact. All contact positions are rated for circuit interruption (hot plugging).

- **Touch Safe Interface**
 - Can safely be used in through panel applications
 - Minimizes potential contact with live circuits per IEC 60950
- **Wire-to-Wire and Wire-to-Board Configurations**
 - Allows one connector to meet multiple needs
- **Ground or Auxiliary Positions Integrated into the One Piece Housing**
 - Meets all connection requirements in one compact connector housing

| SBS® ORDERING INFORMATION |

SBS®50 Standard Housings

Polycarbonate housings feature 2 positions all finger proof. Genderless design mates with itself. Mechanical keys are color coded.

Description	----- Part Numbers -----	
Minimum Quantity	500	50 ...
Red	SBS50RED-BK	SBS50RED
Gray	SBS50GRA-BK	SBS50GRA
Blue	SBS50BLU-BK	SBS50BLU
Black	SBS50BLK-BK	SBS50BLK
Brown	SBS50BRN-BK	SBS50BRN
White	SBS50WHT-BK	SBS50WHT

SBS®50 Chemical Resistant (CR) Housings

Same features as the standard housings, but molded out of a chemical resistant PBT/ PC blend. Suitable for use to -40°C.

Description	----- Part Numbers -----	
Minimum Quantity	500	50 ...
Red	PSBS50RED-BK	PSBS50RED
Gray	PSBS50GRA-BK	PSBS50GRA
Blue	PSBS50BLU-BK	PSBS50BLU
Green	PSBS50GRN-BK	PSBS50GRN
Black	PSBS50BLK-BK	PSBS50BLK
Brown	PSBS50BRN-BK	PSBS50BRN

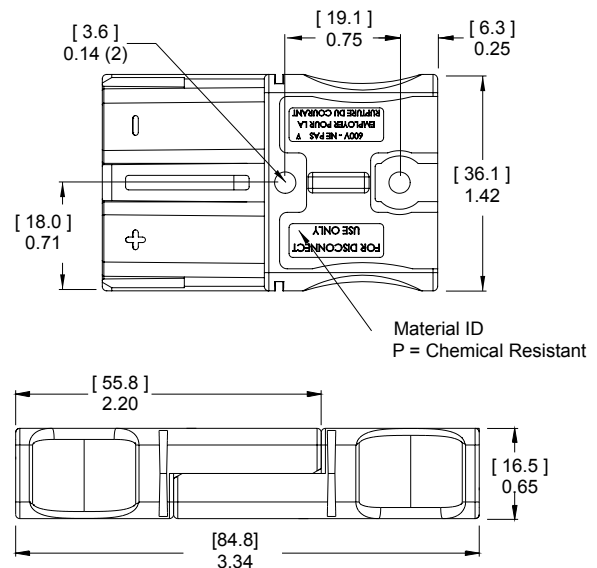

SBS®75X Standard Housings

Polycarbonate housings feature 4 auxiliary and 2 primary positions all finger proof. Genderless design mates with itself, or the PCB connector. Mechanical keys are color coded.

Description	----- Part Numbers -----	
Minimum Quantity	250	50
Black	SBS75XBLK-BK	SBS75XBLK
Brown	SBS75XBRN-BK	SBS75XBRN

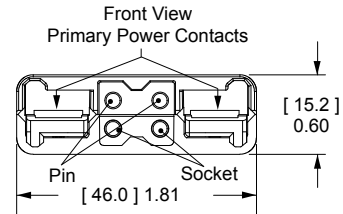

SBS®75X Chemical Resistant (CR) Housings

Same features as the standard housings, but molded out of a chemical resistant PBT/ PC blend. Suitable for use to -40°C.

Description	----- Part Numbers -----	
Minimum Quantity	250	50
Green	PSBS75XGRN-BK	-
Black	PSBS75XBLK-BK	PSBS75XBLK

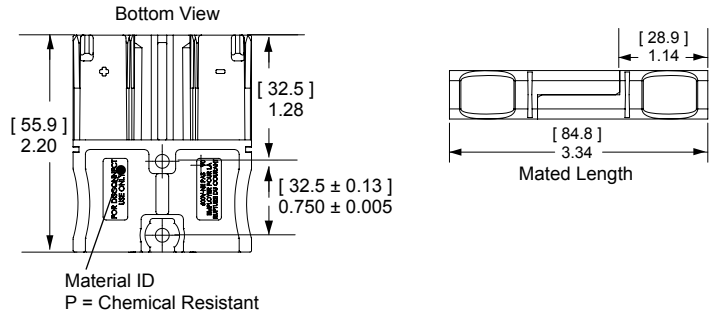

SBS®75X Assembled PCB Connector

Fully assembled PCB connector is designed to mate with SBS®75X Wire connector. All positions are preloaded with contacts including standard mating length auxiliary positions. Press fit board locks help secure the connector to the PCB before and after soldering.

Description	--- Part Number ---
Minimum Quantity	100
Black	SBS75XPRBLK-BK

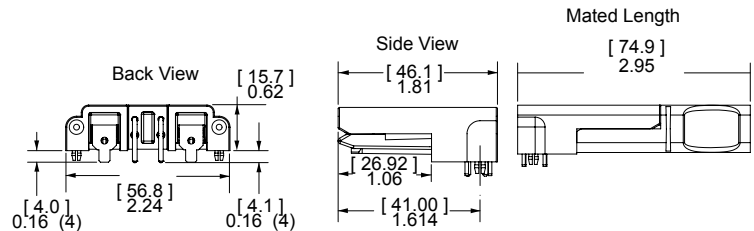

See PCB connector drawing on website for further detail.

SBS®75G Wire Housings

Polycarbonate housings feature three finger proof positions. The center position can be used for pre-mate power or ground. Genderless design mates with itself, or the PCB connector. Mechanical keys are color coded. Inquire with customer service for chemical resistant housings.

Description	----- Part Numbers -----	
Minimum Quantity	250	50
Blue	SBS75GBLU-BK	SBS75GBLU
Black	SBS75GBLK-BK	SBS75GBLK
Brown	SBS75GBRN-BK	SBS75GBRN
White	SBS75GWHT-BK	SBS75GWHT

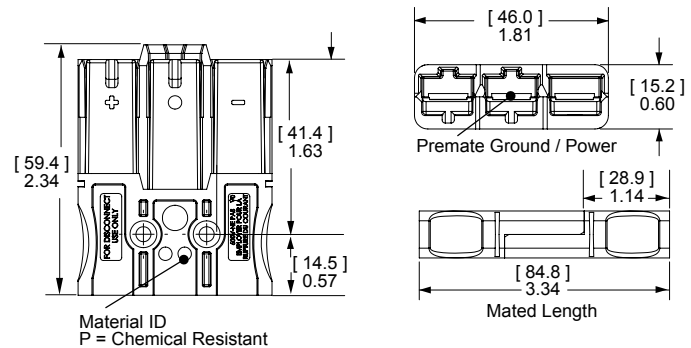

SBS®75G Assembled PCB Connector

Fully assembled PCB connector is designed to mate with SBS®75G Wire connector. Has press fit board locks to help secure the connector to the PCB before and after soldering.

Description	--- Part Number ---
Minimum Quantity	100
Black	SBS75GPRBLK-BK

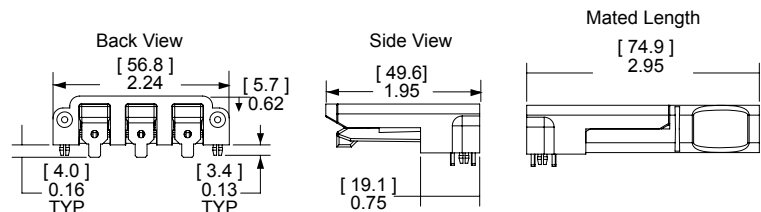

See PCB connector drawing on website for further detail.

SBS® Silver Plated Primary Power Wire Contacts

Use two silver plated contacts per housing for the best electrical performance and durability up to 10,000 mating cycles. Standard contacts are for use in all primary power positions for SBS® 50, 75X, & 75G wire housings. See reducing bushings in accessory section for smaller wires. See reducing busings in accessory section for smaller wires.

Type	AWG	mm ²	Loose Piece		Dimensions	
			----- Part Numbers -----	----- Part Numbers -----	- A -	
Minimum Quantity			1,000	100		
Standard	6	16	1339G2-BK	1339G2*	0.22	5.59
Standard	8	10	1339G5-BK	1339G5*	0.19	4.83
Standard	12 to 10	2.5 to 6	1339G3-BK	1339G3*	0.14	3.56

* Are sold as pairs. 2 contacts ship for every 1 ordered.

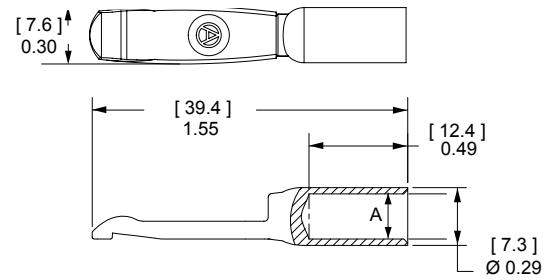

SBS®75G Silver Plated Pre-Mate Wire Contacts

Pre-Mate contacts are for the center Pre-Mate position on the SBS®75G wire housings. See reducing bushings in accessory section for smaller wires.

Type	AWG	mm ²	Loose Piece		Dimensions	
			----- Part Numbers -----	----- Part Numbers -----	- A -	
Minimum Quantity			500	50		
Pre-Mate	6	16	1340G1-BK	1340G1	0.22	5.59
Pre-Mate	8	10	1340G2-BK	1340G2	0.19	4.83
Pre-Mate	12 to 10	2.5 to 6	1340G3-BK	1340G3	0.14	3.56

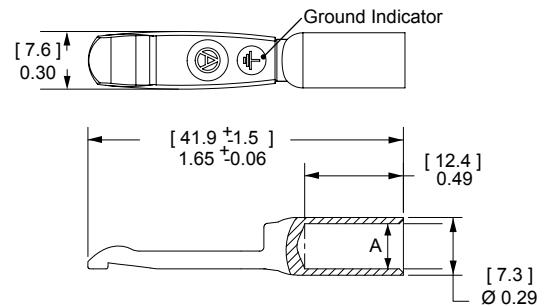

Pin Contacts for SBS®75X Auxiliary

Gold plated contacts are available in 3 lengths to allow sequencing of circuits.

Description	AWG	mm ²	----- Part Numbers -----	
			----- Part Numbers -----	----- Part Numbers -----
Minimum Quantity			500	50
Standard Length 7.7mm	12	2.5	PM16P12S30	PM16P12S30-50
	16 to 14	1.0 to 1.5	PM16P1416S30	PM16P1416S30-50
	20 to 16	0.75 to 1.0	PM16P1620S30	PM16P1620S30-50
	24 to 20	0.50 to 0.75	PM16P2024S30	PM16P2024S30-50
Pre-Mate 9.3mm	12	2.5	PM16P12A30	-
	16 to 14	1.0 to 1.5	PM16P1416A30	-
	20 to 16	0.75 to 1.0	PM16P1620A30	-
	24 to 20	0.50 to 0.75	PM16P2024A30	-
Post-Mate 6.4mm	12	2.5	PM16P12C30	-
	16 to 14	1.0 to 1.5	PM16P1416C30	-
	20 to 16	0.75 to 1.0	PM16P1620C30	-
	24 to 20	0.50 to 0.75	PM16P2024C30	-

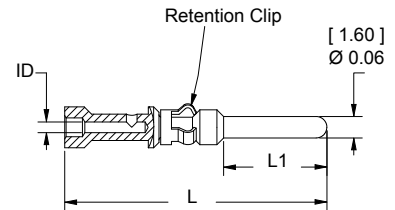

Auxiliary Pin Contact Lengths	- L -		- L1 -	
	in.	mm	in.	mm
Standard Length 7.7mm	0.77	19.6	0.30	7.7
Pre-Mate 9.3mm	0.83	21.2	0.37	9.3
Post-Mate 6.4mm	0.72	18.3	0.25	6.4

Socket Contacts for SBS®75X Auxiliary

Selectively gold plated contacts offer low resistance and durability up to 10,000 mating cycles.

Description	AWG	mm ²	----- Part Numbers -----	
			----- Part Numbers -----	----- Part Numbers -----
Minimum Quantity			500	50
Socket Contact	12	2.5	PM16S12S32	PM16S12S32-50
	16 to 14	1.0 to 1.5	PM16S1416S32	PM16S1416S32-50
	20 to 16	0.75 to 1.0	PM16S1620S32	PM16S1620S32-50
	24 to 20	0.50 to 0.75	PM16S2024S32	PM16S2024S32-50

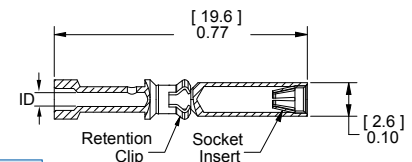

Auxiliary Socket Contacts Crimp Barrel ID

Wire Gauge	in.	mm.
#24 / 20	0.04	1.1
#20 / 16	0.07	1.7
#16 / 14	0.08	2.1
#12	0.10	2.6

SBS® CONNECTOR SPECIFICATIONS

Electrical

Current Rating Amperes ¹	UL 1977	CSA/TUV
Primary Power (6 AWG)	110	75
Auxiliary (12 AWG)	20	10
Voltage Rating AC/DC		
UL 1977	600	
Dielectric Withstanding Voltage		
Volts AC	2,200	
Avg. Mated Contact Resistance Milliohms ¹		
Power & Ground: 1 1/4" of #6 AWG wire	0.200	
Auxiliary: Wire & PCB	3.000	
UL Hot Plug Current Rating Amperes - 250 cycles at 120V DC		
Wire & PCB Power	50A	
Wire & PCB Auxiliary	5A	
UL Ground Short Time Current Test - SBS75G Wire & PCB		
1530 Amps, #6 AWG Wire	6 seconds	

Materials

Housing	
Standard Plastic Resin	Polycarbonate
Chem. Resistant Resin	Polycarbonate / PBT blend
Contact Retention Spring	Stainless Steel
Housing Flammability Rating	
UL94	V-0
Glow Wire - SBS50	825°C (GWFI) / 800°C (GWIT)
- SBS75G	960°C (GWFI) / 800°C (GWIT)
- SBS75X	960°C (GWFI) / 800°C (GWIT)
Wire Power & Ground Contact	Silver Plated Copper Alloy
PCB Power & Ground Contact	Tin Plated Copper Alloy
SBS75X Auxiliary Contacts	
Pin	Copper alloy, Au over Ni
Socket	BeCu, Au over Ni
Socket Body	Copper alloy, Sn bright over Ni
Retention Clip	Stainless Steel
PCB Press Fit Retainers	Brass - Tin Plated
Contact Termination Methods	
Crimp ³	Wire Contacts
Hand Solder	Wire and PCB Contacts
Solder Dip	PCB Contacts
Wave Solder	PCB Contacts

Mechanical

Wire Size Range	AWG	mm²	
Power Contacts (with bushings)	16 to 6	1.3 to 13.3	
Auxiliary Contacts	24 to 12	0.25 to 3.3	
Max. Wire Insulation Diameter			
SBS®75G Power & Ground	in.	mm	
SBS®50 & SBS®75X Power Contacts	0.380	9.652	
SBS®75X Auxiliary Contacts	0.410	10.414	
	0.140	3.600	
Operating Temperature ²			
Standard	°F	°C	
Chemical Resistant	-4° to 221°	-20° to 105°	
	-40 to 221°	-40° to 105°	
Mating Cycles No Load by Plating			
Power & Ground Contacts Wire	Silver (Ag)	Tin (Sn)	Gold (Au)
Power & Ground Contacts PCB	10,000	1,500	
Auxiliary Contacts			10,000
Avg. Mating / Unmating Force			
SBS®75X and SBS®75G Wire to Wire	Lbf.	N	
SBS®50 Wire to Wire	16	70	
SBS®75X and SBS®75G Wire to PCB	8	36	
	8	36	
Min. Contact / Spring Retention Force			
Power, Standard Housing	Lbf.	N	
Power, Chem. Resistant Housing	50	222	
Aux. Standard Housing	30	133	
Aux. Chem. Resistant Housing	15	67	
	10	44	
PCB Specifications			
Mounting Style	Plated Through Hole		
Max PCB Thickness- in. [mm]	0.093 [2.4]		
Recommended Traces Power & Ground	#6 AWG Cross Section		
Recommended Traces Auxiliary	#12 AWG Cross Section		
Min. Creepage / Clearance Distance PCB			
Power to Aux. Creepage SBS®75X	in.	mm	
Power to Aux. Clearance SBS®75X	0.41	10.4	
Power to Ground Creepage SBS®75G	0.24	6.1	
Power to Ground Clearance SBS®75G	0.35	8.9	
Auxiliary Creepage SBS®75X	0.26	6.7	
Auxiliary Clearance SBS®75X	0.12	3.0	
	0.12	3.0	



File No. E26226



CSA Certified
File No. LR25154



Auxiliary contacts are available for SBS®75X only.

SBS®75X and SBS®75G PCB connectors are designed to mate only with the wire connector of the same series.

NOTE 1: See IEC 60664-1 for working voltage.

NOTE 2: Amp ratings are stated per position and based on all positions being fully loaded.

¹ Based on: 105°C rated or better cable of the largest size, Properly calibrated APP recommended tooling, and a 25°C ambient temperature.

UL rating not to exceed the maximum operating temperature. CSA rating below a 30°C temperature rise.

² Limited by the thermal properties of the connector plastic housing.

³ Use APP recommended tooling only. Alternate tools may adversely affect the performance of our connectors along with UL and CSA recognition.

IEC INFORMATION |

Connector Series	Configurations	Creepage/Clearance per IEC 60950-1	Material Group
SBS®75G	Unmated	3.33 mm	IIIa
	Mated	4.64 mm	

Connector Series	Configurations	Creepage/Clearance per IEC 60950-1	Material Group
SBS®75X	Unmated	3.33 mm	IIIa
	Mated	4.64 mm	

Connector Series	Configurations	Creepage/Clearance per IEC 60950-1	Material Group
SBS®50	Unmated	3.85 mm	IIIa
	Mated	4.64 mm	

Protection	
Touch Safety with Wire Contacts & PCB Mating Interface	
IEC 60950	Pass
IEC 60529	IP20

Attributes	SBS50
AMP Rating AC/DC - Power only	6 AWGg-75a, 8 AWG 65A - 10 AWG - 45A, 12 AWG -35a
Power Contacts and Aux contacts (Aux contacts at 15 A)	6 AWGg-75a, 8 AWG 60A - 10 AWG - 35A, 12 AWG -30a
- Aux Contacts	12 AWG - 15A
Voltage Rating AC/DC (Steady State)	600 AC/DC (Operational)
- Aux Contacts	NA
Breaking Capacity -AMP Rating /Cycles - Power Contacts	6 AWG -50 Amp, 120 VDC / 250 Cycles
Breaking Capacity - Aux Contacts	NA
Voltage Rating (Breaking Capacity)	120 VDC
Finger Safety - Mated only	IEC 60529 - IP20
Wire Size tested	Power 12, 10, 8, 6 AWG
Contact Series Tested	1339G2, 1339G3, 1339G5
- Aux contacts	NA
Climatic Testing (Cold,Heat & MFG)	IEC 60512 Test -11j, 11i & 11g,
Cycle Life	IEC 60512 Test 9a - 5000 Cycles
Mechanical Strength Impact	IEC 60512-5 @ 29.5 Inches - dropped 8 times
Temperature Range	-20 °C to 105 °C -4 °F to 221 °F

Attributes	SBS75x
AMP Rating AC/DC - Power only	6 AWGg-75a, 8 AWG 65A - 10 AWG - 45A, 12 AWG -35a
Power Contacts and Aux contacts (Aux contacts at 15 A)	6 AWGg-75a, 8 AWG 60A - 10 AWG - 35A, 12 AWG -30a
- Aux Contacts	12 AWG - 15A
Voltage Rating AC/DC (Steady State)	600V AC/DC (Operational)
- Aux Contacts	12 AWG - 15A
Breaking Capacity -AMP Rating /Cycles - Power Contacts	6 AWG- 50 Amp, 120 VDC / 250 Cycles
Breaking Capacity - Aux Contacts	12 AWG -5A, 120 VDC / 250 Cycles
Voltage Rating (Breaking Capacity)	120 VDC
Finger Safety - Mated only	IEC 60529 - IP20
Wire Size tested	Power 12 AWG, 10 AWG , 8 AWG, 6AWG / signal 12 awg
Contact Series Tested	Power 1339G2, 1339G3, 1339G5
- Aux contacts	PM16P12S30, PM16S12S32
Climatic Testing (Cold,Heat & MFG)	IEC 60512 Test -11j, 11i & 11g,
Cycle Life	IEC 60512 Test 9a - 5000 Cycles
Mechanical Strength Impact	IEC 60512-5 @ 29.5 Inches - dropped 8 times
Temperature Range	-20 °C to 105 °C -4 °F to 221 °F



NOTE 3: Refer to the Constructional Data form for additional information on our website., www.andersonpower.com

Attributes	SBS75G
AMP Rating AC/DC - Power only	110
Power Contacts and Aux contacts (Aux contacts at 15 A)	NA
- Aux Contacts	NA
Voltage Rating AC/DC (Steady State)	600V AC/DC (Operational)
- Aux Contacts	NA
Breaking Capacity -AMP Rating /Cycles - Power Contacts	6 AWG- 50 A, 120 VDC / 250 Cycles
Breaking Capacity - Aux Contacts	NA
Voltage Rating (Breaking Capacity)	120 VDC
Finger Safety - Mated only	IEC 60529 - IP10, IP20
Wire Size tested	6 AWG
Contact Series Tested	Power 1339G2, 1339G3, 1339G5 / Ground 1340G1
- Aux contacts	NA
Climatic Testing (Cold,Heat & MFG)	IEC 60512 Test -11j, 11i & 11g,
Cycle Life	IEC 60512 Test 9a - 1500 Cycles
Mechanical Strength Impact	IEC 60512-5 @ 29.5 Inches - dropped 8 times
Temperature Range	-20 °C to 105 °C -4 °F to 221 °F

Attributes	SBS75G and GPR (PCB)
AMP Rating AC/DC - Power only	110
Power Contacts and Aux contacts (Aux contacts at 15 A)	NA
- Aux Contacts	NA
Voltage Rating AC/DC (Steady State)	600V AC/DC (Operational)
- Aux Contacts	NA
Breaking Capacity -AMP Rating /Cycles - Power Contacts	6 AWG- 50 A,120 VDC / 250 Cycles
Breaking Capacity - Aux Contacts	NA
Voltage Rating (Breaking Capacity)	120 VDC
Finger Safety - Mated only	IEC 60529 - IP20
Wire Size tested	6 AWG
Contact Series Tested	Power B02075P1 / Ground B02114P1
- Aux contacts	NA
Climatic Testing (Cold,Heat & MFG)	IEC 60512 Test -11j, 11i & 11g,
Cycle Life	IEC 60512 Test 9a - 1500 Cycles
Mechanical Strength Impact	NA
Temperature Range	-20 °C to 105 °C -4 °F to 221 °F



NOTE 3: Refer to the Constructional Data form for additional information on our website., www.andersonpower.com

SBS® CONNECTOR TEMPERATURE CHARTS | Temperature rise charts are based on a 25°C ambient temperature.

For Temperature Rise Above 60°C, Consult the Extended Temperature Rise Charts in the Appropriate Product Section on the Website.

Current - Temperature Derating per IEC 60512-5-2 Test 5B

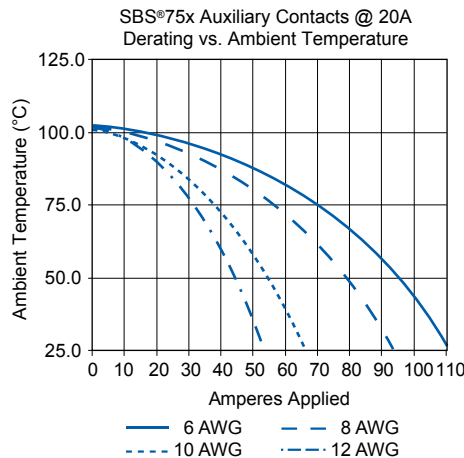
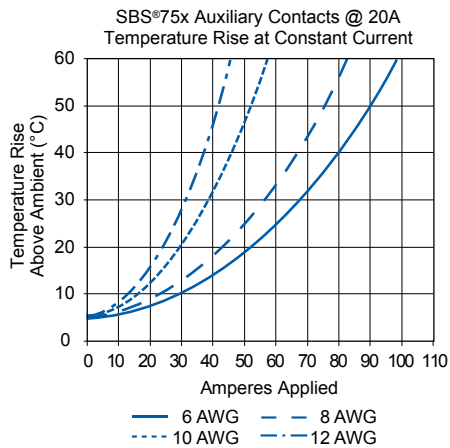
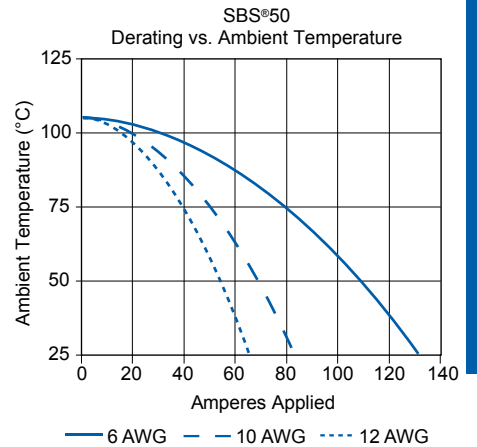
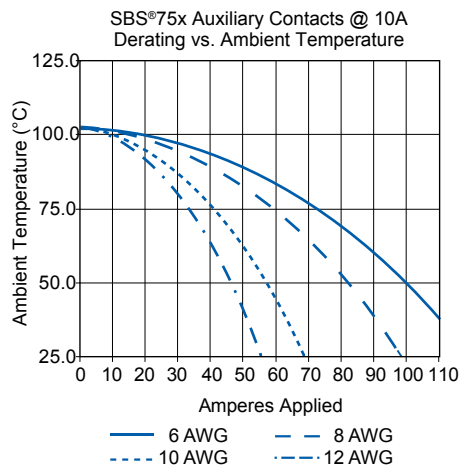
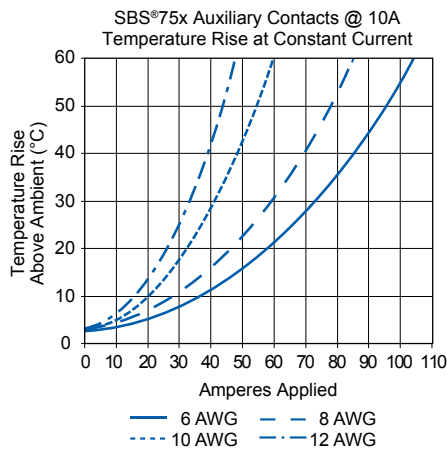
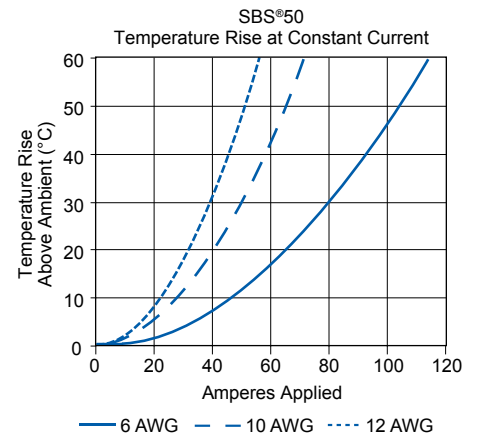
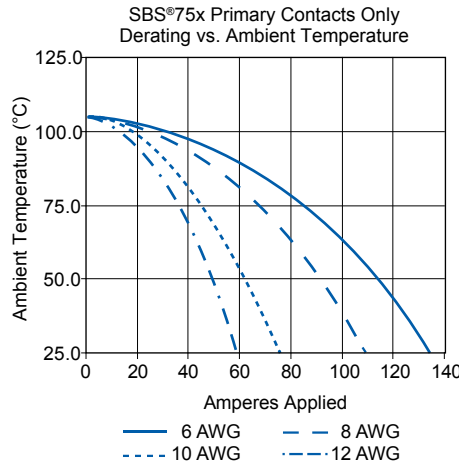
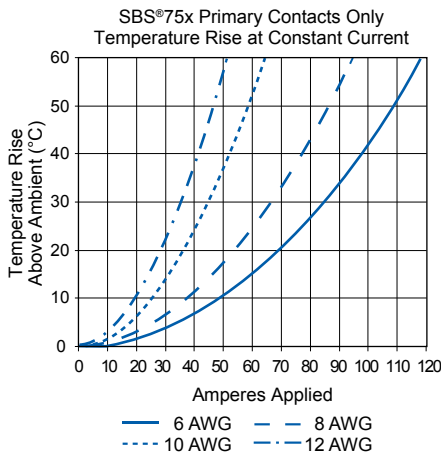

SECTION 3
SBS® 50 & 75

For Temperature Rise Above 60°C, Consult the Extended Temperature Rise Charts in the Appropriate Product Section on the Website.

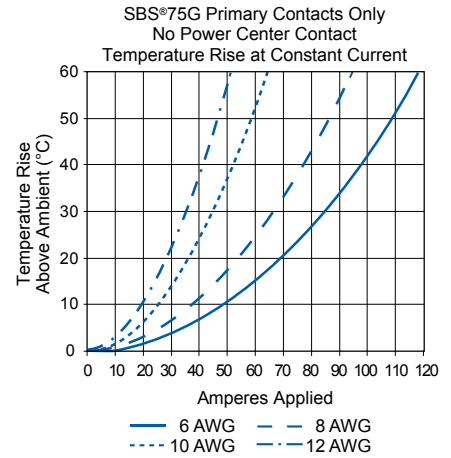
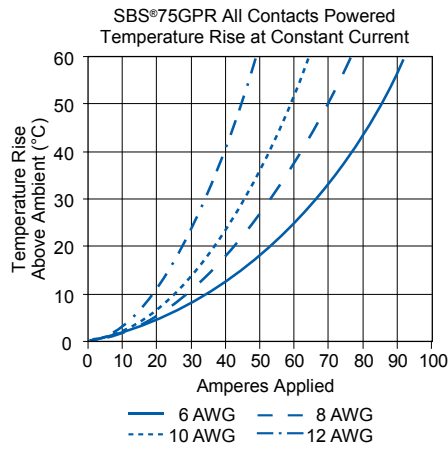
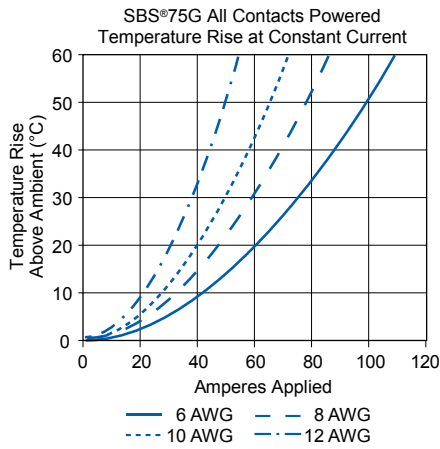

Current - Temperature Derating per IEC 60512-5-2 Test 5B

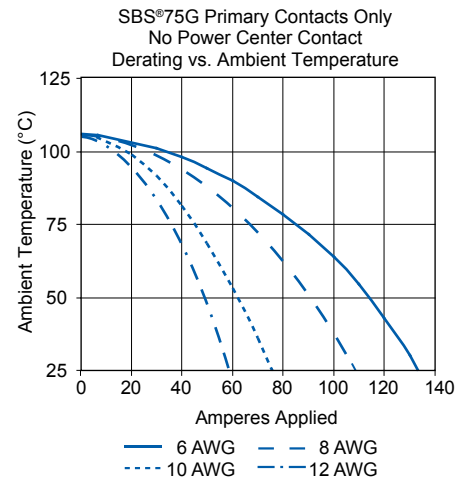
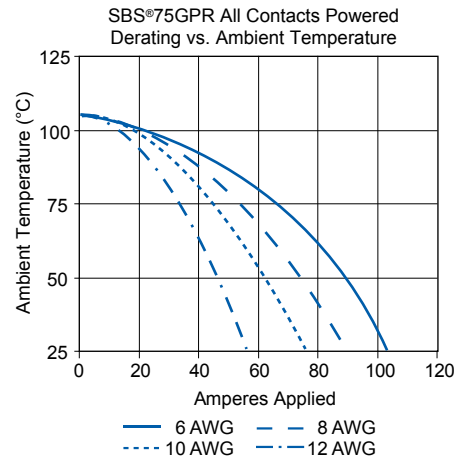
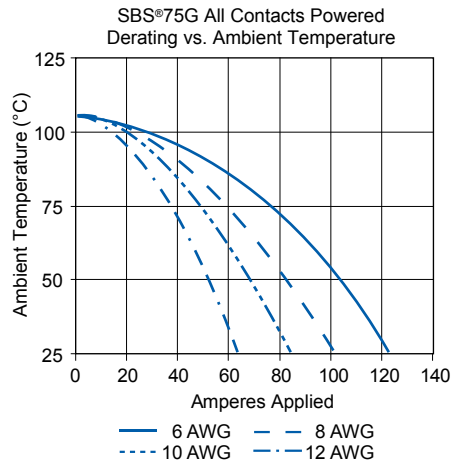

SBS® ACCESSORIES |

Mounting Clamp for SBS®50

Mounting clamps can be used for fastening a SBS®50 series housings to a panel. Fastening hardware not included.

Description	--- Part Number ---
Minimum Quantity	20 sets of 2
Panel Mount Bracket for SBS®50	1466G1

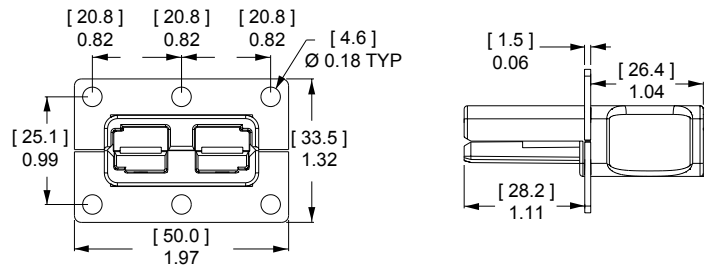

T-Handle for SBS®50 and SBS®75X

The "T" handle makes mating and unmating the connector easier. The non-conductive red plastic material is strong and safe. (2) Self tapping screws are used to secure the handle to the connector housing.

Description	----- Part Numbers -----
Minimum Quantity	1,000 50
Red "T" Handle + Hardware Bag	- SBS50-HDL-RED
Hardware Bag (2 Screws)	- 104G17
Red "T" Handle Only	113899P1 -
#8 x 5/8" Screw (Order 2 Per Handle)	H1120P55 -

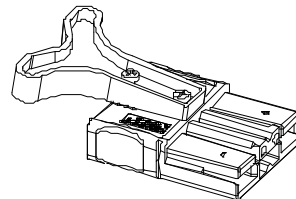

"A" frame handle for SBS®50 and SBS®75X

Handle makes mating and unmating the connector easier. The non-conductive gray plastic material is strong and safe. Machine screws and locknuts included.

Description	- Part Number -
Minimum Quantity	200
Gray "A" Handle & Hardware	997G1

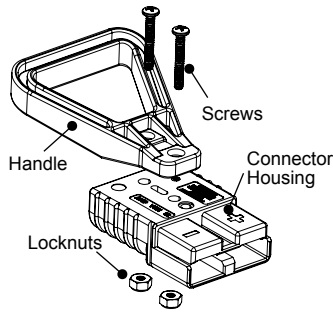

T-Handle for SBS®75G

The "T" handle makes mating and unmating the connector easier. The non-conductive red plastic material is strong and safe. (2) Machine screws and lock nuts.

Description	- Part Number -
Minimum Quantity	50
Red "T" Handle + Hardware Bag	SBS75GHDLRED

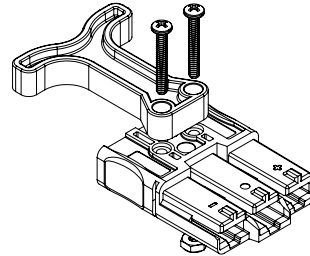

Dust Cover SBS®50

Prevents dust and dirt from entering the mating interface of the connector when unmated. NOTE: Not a Hermetic Seal.

Description	----- Part Number -----
Minimum Quantity	500 50 ...
Dust Cover with Lanyard Strap, Red	113890P1 134G1

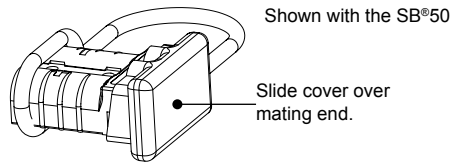

Cable Clamps for SBS®50

Durable metal cable clamps securely hold cables to prevent accidental strain or pulls from dislodging wire or contacts from the housing. Cable clamps are recommended for solder terminated wires.

Description	Cable Size		----- Part Numbers -----	
	AWG or (Inches O.D.)	mm ² or (mm O.D.)		
Minimum Quantity			500	50 ...
Self Attaching for Discrete Conductor	8 to 6	10	990-BK	990
Self Attaching for Discrete Conductor	12 to 10	2.5 to 4	990G2-BK	990G2
Bolt On for Discrete Conductor	12 to 6	2.5 to 10	990G1-BK	990G1
Bolt On for Bundled Conductor	(0.320 to 0.450)	(4.27 to 11.43)	5905-BK	5905

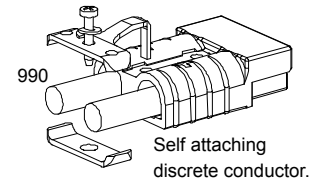
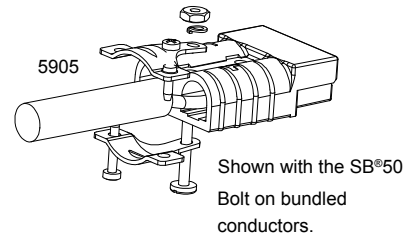

The given wire O.D. information is an estimate. Cable clamps should be evaluated for performance with the actual wire to be used.

Cable Clamps for SBS®75X with Integral Handle

Rugged chemical resistant PBT/ PC plastic cable clamps securely hold cables to prevent accidental strain or pulls from dislodging wire or contacts from the housing. Cable clamps are recommended for solder terminated wires.

Description	Cable Size AWG or (Inches O.D.)	mm ² or (mm O.D.)	----- Part Numbers -----	
Minimum Quantity			100	25
Large Wire Clamp Kit w/ Hardware	12 to 6 (0.39 to 0.60)	4 to 10 (9.9 to 15.2)	PSBS75XCLP1-BK	PSBS75XCLP1
Small Wire Clamp Kit w/ Hardware	12 to 6 (0.34 to 0.55)	4 to 10 (8.6 to 14.0)	PSBS75XCLP2-BK	PSBS75XCLP2

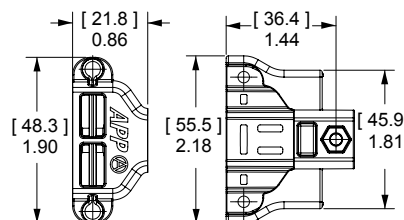

The given wire O.D. information is an estimate. Cable clamps should be evaluated for performance with the actual wire to be used.

Clamp hardware requires phillips or flat blade screwdriver to assemble.

Reducing Bushings

Use with contact part number 1339G2-BK or 1340G1-BK to allow a smaller wire to be used with the connector. Electrical capability is derated with smaller wire.

Contact Barrel Size	Wire Size	Part Numbers			Dimensions			
		-----	-----	-----	- ID -	- Length -	- ID -	- Length -
Minimum Quantity		3,000	1,000	100	inches	mm	inches	mm
#6 AWG [13.3 mm ²]	#8 AWG [8.4 mm ²]	-	5912-BK	5912	0.18	4.57	0.45	11.43
#6 AWG [13.3 mm ²]	#12- 10 AWG [3.3- 5.3 mm ²]	5910-BK	-	5910	0.14	3.56	0.47	11.94
#6 AWG [13.3 mm ²]	#16- 14 AWG [1.3- 2.1 mm ²]	5913-BK	-	5913	0.09	2.29	0.47	11.94

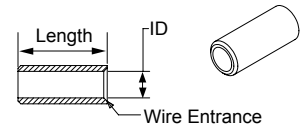

SBS® - Tooling Information

Wire Size		Power / Ground Contacts								
AWG	mm ²	Power Contact Part Number	Pneumatic Bench Tool	+	Die	+	Locator	Number of Crimps	or	Hand Tool
#6	13.3	1339G2	1387G1		1388G6		1389G9	Single		1309G4
#8	8.4	1339G5			1388G7					
#10 / 12	5.3 / 3.3	1339G3			1388G6		1389G20			
#6	13.3	1340G1			1388G7					
#8	8.4	1340G2								
#10 / 12	5.3 / 3.3	1340G3								

Wire Size		SBS®75X Auxiliary Contacts								
AWG	mm ²	Auxiliary Contact Part Number	APP Hand Tool w/ Integral Locator	or	Mil Std. Hand Tool* M22520/1-01	or	Pneumatic Tool*	Number of Crimps	+	Locator for: TM0001 & TP0001
#12 / 24	2.5 / 0.25	All Crimp Pins	PM1000G1		TM0001		TP0001	Single		TL0001
		All Crimp Sockets							TL0002	

* TP0001 and TM0001 tools require locators TL0001 for Pins and TL0002 for Sockets.
NOTE: See website for the most current information.

SBS®75X Auxiliary Contact Insertion Tool: PM1002G1
SBS®75X Auxiliary Contact Extraction Tool: PM1003G1
SBS®75X Auxiliary Contact Insertion Inspection Tool: PM1003GX

The auxiliary contacts used with wire sizes #16 - #24 AWG cannot be properly inserted without the insertion tool. Properly installed auxiliary contact of all wire gauges cannot be removed from the hosing without the extraction tool.

SECTION 3
SBS® 50 & 75

SB® 50 Connectors - up to 120 amps

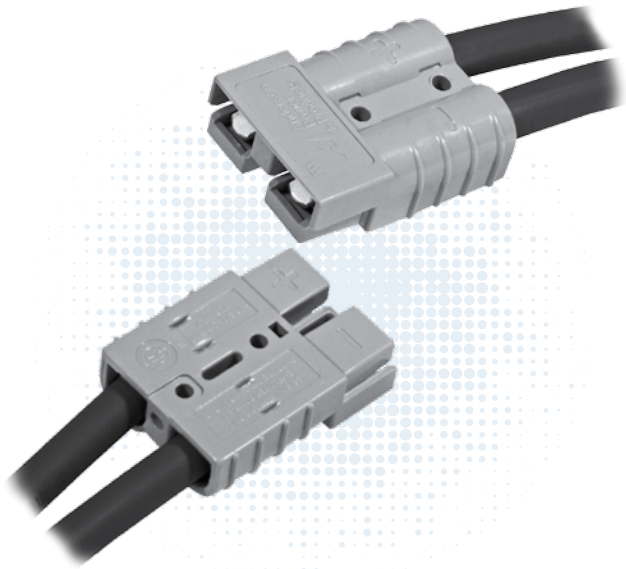

Based off the design pioneered by Anderson in 1953, the two pole SB® connectors set the standard for DC power distribution and battery connections. SB®50 connectors feature a one piece plastic housing using stainless steel springs to hold low resistance contacts in place. Wires sizes from #16 (1.5 mm²) to #6 (13.3 mm²) are held in the smallest of the SB® series housings.

- **Low Resistance Silver or Tin Plated Copper Contacts**
Allows UL rated currents up to 120 amps
- **UL Rated for Hot Plugging up to 50 Amps**
Great for battery or other applications where the ability to interrupt circuits is required
- **Wire, PCB, and Busbar Contacts**
Allows one connection system to meet multiple needs

| SB50® ORDERING INFORMATION |

SB®50 Standard Housings

The smallest SB® housings work with wire contacts up to 6 AWG [10 mm²] as well as PCB, and busbar contacts. Genderless design mates with itself. Mechanical keys are color coded.

Description	---- Part Numbers ----	
Minimum Quantity	500	100 ...
Yellow	992G5-BK	992G5
Orange	992G7-BK	992G7
Red	992G1-BK	992G1
Gray	992-BK	992
Blue	992G4-BK	992G4
Green	992G6-BK	992G6
Black	992G2-BK	992G2

NOTE: SB®50 Black and Gray housings have the same keying features and can be intermated.

SB®50 Chemical Resistant Housings

Same features as the Standard SB®50 but molded in a chemical resistant PBT/ PC blend. Suitable for use to -40°C.

Description	---- Part Numbers ----	
Minimum Quantity	500	100 ...
Red	P992G1-BK	P992G1
Gray	P992-BK	P992
Black	P992G2-BK	P992G2

NOTE: SB®50 Black and Gray housings have the same keying features and can be intermated.

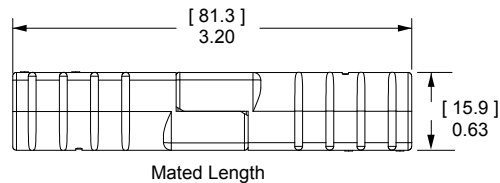
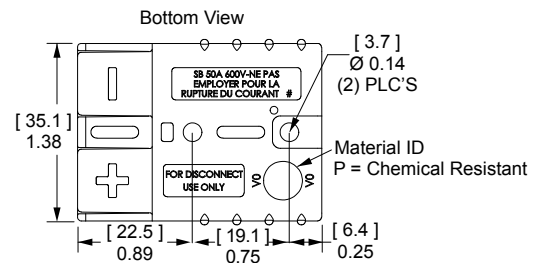

SB®50 Silver Plated Wire Contacts

Use two silver plated contacts per housing for the best electrical performance and durability up to 10,000 mating cycles. See redushing bushings in accessory section for smaller wires.

AWG	mm ²	Mating Force	Loose Piece		Dimensions	
			--- Part Numbers ---		- A -	
Minimum Quantity			1,000	100	inches	mm
6	13.3	Low	1307-BK	1307	0.22	5.59
6	13.3	High	5900-BK	5900	0.22	5.59
8	8.4	High	5952-BK	5952	0.19	4.83
12 to 10	3.3 to 5.3	Low	5953-BK	5953	0.14	3.56
12 to 10	3.3 to 5.3	High	5915-BK	5915	0.14	3.56

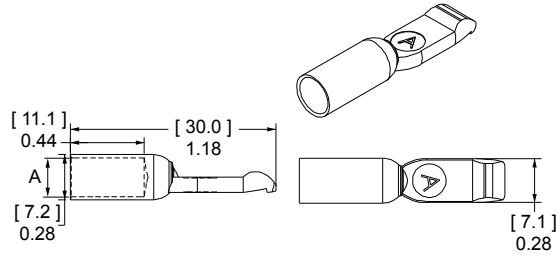

SB®50 Silver Plated Busbar Contacts

Use 2 busbar contacts per housing to provide a quick disconnect input or output busbar connection. Busbar contacts are for mating with wire contacts only. Part number 75BBS includes lock nuts. Locknuts must be ordered separately for B01915P1.

Type	Thread	Mating Force	Loose Piece Part Numbers		
			---	---	---
Minimum Quantity			1,000	20	10 ...
Busbar	#10-24	High	B01915P1	-	75BBS
Lock Nut	#10-24	-	H1216P8	110G54	-

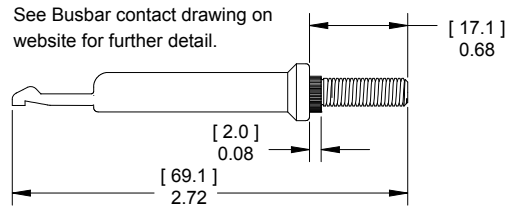

55A Right Angle Standard Powerclaw PCB Contacts

Standard Powerclaw contacts are for use inside a SB®50 housing and provide a color coded right angle connection to the PCB.

Description	- Loose Piece Part Numbers -	
Minimum Quantity	500	100
Tin Plated	PC5930T-BK	PC5930T
Silver Plated	PC5930S-BK	PC5930S

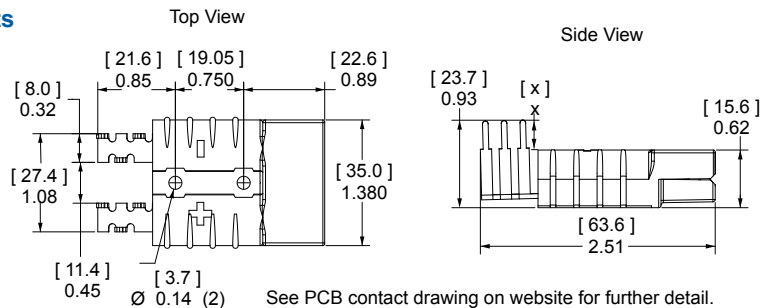

55A Right Angle Mini Powerclaw PCB Contacts

Right angle Mini Powerclaw contacts can be used on the PCB edge without a SB®50 housing on the PCB side. A self polarizing design only allow SB®50 wire housings to mate to PCB contacts one way.

Description	- Loose Piece Part Numbers -	
Minimum Quantity	1,000	100
Tin Plated	PC5934T-BK	PC5934T
Silver Plated	PC5934S-BK	PC5934S

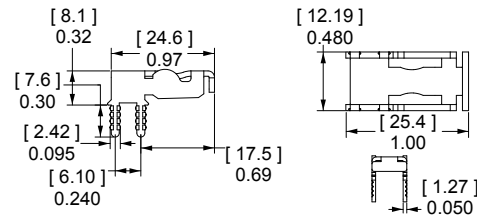

55A Vertical Mini Powerclaw PCB Contacts

Vertical Mini Powerclaw contacts save space by not requiring a SB®50 housing on the PCB side. The guide housing is required for to provide a polarized connection. (See SB®50 accessories).

Description	- Loose Piece Part Numbers -	
Minimum Quantity	1,500	100
Tin Plated	PC5933T-BK	PC5933T
Silver Plated	PC5933S-BK	PC5933S

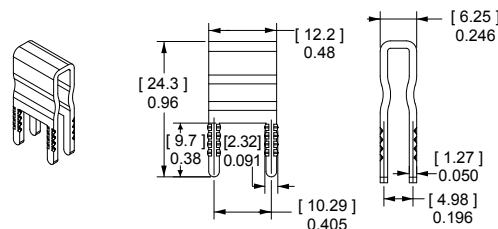

| SB®50 CONNECTOR SPECIFICATIONS |

Electrical

Current Rating Amperes ¹	UL 1977	CSA
Wire to Wire UL 1977 (6 AWG)	120	50
Wire to PCB UL 1977 (6 AWG)	50	
Voltage Rating AC/DC		
UL 1977	600	
PCB Connector Recommended Voltage per IEC 60950-1 Table 2L Pollution Degree²		
Mini Vert. Contact	522	
Mini Horiz. Contact	504	
Standard Contact	950	
Dielectric Withstanding Voltage		
Volts AC	2,200	
Avg. Mated Contact Resistance Milliohms ¹		
1 1/4" of #6 AWG wire	0.200	
PCB Contact to Contact	0.500	
UL Hot Plug Current Rating Amperes - 250 cycles at 120V DC		
Wire- wire	50A	
PCB- wire	40A	
(Vertical Mini Powerclaw)		

Materials

Housing	
Standard Plastic Resin	Polycarbonate
Chem. Resistant Resin	Polycarbonate / PBT blend
Contact Retention Spring	Stainless Steel
Housing Flammability Rating	
UL94	V-0
Glow Wire	960°C (GWFI) / 800°C (GWIT)
Contact	
Base	Copper Alloy
Wire Plating	Silver
PCB Plating	Sn or Ag over Ni
Contact Termination Methods	
Crimp ³	Wire Contacts
Hand Solder	Wire and PCB Contacts
Solder Dip*	PCB Contacts
Wave Solder*	PCB Contacts
Wrench / Socket	Busbar Contacts

Mechanical

Wire Size Range	AWG	mm²
Wire Contacts with Bushings	16 to 6	1.3 to 13.3
Max. Wire Insulation Diameter	in.	mm
	0.440	11.200
Operating Temperature ²	°F	°C
Standard	-4° to 221°	-20° to 105°
Chemical Resistant*	-40 to 221°	-40° to 105°
*Chemical resistant material not available for PCB guide housings		
Mating Cycles No Load by Plating	Silver (Ag)	Tin (Sn)
Wire and PCB Contacts	10,000	1,500
Avg. Mating / Unmating Force	Lbf.	N
Wire to Wire Low Force Contacts	10	44
Wire to Wire High Force Contacts	15	67
Standard Powerclaw to Wire	15	66
Mini Powerclaw to Wire	8	36
PCB Specifications		
Mounting Style	Plated Through Hole	
Max PCB Thickness- in. [mm]	Standard: 0.15 [0.381]	
	Mini: 0.25 [0.635]	
Recommended Traces	#8 AWG Cross Section	
Min. Contact / Spring Retention Force	Lbf.	N
Wire Housing	50	222
Min. Creepage / [Clearance] Distance	in.	mm
Standard Powerclaw	0.374	9.5
Mini Vert. Powerclaw	0.213	5.4
Mini Horiz. Powerclaw	0.205	5.2
Mechanical Shock ⁴		
MIL-STD-202	213 Condition A	50g's
Vibration High Frequency ⁴		
MIL-STD-202	204 Condition A	10g's

NOTE 1: See IEC 60664-1 for working voltage.

NOTE 2: Amp ratings are stated per position and based on all positions being fully loaded.

¹ Based on: 105°C rated or better cable of the largest size, Properly calibrated APP recommended tooling, and a 25°C ambient temperature. UL rating not to exceed the maximum operating temperature. CSA rating below a 30°C temperature rise.

² Limited by the thermal properties of the connector plastic housing.

³ Use APP recommended tooling only. Alternate tools may adversely affect the performance of our connectors along with UL and CSA recognition.

⁴ Tested with contact part number 5900.



| IEC INFORMATION |

Connector Series	Configurations	Creepage/Clearance per IEC 60950-1	Material Group
SB@50	Unmated	2.99 mm	Illa
	Mated	2.99 mm	

Attributes	SB50
AMP Rating AC/DC	50
Voltage Rating AC/DC (Steady State)	250
Breaking Capacity -AMP Rating /Cycles	50 / 10 Cycles
Voltage Rating (Breaking Capacity)	220 VDC
Finger Safety - Mated only	IEC 60529 - IP20
Wire Size tested	16 mm ²
Contact Series Tested	5900/1307
Climatic Testing (Cold,Heat & MFG)	IEC 60512 Test -11j, 11i & 11g,
Cycle Life	IEC 60512 Test 9a - 5000 Cycles
Mechanical Strength Impact	IEC 60512-5 @ 29.5 Inches - dropped 8 times
Temperature Range	-20 °C to 105 °C -4 °F to 221 °F

Protection

Touch Safety with Wire Contacts	
IEC 60529	IP10
Environmental Sealing with Boots	
IEC 60529	IP64

NOTE 3: Refer to the Constructional Data form for additional information on our website., www.andersonpower.com



SB®50 CONNECTOR TEMPERATURE CHARTS

Temperature rise charts are based on a 25°C ambient temperature.

For Temperature Rise Above 60°C, Consult the Extended Temperature Rise Charts in the Appropriate Product Section on the Website.

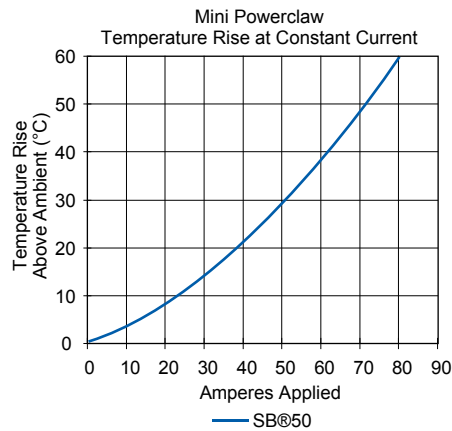
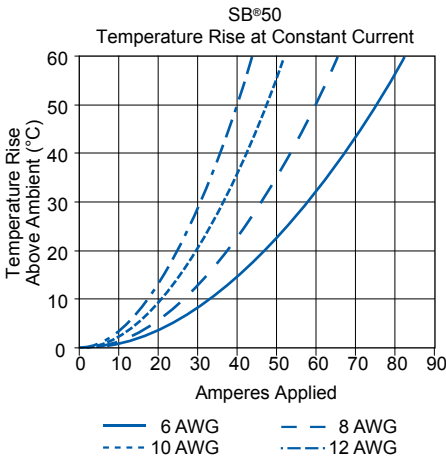

Current - Temperature Derating per IEC 60512-5-2 Test 5B

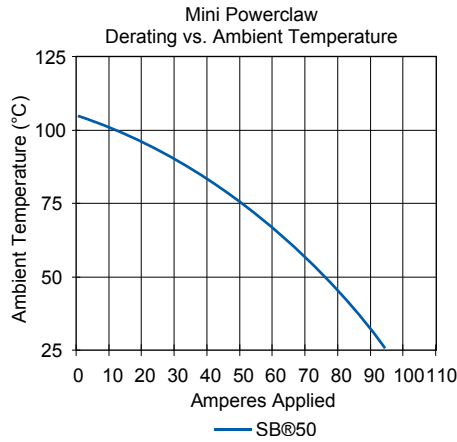
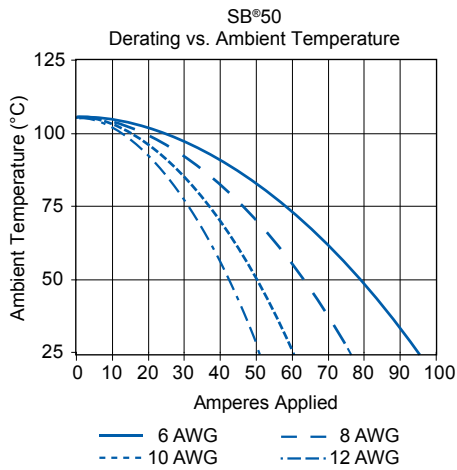

NOTE: Powerclaw charts are based on #8 AWG equivalent copper foil on board side, mated to #6 AWG conductor on wire side.

SECTION 3
SB®50

SB® Accessories

"T" Handle

The "T" handle makes mating and unmating the connector easier. The non-conductive red plastic material is strong and safe. (2) Self tapping screws are used to secure the handle to the connector housing.

Description	----- Part Numbers -----	
Minimum Quantity	1,000	50
Red "T" Handle + Hardware Bag	-	SB50-HDL-RED
Hardware Bag (2 Screws)	-	104G17
Red "T" Handle Only	113899P1	-
#8 x 5/8" Screw (Order 2 Per Handle)	H1120P55	-

"A" frame handle for SB®50

Handle makes mating and unmating the connector easier. The non-conductive gray plastic material is strong and safe. Machine screws and locknuts included.

Description	- Part Number -
Minimum Quantity	200
Gray "A" Handle & Hardware	997G1

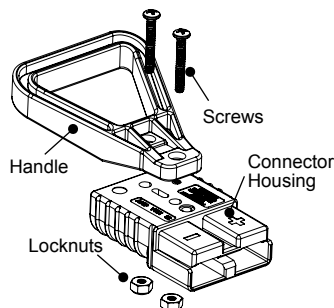
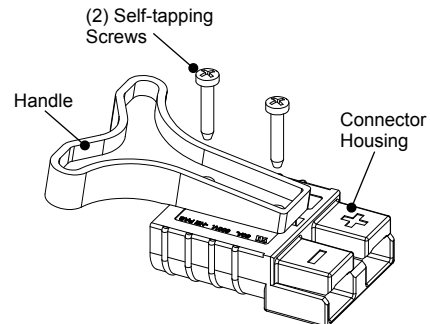

Dust Cover

Prevents dust and dirt from entering the mating interface of the connector when unmated. NOTE: Not a Hermetic Seal.

Description	----- Part Numbers -----	
Minimum Quantity	500	50 ...
Dust Cover with Lanyard Strap, Red	113890P1	134G1

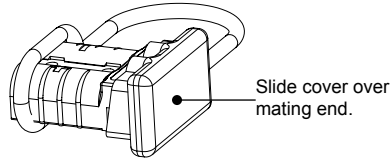

SB® Environmental Boots

SB® Environmental Boots provide water, dirt, chemical and UV protection for SB®50 connectors. The durable boots shield the connectors from water and dirt to IP64 in both the mated and unmated condition.

Description	----- Part Numbers -----	
Minimum Quantity	250	25 ...
SB®50 Environmental Boot with Cover, Load	3-6054P2-BK	3-6054P2
SB®50 Environmental Boot with Cover, Source	3-6055P2-BK	3-6055P2
SB®50 Environmental Boot (no cover), Load	3-6054P1-BK	3-6054P1
SB®50 Environmental Boot (no cover), Source	3-6055P1-BK	3-6055P1

Dimensions					
- A -		- B -		- C -	
in	mm	in	mm	in	mm
5.9	151.4	1.8	45.1	6.3	160

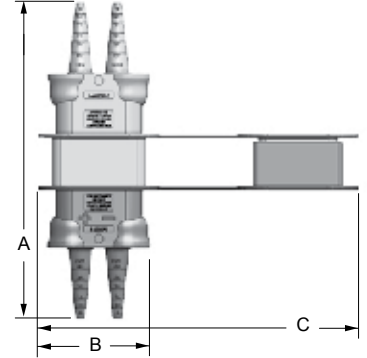

Guide Housings for Vertical Mini Powerclaw Contacts

Prevents polarity being reversed when a SB®50 is mated to vertical mini Powerclaw contacts.

Description	----- Part Numbers -----	
Minimum Quantity ...	1,000	50
Black Guide Housing	PC-HSG-SB-BK	PC-HSG-SB

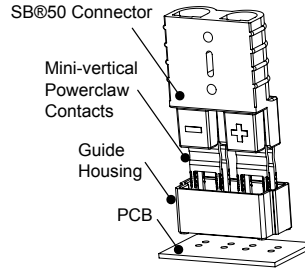

Cable Clamps

Durable metal cable clamps securely hold cables to prevent accidental strain or pulls from dislodging wire or contacts from the housing. Cable clamps are recommended for solder terminated wires.

Description	Cable Size		----- Part Numbers -----	
	AWG or (Inches O.D.)	mm² or (mm O.D.)		
Minimum Quantity			500	50 ...
Self Attaching for Discrete Conductor	8 to 6	10	990-BK	990
Self Attaching for Discrete Conductor	12 to 10	4 to 6	990G2-BK	990G2
Bolt on for Discrete Conductor	12 to 6	4 to 10	990G1-BK	990G1
Bolt on for Bundled Conductor	(0.320 to 0.450)	(4.27 to 11.43)	5905-BK	5905

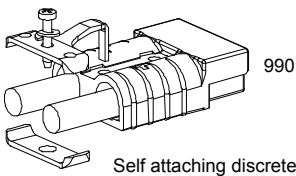

Self attaching discrete conductor.

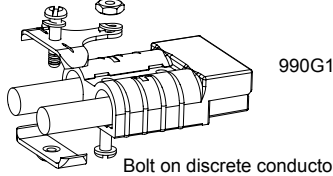

Bolt on discrete conductor.

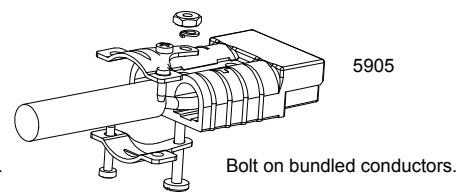

Bolt on bundled conductors.

The given wire O.D. information is an estimate. Cable clamps should be evaluated for performance with the actual wire to be used.

Reducing Bushings

Use with contact part number 5900-BK or 1307-BK to allow a smaller wire to be used with the connector. Electrical capability is derated with smaller wire.

Contact Barrel Size	Wire Size	----- Part Numbers -----			Dimensions			
					- ID -	- Length -		
					inches	mm	inches	mm
Minimum Quantity		3,000	1,000	100				
#6 AWG [13.3 mm²]	#8 AWG [8.4 mm²]	-	5912-BK	5912	0.18	4.57	0.45	11.43
#6 AWG [13.3 mm²]	#12- 10 AWG [3.3- 5.3 mm²]	5910-BK	-	5910	0.14	3.56	0.47	11.94
#6 AWG [13.3 mm²]	#16- 14 AWG [1.3- 2.1 mm²]	5913-BK	-	5913	0.09	2.29	0.47	11.94

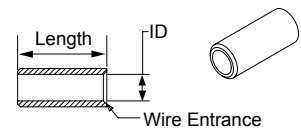

SB®120 Connectors

- up to 240 Amps

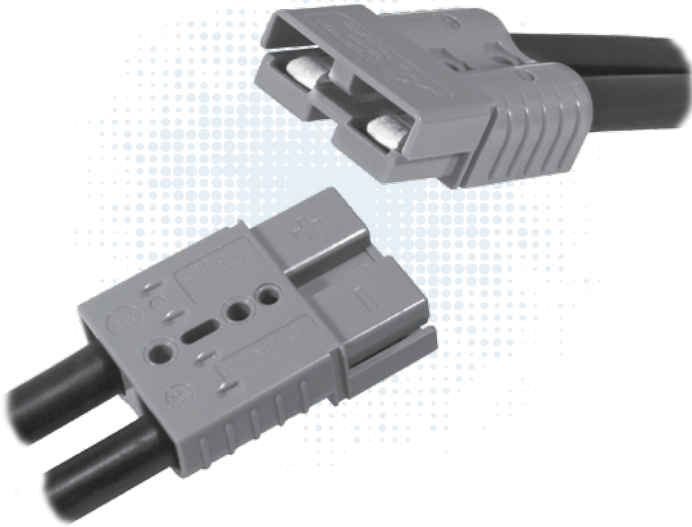

Like the other Multipole connectors, the SB®120 offers color-coded mechanically keyed housings. Keys can be used to identify and separate different circuits, or prevent users from accidentally cross mating different voltages. Wires sizes from #10 (5.3 mm²) to #1 (42.4 mm²) are held in the second smallest SB® housing.

- **New extended range contacts expand wire size up to #1 AWG (42.4 mm²)**
Allows UL rated currents up to 240 amps
- **Chemical resistant housing option**
Extends temperature range down to -40°C, while offering enhanced UV and chemical resistance
- **Panel mounting grooves**
With use of mounting clamps, can be easily mounted through panels

SECTION 3
SB® 120

| SB®120 ORDERING INFORMATION |

SB®120 Standard Housings

The second to smallest SB® housings work with wire contacts up to 1 AWG [35 mm²] as well as busbar contacts. Genderless design mates with itself. Mechanical keys are color coded.

Description	----- Part Numbers -----	
Minimum Quantity	250	50
Red	6810G3-BK	6810G3
Gray	6810G1-BK	6810G1
Blue	6810G2-BK	6810G2

SB®120 Chemical Resistant (CR) Housings

Same features as the Standard SB®120 but molded in a chemical resistant PBT/ PC blend. Suitable for use to -40°C.

Description	----- Part Numbers -----	
Minimum Quantity	250	50
Red	P6810G3-BK	P6810G3
Gray	P6810G1-BK	P6810G1

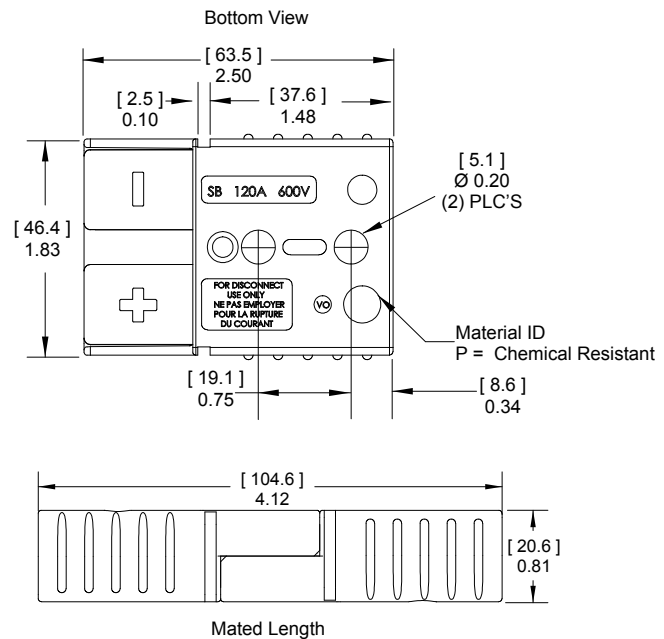

SB®120 Silver Plated Wire Contacts

Silver plated contacts offer superior electrical performance and durability up to 10,000 mating cycles. See reducing bushings in accessory section for smaller wires.

AWG	mm ²	Mating Force	----- Loose Piece Part Numbers -----			Dimensions			
						- A -		- B -	
Minimum Quantity			600	500	50	inches	mm	inches	mm
1	42.4	Low	1323G1-BK	-	1323G1	0.47	11.94	0.39	9.91
2	33.6	High	-	1319-BK	1319	0.44	11.18	0.34	8.64
4	21.1	High	-	1319G4-BK	1319G4	0.44	11.18	0.29	7.37
6	13.3	High	-	1319G6-BK	1319G6	0.44	11.18	0.22	5.59

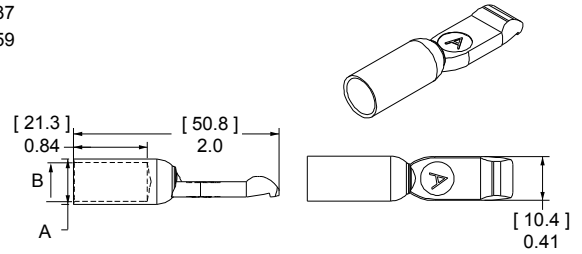

SB®120 Silver Plated Busbar Contacts

Use 2 busbar contacts per housing to provide a quick disconnect input or output busbar connection. Busbar contacts are for mating with wire contacts only. Part number 120BBS includes lock nuts. Locknuts must be ordered separately for B01997P1.

Type	Thread	Mating Force	----- Loose Piece Part Numbers -----			
Minimum Quantity			1,000	300	20	10 ...
Busbar	#10-24	High	-	B01997P1	-	120BBS
Lock Nut	#10-24	-	H1216P8	-	110G54	-

See Busbar contact drawing on website for further detail.

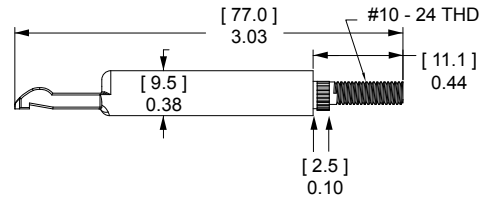

| SB®120 CONNECTOR SPECIFICATIONS |

Electrical		
Current Rating Amperes ¹	UL 1977	CSA
Wire to Wire (1 AWG)	240	130
Wire to Busbar (2 AWG)	120	
Voltage Rating AC/DC		
UL 1977	600	
Dielectric Withstanding Voltage		
Volts AC	2,200	
Avg. Mated Contact Resistance Milliohms ¹		
5 1/2" of #2 AWG wire	0.136	
Hot Plug Current Rating Amperes - Wire & Busbar		
250 cycles at 120V DC	60A	

Mechanical		
Wire Size Range	AWG	mm²
Wire Contacts with Bushings	10 - 1	5.3 - 42.4
Max. Wire Insulation Diameter	in.	mm
	0.600	15.240
Operating Temperature ²	°F	°C
Standard	-4° to 221°	-20° to 105°
Chemical Resistant*	-40 to 221°	-40° to 105°
Mating Cycles No Load by Plating	Silver (Ag)	
Wire and Busbar Contacts	10,000	
Avg. Mating / Unmating Force	Lbf.	N
Wire to Wire	20	89
Min. Contact / Spring Retention Force		
lbf	75	
N	333.6	

Materials	
Housing	
Standard Plastic Resin	Polycarbonate
Chem. Resistant Resin	Polycarbonate / PBT blend
Contact Retention Spring	Stainless Steel
Housing Flammability Rating	
UL94	V-0
Glow Wire	960°C (GWFI) / 800°C (GWIT)
Wire & Busbar Contacts	
Base	Copper Alloy
Plating	Silver
Contact Termination Methods	
Crimp ³	Wire Contacts
Hand Solder	Wire Contacts
Wrench / Socket	Busbar Contacts Only

NOTE 1: See IEC 60664-1 for working voltage.

NOTE 2: Amp ratings are stated per position and based on all positions being fully loaded.

¹ Based on: 105°C rated or better cable of the largest size, Properly calibrated APP recommended tooling, and a 25°C ambient temperature. UL rating not to exceed the maximum operating temperature. CSA rating below a 30°C temperature rise.

² Limited by the thermal properties of the connector plastic housing.

³ Use APP recommended tooling only. Alternate tools may adversely affect the performance of our connectors along with UL and CSA recognition.



SECTION 3
SB® 120

| IEC INFORMATION |

Connector Series	Configurations	Creepage/Clearance per IEC 60950-1	Material Group
SB@120	Unmated	4.10 mm	IIIa
	Mated	4.10 mm	

Attributes	SB120
AMP Rating AC/DC	120
Voltage Rating AC/DC (Steady State)	400 V AC/DC (Operational)
Breaking Capacity -AMP Rating /Cycles	120 Amp/ 10 Cycles
Voltage Rating (Breaking Capacity)	220 VDC
Finger Safety - Mated only	IEC 60529 - IP20
Wire Size tested	50 mm ²
Contact Series Tested	1323
Climatic Testing (Cold,Heat & MFG)	IEC 60512 Test -11j, 11i & 11g,
Cycle Life	IEC 60512 Test 9a - 5000 Cycles
Mechanical Strength Impact	IEC 60512-5 @ 29.5 Inches - dropped 8 times
Temperature Range	-20 °C to 105 °C -4 °F to 221 °F

Protection	
Touch Safety with Wire Contacts	
IEC 60529	IP10
Environmental Sealing with Boots	
IEC 60529	IP64

NOTE 3: Refer to the Constructional Data form for additional information on our website., www.andersonpower.com



| SB®120 CONNECTOR TEMPERATURE CHARTS | Temperature rise charts are based on a 25°C ambient temperature.

For Temperature Rise Above 60°C, Consult the Extended Temperature Rise Charts in the Appropriate Product Section on the Website.

Current - Temperature Derating per IEC 60512-5-2 Test 5B

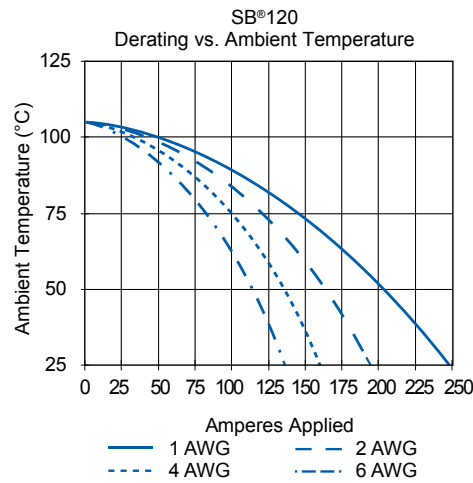
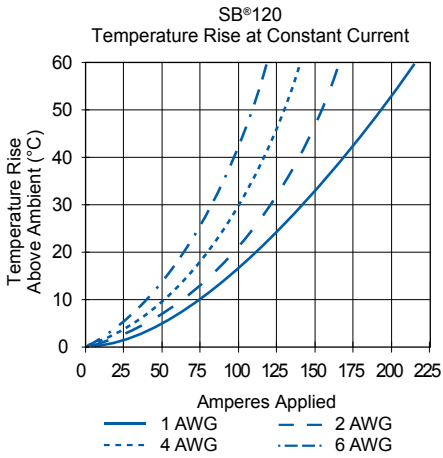

| SB® 120 ACCESSORIES |

Mounting Clamp for SB®120

Mounting clamps can be used for fastening a SB®120 series housings to a panel. Fastening hardware not included.

Description	--- Part Number ---
Minimum Quantity	20 sets of 2
Panel Mount Bracket	1467G1

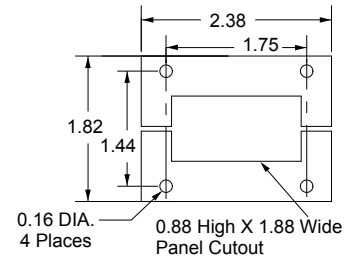

Cable Clamps

Durable metal cable clamps securely hold cables to prevent accidental strain or pulls from dislodging wire or contacts from the housing. Cable clamps are recommended for solder terminated wires.

Description	Cable Size		- Part Numbers -
	Min / Max Inches O.D.	Min / Max mm O.D.	
Minimum Quantity			50
Bolt on for Discrete Conductor	0.70 to 0.23	17.7 to 5.8	981G1
Bolt on for Bundled Conductor	0.73 to 0.29	18.5 to 7.3	981G2

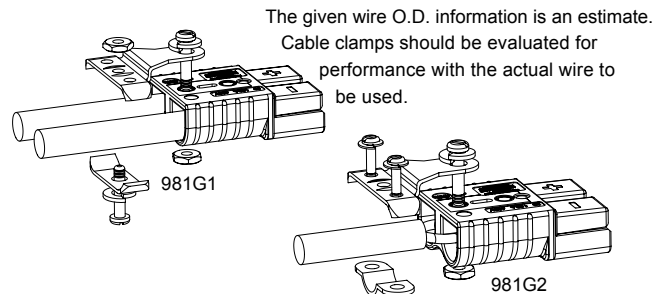

SECTION 3
SB® 120

“A” Frame Handle for SB®120

Handle makes mating and unmating the connector easier. The non-conductive gray plastic material is strong and safe. Machine screws and locknuts included.

Description	- Part Number -	
Minimum Quantity	200
Gray “A” Handle & Hardware	997G1	

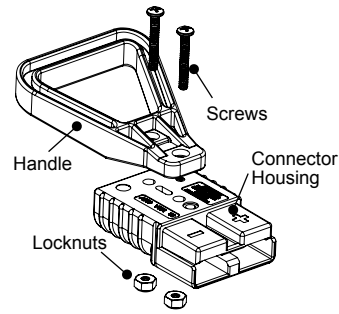

“T” Handle

The “T” handle makes mating and unmating the connector easier. The non-conductive red plastic material is strong and safe. (2) Self tapping screws are used to secure the handle to the connector housing.

Description	----- Part Numbers -----	
Minimum Quantity	1,000	50
Red “T” Handle + Hardware Bag	-	SB120-HDL-RED
Red “T” Handle Only	113899P1	-
#8 x 7/8” Screw (Order 2 Per Handle)	H1120P43	-

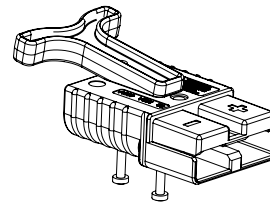

Dust Cover

Prevents dust and dirt from entering the mating interface of the connector when unmated. NOTE: Not a Hermetic Seal.

Description	----- Part Numbers -----	
Minimum Quantity	100	50
Dust Cover with Lanyard Strap, Black	B02019P1	134G4

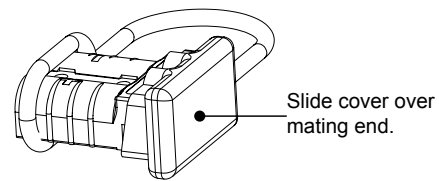

SB® Environmental Boots

SB® Environmental Boots provide water, dirt, chemical and UV protection for SB®120 connectors. The durable boots shield the connectors from water and dirt to IP64 in both the mated and unmated condition.

Description	----- Part Number -----	
Minimum Quantity	250	25 ...
SB®120 Environmental Boot, Load	3-6035P1-BK	3-6035P1
SB®120 Environmental Boot, Source	3-6034P1-BK	3-6034P1

Dimensions		
- A -	- B -	- C -
in mm	in mm	in mm
7.9 201	2.8 71	8.0 203

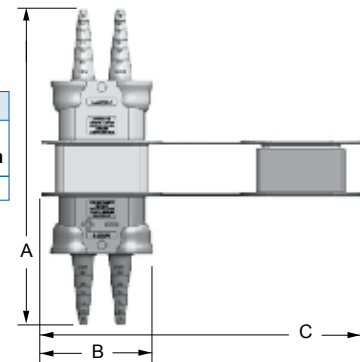

Reducing Bushings

Use with contact part number 1319-BK to allow a smaller wire to be used with the connector. Electrical capability is derated with smaller wire.

Contact Barrel Size	Wire Size	----- Part Numbers -----			Dimensions - ID -	
					inches	mm
Minimum Quantity		2,000	1,000	100		
#2 AWG [33.6 mm ²]	#4 AWG [21.2 mm ²]	5919-BK	-	5919	0.28	7.11
#2 AWG [33.6 mm ²]	#6 AWG [16 mm ²]	-	5920-BK	5920	0.23	5.84
#2 AWG [33.6 mm ²]	#10 - 8 AWG [5.3 - 8.4 mm ²]	5921-BK		5921	0.18	4.57

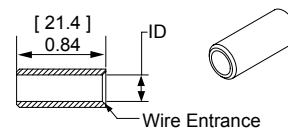

SB®175 Connectors - up to 280 Amps

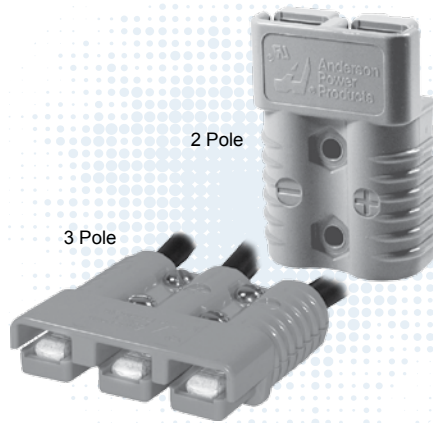

Wires sizes from #10 (5.3 mm²) to 1/0 (50 mm²) fit in the second to largest connector in the SB® series. The 3 pole SB®175 adds an additional position for power or grounding. All Multipole wire connector housings are genderless and mate to themselves minimizing inventory and assembly complexity.

- **Silver Plated Wire Contacts up to 1/0 (50 mm²)**
Allows UL rated currents up to 280 amps
- **Chemical Resistant Housing Option**
Extends temperature range down to -40°C, while offering enhanced UV and chemical resistance
- **UL Rated for Hot Plugging up to 100 Amps**
Great for battery or other applications where the ability to interrupt circuits is required

| SB®175 ORDERING INFORMATION |

SB®175 Standard Housings

The second to largest SB® housings work with wire contacts up to 1/0 AWG [50 mm²] as well as busbar contacts. Genderless design mates with itself. Mechanical keys are color coded. NOTE: SB®175 black housing is keyless and can be mated with all other colors.

Description	--- Part Numbers ---	
Minimum Quantity	200	50 ...
Yellow	943-BK	943
Orange	942-BK	942
Red	949-BK	949
Gray	940-BK	940
Blue	941-BK	941
Black (Keyless)	2-7252G11	-

SB®175 Chemical Resistant Housings

Same features as the Standard SB®175 but molded in a chemical resistant PBT/ PC blend. Suitable for use to -40°C.

Description	--- Part Numbers ---	
Minimum Quantity	200	50 ...
Red	P949-BK	P949
Gray	P940-BK	P940

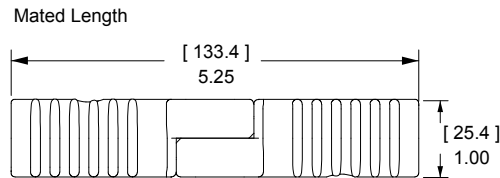
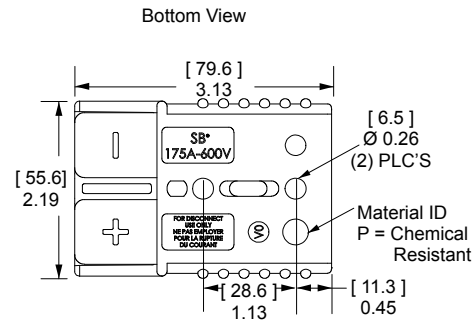

SB®175 3 Pole Housings & Hardware

A three pole version of the standard SB®175 housing has a two piece housing with springs and hardware. Useful for DC 2 wire plus ground and AC single phase applications.

Description	--- Part Numbers ---	
Minimum Quantity	100	25
Gray Housing and Hardware Kit	-	902
Gray Housing Top Half	2-5048	-
Gray Housing Bottom Half	2-5049	-
Hardware Kit	-	110G34

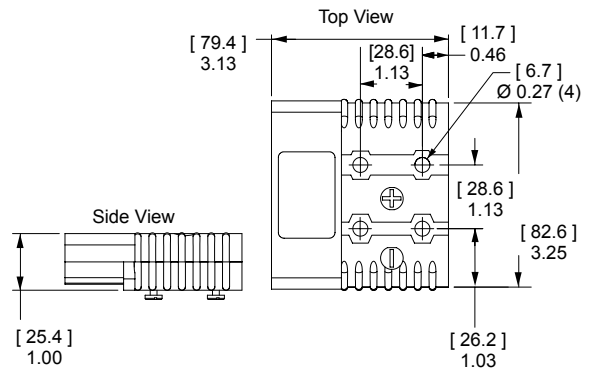

SB®175 Silver Plated Wire Contacts

Silver plated contacts offer superior electrical performance and durability up to 10,000 mating cycles. See reducing bushings in accessory section for smaller wires.

AWG	mm ²	Mating Force	Loose Piece - Part Numbers -		Dimensions							
					- A -		- B -		- C -		- D -	
Minimum Quantity			500	50	inches	mm	inches	mm	inches	mm	inches	mm
1/0	53.5	High	1382-BK	1382	2.35	59.69	0.52	13.21	0.44	11.18	1.04	26.42
1	42.4	High	1347-BK	1347	2.35	59.69	0.52	13.21	0.39	9.91	1.04	26.42
2	33.6	High	1383-BK	1383	2.35	59.69	0.52	13.21	0.35	8.89	1.04	26.42
4	21.1	High	1384-BK	1384	2.35	59.69	0.52	13.21	0.30	7.62	1.04	26.42
6	13.3	High	1348-BK	1348	2.10	53.34	0.37	9.40	0.22	5.59	0.80	20.32

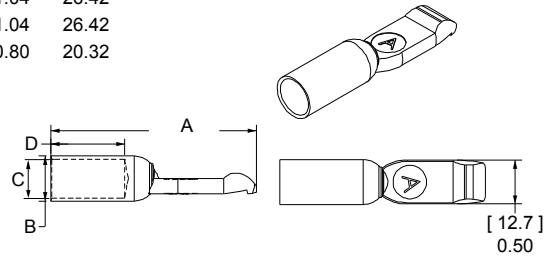

SB®175 Silver Plated Busbar Contacts

Provides a quick disconnect input or output busbar connection. Busbar contacts are for mating with wire contacts only. Part number 180BBS includes lock nuts. Locknuts must be ordered separately for 180BBS-BK.

Type	Thread	Mating Force	----- Loose Piece Part Numbers -----		
Minimum Quantity			1,000	120	10
Busbar	1/4-20	High	-	180BBS-BK	180BBS
Lock Nut	1/4-20	-	H1216P7	110G56	110G55

See Busbar contact drawing on website for further detail.

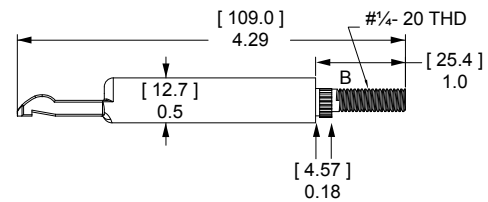

SB®175 CONNECTOR SPECIFICATIONS |

Electrical		
Current Rating Amperes ¹	UL 1977	CSA
Wire to Wire (1/0 AWG)	280	175
Wire to Busbar (1/0 AWG)	200	
3 Pole Wire to Wire (1/0 AWG)	175	
Voltage Rating AC/DC		
UL 1977	600	
Dielectric Withstanding Voltage		
Volts AC	2,200	
Avg. Mated Contact Resistance Milliohms ¹		
6" of 1/0 AWG wire	0.100	
UL Hot Plug Current Rating Amperes - Wire & Busbar		
250 cycles at 120V DC 1/0 wire	100A	

Materials	
Housing	
Standard Plastic Resin	Polycarbonate
Chem. Resistant Resin	Polycarbonate / PBT blend
Contact Retention Spring	Stainless Steel
Housing Flammability Rating	
UL94	V-0
Glow Wire	960°C (GWFI) / 850°C (GWIT)
Wire & Busbar Contacts	
Base	Copper Alloy
Plating	Silver
Contact Termination Methods	
Crimp ³	Wire Contacts
Hand Solder	Wire Contacts
Wrench / Socket	Busbar Contacts

Mechanical		
Wire Size Range	AWG	mm²
Wire Contacts with Bushings	10 to 1/0	5.3 to 53.5
Max. Wire Insulation Diameter	in.	mm
	0.600	15.240
Operating Temperature ²	°F	°C
Standard	-4° to 221°	-20° to 105°
Chemical Resistant*	-40 to 221°	-40° to 105°
Mating Cycles No Load by Plating	Silver (Ag)	
Wire and Busbar Contacts	10,000	
Avg. Mating / Unmating Force	Lbf.	N
2 Pole	25	111
3 Pole	35	156
Min. Contact / Spring Retention Force		
lbf	150	
N	667	
Mechanical Shock ⁴		
MIL-STD-202	213 Condition A	50g's
Vibration High Frequency ⁴		
MIL-STD-202	204 Condition A	10g's

NOTE 1: See IEC 60664-1 for working voltage.

NOTE 2: Amp ratings are stated per position and based on all positions being fully loaded.

¹ Based on: 105°C rated or better cable of the largest size, Properly calibrated APP recommended tooling, and a 25°C ambient temperature. UL rating not to exceed the maximum operating temperature. CSA rating below a 30°C temperature rise.

² Limited by the thermal properties of the connector plastic housing.

³ Use APP recommended tooling only. Alternate tools may adversely affect the performance of our connectors along with UL and CSA recognition.

⁴ Tested with contact part number 1382.



IEC INFORMATION |

Connector Series	Configurations	Creepage/Clearance per IEC 60950-1	Material Group
SB®175	Unmated	5.73 mm	IIla
	Mated	5.73 mm	

Attributes	SB175
AMP Rating AC/DC	175
Voltage Rating AC/DC (Steady State)	500 V AC/DC (Operational)
Breaking Capacity - AMP Rating /Cycles	175 Amp / 10 Cycles
Voltage Rating (Breaking Capacity)	220 VDC
Finger Safety - Mated Only	IEC 60529 - IP20
Wire Size Tested	50 mm ²
Contact Series Tested	1382
Climatic Testing (Cold, Heat & MFG)	IEC 60512 Test -11j, 11i & 11g,
Cycle Life	IEC 60512 Test 9a - 5000 Cycles
Mechanical Strength Impact	IEC 60512-5 @ 29.5 Inches - dropped 8 times
Temperature Range	-20 °C to 105 °C -4 °F to 221 °F

Protection	
Touch Safety with Wire Contacts	
IEC 60529	IP10
Environmental Sealing with Boots	
IEC 60529	IP64

NOTE 3: Refer to the Constructional Data form for additional information on our website., www.andersonpower.com



SB®175 CONNECTOR TEMPERATURE CHARTS | Temperature rise charts are based on a 25°C ambient temperature.

For Temperature Rise Above 60°C, Consult the Extended Temperature Rise Charts in the Appropriate Product Section on the Website.

Current - Temperature Derating per IEC 60512-5-2 Test 5B

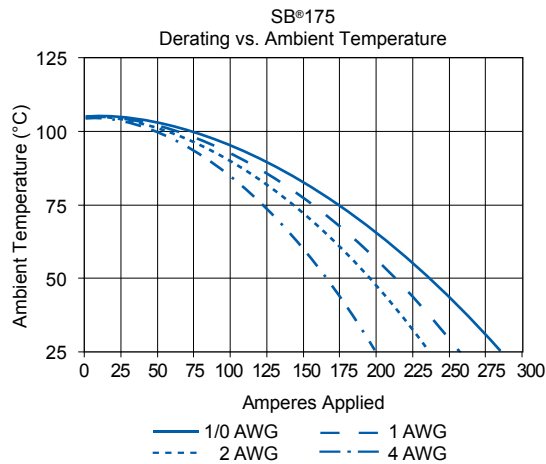
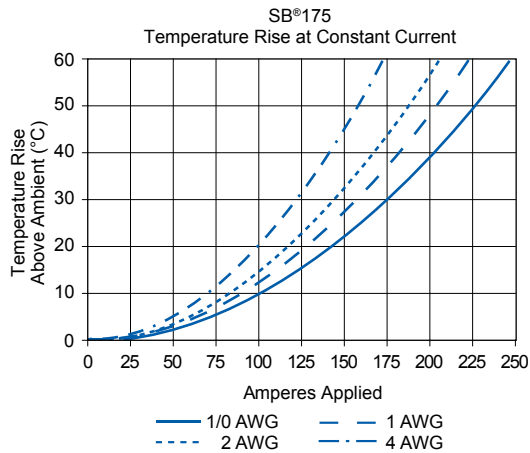

SB® 175 ACCESSORIES |

Cable Clamps

Durable metal cable clamps securely hold cables to prevent accidental strain or pulls from dislodging wire or contacts from the housing. Only Bolt On type clamps can be used with the handles. Cable clamps are recommended for solder terminated wires. Not for use with 3 pole housing.

Description	Cable Size		Part Numbers	
	Max / Min In. Inches O.D.	Max / Min mm mm O.D.	100	50
Minimum Quantity			100	50
Self Attaching for Discrete Conductor	0.55 to 0.24	14 to 6	105G3	945
Bolt On for Discrete Conductor	0.66 to 0.24	16.7 to 6.2	945G3-BK	945G3
Bolt On for Bundled Conductor	0.75 to 0.29	18.3 to 7.3	946G1-BK	946G1

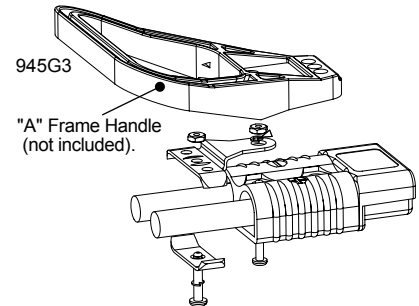
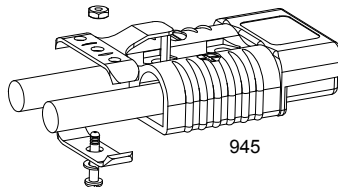
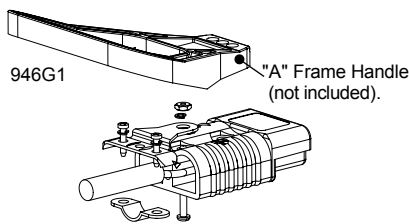

The given wire O.D. information is an estimate. Cable clamps should be evaluated for performance with the actual wire to be used.

Handles

Handles are made out of durable PC plastic. Hardware to attach to connector body included in kits. Not for use with 3 pole housing.

Description	Part Numbers	
Minimum Quantity	100	25
Gray Handle Kit	-	995G1
Red Handle Kit	-	995G3
Handle Only, Gray	3-5074P1	-
Handle Only, Red	3-5074P3	-
Handle Only, Black	3-5074P5	-
Hardware Bag	-	105G8

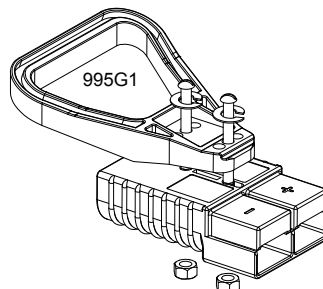

Dust Cover

Prevents dust and dirt from entering the mating interface of the connector when unmated. NOTE: Not a Hermetic Seal. Not for use with 3 pole housing.

Description	----- Part Numbers -----	
Minimum Quantity	500	50 ...
Dust Cover with Lanyard Strap, Red	113890P2	134G2

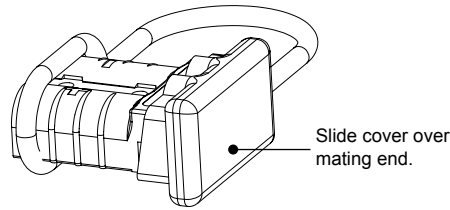

SB® Environmental Boots

SB® Environmental Boots provide water, dirt, chemical and UV protection for SB® 175 connectors. The durable boots shield the connectors from water and dirt to IP64* in both the mated and unmated condition.

Description	----- Part Number -----	
Minimum Quantity	250	25 ...
SB® 175 Environmental Boot, Load	3-6037P1-BK	3-6037P1
SB® 175 Environmental Boot, Source	3-6036P1-BK	3-6036P1

Dimensions		
- A -	- B -	- C -
in mm	in mm	in mm
9.5 241	3.2 80	9.3 236

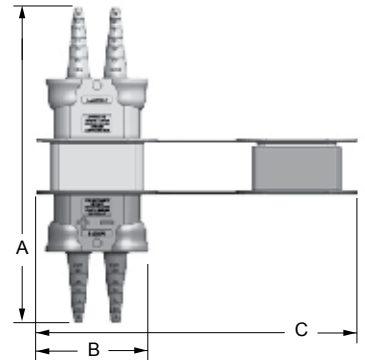

*IP64 test pending

SB®175 Lockout

Works with standard lockout - tagout equipment to prevent access to the mating interface of the connector. Made from durable PC plastic. Can be used with 3 pole housing to lockout positive and negative positions only.

Description	----- Part Number -----	
Minimum Quantity	25	...
Red Lockout - Tagout Kit	SB175-LOCKOUT	

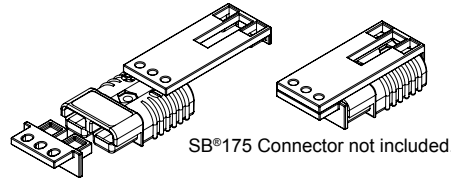

Manual Release Bracket - Mounting Side

Works with the Locking Side to ease mating and unmating connectors. Not for use with 3 pole housing.

Description	- Part Number -	
Minimum Quantity	10	...
Bracket and Hardware Kit	924G1	

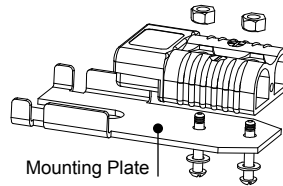

Manual Release Bracket - Locking Side

Works with the Mounting Side to ease mating and unmating connectors. Not for use with 3 pole housing.

Description	Cable Size		- Part Number -
	Max / Min Inches O.D.	Max / Min mm O.D.	
Minimum Quantity			10 ...
Bracket and Hardware Kit w/ Clamp	0.50 to 0.21	12.6 to 5.4	923G1

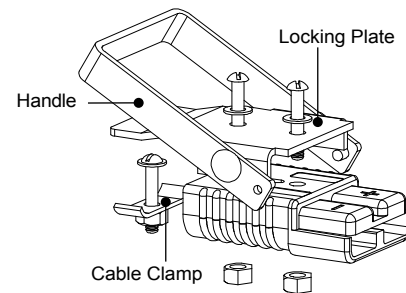

The given wire O.D. information is an estimate. Cable clamps should be evaluated for performance with the actual wire to be used.

Reducing Bushings: for Use with Contact # 1382

Use with contact part number 1382-BK to allow a smaller wire to be used with the connector. Electrical capability is derated with smaller wire.

Contact Barrel Size	Wire Size	----- Part Numbers -----				Dimensions - ID -	
		1,500	1,000	500	100	inches	mm
Minimum Quantity							
1/0 AWG [53.5 mm ²]	#1 AWG [42.4 mm ²]	-	-	5687-BK	5687	0.39	9.91
1/0 AWG [53.5 mm ²]	#2 AWG [33.6 mm ²]	5690-BK	-	-	5690	0.34	8.64
1/0 AWG [53.5 mm ²]	#4 AWG [21.2 mm ²]	-	5693-BK	-	5693	0.27	6.86
1/0 AWG [53.5 mm ²]	#6 AWG [13.3 mm ²]	-	5663-BK	-	5663	0.22	5.59
1/0 AWG [53.5 mm ²]	#10 - 8 AWG [5.3 - 8.4 mm ²]	5648-BK	-	-	5648	0.19	4.83

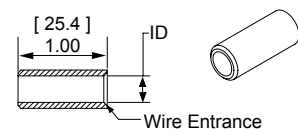

SB[®]350 Connectors - up to 500 Amps



The SB[®]350 is the largest connector in the series with power capabilities up to 450 amps with 4/0 AWG wire and 500 amps with a 350 mcm wire. Wires ranging from #1/0 (53.5 mm²) to 350 mcm (150 mm²) fit into the one piece housing available in standard PC or a chemical resistant PBT/PC blend. Silver plated wire or busbar contacts minimize electrical resistance while offering supreme durability and reliability.

- **Up to 350 mcm (150 mm²) Wires**
Allows UL rated currents up to 500 amps
- **Chemical Resistant Housing Option**
Extends temperature range down to -40°C, while offering enhanced UV and chemical resistance
- **Same Housings Used for Wire and Busbar Contacts**
Enables color-coded mechanically keyed wire to busbar connections

| SB[®]350 ORDERING INFORMATION |

SB[®]350 Standard Housings

The largest SB[®] housings work with wire contacts up to 350 mcm [150 mm²] as well as busbar contacts. GerBottom View derless design mates with itself. Mechanical keys are color coded. NOTE: SB[®]350 Black and Blue Housings have the same keying features and can be intermated.

Description	--- Part Numbers ---	
Minimum Quantity	50	25 ...
Yellow	914-BK	914
Orange	932-BK	932
Red	913-BK	913
Gray	906-BK	906
Blue	912-BK	912
Green	931-BK	931
Black	2-7250G8	-

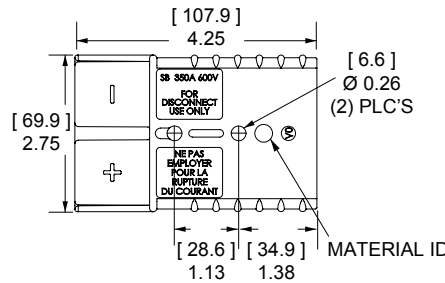

P = Chemical Resistant

SB[®]350 Chemical Resistant Housings

Same features as the Standard SB[®]350 but molded in a chemical resistant PBT/ PC blend. Suitable for use to -40°C.

Description	--- Part Numbers ---	
Minimum Quantity	50	25
Red	P913-BK	P913
Gray	P906-BK	P906

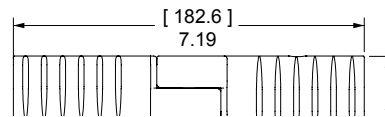

Mated Length

SB[®]350 Silver Plated Wire Contacts

Silver plated contacts offer superior electrical performance and durability up to 10,000 mating cycles. See reducing bushings in accessory section for smaller wires.

AWG	mm ²	Mating Force	Dimensions								
			- A -	- B -	- C -						
Minimum Quantity			200	150	50						
300mcm	152	High	-	910-BK	910 *	0.75	19.05	0.87	22.10	3.04	77.2
4/0	107.2	High	908-BK	-	908 *	0.64	16.26	0.75	19.05	3.03	77.0
3/0	85	High	916-BK	-	916 *	0.58	14.73	0.70	17.78	3.00	76.2
2/0	67.4	High	907-BK	-	907 *	0.49	12.45	0.64	16.26	2.96	75.2
1/0	53.5	High	917-BK	-	917 *	0.44	11.18	0.51	12.95	2.91	73.9

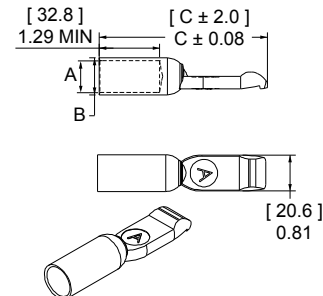

* Sold as pairs. 2 parts shipped for every 1 part ordered.

SB®350 Silver Plated Busbar Contacts

Use 2 busbar contacts per housing to provide a quick disconnect input or output busbar connection. Busbar contacts are for mating with wire contacts only. Part number 350BBS includes lock nuts. Locknuts must be ordered separately for B01998P1.

Type	Thread	Mating Force	- Loose Piece Part Numbers -	
Minimum Quantity			50	10
Busbar	3/8-16	High	B01998P1	350BBS
Lock Nut	3/8-16	-	H1216P9	110G73

NOTE: Has not been tested by UL.

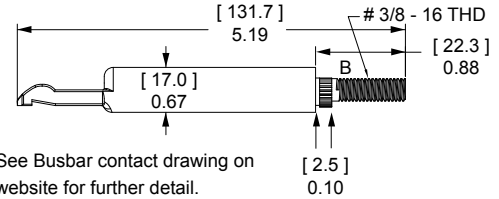

| SB®350 CONNECTOR SPECIFICATIONS |

Electrical		
Current Rating Amperes ¹	UL 1977	CSA
Wire to Wire (4/0 AWG)	450	
Wire to Wire (350 mcm)	500	325
Voltage Rating AC/DC		
UL 1977	600	
Dielectric Withstanding Voltage		
Volts AC	2,200	
Avg. Mated Contact Resistance Milliohms ¹		
2 1/2" of 300mcm wire	0.050	
Hot Plug Current Rating Amperes - Wire & Busbar		
250 cycles at 120V DC	100A	

Mechanical		
Wire Size Range	AWG	mm²
Wire Contacts with Bushings	1/0 to 350 mcm	53.5 to 150
Max. Wire Insulation Diameter	in.	mm
	1.100	27.900
Operating Temperature ²	°F	°C
Standard	-4° to 221°	-20° to 105°
Chemical Resistant	-40 to 221°	-40° to 105°
Mating Cycles No Load by Plating	Silver (Ag)	
Wire and Busbar Contacts	10,000	
Avg. Mating / Unmating Force	Lbf.	N
2 Pole	30	133
Min. Contact / Spring Retention Force		
lbf	150	
N	667	

Materials	
Housing	
Standard Plastic Resin	Polycarbonate
Chem. Resistant Resin	Polycarbonate / PBT blend
Contact Retention Spring	Stainless Steel
Housing Flammability Rating	
UL94	V-0
Glow Wire	960°C (GWFI) / 800°C (GWIT)
Wire & Busbar Contacts ⁴	
Base	Copper Alloy
Plating	Silver
Contact Termination Methods	
Crimp ³	Wire Contacts
Hand Solder	Wire Contacts
Wrench / Socket	Busbar Contacts

NOTE 1: See IEC 60664-1 for working voltage.

¹ Based on: 105°C rated or better cable of the largest size, Properly calibrated APP recommended tooling, and a 25°C ambient temperature. UL rating not to exceed the maximum operating temperature. CSA rating below a 30°C temperature rise.

² Limited by the thermal properties of the connector plastic housing.

³ Use APP recommended tooling only. Alternate tools may adversely affect the performance of our connectors along with UL and CSA recognition.

⁴ Has not been tested by UL.



| IEC INFORMATION |

Connector Series	Configurations	Creepage/Clearance per IEC 60950-1	Material Group
SB®350	Unmated	5.66 mm	IIla
	Mated	5.66 mm	

Attributes	SB350
AMP Rating AC/DC	350
Voltage Rating AC/DC (Steady State)	500 V AC/DC (Operational)
Breaking Capacity - AMP Rating /Cycles	100 Amp / 10 cycles
Voltage Rating (Breaking Capacity)	125 VDC
Finger Safety - Mated only	IEC 60529 - IP20
Wire Size tested	120 mm ²
Contact Series Tested	908
Climatic Testing (Cold, Heat & MFG)	IEC 60512 Test -11j, 11i & 11g,
Cycle Life	IEC 60512 Test 9a - 5000 Cycles
Mechanical Strength Impact	IEC 60512-5 @ 29.5 Inches - dropped 8 times
Temperature Range	-20 °C to 105 °C -4 °F to 221 °F

Protection
Touch Safety with Wire Contacts
IEC 60529 IP10

NOTE 2: Refer to the Constructional Data form for additional information on our website., www.andersonpower.com



SB®350 CONNECTOR TEMPERATURE CHARTS

Temperature rise charts are based on a 25°C ambient temperature.

For Temperature Rise Above 60°C, Consult the Extended Temperature Rise Charts in the Appropriate Product Section on the Website.

Current - Temperature Derating per IEC 60512-5-2 Test 5B

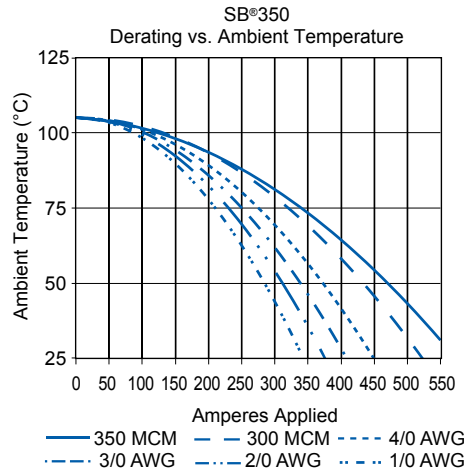
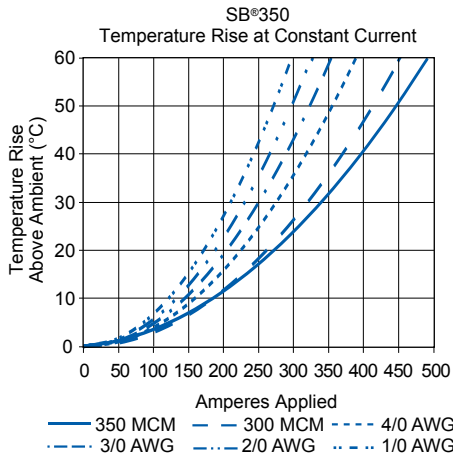

SB® 350 ACCESSORIES

Cable Clamps

Durable metal cable clamps securely hold cables to prevent accidental strain or pulls from dislodging wire or contacts from the housing. Cable clamps are recommended for solder terminated wires.

Description	Cable Size		- Part Numbers -
	Min / Max Inches O.D.	Min / Max mm O.D.	
Minimum Quantity			10
Bolt On for Discrete Conductor	1.00 to 0.35	25.4 to 8.8	996G1
Discrete Conductor w/ Integral Handle	0.76 to 0.32	19.3 to 8.2	911

The given wire O.D. information is an estimate. Cable clamps should be evaluated for performance with the actual wire to be used.

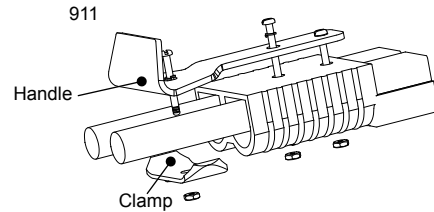
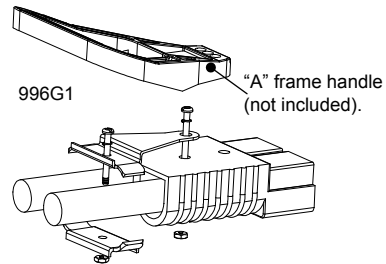

Handles

Handles are made out of durable PC plastic. Hardware to attach to connector body included in kits.

Description	----- Part Numbers -----	
Minimum Quantity	100	25 ...
Gray Handle Kit	-	995G2
Red Handle Kit	-	995G4
Handle Only, Gray	3-5074P1	-
Handle Only, Red	3-5074P3	-
Handle Only, Black	3-5074P5	-
Hardware Bag	-	106G7

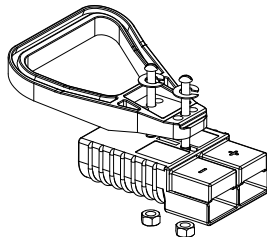

Dust Cover

Prevents dust and dirt from entering the mating interface of the connector when unmated. NOTE: Not a Hermetic Seal.

Description	----- Part Numbers -----	
Minimum Quantity	500	50 ...
Dust Cover with Lanyard Strap, Red	113890P3	134G3

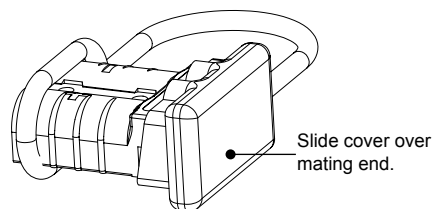

SB®350 Lockout

Works with standard lockout - tagout equipment to prevent access to the mating interface of the connector. Made from durable PC plastic.

Description	--- Part Number ---
Minimum Quantity	25
Red Lockout - Tagout Kit	SB350-LOCKOUT

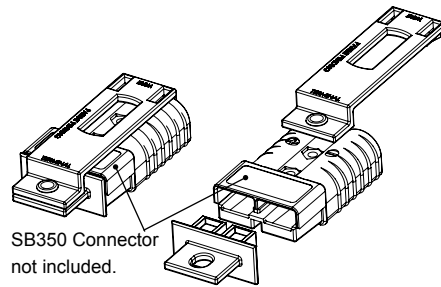

Manual Release Bracket - Mounting Side

Works with the Locking Side to ease mating and unmating connectors.

Description	----- Part Numbers -----		
Minimum Quantity	66	25	10 ...
Bracket and Hardware Kit	-	-	922G1
Bracket Only	B00229P1	-	-
Hardware Bag	-	106G6	-

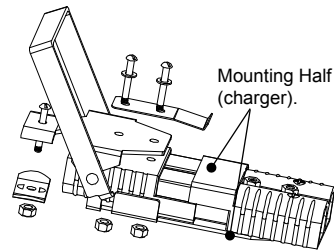

Manual Release Bracket - Locking Side with Cable Clamp

Works with the Mounting Side to ease mating and unmating connectors.

Description	Cable Size		- Part Numbers -
	Min / Max Inches O.D.	Min / Max mm O.D.	
Minimum Quantity			10
Bracket and Hardware Kit w/ Clamp Kit	0.94 to 0.61	23.7 to 15.5	919

The given wire O.D. information is an estimate. Cable clamps should be evaluated for performance with the actual wire to be used.

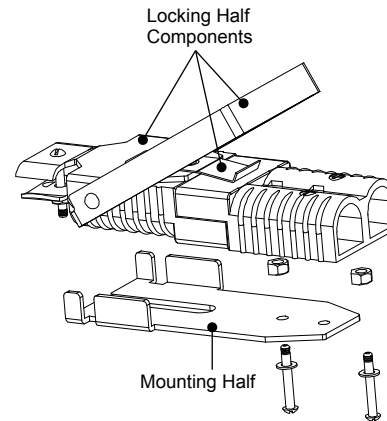

Manual Release Bracket - Locking Side no Cable Clamp

Works with the Battery side to ease mating and unmating connectors.

Description	- Part Numbers -
Minimum Quantity	10
Bracket and Hardware Kit No Clamp Kit	919G1

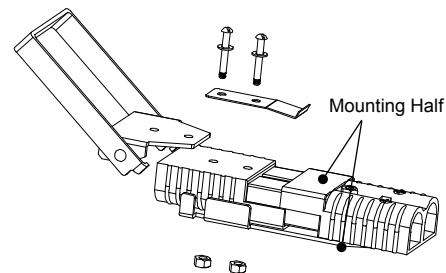

Reducing Bushings: for Use with Contact # 907

Use with contact part number 907-BK to allow a smaller wire to be used with the connector. Electrical capability is derated with smaller wire.

Contact Barrel Size	Wire Size	--- Part Numbers ---	
Minimum Quantity		500	100 ...
2/0 AWG [67.4 mm ²]	1/0 AWG [53.5 mm ²]	5918-BK	5918

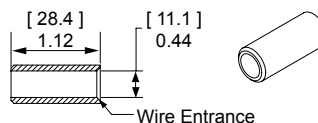

SB®

- Tooling Information

Wire Size		Loose Piece Part Numbers	Loose Piece Contact Crimp Tools				Number of Crimps
AWG	mm²	Silver Plating	Hand Tool	Pneumatic Bench Tool	Die	Locator	
SB®50							
#6	13.3	1307	1309G4	1387G1	1388G6	1389G6	Single
		5900					
#8	8.4	5952					
#10 / 12	5.3 / 3.3	5953			1388G7	1389G7	
		5915					
SB®120							
#1	42.4	1323G1	1368 Series	1387G1	1388G3	1389G4	Single
#2	33.6	1319			1388G4		
#4	21.2	1319G4					
#6	13.3	1319G6					
SB®175							
1/0	53.5	1382	1368 Series	1387G2	1303G13	1304G32	Double
#1	42.4	1347					
#2	33.6	1383					
#4	21.1	1384		1387G1	1388G4	1389G3	Single
#6	13.3	1348					
SB®350							
300mcm	152	910	1368 Series	1387G2	N/A		Double
4/0	107.2	908			1303G3	1304G31	
3/0	85	916			1303G12		
2/0	67.4	907					
1/0	53.5	917					

NOTE: See website for the most current information.

SECTION 3
SB®

SBE®80 / SBO®60 Connectors - up to 80 Amps



SBE® and SBO® connectors build on the capability of the two pole SB® connectors by offering up to 8 auxiliary power / signal contacts along with an IEC 60950 touch safe housing. The center of the main connector features a connector holder for either: two PP15-45, two PPMX, or APP's innovative 1x4 auxiliary connector.

- **Touch Safe Interface**
Minimizes potential contact with live circuits per IEC 60950
- **Up to 8 Last Mate / First Break Auxiliaries**
Enables intelligent power switching, CAN and interlock loop circuitry, as well as power up to 20 amps per pole
- **Silver Plated Wire Contacts up to #4 (25 mm²)**
Allows UL rated currents up to 80 amps per pole

| SBE®80 / SBO®60 ORDERING INFORMATION |

SBE®80 / SBO®60 Housings

The smallest size of SBE®, X, O style housing. SBE®80 and SBO®60 housings of the same Voltage Color Code can be mated but is not recommended as it invalidates UL approvals for SBO®60. SBO®60 housings do not meet EN1175-1 requirements for industrial trucks.

Description	---- SBE®80 Part Numbers ----		---- SBO®60 Part Numbers ----	
Minimum Quantity	400	25	400	25
Yellow	SBE80YEL-BK	SBE80YEL	SBO60YEL-BK	SBO60YEL
Orange	SBE80ORN-BK	SBE80ORN	SBO60ORN-BK	SBO60ORN
Red	SBE80RED-BK	SBE80RED	SBO60RED-BK	SBO60RED
Gray	SBE80GRA-BK	SBE80GRA	N/A	N/A
White	N/A	N/A	SBO60WHT-BK	SBO60WHT

SBE®80 / SBO®60 Silver Plated Primary Power Wire Contacts

Use two silver plated contacts per housing for the best electrical performance and durability up to 10,000 mating cycles. See reducing bushings in accessory section for smaller wire size

AWG	mm ²	Mating Force	- Loose Piece Part Numbers -		Dimensions			
					- A -		- B -	
Minimum Quantity			1,000	100	inches	mm	inches	mm
4	25	Low	1339G4-BK	1339G4 *	0.28	7.11	0.35	9.0
6	16	High	1339G1-BK	1339G1 *	0.22	5.59	0.29	7.3

* Sold as pairs. 2 parts shipped for every 1 part ordered.

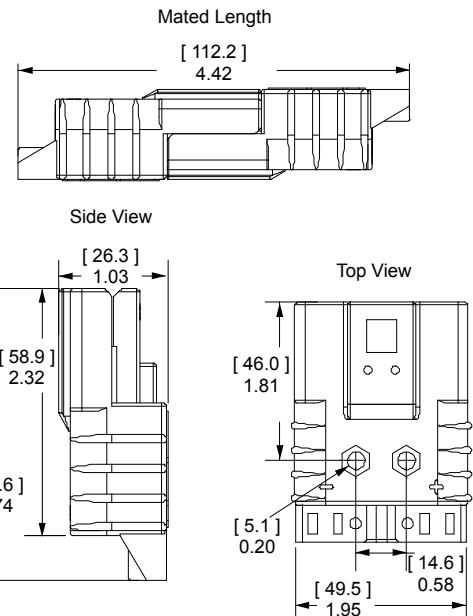
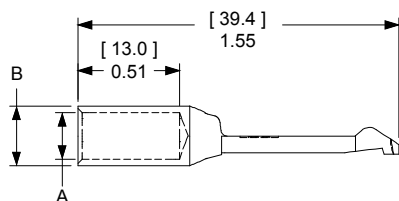

SECTION 3
SBE®80 / SBO®60

| SBE®80 / SBO®60 CONNECTOR SPECIFICATIONS |

Electrical

Current Rating Amperes ¹	SBO60	SBE80
Primary Power (6 AWG)	70	80
Powerpole® Auxiliary (12 AWG)	20	20
1x4 Auxiliary (12 AWG)	20	20
PPMX Auxiliary (20 AWG)	7 UL	5 CSA
Voltage Rating AC/DC		
	UL 1977	EN1175-1
Primary Power	600	150 ⁴
Powerpole® Auxiliary	600	150 ⁴
1x4 Auxiliary	200	
PPMX Auxiliary	300	
Dielectric Withstanding Voltage Primary Power		
Volts AC	2,200	
Avg. Mated Contact Resistance Milliohms ¹		
1 1/4" of #6 AWG wire	0.200	
Hot Plug Current Rating Amperes - 250 cycles at 120V DC		
Power	60A	
Powerpole® Auxiliary	30A	
1x4 Auxiliary	5A	

Materials

Housing	
SBE® / SBO® & 1x4 Auxiliary Housing	Polycarbonate / PBT blend
Powerpole® Plastic Resin	Polycarbonate
Contact Retention Spring	Stainless Steel
Housing Flammability Rating	
UL94	V-0
Glow Wire - SBE80 Only	960°C (GWFI) / 800°C (GWIT)
Power & Powerpole® Contact	
	Silver Plated Copper Alloy
1x4 Auxiliary Contacts	
Pin	Copper alloy, Au over Ni
Socket	BeCu, Au over Ni
Socket Body	Copper alloy, Sn bright over Ni
Retention Clip	Stainless Steel
PPMX Contacts	
	Gold Plated Copper Alloy
Contact Termination Methods	
Crimp ³	
Hand Solder	

Mechanical

Wire Size Range	AWG	mm ²
Power Contacts	6 to 4	16 to 25
Auxiliary Contacts	24 to 10	0.25 to 5.3
Max. Wire Insulation Diameter		
	in.	mm
Power Contacts	0.440	11.200
Powerpole® Auxiliary	0.175	4.450
1x4 Auxiliary	0.140	3.600
Operating Temperature ²		
SBO® and SBE® Housings	°F	°C
	-4° to 221°	-20° to 105°
Mating Cycles No Load by Plating		
	Silver (Ag)	Gold (Au)
Power Contacts	10,000	
Powerpole® Auxiliary	10,000	
1x4 Auxiliary		10,000
PPMX Auxiliary		5,000
Avg. Mating / Unmating Force		
	Lbf.	N
Main Connector Housing	16	70
Per Powerpole® Connector	5	22
Per Contact in 1x4 Auxiliary	0.7	3.0
Per PPMX Housing	4.50	20.00
Min. Contact / Spring Retention Force		
	Lbf.	N
Power Standard Housing	50	222
Powerpole® Housing	25	111
1x4 Auxiliary Housing	10	44.5
PPMX Housing	12	53

NOTE 1: See IEC 60664-1 for working voltage.

NOTE 2: Amp ratings are stated per position and based on all positions being fully loaded.

¹ Based on: 105°C rated or better cable of the largest size, Properly calibrated APP recommended tooling, and a 25°C ambient temperature. UL rating not to exceed the maximum operating temperature. CSA rating below a 30°C temperature rise. Only SBO®60 has UL recognition.

² Limited by the thermal properties of the connector plastic housing.

³ Use APP recommended tooling only. Alternate tools may adversely affect the performance of our connectors along with UL and CSA recognition.

⁴ Voltage capability of SBE® housings is identical to SBO®, but derated to meet EN1175-1 requirements.



| IEC INFORMATION |

Connector Series	Configurations	Creepage/Clearance per IEC 60950-1	Material Group
SBE®80	Unmated	4.23 mm	IIla
	Mated	7.9 mm	

Protection

Touch Safety Main Connector Housing	
IEC 60950	Pass
IEC 60529	IP20

NOTE 3: Refer to the Constructional Data form for additional information on our website., www.andersonpower.com



| SBE®80 / SBO®60 CONNECTOR TEMPERATURE CHARTS |

Temperature rise charts are based on a 25°C ambient temperature.

For Temperature Rise Above 60°C, Consult the Extended Temperature Rise Charts in the Appropriate Product Section on the Website.

Current - Temperature Derating per IEC 60512-5-2 Test 5B

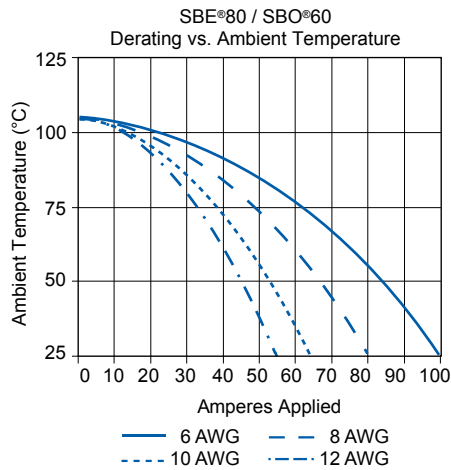
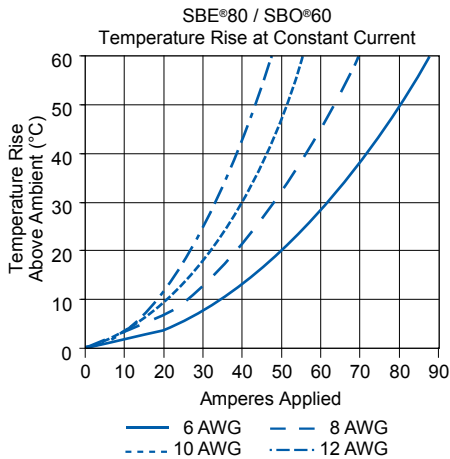

| SBE®80 / SBO®60 ACCESSORIES |

Cable Clamps

Clamps are made out the same chemical resistant PBT material that is used in the SBE® housings. Clamp holds the cable between the clamp piece and the connector housing. Screws must be ordered separately for part numbers starting with "113".

Description	Part Numbers	
Minimum Quantity	100	25
Red Clamp and Hardware Kit	-	SBE80CLPRED or SBO60CLPRED
Red Clamp Only	113953P1	-
Screws (2 per clamp)	H1120P42 (Individual)	-

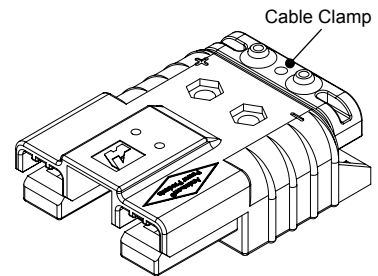

"T" Handle

Handles are made out the same chemical resistant PBT material that is used in the SBE® housings. (2) screws and (2) nuts are required to attach each handle.

Description	Part Numbers		
Minimum Quantity	500	100	25
Red Handle and Hardware Kit	-	-	SBE80HDLRED or SBO60HDLRED
Red Handle Only	113952P1	-	-
Hardware Bag	-	-	105G13
M5 x 35mm Screws	-	113715P4	-
M5 Nut	-	113716P3	-

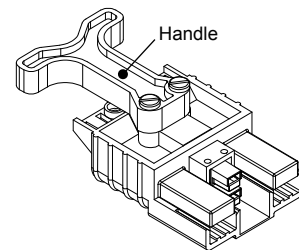

Powerpole® Auxiliary

Powerpole® auxiliary connectors are rated up to 30 amps 600 volts and can be used for auxiliary power, control or sensing. The auxiliary kit includes (1) each black and red Standard Powerpole® housing, (2) contacts, (2) zip cable straps, and (2) retaining pins.

Description	Part Numbers	
Minimum Quantity	200	25
Powerpole® Auxiliary Kit	-	6344
Black Powerpole® Housing	1327G6	-
Red Powerpole® Housing	1327	-
#16 to #12 Contact	1331	-
Retaining Pin	-	-

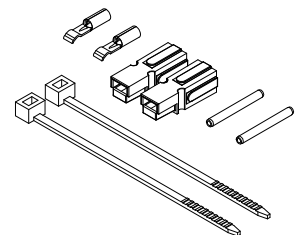

1x4 Auxiliary Connector

The unique 1x4 auxiliary connector allows up to 4 auxiliary circuits up to 20 amps 200 volts each in SBE®, SBO®, & SBX® housings. The genderless design holds two each of the gold plated pin & socket contacts. This innovation allows the very durable and cost effective design of SBE®, O, X connectors to substitute for DIN 43589-1 applications where 4 auxiliary contacts are required. Multiple pin lengths allow the further benefit of sequencing between circuits.

(2) Retaining pins are required to hold the auxiliary housing in place. Auxiliary Kits include (1) Auxiliary Housing, (2) Standard Length Pin Contacts, and (2) Socket Contacts, (2) Retaining Pins and (1) Retaining Clip.

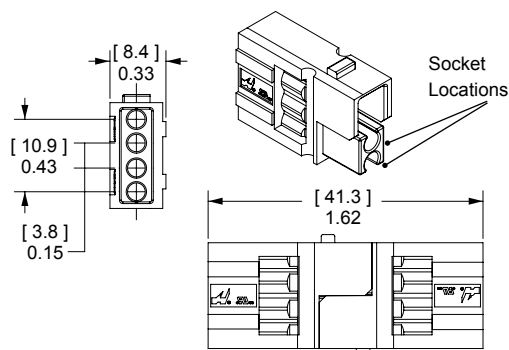

Description	AWG	mm ²	Part Numbers		
Minimum Quantity			1,000	250	25 ...
1x4 Auxiliary Kit	12	4	-	-	441G3
1x4 Auxiliary Kit	16 to 14	1.5 to 2.5	-	-	441G1
1x4 Auxiliary Kit	20 to 16	0.75 to 1.5	-	-	441G2
1x4 Auxiliary Housing	Contacts Sold Separately		3-5956P1	444G1	-

Pin Contacts for 1x4 Auxiliary Connector

Gold plated contacts are available in 4 lengths to allow sequencing of circuits.

Description	AWG	mm ²	Part Numbers	
Minimum Quantity			500	50
Standard Length 7.7mm	12	2.5	PM16P12S30	PM16P12S30-50
	16 to 14	1.0 to 1.5	PM16P1416S30	PM16P1416S30-50
	20 to 16	0.75 to 1.0	PM16P1620S30	PM16P1620S30-50
	24 to 20	0.50 to 0.75	PM16P2024S30	PM16P2024S30-50
Pre-Mate 9.3mm	12	2.5	PM16P12A30	-
	16 to 14	1.0 to 1.5	PM16P1416A30	-
	20 to 16	0.75 to 1.0	PM16P1620A30	-
	24 to 20	0.50 to 0.75	PM16P2024A30	-
Post-Mate 6.4mm	12	2.5	PM16P12C30	-
	16 to 14	1.0 to 1.5	PM16P1416C30	-
	20 to 16	0.75 to 1.0	PM16P1620C30	-
	24 to 20	0.50 to 0.75	PM16P2024C30	-

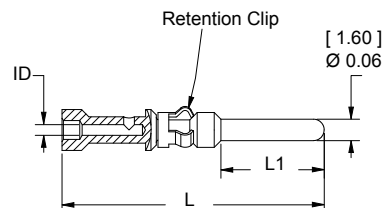

Auxiliary Pin Contact Lengths	- L -		- L1 -	
	in.	mm	in.	mm
Standard Length 7.7mm	0.77	19.6	0.30	7.7
Pre-Mate 9.3mm	0.83	21.2	0.37	9.3
Post-Mate 6.4mm	0.72	18.3	0.25	6.4

Socket Contacts for 1x4 Auxiliary Connector

Selectively gold plated contacts offer low resistance and durability up to 10,000 mating cycles.

Description	AWG	mm ²	Part Numbers	
Minimum Quantity			500	50
Socket Contact	12	2.5	PM16S12S32	PM16S12S32-50
	16 to 14	1.0 to 1.5	PM16S1416S32	PM16S1416S32-50
	20 to 16	0.75 to 1.0	PM16S1620S32	PM16S1620S32-50
	24 to 20	0.50 to 0.75	PM16S2024S32	PM16S2024S32-50

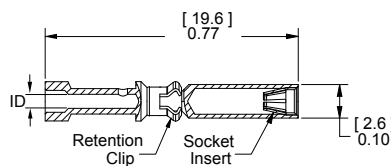

Auxiliary Socket Contacts Crimp Barrel ID		
Wire Gauge	in.	mm.
#24 / 20	0.04	1.1
#20 / 16	0.07	1.7
#16 / 14	0.08	2.1
#12	0.10	2.6

PPMX Auxiliary Connector

The PPMX auxiliary connector allows up to 8 auxiliary circuits to be used in the SBE®, SBO®, & SBX® housings. There are 4 auxiliary circuits per PPMX connector and two PPMX housings fit into the auxiliary port in the main connector housing. Rated up to 7 amps 300 volts per contact, the genderless design holds two each gold plated pin & socket contacts. This innovation allows the very durable and cost effective equipment design of SBE®, O, X connectors to be used for applications requiring up to 8 battery monitoring or vehicle communication circuits. (2) Retaining pins or (1) Retaining clip is required to hold the auxiliary housing in place.

Auxiliary Kits include (1) Auxiliary Housing, (2) Pin Contacts, and (2) Socket Contacts.

Description	AWG	mm ²	Part Numbers		
Minimum Quantity			1,000	100	25
PPMX Auxiliary Kit	24 to 20	0.50 to 0.25	-	4850G6	-
1x4 Auxiliary Housing	Contacts Sold Separately		4827G6-BK	-	4827G6

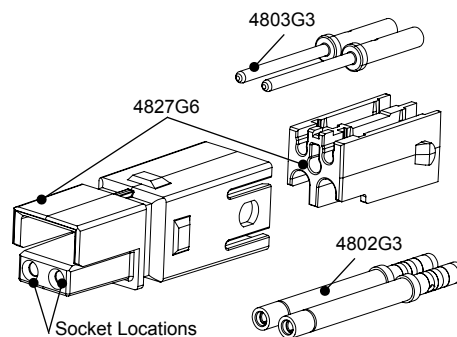

* No extraction tool required for contact removal.

Pin & Socket Contacts for PPMX Auxiliary Connector

Gold plated contacts are ideal for signal or low power use with durability up to 5,000 mating cycles.

Description	AWG	mm ²	----- Part Numbers -----	
Minimum Quantity			2,000	50
Pin Contacts	24 to 20	0.50 to 0.25	4803G3-BK	4803G3
Socket Contacts	24 to 20	0.50 to 0.25	4802G3-BK	4802G3

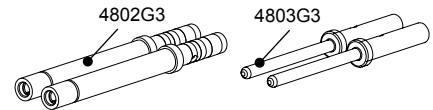

NOTE: Contacts sold individually, not sold as a set of two.

SBE® Air Tubes

Air tubes fit into SBE® housings to allow electrolyte circulation while charging the battery. Genderless tube design allows the same part to be used on both sides. (2) Retaining pins are required to hold the air tube in place. Retaining pins are included in Air Tube Kit.

Description	----- Part Numbers -----	
Minimum Quantity	500	25
Air Tube Kit, Black	-	6396G1
Air Tube Only	3-5798P1	-

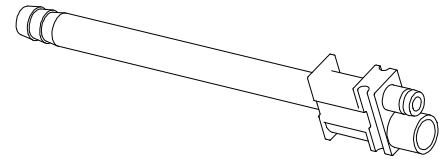

Retaining Pins

Retaining pins are used to hold accessories in the auxiliary port in SBE®, SBO®, & SBX® housings. Dimension "B" is +/- 0.015 in or 0.38 mm.

Description	--- Part Numbers ---		Dimensions			
	1,000	100	- A -		- B -	
			inches	mm	inches	mm
Minimum Quantity	1,000	100				
For SBE®80 & SBO®60	110G9-BK	110G9	0.093 / 0.099	2.36 / 2.51	0.85	21.59

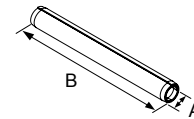

Zip Cable Straps

Zip cable straps are used to secure auxiliary wires to the side of the main power cables.

Description	-- Part Number --
Minimum Quantity	1,000
White	H1835P3

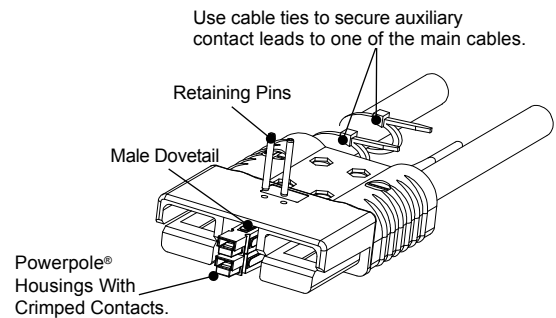

Reducing Bushings

Use with contact part number 1339G1 to allow a smaller wire to be used with the connector. Electrical capability is derated with smaller wire.

Contact Barrel Size	Wire Size	----- Part Numbers -----		Dimensions				
		3,000	1,000	100	- ID -		- Length -	
					inches	mm	Inches	mm
Minimum Quantity		3,000	1,000	100				
#6 AWG [13.3 mm ²]	#8 AWG [8.4 mm ²]	-	5912-BK	5912	0.18	4.57	0.45	11.43
#6 AWG [13.3 mm ²]	#12- 10 AWG [3.3- 5.3 mm ²]	5910-BK	-	5910	0.14	3.56	0.47	11.94
#6 AWG [13.3 mm ²]	#16- 14 AWG [1.3- 2.1 mm ²]	5913-BK	-	5913	0.09	2.29	0.47	11.94

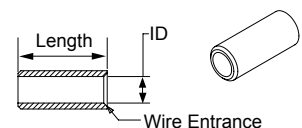

SBE®160 / SBX®175 Connectors

- up to 175 Amps



SBX® and SBE® connectors can integrate up to 8 auxiliary power / signal contacts along with the two primary power circuits. SBE® connectors feature an IEC 60950 touch safe housing molded from a chemical resistant PBT/PC blend resin. SBX® are molded from a rugged PC resin and are rated IP20 per IEC 60529.

- Touch Safe Interface**
Minimizes potential contact with live circuits per IEC 60950 & IEC 60529
- Up to 8 Last Mate / First Break Auxiliaries**
Enables intelligent power switching, CAN and interlock loop circuitry, as well as power up to 20 amps per pole
- Color-coded Mechanical Voltage Keys**
Like all Multipole connectors, the SBE® and SBX® offer an easy way to identify circuits and protect against cross mating

| SBE®160 / SBX®175 ORDERING INFORMATION |

SBE®160 / SBX®175 Housings

The middle size of SBE®, X, O style housing. SBE® housings are molded from a chemical resistant PBT. SBX® housings are molded from PC. SBE®160 and SBX®175 housings of the same Voltage Color Code can be mated (except yellow) but is not recommended as it invalidates UL approvals. SBX®175 housings do not meet EN1175-1 requirements for industrial trucks.

Description	- SBE®160 Part Numbers -		- SBX®175 Part Numbers -			
	Minimum Quantity	100	25	100	25
Yellow	2-8170G4	E6383G1	2-7251G4	6383G1		
Orange	2-8170G3	E6382G1	2-7251G3	6382G1		
Red	2-8170G5	E6385G1	2-7251G5	6385G1		
Gray	2-8170G1	E6380G1	2-7251G1	6380G1		
Blue	2-8170G2	E6381G1	2-7251G2	6381G1		
Green	2-8170G7	E6390G1	2-7251G7	6390G1		
Black	2-8170G14	E6392G1	N/A	N/A		

* Yellow SBE®160 and SBX®175 housings are NOT intermateable.

SBE®160 / SBX®175 Silver Plated Primary Power Wire Contacts

Use two silver plated contacts per housing for the best electrical performance and durability up to 10,000 mating cycles. See reducing bushings in accessory section for smaller wires.

AWG	mm ²	- Loose Piece Part Numbers -		Dimensions - A -	
		Minimum Quantity..	500	50	inches
1/0	50	6384G1-BK	6384G1 *	0.44	11.1
2	35	6384G2-BK	6384G2 *	0.38	9.7

* Sold as pairs. 2 parts shipped for every 1 part ordered.

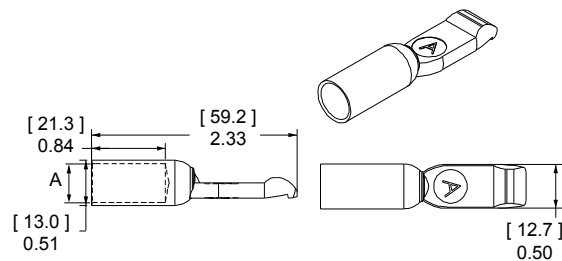
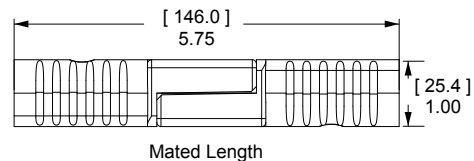
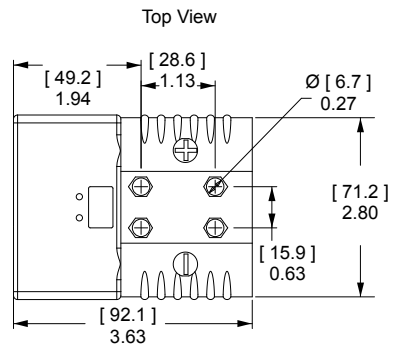

SBE®160 / SBX®175 CONNECTOR SPECIFICATIONS |

Electrical		
Current Rating Amperes ¹	SBX175	SBE160
Primary Power (1/0 AWG)	175	160
Powerpole® Auxiliary (12 AWG)	20	20
1x4 Auxiliary (12 AWG)	20	20
PPMX Auxiliary (20 AWG)	7 UL	5 CSA
Voltage Rating AC/DC	UL 1977	EN1175-1
Primary Power	600	150 ⁴
Powerpole® Auxiliary	600	150 ⁴
1x4 Auxiliary	200	
PPMX Auxiliary	300	
Dielectric Withstanding Voltage Primary Power		
Volts AC	2,200	
Avg. Mated Contact Resistance Milliohms ¹		
6" of 1/0 AWG wire	0.100	
UL Hot Plug Current Rating Amperes - 250 cycles at 120V DC		
Power	75A	
Powerpole® Auxiliary	30A	
1x4 Auxiliary	5A	

Materials	
Housing	
SBX® and Powerpole® Plastic Resin	Polycarbonate
SBE® and 1x4 Auxiliary Housing	Polycarbonate / PBT blend
Contact Retention Spring	Stainless Steel
Housing Flammability Rating	
UL94	V-0
Glow Wire - SBE160 Only	960°C (GWFI) / 850°C (GWIT)
Power & Powerpole® Contact	Silver Plated Copper Alloy
1x4 Auxiliary Contacts	
Pin	Copper alloy, Au over Ni
Socket	BeCu, Au over Ni
Socket Body	Copper alloy, Sn bright over Ni
Retention Clip	Stainless Steel
PPMX Contacts	Gold Plated Copper Alloy
Contact Termination Methods	
Crimp ³	
Hand Solder	

Mechanical		
Wire Size Range	AWG	mm²
Power Contacts	10 to 1/0	5.3 to 53.5
Auxiliary Contacts	24 to 10	0.25 to 5.3
Max. Wire Insulation Diameter	in.	mm
Power Contacts	0.600	15.200
Powerpole® Auxiliary	0.175	4.450
1x4 Auxiliary	0.140	3.600
Operating Temperature ²	°F	°C
SBX® and SBE® Housings	-4° to 221°	-20° to 105°
Mating Cycles No Load by Plating	Silver (Ag)	Gold (Au)
Power Contacts	10,000	
Powerpole® Auxiliary	10,000	
1x4 Auxiliary		10,000
PPMX Auxiliary		5,000
Avg. Mating / Unmating Force	Lbf.	N
Main Connector Housing	30	134
Per Powerpole® Connector	5.00	22.00
Per Contact in 1x4 Auxiliary	0.70	3.00
Per PPMX Housing	4.50	20.00
Min. Contact / Spring Retention Force	Lbf.	N
Power Standard Housing	120	533.7
Powerpole® Housing	25	111
1x4 Auxiliary Housing	10	44.5
PPMX Housing	12	53

NOTE 1: See IEC 60664-1 for working voltage.

NOTE 2: Amp ratings are stated per position and based on all positions being fully loaded.

¹ Based on: 105°C rated or better cable of the largest size, Properly calibrated APP recommended tooling, and a 25°C ambient temperature. UL rating not to exceed the maximum operating temperature. CSA rating below a 30°C temperature rise.

² Limited by the thermal properties of the connector plastic housing.

³ Use APP recommended tooling only. Alternate tools may adversely affect the performance of our connectors along with UL and CSA recognition.

⁴ Voltage capability of SBE® housing is identical to SBX®, but derated to meet EN1175-1 requirements.



IEC INFORMATION |

Connector Series	Configurations	Creepage/Clearance per IEC 60950-1	Material Group
SBE®160	Unmated	6.1 mm	IIla
	Mated	11.6 mm	

Attributes	SBE160
AMP Rating AC/DC	160 Amp
Voltage Rating AC/DC (Steady State)	600 V AC/DC (Operational)
Breaking Capacity -AMP Rating /Cycles	160 Amp / 10 Cycles
Voltage Rating (Breaking Capacity)	220 VDC
FINGER Safety - Mated/Unmated	IEC 60529 - IP20
Wire Size tested	50 mm ²
Contact Series Tested	6384G1
Climatic Testing (Cold,Heat & MFG)	IEC 60512 Test -11j, 11i & 11g,
Cycle Life	IEC 60512 Test 9a - 5000 Cycles
Mechanical Strength Impact	IEC 60512-5 @ 29.5 Inches - dropped 8 times
Temperature Range	-20 °C to 105 °C -4 °F to 221 °F

Protection	
Touch Safety Main Connector Housing	
IEC 60950 SBE®160 Only	Pass
IEC 60529 SBX®175 Only	IP20

NOTE 3: Refer to the Constructional Data form for additional information on our website., www.andersonpower.com



| SBE®160 / SBX®175 CONNECTOR TEMPERATURE CHARTS|

Temperature rise charts are based on a 25°C ambient temperature.

For Temperature Rise Above 60°C, Consult the Extended Temperature Rise Charts in the Appropriate Product Section on the Website.

Current - Temperature Derating per IEC 60512-5-2 Test 5B

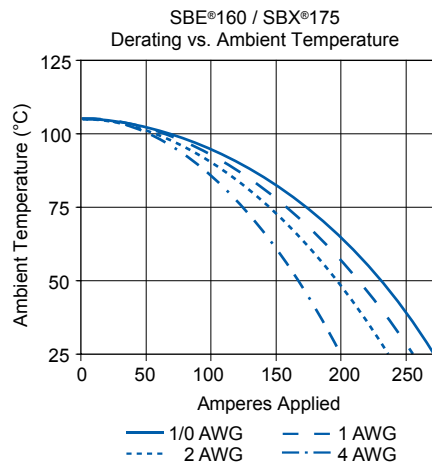
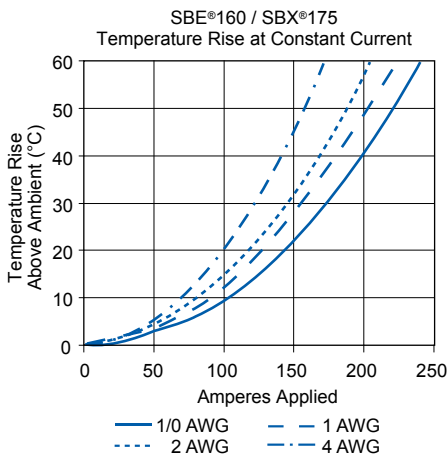

| SBE®160 / SBX®175 ACCESSORIES |

Cable Clamps

Durable metal clamps adapt to a wide range of cable sizes.

Description	Cable Size		- Part Number -
	Min / Max Inches O.D.	Min / Max mm O.D.	
Minimum Quantity			25
Cable Clamp Kit	0.62 to 0.22	15.7 to 5.6	945G2

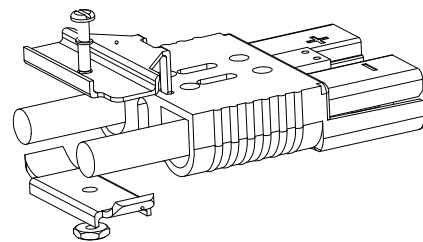

The given wire O.D. information is an estimate. Cable clamps should be evaluated for performance with the actual wire to be used.

Handles

Handles are made out of durable PC plastic. Hardware to attach to connector body included in kits.

Description	----- Part Numbers -----	
Minimum Quantity...	100	25 ..
Gray Handle Kit	995G1-APP	995G1
Red Handle Kit	995G3-APP	995G3
Handle Only, Gray	3-5074P1	-
Handle Only, Red	3-5074P3	-
Handle Only, Black	3-5074P5	-
Hardware Bag	-	105G8

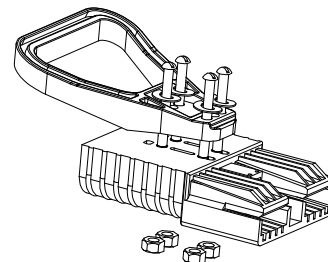

Powerpole® Auxiliary

Powerpole® auxiliary connectors are rated up to 30 amps 600 volts and can be used for auxiliary power, control or sensing. The auxiliary kit includes (1) each black and red Standard Powerpole® housing, (2) contacts, (2) zip cable straps, and (2) retaining pins. (1) Retaining clip can be substituted for (2) retaining pins.

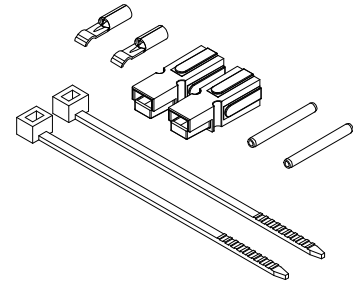

Description	--- Part Numbers ---	
Minimum Quantity	200	25 ...
Powerpole® Auxiliary Kit	-	6344
Black Powerpole® Housing	1327G6	-
Red Powerpole® Housing	1327	-
#16 to #12 Contact	1331	-

1x4 Auxiliary Connector

The unique 1x4 auxiliary connector allows up to 4 auxiliary circuits up to 20 amps 150 volts each in SBE®, SBO®, & SBX® housings. The genderless design holds two each of the gold plated pin & socket contacts. This innovation allows the very durable and cost effective design of SBE®, O, X connectors to substitute for DIN 43589-1 applications where 4 auxiliary contacts are required. Multiple pin lengths allow the further benefit of sequencing between circuits. (2) Retaining pins or (1) Retaining clip is required to hold the auxiliary housing in place. Auxiliary Kits include (1) Auxiliary Housing, (2) Standard Length Pin Contacts, (2) Socket Contacts, (2) Retaining Pins and (1) Retaining Clip.

Description	AWG	mm ²	----- Part Numbers -----		
Minimum Quantity			1,000	250	25 ...
1x4 Auxiliary Kit	12	4	-	-	441G3
1x4 Auxiliary Kit	16 to 14	1.5 to 2.5	-	-	441G1
1x4 Auxiliary Kit	20 to 16	0.75 to 1.5	-	-	441G2
1x4 Auxiliary Housing	Contacts Sold Separately		3-5956P1	444G1	-

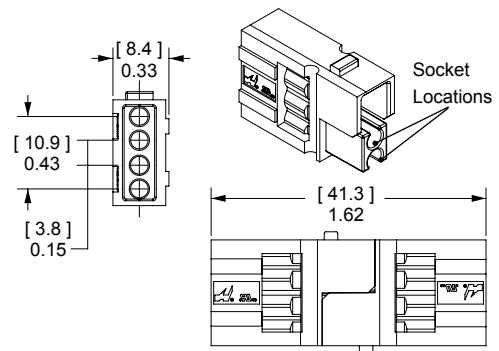

Pin Contacts for 1x4 Auxiliary Connector

Gold plated contacts are available in 4 lengths to allow sequencing of circuits.

Description	AWG	mm ²	----- Part Numbers -----	
Minimum Quantity			500	50
Standard Length 7.7mm	12	2.5	PM16P12S30	PM16P12S30-50
	16 to 14	1.0 to 1.5	PM16P1416S30	PM16P1416S30-50
	20 to 16	0.75 to 1.0	PM16P1620S30	PM16P1620S30-50
	24 to 20	0.50 to 0.75	PM16P2024S30	PM16P2024S30-50
Pre-Mate 9.3mm	12	2.5	PM16P12A30	-
	16 to 14	1.0 to 1.5	PM16P1416A30	-
	20 to 16	0.75 to 1.0	PM16P1620A30	-
	24 to 20	0.50 to 0.75	PM16P2024A30	-
Post-Mate 6.4mm	12	2.5	PM16P12C30	-
	16 to 14	1.0 to 1.5	PM16P1416C30	-
	20 to 16	0.75 to 1.0	PM16P1620C30	-
	24 to 20	0.50 to 0.75	PM16P2024C30	-

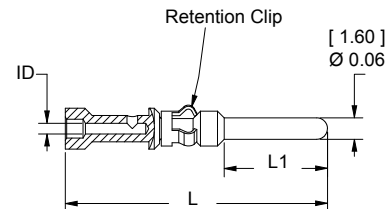

Auxiliary Pin Contact Lengths	- L -		- L1 -	
	in.	mm	in.	mm
Standard Length 7.7mm	0.77	19.6	0.30	7.7
Pre-Mate 9.3mm	0.83	21.2	0.37	9.3
Post-Mate 6.4mm	0.72	18.3	0.25	6.4

Socket Contacts for 1x4 Auxiliary Connector

Selectively gold plated contacts offer low resistance and durability up to 10,000 mating cycles.

Description	AWG	mm ²	Part Numbers	
Minimum Quantity			500	50
Socket Contact	12	2.5	PM16S12S32	PM16S12S32-50
	16 to 14	1.0 to 1.5	PM16S1416S32	PM16S1416S32-50
	20 to 16	0.75 to 1.0	PM16S1620S32	PM16S1620S32-50
	24 to 20	0.50 to 0.75	PM16S2024S32	PM16S2024S32-50

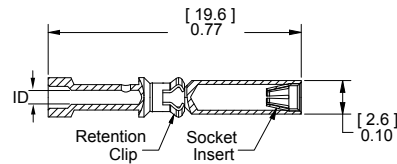

Auxiliary Socket Contacts Crimp Barrel ID		
Wire Gauge	in.	mm.
#24 / 20	0.04	1.1
#20 / 16	0.07	1.7
#16 / 14	0.08	2.1
#12	0.10	2.6

PPMX Auxiliary Connector

The PPMX auxiliary connector allows up to 8 auxiliary circuits to be used in the SBE®, SBO®, & SBX® housings. There are 4 auxiliary circuits per PPMX connector and two PPMX housings fit into the auxiliary port in the main connector housing. Rated up to 7 amps 300 volts per contact, the genderless design holds two each gold plated pin & Socket contacts. This innovation allows the very durable and cost effective design of SBE®, O, X connectors to be used for applications requiring up to 8 battery monitoring or equipment vehicle communication circuits. (2) Retaining pins or (1) Retaining clip is required to hold the auxiliary housing in place.

Auxiliary Kits includes: (1) Auxiliary Housing, (2) Pin Contacts, and (2) Socket Contacts.

Description	AWG	mm ²	Part Numbers		
Minimum Quantity			1,000	100	25
PPMX Auxiliary Kit	24 to 20	0.50 to 0.25	-	4850G6	-
1x4 Auxiliary Housing	Contacts Sold Separately		4827G6-BK	-	4827G6

* No extraction tool required for contact removal.

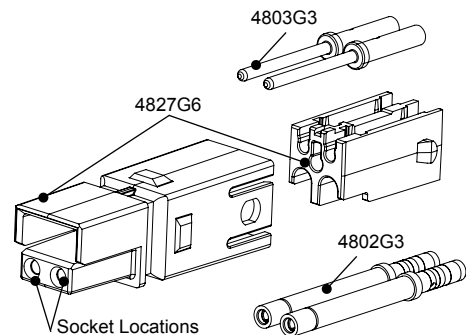

Pin & Socket Contacts for PPMX Auxiliary Connector

Gold plated contacts are ideal for signal or low power use with durability up to 5,000 mating cycles.

Description	AWG	mm ²	Part Numbers	
Minimum Quantity			2,000	50
Pin Contacts	24 to 20	0.50 to 0.25	4803G3-BK	4803G3
Socket Contacts	24 to 20	0.50 to 0.25	4802G3-BK	4802G3

SBE® Air Tubes

Air tubes fit into SBE® housings to allow electrolyte circulation while charging the battery. Genderless tube design allows the same part to be used on both sides. (2) Retaining pins or (1) Retaining clip is required to hold the air tube in place. Retaining pins are included in Air Tube Kit.

Description	Part Numbers	
Minimum Quantity	500	25
Air Tube Kit, Black	-	6396G1
Air Tube Only	3-5798P1	-

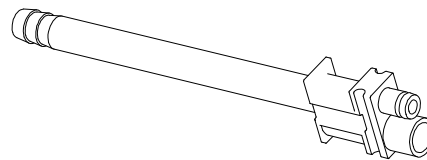

Retaining Clip

Retaining clips can be used in place of two retaining pins to hold auxiliary connectors or air tubes. Allows easier removal of auxiliary modules.

Description	Part Number
Minimum Quantity	100
For SBE®160 & SBX®175	2-8675P2

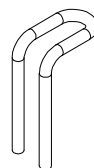

Retaining Pins

Retaining pins are used to hold accessories in the auxiliary port in SBE®, SBO®, & SBX® housings. Dimension "B" is +/- 0.015 in or 0.38 mm.

Description	--- Part Numbers ---		Dimensions			
			- A -		- B -	
			inches	mm	inches	mm
Minimum Quantity	1,000	100				
For SBE®160 & SBX®175	110G9-BK	110G9	0.093 / 0.099	2.36 / 2.51	0.85	21.59

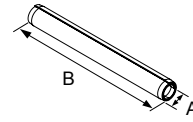

Zip Cable Straps

Zip cable straps are used to secure auxiliary wires to the side of the main power cables.

Description	- Part Number -
Minimum Quantity ..	1,000
White	H1835P3

Use cable ties to secure auxiliary contact leads to one of the main cables.

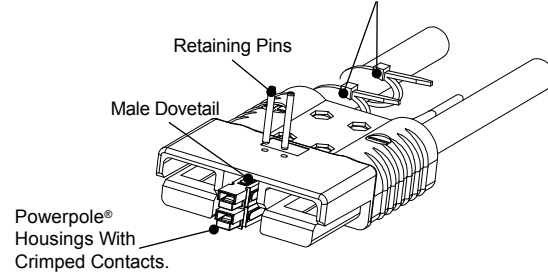

Manual Release - Battery Side

Works with the Charger / Truck side to ease mating and unmating connectors.

Description	--- Part Numbers ---	
Minimum Quantity	88	25 ...
Bracket and Hardware Kit	-	993G2
Battery Bracket Only	111961P2	-
Hardware Bag	-	105G1

Manual Release - Charger / Truck Side

Works with the Battery side to ease mating and unmating connectors.

Description	----- Part Numbers -----	
Minimum Quantity	60	25 ...
Bracket and Hardware Kit	-	994G2
Bracket / Lever Only	B00511G2	-
Hardware Bag	-	105G1

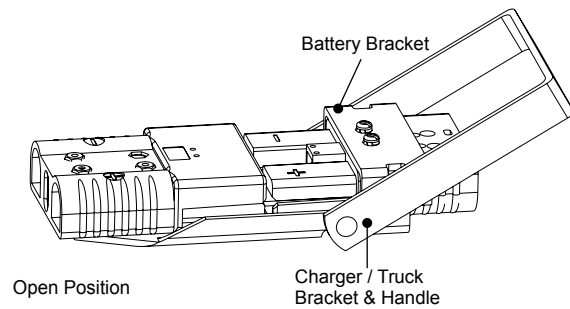

Reducing Bushings: for Use with Contact # 6384G1

Use with contact part number 6384G1-BK to allow a smaller wire to be used with the connector. Electrical capability is derated with smaller wire.

Contacts Barrel Size	Wire Size	----- Part Numbers -----				Dimensions - ID -	
		1,500	1,000	500	100	inches	mm
Minimum Quantity							
1/0 AWG [53.5 mm²]	#1 AWG [42.4 mm²]	-	-	5687-BK	5687	0.39	9.91
1/0 AWG [53.5 mm²]	#2 AWG [33.6 mm²]	5690-BK	-	-	5690	0.34	8.64
1/0 AWG [53.5 mm²]	#4 AWG [21.2 mm²]	-	5693-BK	-	5693	0.27	6.86
1/0 AWG [53.5 mm²]	#6 AWG [13.3 mm²]	-	5663-BK	-	5663	0.22	5.59
1/0 AWG [53.5 mm²]	#10 - 8 AWG [5.3 - 8.4 mm²]	5648-BK	-	-	5648	0.19	4.83

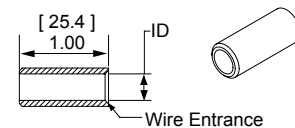

Reducing Bushings: for Use with Contact # 6384G2

Use with contact part number 6384G2-BK to allow a smaller wire to be used with the connector. Electrical capability is derated with smaller wire.

Contact Barrel Size	Wire Size	----- Part Numbers -----	
Minimum Quantity		1,000	100
35 mm²	16 mm²	5920-BK	5920

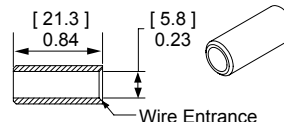

SBE®320 / SBX®350 Connectors

- up to 350 Amps



SBX® and SBE® connectors can integrate up to 8 auxiliary power / signal contacts along with the two primary power circuits. Sequencing within auxiliary positions is possible using the 4 pin lengths available in the 1x4 auxiliary connector. The SBE® touch safety rating is equivalent to that of the SBS® connector line.

- **Silver Plated Wire Contacts up to 300 mcm (152 mm²)**
Allows low resistance UL rated currents up to 350 amps per pole
- **Up to 8 Last-mate / First-break Auxiliaries**
Enables intelligent power switching, CAN and interlock loop circuitry, as well as power up to 20 amps per pole
- **Durable Housings and Contacts**
Like all Multipole connectors, the silver plated power contacts are rated up to 10,000 mating cycles

| SBE®320 / SBX®350 ORDERING INFORMATION |

SBE®320 / SBX®350 Housings

The largest size of SBE®, X, O style housing. SBE® housings are molded from a chemical resistant PBT. SBX® housings are molded from PC. SBE®320 and SBX®350 housings of the same Voltage Color Code cannot be mated. SBX®350 housings do not meet EN1175-1 requirements for industrial trucks.

Description	- SBE®320 Part Numbers -		- SBX®350 Part Numbers -		
	Minimum Quantity	100	25	100	25
Yellow	2-8171G6	E6362	2-7249G6	6362	
Orange	2-8171G7	E6339	2-7249G7	6339	
Red	2-8171G3	E6352	2-7249G3	6352	
Gray	2-8171G1	E6350	2-7249G1	6350	
Blue	2-8171G2	E6351	2-7249G2	6351	
Green	2-8171G4	E6353	2-7249G4	6353	
Black	2-8171G5	E6361	2-7249G5	6361	
Brown	2-8171G8	E6336	N/A	N/A	
Purple	2-8171G9	E6349	N/A	N/A	

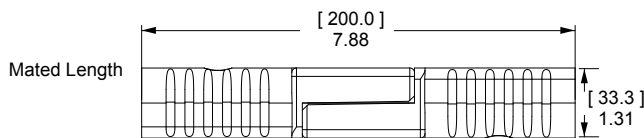
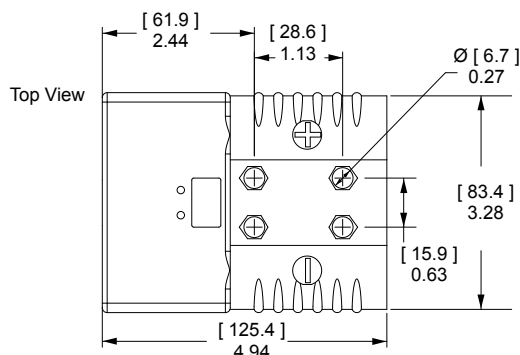

SBE®320 / SBX®350 Silver Plated Primary Power Wire Contacts

Silver plated contacts offer superior electrical performance and durability up to 10,000 mating cycles. See reducing bushings in accessory section for smaller wires.

AWG	mm ²	- Loose Piece Part Numbers -		Dimensions								
				- A -		- B -		- C -		- D -		
				inches	mm	inches	mm	inches	mm	inches	mm	
Minimum Quantity		200	150	50							
300 mcm	150	-	6358-BK	6358 *	3.03	76.96	0.88	22.20	0.75	19.05	1.25	31.80
4/0	120	6356-BK	-	6356 *	3.10	78.74	0.75	19.05	0.64	16.26	1.25	31.80
3/0	95	6355-BK	-	6355 *	3.10	78.74	0.70	17.78	0.58	14.73	1.25	31.80
2/0	70	6354-BK	-	6354 *	3.10	78.74	0.64	16.26	0.49	12.45	1.25	31.80
2	35	6394-BK	-	6394 *	3.10	78.74	0.51	12.95	0.38	9.50	1.25	31.80

* Sold as pairs. 2 parts shipped for every 1 part ordered.

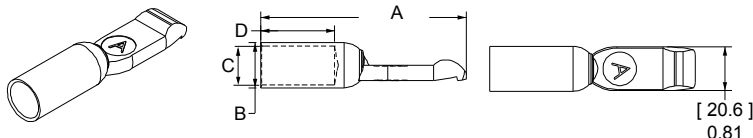

SBE®320 DIN Standard Silver Plated Primary Power Wire Contacts

Crimp barrel O.D. are compliant with DIN standard tooling. Will also fit into SBX®350 housings. Not recommended for cross mating with above typical contacts for SBE® & SBX®.

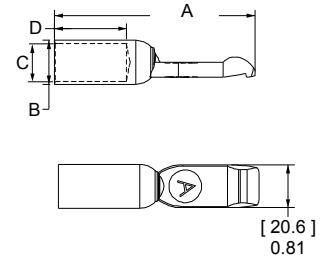

AWG	mm ²	Loose Piece		Dimensions							
		Part Numbers		- A -		- B -		- C -		- D -	
Minimum Quantity ...		200	50	inches	mm	inches	mm	inches	mm	inches	mm
3/0	95	1341G3-BK	1341G3 *	2.89	73.41	0.78	19.81	0.59	14.99	0.94	23.88
2/0	70	1341G2-BK	1341G2 *	2.74	69.60	0.68	17.27	0.51	12.95	0.79	20.07
1/0	50	1341G1-BK	1341G1 *	2.65	67.31	0.57	14.48	0.43	10.92	0.79	20.07

* Sold as pairs. 2 parts shipped for every 1 part ordered.

| SBE®320 / SBX®350 CONNECTOR SPECIFICATIONS |

Electrical			
Current Rating Amperes ¹	SBX350	SBE320	
Primary Power (300 mcm)	350	320	
Powerpole® Auxiliary (12 AWG)	20	20	
1x4 Auxiliary (12 AWG)	20	20	
PPMX Auxiliary (20 AWG)	7 UL	5 CSA	
Voltage Rating AC/DC	UL 1977	EN1175-1	
Primary Power	600	150 ⁴	
Powerpole® Auxiliary	600	150 ⁴	
1x4 Auxiliary	200		
PPMX Auxiliary	300		
Dielectric Withstanding Voltage Primary Power			
Volts AC	2,200		
Avg. Mated Contact Resistance Milliohms ¹			
2 1/2" of 300mcm wire	0.050		

Materials		
Housing		
SBX® and Powerpole® Plastic Resin	Polycarbonate	
SBE®, PPMX Auxiliary and 1x4 Auxiliary Housing	Polycarbonate / PBT blend	
Contact Retention Spring	Stainless Steel	
Housing Flammability Rating		
UL94	V-0	
Glow Wire - SBE320 Only	960°C (GWFI) / 850°C (GWIT)	
Power & Powerpole® Contact	Silver Plated Copper Alloy	
1x4 Auxiliary Contacts		
Pin	Copper alloy, Au over Ni	
Socket	BeCu, Au over Ni	
Socket Body	Copper alloy, Sn bright over Ni	
Retention Clip	Stainless Steel	
PPMX Contacts	Gold Plated Copper Alloy	
Contact Termination Methods		
Crimp ³		
Hand Solder		

Mechanical			
Wire Size Range	AWG	mm²	
Power Contacts	1/0 to 300 mcm	53.5 to 152	
Auxiliary Contacts	24 to 10	0.25 to 5.3	
Max. Wire Insulation Diameter	in.	mm	
Power Contacts	0.440	11.200	
Powerpole® Auxiliary	0.175	4.450	
1x4 Auxiliary	0.140	3.600	
Operating Temperature ²	°F	°C	
SBX Housing and SBX With Auxiliary	-4° to 221°	-20° to 105°	
SBE Housing	-40° to 221°	-40° to 105°	
SBE Housing With Powerpole Auxiliary	-4° to 221°	-20° to 105°	
SBE Housing With 1x4 and PPMX Auxiliary	-40° to 221°	-40° to 105°	
Mating Cycles No Load by Plating	Silver (Ag)	Gold (Au)	
Power Contacts	10,000		
Powerpole® Auxiliary	10,000		
1x4 Auxiliary		10,000	
PPMX Auxiliary		5,000	
Avg. Mating / Unmating Force	Lbf.	N	
Main Connector Housing	45	200	
Per Powerpole® Connector	5.00	22.00	
Per Contact in 1x4 Auxiliary	0.70	3.00	
Per PPMX Housing	4.50	20.00	
Min. Contact / Spring Retention Force	Lbf.	N	
Power Standard Housing	150	667.2	
Powerpole® Housing	25	111	
1x4 Auxiliary Housing	10	44.5	
PPMX Housing	12	53	

NOTE 1: See IEC 60664-1 for working voltage.

NOTE 2: Amp ratings are stated per position and based on all positions being fully loaded.

¹ Based on: 105°C rated or better cable of the largest size, Properly calibrated APP recommended tooling, and a 25°C ambient temperature. UL rating not to exceed the maximum operating temperature. CSA rating below a 30°C temperature rise.

² Limited by the thermal properties of the connector plastic housing.

³ Use APP recommended tooling only. Alternate tools may adversely affect the performance of our connectors along with UL and CSA recognition.

⁴ Voltage capability of SBE® housings is identical to SBX®, but derated to meet EN1175-1 requirements.



IEC INFORMATION |

Connector Series	Configurations	Creepage/Clearance per IEC 60950-1	Material Group
SBE®320	Unmated	5.6 mm	IIla
	Mated	24.7 mm	

Attributes	SBE320
AMP Rating AC/DC	320 Amp
Voltage Rating AC/DC (Steady State)	600 V AC/DC (Operational)
Breaking Capacity -AMP Rating /Cycles	275 Amp / 10 Cycles
Voltage Rating (Breaking Capacity)	220 VDC
FINGER Safety - Mated/Unmated	IEC 60529 - IP20
Wire Size tested	120 mm ²
Contact Series Tested	6356
Climatic Testing (Cold,Heat & MFG)	IEC 60512 Test -11j, 11i & 11g,
Cycle Life	IEC 60512 Test 9a - 5000 Cycles
Mechanical Strenght Impact	IEC 60512-5 @ 29.5 Inches dropped 8 times
Temperature Range	-20 °C to 105 °C -4 °F to 221 °F

Protection	
Touch Safety Main Connector Housing	
IEC 60950 SBE®320 Only	Pass
IEC 60529 SBE®320 & SBX®350	IP20

NOTE 3: Refer to the Constructional Data form for additional information on our website., www.andersonpower.com



| SBE® 320 / SBX®350 CONNECTOR TEMPERATURE CHARTS|

Temperature rise charts are based on a 25°C ambient temperature.

For Temperature Rise Above 60°C, Consult the Extended Temperature Rise Charts in the Appropriate Product Section on the Website.

Current - Temperature Derating per IEC 60512-5-2 Test 5B

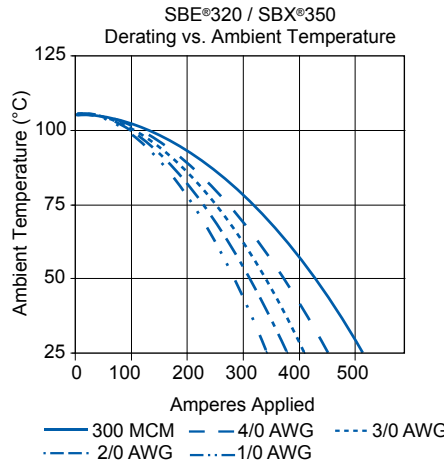
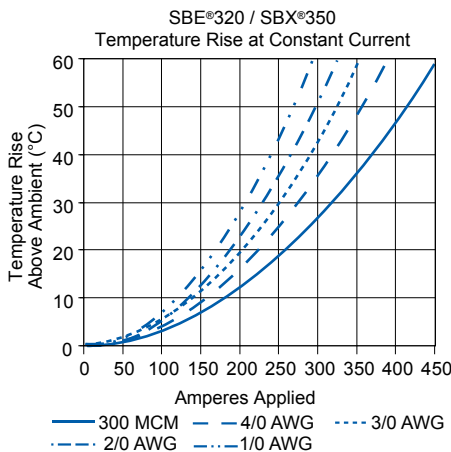

| SBE® 320 / SBX®350 ACCESSORIES |

Cable Clamps

Durable metal clamps adapt to a wide range of cable sizes. Cable clamp kit includes Clamp Top and Bottom as well as the Hardware Bag.

Description	Cable Size		- Part Number -
	Min / Max Inches O.D.	Min / Max mm O.D.	
Minimum Quantity			25
Cable Clamp Kit	0.85 to 0.67	21.6 to 17.1	911G2

The given wire O.D. information is an estimate. Cable clamps should be evaluated for performance with the actual wire to be used.

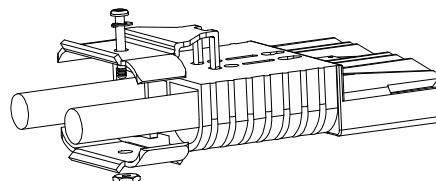

Handles

Handles are made out of durable PC plastic. Hardware to attach to connector body included in kits.

Description	----- Part Numbers -----	
Minimum Quantity	100	25 ...
Gray Handle Kit	995G2-APP	995G2
Red Handle Kit	995G4-APP	995G4
Handle Only, Gray	3-5074P1	-
Handle Only, Red	3-5074P3	-
Handle Only, Black	3-5074P5	-
Hardware Bag	-	106G7

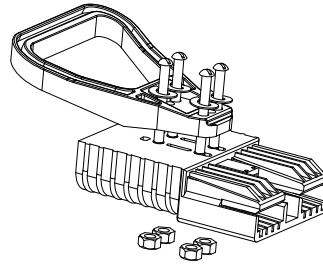

Powerpole® Auxiliary

Powerpole® auxiliary connectors are rated up to 30 amps 600 volts and can be used for auxiliary power, control or sensing. The auxiliary kit includes (1) each black and red Standard Powerpole® housing, (2) contacts, (2) zip cable straps, and (2) retaining pins. (1) Retaining clip can be substituted for (2) retaining pins.

Description	----- Part Numbers -----	
Minimum Quantity	200	25 ...
Powerpole® Auxiliary Kit #16 to #12 Contact	-	6305G1
Powerpole® Auxiliary Kit #20 to #16 Contact	-	6310G1
Black Powerpole® Housing	1327G6	-
Red Powerpole® Housing	1327	-
#16 to #12 Contact	1331	-
#20 to #16 Contact	1332	-

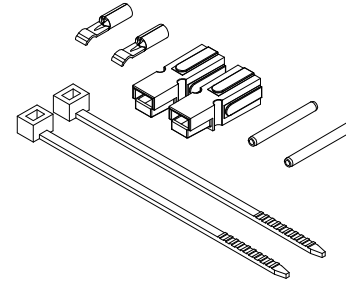

1x4 Auxiliary Connector

The unique 1x4 auxiliary connector allows up to 4 auxiliary circuits up to 20 amps 150 volts each in SBE®, SBO®, & SBX® housings. The genderless design holds two each of the gold plated pin & socket contacts. This innovation allows the very durable and cost effective design of SBE®, O,X connectors to substitute for DIN 43589-1 applications where 4 auxiliary contacts are required. Multiple pin lengths allow the further benefit of sequencing between circuits. (2) Retaining pins or (1) Retaining clip is required to hold the auxiliary housing in place. Auxiliary Kits include (1) Auxiliary Housing, (2) Standard Length Pin Contacts, (2) Socket Contacts, (2) Retaining Pins and (1) Retaining Clip.

Description	AWG	mm ²	----- Part Numbers -----		
Minimum Quantity			1,000	250	25 ...
1x4 Auxiliary Kit	12	4	-	-	440G3
1x4 Auxiliary Kit	16 to 14	1.5 to 2.5	-	-	440G1
1x4 Auxiliary Kit	20 to 16	0.75 to 1.5	-	-	440G2
1x4 Auxiliary Housing	Contacts Sold Separately		3-5956P1	444G1	-

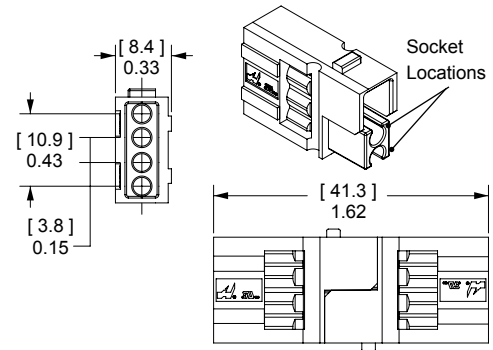

Pin Contacts for 1x4 Auxiliary Connector

Gold plated contacts are available in 4 lengths to allow sequencing of circuits.

Description	AWG	mm ²	----- Part Numbers -----	
Minimum Quantity			500	50
Standard Length 7.7mm	12	2.5	PM16P12S30	PM16P12S30-50
	16 to 14	1.0 to 1.5	PM16P1416S30	PM16P1416S30-50
	20 to 16	0.75 to 1.0	PM16P1620S30	PM16P1620S30-50
	24 to 20	0.50 to 0.75	PM16P2024S30	PM16P2024S30-50
Pre-Mate 9.3mm	12	2.5	PM16P12A30	PM16P12A30-50
	16 to 14	1.0 to 1.5	PM16P1416A30	PM16P1416A30-50
	20 to 16	0.75 to 1.0	PM16P1620A30	PM16P1620A30-50
	24 to 20	0.50 to 0.75	PM16P2024A30	PM16P2024A30-50
Post-Mate 6.4mm	12	2.5	PM16P12C30	PM16P12C30-50
	16 to 14	1.0 to 1.5	PM16P1416C30	PM16P1416C30-50
	20 to 16	0.75 to 1.0	PM16P1620C30	PM16P1620C30-50
	24 to 20	0.50 to 0.75	PM16P2024C30	PM16P2024C30-50

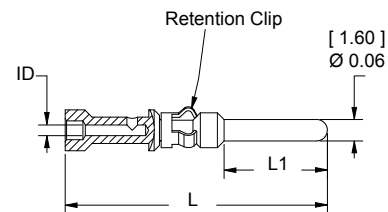

Auxiliary Pin Contact Lengths	- L -		- L1 -	
	in.	mm	in.	mm
Standard Length 7.7mm	0.77	19.6	0.30	7.7
Pre-Mate 9.3mm	0.83	21.2	0.37	9.3
Post-Mate 6.4mm	0.72	18.3	0.25	6.4

Socket Contacts for 1x4 Auxiliary Connector

Selectively gold plated contacts offer low resistance and durability up to 10,000 mating cycles.

Description	AWG	mm ²	----- Part Numbers -----	
Minimum Quantity			500	50
Socket Contact	12	2.5	PM16S12S32	PM16S12S32-50
	16 to 14	1.0 to 1.5	PM16S1416S32	PM16S1416S32-50
	20 to 16	0.75 to 1.0	PM16S1620S32	PM16S1620S32-50
	24 to 20	0.50 to 0.75	PM16S2024S32	PM16S2024S32-50

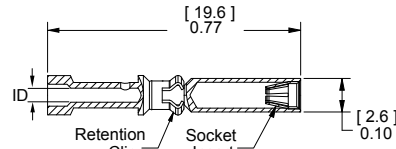

Auxiliary Socket Contacts Crimp Barrel ID

Wire Gauge	in.	mm.
#24 / 20	0.04	1.1
#20 / 16	0.07	1.7
#16 / 14	0.08	2.1
#12	0.10	2.6

SBE® Air Tubes

Air tubes fit into SBE® housings to allow electrolyte circulation while charging the battery. Genderless tube design allows the same part to be used on both sides. (2) Retaining pins or (1) Retaining clip is required to hold the air tube in place. Retaining pins are included in Air Tube Kit.

Description	---- Part Numbers ----	
Minimum Quantity	500	25 ...
Air Tube Kit, Black	-	6396G1
Air Tube Only	3-5798P1	-

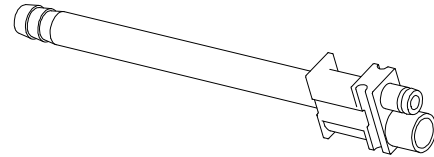

PPMX Auxiliary Connector

The PPMX auxiliary connector allows up to 8 auxiliary circuits to be used in the SBE®, SBO®, & SBX® housings. There are 4 auxiliary circuits per PPMX connector and two PPMX housings fit into the auxiliary port in the main connector housing. Rated up to 7 amps 300 volts per contact, the genderless design holds two each gold plated pin & socket contacts. This innovation allows the very durable and cost effective design of SBE®, O, X connectors to be used for applications requiring up to 8 battery monitoring or equipment vehicle communication circuits. (2) Retaining pins or (1) Retaining clip is required to hold the auxiliary housing in place.

Auxiliary Kits includes: (1) Auxiliary Housing, (2) Pin Contacts, and (2) Socket Contacts.

Description	AWG	mm ²	----- Part Numbers -----		
Minimum Quantity			1,000	100	25
PPMX Auxiliary Kit	24 to 20	0.50 to 0.25	-	4850G6	-
1x4 Auxiliary Housing	Contacts Sold Separately		4827G6-BK	-	4827G6

* No extraction tool required for contact removal.

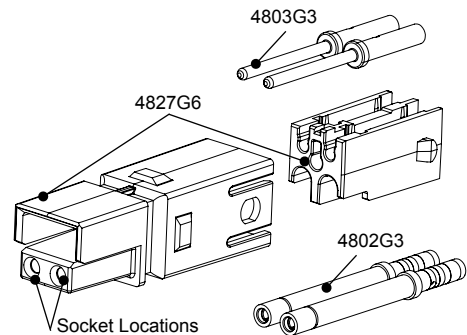

Pin & Socket Contacts for PPMX Auxiliary Connector

Gold plated contacts are ideal for signal or low power use with durability up to 5,000 mating cycles.

Description	AWG	mm ²	----- Part Numbers -----	
Minimum Quantity			2,000	50 ...
Pin Contacts	24 to 20	0.50 to 0.25	4803G3-BK	4803G3
Socket Contacts	24 to 20	0.50 to 0.25	4802G3-BK	4802G3

Retaining Clip

Retaining clips can be used in place of two retaining pins to hold auxiliary connectors or air tubes. Allows easier removal of auxiliary modules.

Description	-- Part Number --
Minimum Quantity	100
For SBE®320 & SBX®350	2-8675P1

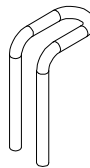

Retaining Pins

Retaining pins are used to hold accessories in the auxiliary port in SBE®, SBO®, & SBX® housings. Dimension "B" is +/- 0.015 in or 0.38 mm.

Description	- Part Number -	Dimensions			
		- A -		- B -	
		inches	mm	inches	mm
Minimum Quantity	1,000				
For SBE®320 & SBX®350	110G59-BK	0.093 / 0.103	2.36 / 2.62	1.000	25.40

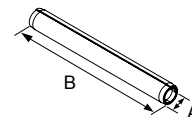

Zip Cable Straps

Zip cable straps are used to secure auxiliary wires to the side of the main power cables.

Description	--- Part Number ---
Minimum Quantity...	1,000
White	H1835P3

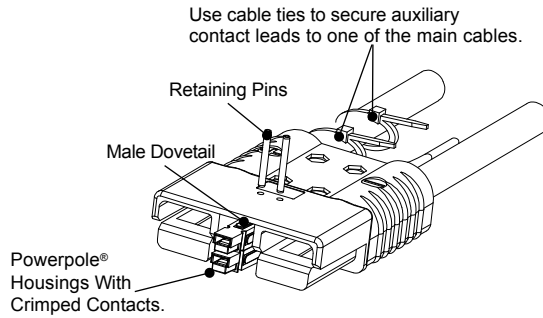

Manual Release - Battery Side

Works with the Charger / Truck side to ease mating and unmating connectors.

Description	--- Part Numbers ---	
Minimum Quantity	72	25
Bracket and Hardware Kit	-	993G1
Battery Bracket Only	111961P1	-
Hardware Bag	-	106G6

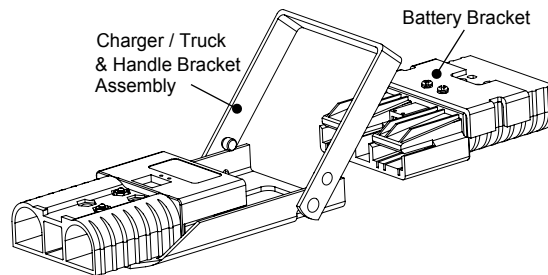

Manual Release - Charger/ Truck Side

Works with the Battery side to ease mating and unmating connectors.

Description	- Part Numbers -	
Minimum Quantity	25
Bracket and Hardware Kit	994G1	
Bracket / Lever Only	B00511G4	
Hardware Bag	106G6	

Reducing Bushings: for Use with Contact # 6354 and Bushing # 5918

Use with contact part number 6354-BK and bushing part number 5918-BK to allow a smaller wire to be used with the connector. Electrical capability is derated with smaller wire.

Bushings # 5918 Barrel Size Wire Size	----- Part Numbers -----				Dimensions - ID -	
	1,500	1,000	500	100	inches	mm
Minimum Quantity	1,500	1,000	500	100		
1/0 AWG [53.5 mm²] #1 AWG [42.4 mm²]	-	-	5687-BK	5687	0.39	9.91
1/0 AWG [53.5 mm²] #2 AWG [33.6 mm²]	5690-BK	-	-	5690	0.34	8.64
1/0 AWG [53.5 mm²] #4 AWG [21.2 mm²]	-	5693-BK	-	5693	0.27	6.86
1/0 AWG [53.5 mm²] #6 AWG [13.3 mm²]	-	5663-BK	-	5663	0.22	5.59
1/0 AWG [53.5 mm²] #10 - 8 AWG [5.3 - 8.4 mm²]	5648-BK	-	-	5648	0.19	4.83

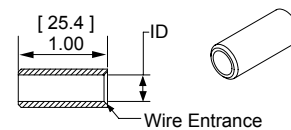

Reducing Bushings: for Use with Contact # 6354

Use with contact part number 6354-BK to allow a smaller wire to be used with the connector. Electrical capability is derated with smaller wire.

Contact Barrel Size Wire Size	--- Part Number ---	
Minimum Quantity	500	100 ...
2/0 AWG [67.4 mm²] 1/0 AWG [53.5 mm²]	5918-BK	5918

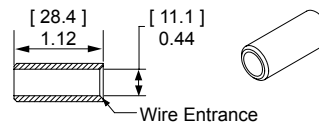

Reducing Bushings: for Use with Contact # 6394

Use with contact part number 6394-BK to allow a smaller wire to be used with the connector. Electrical capability is derated with smaller wire.

Contact Barrel Size Wire Size	-- Part Numbers --		Dimensions - ID -	
			inches	mm
Minimum Quantity	1,000	100		
35 mm²	16 mm²	5920-BK 5920	0.23	5.8

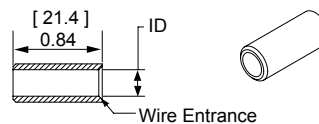

SBO® / SBE® / SBX® - Tooling Information

Wire Size		Loose Piece Part Numbers Contacts	Loose Piece Contact Crimp Tool				
AWG	mm ²		Pneumatic Bench Tool	Die	Locator	Number of Crimps	or Hand Tool
SBE® 320 / SBX® 350							
300 MCM	152	6358	N/A	N/A	N/A	N/A	1368 Series
4/0 AWG	107.2	6356	1387G2	1303G12	1304G28	Double	
3/0 AWG	85	6355					
2/0 AWG	67.4	6354					
#2	N/A	6394					
N/A	95 mm ²	1341G3	1387G2	1303G17	1304G35	Double	
N/A	70 mm ²	1341G2					
N/A	70 mm ²	1341G2					
N/A	50 mm ²	1341G1					
SBE® 160 / SBX® 175							
1/0 AWG	53.5	6384G1	1387G2	1303G2	1304G13	Single	1368 Series
#2	35 mm ²	6384G2	1387G1	1388G3	1389G3		
			1387G2	1303G2	1304G13		
SBO® 60 / SBE® 80							
#4	25	1339G4	1387G1	1388G7	1389G9	Single	N/A
#6	16	1339G1		1388G6			1309G4
Powerpole® 15/45 Auxiliary Contacts **							
#16 / 20	1.3 / .52	1332	N/A	N/A	N/A	Single	1309G2 or 1309G8
#12 / 16	3.3 / 1.3	1331					
PowerMod® 1x4 Auxiliary Contacts							
#12 / 24	2.5 / .25	All Crimp Pins	TP0001*	N/A	TL0001	Single	TM0001*
		All Crimp Sockets			TL0002		PM1000G1
PPMX Auxiliary Contacts							
#20 / 24	0.50 / 0.25	4803G3	TP0001*	N/A	TL0005	Single	TM0001* or
		4802G3					PM1000G1

* TP0001 and TM0001 tools require locators to properly position contacts.

** See Powerpole® family tooling chart for other Powerpole® contacts

SBE®160 / SBX®175 Power Contact Extraction Tool: 969P1

SBE®320 / SBX®350 Power Contact Extraction Tool: 970P1

1 x 4 Auxiliary contact Insertion Tool: PM1002G1

1 x 4 Auxiliary Contact Extraction Tool: PM1003G1

The auxiliary contacts used with wire sizes #16 - #24 AWG cannot be properly inserted without the insertion tool. Properly installed auxiliary contact of all wire gauges cannot be removed from the housing without the extraction tool.

SB® Smart Connector - up to 230 Amps



Battery

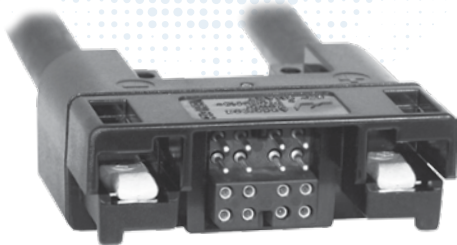

Vehicle Device

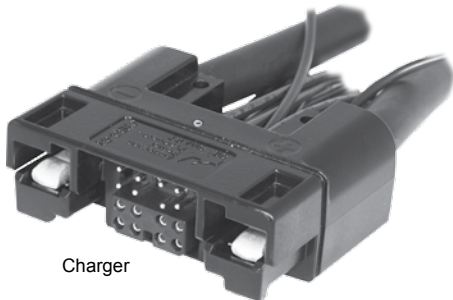

Charger

The SB® Smart is designed for applications where storage batteries intelligently interact with the system. Two primary power positions (up to 230 amps each) are combined with sixteen auxiliary power / signal positions (up to 15 amps each) into a single interconnect solution. This allows one connection to be used to route high power lines, low power lines, and signal circuits.

Unique to the SB® Smart is its selective keyed housings that allow only mating between select connector halves. This prevents motors from mating with chargers, chargers from mating with chargers, or other undesirable connection scenarios.

- **Selective Keyed Housings**

Unique keying feature only allows intended connector halves to mate

- **Power and Auxiliary Contacts**

Provides power up to 230 amps plus signal & low power in a single connector

- **16 Last-Mate First-Break Auxiliary Power / Signal Poles**

Enables the power connector to also transmit signals for intelligent power switching, battery monitoring, CAN communication, loop circuitry, and other signal or power circuits up to 15 amps

- **Sequencing of Auxiliary Contacts**

Male auxiliary contacts available in 3 lengths

- **Wire and Busbar Connections**

Satisfies multiple interconnect needs with one connection solution

- **Low Resistance Connection**

- Silver plated power contacts are strongly forced together by stainless steel springs
- Gold plated auxiliary contacts ensure signal quality or reliable power

- **Hot Plug Capable Contacts**

- Power contacts are hot plug capable up to 60A at 120VDC
- Auxiliary contacts are hot plug capable up to 5A at 120VDC

| ORDERING INFORMATION |

SB® Smart Housings (Auxiliary Module Sold Separately)

Color	Housing Type / Marking	Mates With	--- Part Numbers ---
Black	Battery BAT-G1	VEH-G2 & CHR-G4	115158G1
Black	Vehicle / Device VEH-G2	BAT-G1	115158G2
Black	Charger CHR-G4	BAT-G1	115158G4

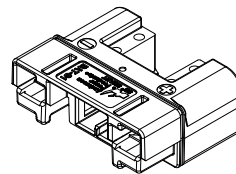

Top View

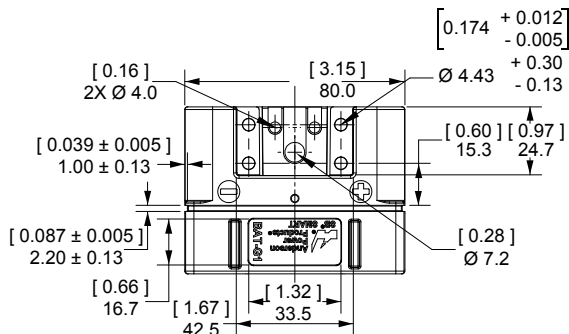

Side View

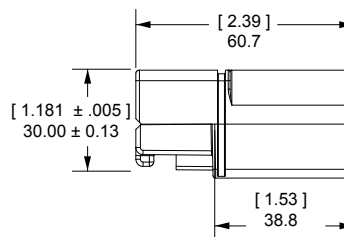

Mated Pairings Illustrations

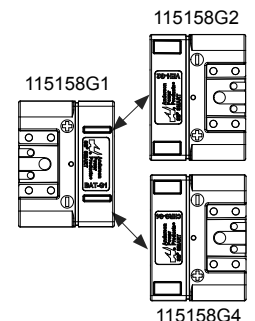

SB®Smart Silver Plated Wire Contacts

Silver plated contacts offer superior electrical performance and durability up to 10,000 mating cycles. New contacts for #1 to 1/0 AWG (35 to 50 mm²) offer extended capability in the same housings.

AWG	mm ²	Mating Force	----- Loose Piece Part Numbers -----			- A -		- B -	
						inches	mm	inches	mm
Minimum Quantity			600	500	50				
1/0	53.5	Low	1323G2-BK	-	1323G2	0.52	13.21	0.44	11.18
1	42.4	Low	1323G1-BK	-	1323G1	0.47	11.94	0.39	9.91
2	33.6	High	-	1319-BK	1319	0.44	11.18	0.34	8.64
4	21.1	High	-	1319G4-BK	1319G4	0.44	11.18	0.29	7.37
6	13.3	High	-	1319G6-BK	1319G6	0.44	11.18	0.22	5.59

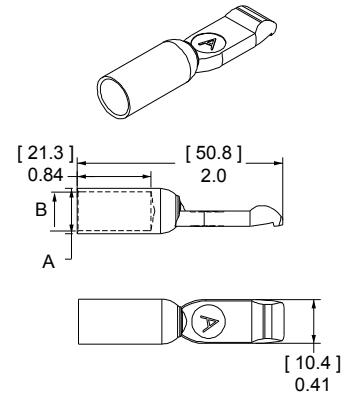

SB®Smart Silver Plated Busbar Contacts

Use 2 busbar contacts per housing to provide a quick disconnect input or output busbar connection. Busbar contacts are for mating with wire contacts only. Part number 120BBS includes lock nuts. Locknuts must be ordered separately for B01997P1.

Type	Thread	Mating Force	----- Loose Piece Part Numbers -----			
Minimum Quantity			1,000	300	20	10
Busbar	#10-24	High	-	B01997P1	-	120BBS
Lock Nut	#10-24	-	H1216P8	-	110G54	-

See Busbar contact drawing on website for further detail.

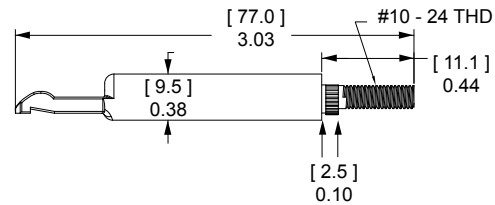

Reducing Bushings

Use with contact part number 1319-BK or 6811G6-BK to allow a smaller wire to be used with the connector. Electrical capability is derated with smaller wire.

Contact Barrel Size	Wire Size	----- Part Numbers -----			Dimensions - ID -	
					inches	mm
Minimum Quantity		2,000	1,000	100		
#2 AWG [33.6 mm ²]	#4 AWG [21.2 mm ²]	5919-BK	-	5919	0.28	7.11
#2 AWG [33.6 mm ²]	#6 AWG [16 mm ²]	-	5920-BK	5920	0.23	5.84
#2 AWG [33.6 mm ²]	#10 - 8 AWG [5.3 - 8.4 mm ²]	5921-BK	-	5921	0.18	4.57

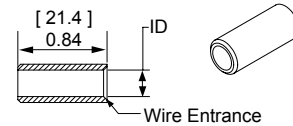

SB®Smart Auxiliary Module

Color	Number of Positions	- Part Number -
Minimum Quantity		
Black	8 Pins + 8 Sockets	3-6018P1

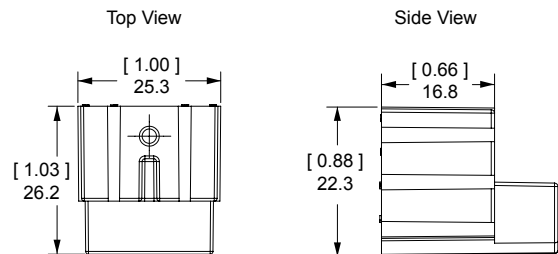
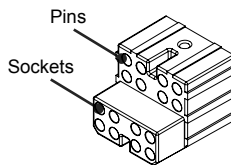
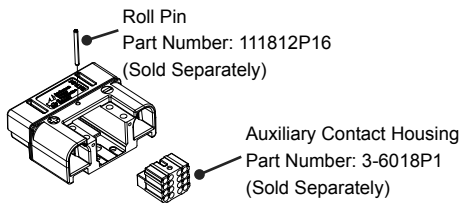

Retaining Pins

Retaining pins are used to hold the auxiliary module in the SB® Smart housings. Dimension "B" is +/- 0.01 in or 0.25 mm.

Description	- Part Number -	Dimensions		
		- A -	- B -	
Minimum Quantity ...			inches	mm
For SB® Smart				
Auxiliary Module	111812P16	0.099 / 0.106	2.51 / 2.69	1.125 28.58

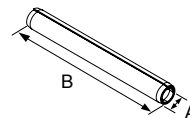

Pin Contacts for 1x4 Auxiliary Connector

Gold plated contacts are available in 3 lengths to allow sequencing of circuits.

Description	AWG	mm ²	Part Numbers	
Minimum Quantity			500	50
Standard Length 7.7mm	12	2.5	PM16P12S30	PM16P12S30-50
	16 to 14	1.0 to 1.5	PM16P1416S30	PM16P1416S30-50
	20 to 16	0.75 to 1.0	PM16P1620S30	PM16P1620S30-50
	24 to 20	0.50 to 0.75	PM16P2024S30	PM16P2024S30-50
Pre-Mate 9.3mm	12	2.5	PM16P12A30	PM16P12A30-50
	16 to 14	1.0 to 1.5	PM16P1416A30	PM16P1416A30-50
	20 to 16	0.75 to 1.0	PM16P1620A30	PM16P1620A30-50
	24 to 20	0.50 to 0.75	PM16P2024A30	PM16P2024A30-50
Post-Mate 6.4mm	12	2.5	PM16P12C30	PM16P12C30-50
	16 to 14	1.0 to 1.5	PM16P1416C30	PM16P1416C30-50
	20 to 16	0.75 to 1.0	PM16P1620C30	PM16P1620C30-50
	24 to 20	0.50 to 0.75	PM16P2024C30	PM16P2024C30-50

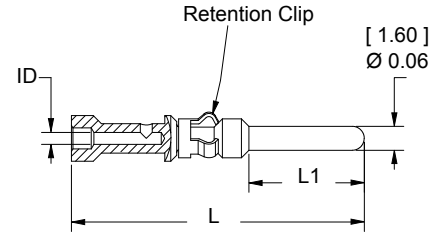

Auxiliary Pin Contact Lengths	- L -		- L1 -	
	in.	mm	in.	mm
Standard Length 7.7mm	0.77	19.6	0.30	7.7
Pre-Mate 9.3mm	0.83	21.2	0.37	9.3
Post-Mate 6.6mm	0.72	18.3	0.25	6.4

Socket Contacts for 1x4 Auxiliary Connector

Selectively gold plated contacts offer low resistance and durability up to 10,000 mating cycles.

Description	AWG	mm ²	Part Numbers	
Minimum Quantity			500	50
Socket Contact	12	2.5	PM16S12S32	PM16S12S32-50
	16 to 14	1.0 to 1.5	PM16S1416S32	PM16S1416S32-50
	20 to 16	0.75 to 1.0	PM16S1620S32	PM16S1620S32-50
	24 to 20	0.50 to 0.75	PM16S2024S32	PM16S2024S32-50

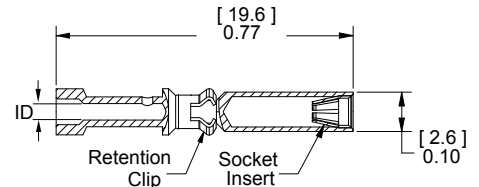

Auxiliary Socket Contacts Crimp Barrel ID		
Wire Gauge	in.	mm.
#24 / 20	0.04	1.1
#20 / 16	0.07	1.7
#16 / 14	0.08	2.1
#12	0.10	2.6

SPECIFICATIONS

Electrical

Current Rating (Amperes) ¹

Primary Contacts	230
Auxiliary Contacts	15

Operating Temperature ²

	°C	°F
PC Housing	-20° to 105°	-4° to 221°

Voltage Rating (AC/DC)

600

Dielectric Withstanding Voltage (AC)

2,200

Materials

Standard Housing	PC
Flammability Rating	UL94 V-0
Wire Power Contact	Copper alloy, silver plate
PCB Power Contact	Copper alloy, tin plate
Auxiliary Pin	Copper alloy, Au over Ni
Auxiliary Socket	BeCu, Au over Ni
Auxiliary Socket Body	Copper alloy, Sn Bright over Ni

Mechanical

	Primary Power	Auxiliary Power
Contact Wire Range	(AWG) 10 to 1/0	#24 to #12***
	(mm ²) 5.3 to 53.5	0.25 to 3.3***
MAX Wire Insulation Diameter	(in) 0.65	0.12
	(mm) 16.25	3.2
AVG Contact Resistance (milli-ohms) ³	0.136	3.00
AVG Contact Retention Force	(lbf) 60	18
	(N) 267	80
Mating Cycles (no load)	10,000	10,000
Mating Cycles (hot plug @ 120V)	250 @ 50A	250 @ 5A
Connector AVG Connect / Disconnect	(lbf) 82	
	(N) 365	

¹ Based on: 105°C rated or better cable of the largest size, Properly calibrated APP recommended tooling, and a 25°C ambient temperature.

² Limited by the thermal properties of the connector plastic housing.

³ Use APP recommended tooling only. Alternate tools may adversely affect the performance of our connectors.

TEMPERATURE CHARTS | Temperature rise charts are based on a 25°C ambient temperature.

For Temperature Rise Above 60°C, Consult the Extended Temperature Rise Charts in the Appropriate Product Section on the Website.

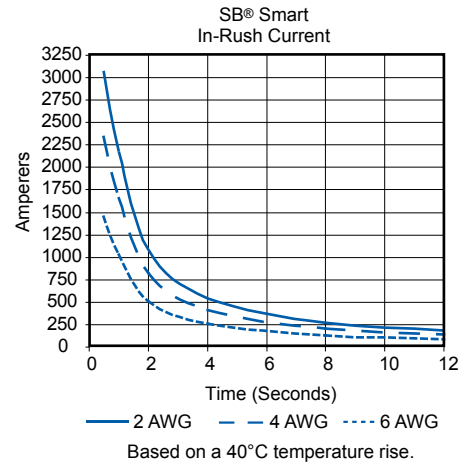
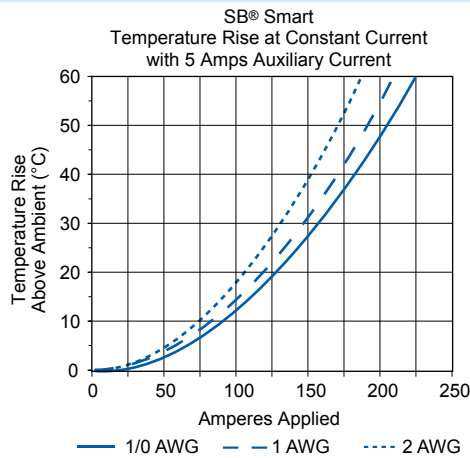
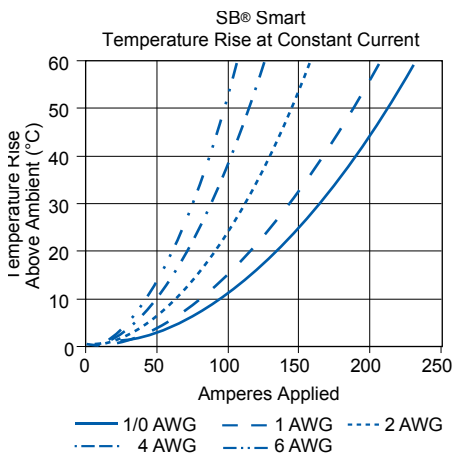

Current - Temperature Derating per IEC 60512-5-2 Test 5B

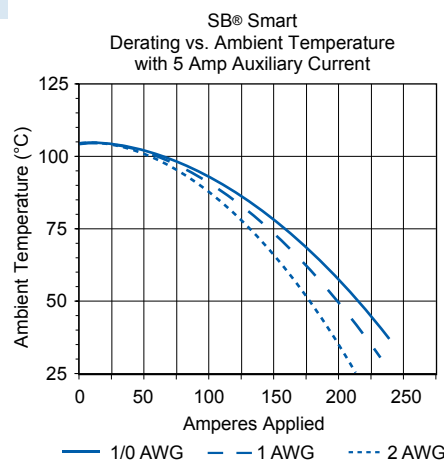
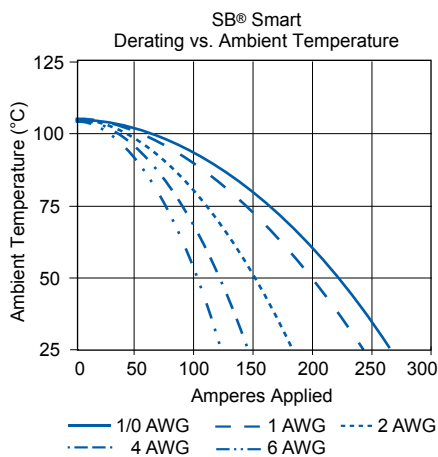

SECTION 3
SB® Smart

TOOLING INFORMATION |

Wire Size		Loose Piece Part Numbers		Loose Piece Contact Crimp Tool				
AWG	mm ²	Tin Plating	Silver Plating	Hand Tool or	Pneumatic Bench Tool	+ Die	+ Locator	Number of Crimps
1/0	53.5	N/A	1323G2	1368	1387G1	1388G3	1389G4	Single
#1	42.4		1323G1					
#2	33.6		1319					
#4	21.2		1319G4					
#6	13.3		1319G6					

NOTE: See website for the most current information.

Wire Size		Auxiliary Contact Part Number	APP Hand Tool w/ Integral Locator	Mil Std. Hand Tool* M22520/1-01	Pneumatic Tool*	Number of Crimps	Locator for: TM0001 & TP0001
#12 / 24	2.5 / 0.25	All Crimp Pins	PM1000G1	O R TM0001	O R TP0001	Single	TL0001
		All Crimp Sockets					TL0002

* TP0001 and TM0001 tools require locators TL0001 for Pins and TL0002 for Sockets.
NOTE: See website for the most current information.

Anderson™ Tooling

Why Use of Anderson™ Recommended Crimp Tooling is so Important

Our connectors are designed to achieve the highest levels of durability, reliability, and performance as shown on the connector data sheets. Crimp tooling is a critical link between the designed performance of a connector and the realization of that performance by our customers.

As part of the connector design and testing process, we recommend a number of crimp solutions that have proven to deliver the intended connector performance in a process that is repeatable. Only these solutions tested by us are listed in the conditions of acceptability from safety agencies such as UL, CSA, and TUV.













Use of tooling solutions not tested by us can affect not only performance but safety agency approvals. Problems attributable to use of non approved tools include:

Electrical and Thermal

- High electrical resistance
- Failure to realize designed current and voltage carrying capability
- Overheating
- Melting of connector housings

Mechanical

- Contacts not able to fit inside connector housings.
- Contacts not seated properly in connector housings causing: shorts, intermittent circuits, abnormally high or low mating and unmating force, & low retention force of the contact in the housing.

	PP15-45	SB®50 & PP75	SBS® Mini	SBS®	PP120, PP180, SB®, SBE®, SBX® & SBO®
<i>Detail tooling charts are available at the end of each connector family (Powerpole®, SB®, etc.).</i>					
 Press & Applicators	●	●	●		● SBE®, SBX® & SBO® Auxiliary
 1309 Series	●	●	●	●	● SBE®, SBX® & SBO® Auxiliary
 PM1000G1				● SBS®75 Auxiliary	● SBE®, SBX® & SBO® Auxiliary
 TM0001				● SBS®75 Auxiliary	● SBE®, SBX® & SBO® Auxiliary
 TP0001				● SBS®75 Auxiliary	● SBE®, SBX® & SBO® Auxiliary
 1387G1 & 1387G2		●		●	●
 1368 1368-NL					●

| 1387G1 & G2 PNEUMATIC BENCH TOOLS |

Versatile & heavy duty tools manufactured by Pico Tools, use fixed depth dies and spring bottom locators designed specifically to crimp our contacts. Dies and locators are not interchangeable between the 1387G1 and the 1387G2. These pneumatic full cycle tools operate on clean and dry shop air pressures of 80 – 125 psi (5 – 8.6 BAR). See connector family tooling charts at the end of each section for the specific dies and locators recommended for crimping each contact. Dies and locators are available from Pico Tools for a variety of other terminal types including lugs, insulated terminals, and a variety of turned pin and socket contacts.

1387G1: #12 – 2/0 (4 – 70 mm²)
Pico Tools Model 400-BHD
Compatible with M22520/23
dies and locators

1387G2: #12 – 250 mcm (4 – 120 mm²)
Pico Tools Model: 500-D



1391G1: Foot Pedal Control

TA0002: Air regulator / filter for pneumatic tools.
Keeps air clean and dry for long lasting tool performance. Dial knob adjusts air pressure going to the tool.



| 1368 SERIES HYDRAULIC TOOLS |

The dieless 4 indent head crimps full cycle until a minimum hydraulic pressure is reached. Good for crimping nearly all our contacts for wire sizes #4 – 4/0, 300mcm. The dieless system offers a highly flexible crimping system that does not require the purchase of separate dies and locators. Pressure based crimp depth allows these tools to be adapted to a broad range of large wire crimping needs including lugs, ring terminals, and splices.

1368: Hubbell VC7-SP dieless 4 indent tool with attached manual hydraulic pump. Tool includes a custom turret locator for positioning the PP120, PP180, SB®120, SB®175, SB®350 contacts. The innovative design provides two separate crimp positions for the PP180, SB®175 and SB®350 contacts. Both the tool and locator ship in black plastic carrying cases.



1368-NL: Manufactured by DMC to our specifications, this 4 indent head with attached manual hydraulic pump offers the same crimping performance as the 1368, but with the cost savings of not having a custom turret locator. Includes black plastic carrying case.



| 1309 SERIES HAND TOOLS |

High quality hand tools are designed for crimping #6 – 20 AWG (1.3 – 0.52 mm²) wires for Powerpole®, SB®, SBS®, and SBE® / SBO® connectors. The extra long bright yellow handles provide significant crimping force while minimizing operator fatigue. Full cycle ratchet mechanism makes sure every crimp is fully completed. All tools except 1309G4 include a plastic locator piece that ensures proper positioning of the contacts for crimping.

1309G2: For crimping PP15/45 loose piece strip contacts and individual contacts.
#16 – 20 AWG (1.3 – 0.5 mm²)
#12 – 20 AWG (3.3 – 1.3 mm²)

1309G3: For crimping PP15/45 loose piece strip contacts from #10 – 16 AWG (5.3 – 1.3 mm²)

1309G6: For crimping PP15/45 loose piece strip contacts from #10 – 14 AWG (6.0 – 2.1 mm²) including high strand count superflex wires.

1309G8: Includes 1 tool frame with the appropriate dies and locators to make the 1309G2, 1309G3, and 1309G6 tools. Dies and locators are color coded for easy identification and pairing. This combination allows the entire PP15/45 contact range to be crimped with one tool kit.

1309G4: For crimping PP75, SB®50, SBE®80, SBO®60, and SBS®50-75 power contacts. No locator included, follow crimp positioning specifications in assembly instructions. Tool is also used for crimping EBC auxiliary contacts.

Die & Locator Replacement Kits	
Tool	Kit
1309G2	1310G2
1309G3	1310G3
1309G6	1310G6
1309G8	1310G8
1309G4	1310G4

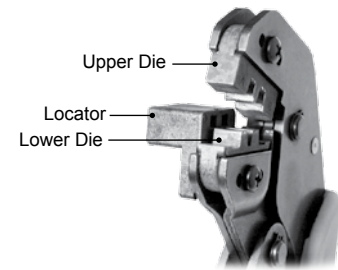

Open Barrel Contact

End of locator.

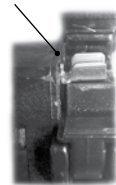

Correct

To far out from locator.

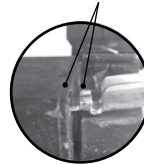

Not Correct

Closed Barrel Contact

End of locator.

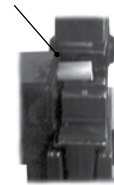

Correct

To far out from locator.

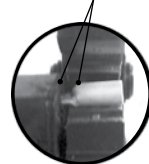

Not Correct

| PM1000G1 HAND TOOL |

Versatile 4 indent hand tool with built in multi-position turret locator. Adjustable indenter depth features 0.01 mm adjustment increments to define the perfect crimp depth for wire sizes 10 – 26 AWG (6 – 0.14 mm²). Full cycle ratchet mechanism makes sure every crimp is fully completed. Use to crimp PowerMod® contacts used as auxiliaries in SBS®75X and the 1x4 Auxiliary Connector as well as a wide range of other turned contacts including those for Power Drawer® and PPMX.



| MIL-SPEC HAND & BENCH TOOLS |

Manual hand tools and pneumatic bench tools are available in this tool series. The hand and pneumatic tools both use the same turret locators designed specifically for APP® contacts. The interchangeable nature of the turret locators allow easy upgrades from prototyping to production volumes. All tools feature adjustable indenter depths to cover #12 through 26 AWG (3.3 – 0.25 mm²) capability. Full cycle mechanism makes sure every crimp is fully completed. See tooling charts at the end of each connector section for the appropriate turret locator part numbers.

TM0001: Rugged hand tool is qualified to MIL-DTL-22520/1. DMC Model AF8. Accessories shown are purchased separately.

TP0001: Pneumatic full cycle bench tool operates on clean and dry shop air pressures of 80 – 120 psi (5 – 8.3 BAR). This DMC model WA27F is compatible with optional bench mount and foot pedal control to increase operator speed and efficiency.

TA0001: Foot pedal control for TP0001

TA0002: Air regulator / filter for pneumatic tools. Keeps air clean and dry for long lasting tool performance. Dial knob adjusts air pressure going to the tool.

TA0003: Adjustable bench mount for TP0001



TA0002

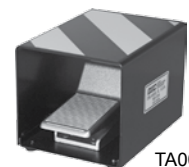

TA0001



TA0003

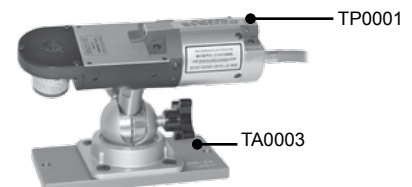

TP0001

| PRESS & APPLICATOR TOOLS |

Press and Applicator tooling is available for high volume automated or semi-automated crimp termination of our reeled contacts for up to #10 AWG or 6 mm². All applicators have been designed to meet or exceed UL requirements. See connector family tooling charts at the end of each section for the specific press, air feed kit, and applicator recommended for crimping each contact.

APP Part Number	Description
TD0101	Applicator for PP15/45 #10-20 AWG Contacts
TD0102	Applicator for PP15/45 #10-14 AWG Super Flex Contacts
TE0102	Press for Mini-Style Applicators 230V
TE0101	Press for Mini-Style Applicators 115V

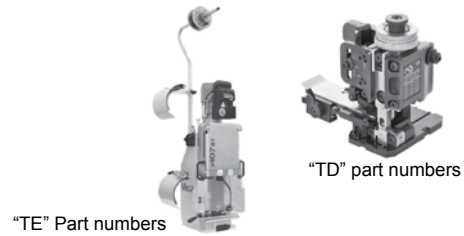

| CRIMPING TECHNICAL REFERENCE |

Crimping, Soldering, and Assembly Best Practices. Instructions for proper assembly are available for each connector and should be followed. These best practices are for reference only.

Stripping Wire Insulation

Problems with cable harness and connector systems often begin with improper or accidental cutting of wire strands when stripping wire insulation. Each strand is important, and all of them must be included in the contact barrel to avoid unnecessary hot spots during later operation. When removing insulation, position a sharp blade at a right angle and apply a steady controlled pressure cutting only the cable insulation and not the copper wire strands. Wires should be stripped to the lengths specified in the specific connector assembly instruction.

Cleaning Copper Wire

Copper oxide, a non-conductive material accumulates on copper wires exposed to oxygen and moisture. Aged and badly tarnished copper wire needs to be thoroughly cleaned to realize the rated performance of the connector and wire. Heavy oxidation can be scraped off with a stiff wire brush that penetrates the entire bundle and cleans every strand. For light surface oxidation a 3M Scotch Bright™ pad is recommended. The wires are ready for insertion into the contact barrel when they are burnished to their original bright copper finish. Contact barrels are lined with silver or tin plating to assure consistently high conductivity which will be reduced if the barrel is crimped around aged or tarnished wire.

Crimping

Our connectors are designed to achieve the highest levels of durability, reliability, and performance as shown on the connector data sheets. Crimp tooling is a critical link between the designed performance of a connector and the realization of that performance by our customers.

As part of the connector design and testing process, we recommend a limited number of crimp solutions that have proven to deliver the intended connector performance in a process that is repeatable. Only these solutions tested by us are listed in the conditions of acceptability from safety agencies such as UL, CSA, and TUV.

Use of tooling solutions not tested by us can affect not only performance but also safety agency approvals. Problems attributable to use of tools not recommended include:

Electrical and Thermal

- High electrical resistance
- Failure to realize designed current and voltage carrying capability
- Overheating
- Melting of connector housings

Mechanical

- Contacts not able to fit inside connector housings.
- Contacts not seated properly in connector housings causing: shorts, intermittent circuits, abnormally high or low mating and unmating force, & low retention force of the contact in the housing

Soldering

The alternative to crimping is to solder all cable strands within the contact barrel. When using an open flame, make sure that you are not in an area where explosive gasses are present. The right proportion of solder is essential if this procedure is employed.

Use a quality 60/40 solder (60 percent tin, 40 percent lead) in wire form with a rosin flux core. Cable strands should be separately fluxed with rosin paste, and the contact should be held in a vise with the barrel end facing up. Apply heat to the outside of the barrel while the solder flows in beside the wire strands.

Here are some things to avoid when soldering:

- A. Don't use too much solder, to the point that it flows out of the contact barrel.
- B. Don't allow flux or solder on the outside of the contact. This will interfere with contact mounting within the installation or with the contact connection to a mating connector.
- C. Don't overheat and cause excessive solder to "wick" up into the cable and stiffen it. This could interfere with contact flexibility when connectors are mated.
- D. Don't solder when contact is in the connector housing. Solder away from the housing and then insert the contact into the housing after it has cooled.

NOTE: Underwriters Laboratories (UL) requires the use of a cable clamp for soldered connections to unsupported wires.

| DETERMINING IF A GOOD CRIMP HAS BEEN MADE |

1. Assure the correct wire size and type is used for the specific contact being crimped.
2. Follow the assembly instructions for the connector. Special attention should be paid to wire preparation and stripping.
3. Use the correct application tooling we recommend (tool, die, & locator).
4. Make several crimps for testing, and record crimp dimensions in both "x" and "y" planes.
5. Test the electrical resistance across a mated pair of connectors to the standard of the information provided on the data sheet.
 - a. The electrical resistance values should be similar to (or less than) what we publish for that connector in our catalogs. Please see the "Avg. Mated Contact Resistance" on the data sheet for the specific connector.
6. Test the pull out strength per the table to the right.
 - a. To achieve the electrical performance published in our literature the pull out values at minimum should meet the UL 486A values for the wire size being used. The first column (lower value) pull out is the minimum per UL486A. The second column is what APP tries to achieve when designing our crimp solutions. Any force within this range is acceptable.
7. If crimps are within electrical and mechanical specifications then the crimp dimensions are suitable to be used as a secondary inspection criteria.

Wire Size AWG or MCM	Lbf Contact Retention Force Range	kgf Contact Retention Force Range
22	8 - 12	3.6 - 5.4
20	13 - 16	5.9 - 7.3
18	20 - 30	9.1 - 13.6
16	30 - 40	13.6 - 18.1
14	50 - 60	22.7 - 27.2
12	70 - 85	31.8 - 38.6
10	80 - 125	36.3 - 56.7
8	90 - 180	40.8 - 81.6
6	100 - 200	45.4 - 90.7
4	140 - 280	63.5 - 127
3	160 - 320	72.3 - 145.1
2	180 - 360	81.6 - 163.3
1	200 - 400	90.7 - 181.4
1/0	250 - 500	113.4 - 226.8
2/0	300 - 600	136.1 - 272.2
3/0	350 - 700	158.8 - 317.5
4/0	450 - 775	204.1 - 351.5
250	500 - 800	226.8 - 362.9
300	550 - 800	249.5 - 362.9

| WHY CRIMP DIMENSIONS ARE NOT SUITABLE AS PRIMARY INSPECTION CRITERIA |

Crimp dimensions are not an adequate or reliable means to evaluate if a good crimp has been made. For this reason they should not be relied upon as a primary inspection method.

When you crimp a contact, the material is forced down to the size of the fully closed die. This die closure on most tools is a fixed dimension. When the die is released, the material (contact and wire) will expand back out when they are no longer restrained by the die. The amount that it expands outwards or “bounces back” is dependant on the resistance or force that the material in the contact and wire places against the crimp die. The resistance of the material to being formed by the crimp will vary with wire type and stranding, hardness of the metal (both contact and wire), as well as the temperature. It is for this reason that the crimp height is a variable and cannot be relied upon solely to determine if a crimp is good or not.

| CRIMP DIMENSIONS AS SECONDARY INSPECTION CRITERIA |

Crimp dimensions should only be used as secondary inspection criteria due to the above variables. These variables make it impossible for us to determine what the correct crimp dimension should be without evaluation of the specific instance. Accordingly harness manufacturers are responsible for determining the appropriate crimp dimensions to be used and only as a secondary inspection method. Crimp dimensions are an acceptable means of short interval inspection for determining homogeneity within a batch provided:

1. Electrical resistance and pull out strength are tested on samples from the batch to ensure the crimp dimensions are indicative of a good crimp.
2. The same tooling is used throughout the batch and operated in the same manner, at the same calibration level.
3. The same wire is used throughout the batch. (Wire can vary significantly by factors ranging from class to manufacturer).
4. Assembly instructions are closely followed, especially wire stripping and preparation.

| OTHER CRITICAL CRIMP DIMENSIONS |

There are other critical crimp dimensions that impact if a crimp is good or not. All contacts are designed to work with a specific crimping solution to minimize the distortion of crimping force on the critical geometries of the contact. If the incorrect crimp solution is used or the correct crimp solution is improperly used, then this will distort the intended geometries of the contact.

The geometry of the contact blade and its relative angle to the crimp barrel must be maintained after the contact is crimped. If these dimensions are not maintained the contact will not latch properly in the housing. This can impact how well the contact is secured in the housing as well as the normal force (measurement of the opposing force that pushes the contacts together) between the mating blades of two mating contacts. The normal force is directly related to the electrical properties of the connector and poor normal force can lead to higher electrical resistance, overheating, and reduced current capability. These geometries can only be assured by using the correct crimp tool, with proper die and locator.

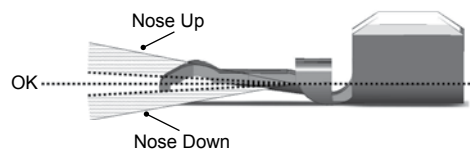

Part Number Page Reference

P/N	Page #	P/N	Page #	P/N	Page #
902	78	6358	98, 104	115G23-BK	24
906	82	6361	98	115G2-BK	24
907	82, 86	6362	98	115G3	24
908	82, 86	6394	98, 104	115G3-BK	24
910	82, 86	104G17	64, 70	115G4	24
911	84	105G1	97	115G4-BK	24
912	82	105G13	89	115G7	24
913	82	105G3	80	115G7-BK	24
914	82	105G8	80, 94	115G8	24
916	82, 86	106G6	85, 103	115G8-BK	24
917	82, 86	106G7	84, 101	120BBS	73, 106
919	85	110G10	24	1303G12	47, 86, 104
931	82	110G12	30	1303G13	47, 86
932	82	110G16	29	1303G17	104
940	77	110G17	29	1303G2	104
941	77	110G18	38, 46	1303G3	86
942	77	110G19	38, 42	1303G8	104
943	77	110G20	42, 46	1304G13	104
945	80	110G21	30	1304G28	104
949	77	110G34	78	1304G31	86
990	65, 71	110G50	25	1304G32	47, 86
992	67	110G51	25	1304G34	104
1307	33, 47, 68, 86	110G54	33, 68, 73, 106	1304G35	104
1309	109	110G55	44, 78	1304G36	104
1319	39, 47, 73, 86, 106, 108	110G56	44, 78	1307-BK	33, 68
1321	39	110G59-BK	102	1309G2	47, 54, 104, 111
1327	20, 89, 95, 101	110G68	30	1309G3	47, 54, 111
1331	21, 47, 54, 89, 95, 101, 104	110G73	83	1309G4	47, 66, 86, 104, 111
1332	21, 47, 54, 101, 104	110G9	24, 21, 97	1309G6	47, 111
1347	43, 47, 78, 86	110G9-BK	24, 21, 97	1309G8	47, 54, 104, 111
1348	43, 47, 78, 86	111038G2	47	1310G2	111
1368	47, 86, 104, 108, 109, 110	111812P16	106	1310G3	111
1381	43	111812P5	29	1310G4	111
1382	43, 47, 78, 86	111812P6	38, 46	1310G6	111
1383	43, 47, 78, 86	111812P7	38, 42	1310G8	111
1384	43, 47, 78, 86	111812P8	42, 46	1317G1	21
5648	46, 81, 97, 103	111961P1	103	1317G11	21
5663	46, 81, 97, 103	111961P2	97	1317G11-BK	21
5687	46, 81, 97, 103	113715P4	89	1317G12	21
5690	46, 81, 97, 103	113716P3	89	1317G12-BK	21
5693	46, 81, 97, 103	113890P1	65, 71	1317G13	21
5900	33, 47, 68, 86	113890P2	81	1317G13-BK	21
5905	65, 71	113890P3	84	1317G1-BK	21
5910	38, 66, 71, 91	113899P1	64, 70, 76	1317G2	21
5912	38, 66, 71, 91	113952P1	89	1317G2-BK	21
5913	38, 66, 71, 91	113953P1	89	1317G3	21
5915	33, 47, 68, 86	114411P1	37	1317G3-BK	21
5916	32	114411P2	37	1317G4	21
5918	85, 103	114411P3	37	1317G4-BK	21
5919	42, 76, 106	114555P1	30	1319-BK	39, 73, 106
5920	42, 76, 97, 103, 106	114555P10	30	1319G4	39, 47, 73, 106, 108
5921	42, 76, 106	114555P2	30	1319G4-BK	39, 73, 106
5952	33, 47, 68, 86	114555P3	30	1319G6	39, 47, 73, 86, 106, 108
5953	33, 47, 68, 86	114555P6	30	1319G6-BK	39, 73, 106
6339	98	114555P7	30	1321-BK	39
6344	89, 95	114555P9	30	1321G1	39
6350	98	115158G1	105	1321G1-BK	39
6351	98	115158G2	105	1321G2	39
6352	98	115158G4	105	1321G2-BK	39
6353	98	115G1	24	1321G3	39
6354	98, 104	115G1-BK	24	1321G3-BK	39
6355	98, 104	115G2	24	1321G4	39
6356	98, 104	115G23	24	1321G4-BK	39

Part Number Page Reference

P/N	Page #	P/N	Page #	P/N	Page #
1321G8	39	1340G3-BK	59	1399G1-BK	29
1321G8-BK	39	1341G1	99, 104	1399G2	29
1323G1	39, 47, 73, 86, 106, 108	1341G1-BK	99	1399G20	37
1323G1-BK	39, 73, 106	1341G2	99, 104	1399G20-BK	37
1323G2	39, 47, 106, 108	1341G2-BK	99	1399G21	37
1323G2-BK	39, 106	1341G3	99, 104	1399G21-BK	37
1327-BK	20	1341G3-BK	99	1399G23	37
1327FP	20	1347-BK	43, 78	1399G23-BK	37
1327FP-BK	20	1348-BK	43, 78	1399G2-BK	29
1327G16	20	134G1	65, 71	1399G6	29
1327G16-BK	20	134G2	81, 84, 76	1399G6-BK	29
1327G16FP	20	1368-NL	109, 110	1399G7	37
1327G16FP-BK	20	1377G1	21	1399G7-BK	37
1327G17	20	1377G11	21	1399G8	29
1327G17-BK	20	1377G11-BK	21	1399G8-BK	29
1327G18	20	1377G12	21	1399G9	29
1327G18-BK	20	1377G12-BK	21	1399G9-BK	29
1327G21	20	1377G13	21	1424266-1	54
1327G21-BK	20	1377G13-BK	21	1441G1	30
1327G22	20	1377G1-BK	21	1442G1	30
1327G22-BK	20	1377G2	21	1460G1	23
1327G23	20	1377G2-BK	21	1460G1-BK	23
1327G23-BK	20	1377G3	21	1460G2	23
1327G5	20	1377G3-BK	21	1460G23	24
1327G5-BK	20	1377G4	21	1460G23-BK	24
1327G5FP	20	1377G4-BK	21	1460G2-BK	23
1327G5FP-BK	20	1381-BK	43	1460G3	23
1327G6	20, 89, 95, 101	1381G1	43	1460G3-BK	23
1327G6-BK	20	1381G1-BK	43	1460G4	23
1327G6FP	20	1381G2	43	1460G4-BK	23
1327G6FP-BK	20	1381G2-BK	43	1461G1	23
1327G7	20	1381G3	43	1461G1-BK	23
1327G7-BK	20	1381G3-BK	43	1461G2	23
1327G7FP	20	1381G4	43	1461G2-BK	23
1327G7FP-BK	20	1381G4-BK	43	1461G3	23
1327G8	20	1382-BK	43, 78	1461G3-BK	23
1327G8-BK	20	1383-BK	43, 78	1462G1	29
1327G8FP	20	1384-BK	43, 78	1462G2	29
1327G8FP-BK	20	1385458-1	54	1462G3	29
1328G1	43, 47	1385519-1	54	1463G1	38
1328G1-BK	43	1385520-1	54	1463G2	38
1328G2	43, 47	1387G1	47, 66, 86, 104, 108, 109, 110	1464G1	42
1328G2-BK	43	1387G2	47, 86, 104, 109, 110	1464G2	42
1331-BK	21, 54	1388G3	47, 86, 104, 108	1465G1	46
1332-BK	21, 54	1388G4	47, 86, 108	1465G2	46
1335G1	22	1388G6	47, 66, 86, 104	1466G1	64
1336G1	22	1388G7	47, 66, 86, 104	1467G1	75
1337G1	22	1389G20	66	1470G1	24
1339G1	87, 104	1389G21	47	1470G1-BK	24
1339G1-BK	87	1389G3	47, 86, 104	1470G2	24
1339G2	59, 66	1389G4	47, 86, 104	1470G2-BK	24
1339G2-BK	59	1389G6	47, 86	1470G3	24
1339G3	59, 66	1389G7	86	1470G3-BK	24
1339G3-BK	59	1389G9	66, 104	1470G4	24
1339G4	87, 104	1391G1	29, 110	1470G4-BK	24
1339G4-BK	87	1399G10	29	1725900-2	54
1339G5	59, 66	1399G10-BK	29	180BBS	44, 78
1339G5-BK	59	1399G13	29	180BBS-BK	44, 78
1340G1	59, 66	1399G13-BK	29	1827G1	20
1340G1-BK	59	1399G14	29	1827G1-BK	20
1340G2	59, 66	1399G14-BK	29	1830G1	21
1340G2-BK	59	1399G17	29	1830G1-LPBK	21, 47
1340G3	59, 66	1399G17-BK	29	1830G2	21

Part Number Page Reference

P/N	Page #	P/N	Page #	P/N	Page #
1830G2-LPBK	21, 47	2-8171G7	98	5916G16-BK	32
1836G1	22	2-8171G8	98	5916G4	32
1875G1	33, 47	2-8171G9	98	5916G4-BK	32
1875G1-BK	33	2-8675P1	102	5916G5	32
1875G2	33, 47	2-8675P2	96	5916G5-BK	32
1875G2-BK	33	3-5074P1	80, 84, 94, 101	5916G6	32
1875G3	33, 47	3-5074P3	80, 84, 94, 101	5916G6-BK	32
1875G3-BK	33	3-5074P5	80, 84, 94, 101	5916G7	32
20-01	25	350BBS	83	5916G7-BK	32
200G1L	21	3-5798P1	91, 96, 102	5918-BK	85, 103
200G1L-LPBK	21, 47	3-5911P1	22	5919-BK	42, 76, 106
200G3L	21	3-5912P1	22	5920-BK	42, 76, 97, 103, 106
200G3L-LPBK	21, 47	3-5913P1	22	5921-BK	42, 76, 106
201G1H	21	3-5952P1	22	5927G6	33
201G1H-LPBK	21, 47	3-5956P1	90, 95, 101	5927G6-BK	33
2-5048	78	3-6018P1	106	5952-BK	33, 68
2-5049	78	3-6034P1	76	5953-BK	33, 68
26-01	25	3-6034P1-BK	76	6305G1	101
261G1	21, 54	3-6035P1	76	6310G1	101
261G1-LPBK	21, 47, 54	3-6035P1-BK	76	6354-BK	98
261G2	21, 54	3-6036P1	81	6355-BK	98
261G2-LPBK	21, 47, 54	3-6036P1-BK	81	6356-BK	98
261G3	21, 54	3-6037P1	81	6358-BK	98
261G3-LPBK	21, 47, 54	3-6037P1-BK	81	6380G1	92
262G1	21, 54	3-6054P1	71	6381G1	92
262G1-LPBK	21, 47, 54	3-6054P1-BK	71	6382G1	92
262G2	21, 54	3-6054P2	71	6383G1	92
262G2-LPBK	21, 47, 54	3-6054P2-BK	71	6384G1	92, 104
269G1	21	3-6055P1	71	6384G1-BK	92
269G1-LPBK	21, 47	3-6055P1-BK	71	6384G2	92, 104
269G2	21	3-6055P2	71	6384G2-BK	92
269G2-LPBK	21, 47	3-6055P2-BK	71	6385G1	92
269G3	21	440G1	101	6390G1	92
269G3-LPBK	21, 47	440G2	101	6394-BK	98
27-01	25	440G3	101	6396G1	91, 96, 102
2-7249G1	98	441G1	90, 95	6810G1	72
2-7249G2	98	441G2	90, 95	6810G1-BK	72
2-7249G3	98	441G3	90, 95	6810G2	72
2-7249G4	98	444G1	90, 95, 101	6810G2-BK	72
2-7249G5	98	4802G3	90, 91, 96, 102, 104	6810G3	72
2-7249G6	98	4802G3-BK	91, 96, 102	6810G3-BK	72
2-7249G7	98	4803G3	90, 91, 96, 102, 104	75BBS	33, 68
2-7250G8	82	4803G3-BK	91, 96, 102	75LOKBLK	32
2-7251G1	92	4827G6	90, 96, 102	75LOKBLK-BK	32
2-7251G2	92	4827G6-BK	90, 96, 102	75LOKBLU	32
2-7251G3	92	4850G6	90, 96, 102	75LOKBLU-BK	32
2-7251G4	92	5648-BK	46, 81, 97, 103	75LOKGRA	32
2-7251G5	92	5663-BK	46, 81, 97, 103	75LOKGRA-BK	32
2-7251G7	92	5687-BK	46, 81, 97, 103	75LOKGRN	32
2-7252G11	77	5690-BK	46, 81, 97, 103	75LOKGRN-BK	32
2-8170G1	92	5693-BK	46, 81, 97, 103	75LOKRED	32
2-8170G14	92	5900-BK	33, 68	75LOKRED-BK	32
2-8170G2	92	5905-BK	65, 71	75LOKSMTBLU	37
2-8170G3	92	5910-BK	38, 66, 71, 91	75LOKSMTBLU-BK	37
2-8170G4	92	5912-BK	38, 66, 71, 91	75LOKWHT	32
2-8170G5	92	5913-BK	38, 66, 71, 91	75LOKWHT-BK	32
2-8170G7	92	5915-BK	33, 68	75LOKWNGBLU	37
2-8171G1	98	5916-BK	32	75LOKWNGBLU-BK	37
2-8171G2	98	5916G14	32	75LOKWNGBLU-R	37
2-8171G3	98	5916G14-BK	32	75LOKWNGBLU-R-BK	37
2-8171G4	98	5916G15	32	906-BK	82
2-8171G5	98	5916G15-BK	32	907-BK	82
2-8171G6	98	5916G16	32	908-BK	82

Part Number Page Reference

P/N	Page #	P/N	Page #	P/N	Page #
910-BK	82	ASMFP30-2X1-KR	22	P5916G5-BK	32
911G2	100	ASMFP30-2X1-RK	22	P5916G7-BK	32
912-BK	82	ASMFP30-2X2-KRWE	22	P6810G1	72
913-BK	82	ASMFP30-2X2-WEKR	22	P6810G1-BK	72
914-BK	82	ASMFR45-1X2-KR	22	P6810G3	72
916-BK	82	ASMFR45-1X2-RK	22	P6810G3-BK	72
917-BK	82	ASMFR45-1X3-KER	22	P906	82
919G1	85	ASMFR45-1X3-KEW	22	P906-BK	82
922G1	85	ASMFR45-2X1-KR	22	P913	82
923G1	81	ASMFR45-2X1-RK	22	P913-BK	82
924G1	81	ASMFR45-2X2-WEKR	22	P940	77
931-BK	82	ASMFV45-1X2-KR	22	P940-BK	77
932-BK	82	ASMFV45-1X2-RK	22	P949	77
940-BK	77	ASMFV45-2X1-KR	22	P949-BK	77
941-BK	77	ASMFV45-2X1-RK	22	P992	67
942-BK	77	ASMP30-1X2-KR	22	P992-BK	67
943-BK	77	ASMP30-1X2-RK	22	P992G1	67
945G2	94	ASMP45-1X2-KR	22	P992G1-BK	67
945G3	80	ASMP45-1X2-RK	22	P992G2	67
945G3-BK	80	ASMPV45-1X2-KR	22	P992G2-BK	67
946G1	80	ASMPV45-1X2-RK	22	PC5930S	33, 68
946G1-BK	80	B00229P1	85	PC5930S-BK	33, 68
949-BK	77	B00511G2	97	PC5930T	33, 68
969P1	104	B00511G4	103	PC5930T-BK	33, 68
970P1	104	B01915P1	33, 68	PC5933S	34, 68
981G1	75	B01997P1	73, 106	PC5933S-BK	34, 68
981G2	75	B01998P1	83	PC5933T	34, 68
990-BK	65, 71	B02019P1	76	PC5933T-BK	34, 68
990G1	65, 71	B02265G1	53	PC5934S	34, 68
990G1-BK	65, 71	B02265G2	53	PC5934S-BK	34, 68
990G2	65, 71	B02265G3	53	PC5934T	34, 68
990G2-BK	65, 71	B02265G4	53	PC5934T-BK	34, 68
992-BK	67	BAT-G1	105	PC-HSG-PP	38
992G1	67	BMHSG-P	25	PC-HSG-PP-BK	38
992G1-BK	67	BMHSG-R	25	PC-HSG-SB	71
992G2	67	BMPP10-45R	25	PC-HSG-SB-BK	71
992G2-BK	67	CHRG-G4	105	PCSTAPLE-2	38
992G4	67	E6336	98	PM1000G1	66, 104, 108, 109, 111
992G4-BK	67	E6339	98	PM1002G1	66, 104
992G5	67	E6349	98	PM1003G1	66, 104
992G5-BK	67	E6350	98	PM1003GX	66
992G6	67	E6351	98	PM16P12A30	59, 90, 95, 101, 107
992G6-BK	67	E6352	98	PM16P12A30-50	101, 107
992G7	67	E6353	98	PM16P12C30	59, 90, 95, 101, 107
992G7-BK	67	E6361	98	PM16P12C30-50	101, 107
993G1	103	E6362	98	PM16P12S30	59, 90, 95, 101, 107
993G2	97	E6380G1	92	PM16P12S30-50	59, 90, 95, 101, 107
994G1	103	E6381G1	92	PM16P1416A30	59, 90, 95, 101, 107
994G2	97	E6382G1	92	PM16P1416A30-50	101, 107
995G1	80, 94	E6383G1	92	PM16P1416C30	59, 90, 95, 101, 107
995G1-APP	94	E6385G1	92	PM16P1416C30-50	101, 107
995G2	84, 101	E6390G1	92	PM16P1416S30	59, 90, 95, 101, 107
995G2-APP	101	E6392G1	92	PM16P1416S30-50	59, 90, 95, 101, 107
995G3	80, 94	H1120P42	89	PM16P1620A30	59, 90, 95, 101, 107
995G3-APP	94	H1120P43	76	PM16P1620A30-50	101, 107
995G4	84, 101	H1120P55	64, 70	PM16P1620C30	59, 90, 95, 101, 107
995G4-APP	101	H1216P7	44, 78	PM16P1620C30-50	101, 107
996G1	84	H1216P8	33, 68, 73, 106	PM16P1620S30	59, 90, 95, 101, 107
997G1	65, 70, 76	H1216P9	83	PM16P1620S30-50	59, 90, 95, 101, 107
ASMFP30-1X2-KR	22	H1507P38	29	PM16P2024A30	59, 90, 95, 101, 107
ASMFP30-1X2-RK	22	H1835P3	91, 97, 103	PM16P2024A30-50	101, 107
ASMFP30-1X3-KER	22	P5916-BK	32	PM16P2024C30	59, 90, 95, 101, 107
ASMFP30-1X3-KEW	22	P5916G4-BK	32	PM16P2024C30-50	101, 107

Part Number Page Reference

P/N	Page #	P/N	Page #
PM16P2024S30	59, 90, 95, 101, 107	SBS50RED-BK	57
PM16P2024S30-50	59, 90, 95, 101, 107	SBS50WHT	57
PM16S12S32	59, 90, 96, 102, 107	SBS50WHT-BK	57
PM16S12S32-50	59, 90, 96, 102, 107	SBS75GBLK	58
PM16S1416S32	59, 90, 96, 102, 107	SBS75GBLK-BK	58
PM16S1416S32-50	59, 90, 96, 102, 107	SBS75GBLU	58
PM16S1620S32	59, 90, 96, 102, 107	SBS75GBLU-BK	58
PM16S1620S32-50	59, 90, 96, 102, 107	SBS75GBRN	58
PM16S2024S32	59, 90, 96, 102, 107	SBS75GBRN-BK	58
PM16S2024S32-50	59, 90, 96, 102, 107	SBS75GHDLRED	65
PSBS50BLK	57	SBS75GPRBLK-BK	58
PSBS50BLK-BK	57	SBS75GWHT	58
PSBS50BLU	57	SBS75GWHT-BK	58
PSBS50BLU-BK	57	SBS75XBLK	58
PSBS50BRN	57	SBS75XBLK-BK	58
PSBS50BRN-BK	57	SBS75XBRN	58
PSBS50GRA	57	SBS75XBRN-BK	58
PSBS50GRA-BK	57	SBS75XPRBLK-BK	58
PSBS50GRN	57	TA0001	111
PSBS50GRN-BK	57	TA0002	110, 111
PSBS50RED	57	TA0003	111
PSBS50RED-BK	57	TD0101	54, 112
PSBS75XBLK	58	TD0102	112
PSBS75XBLK-BK	58	TE0101	54, 112
PSBS75XCLP1	65	TE0102	54, 112
PSBS75XCLP1-BK	65	TL0001	66, 104, 108
PSBS75XCLP2	65	TL0002	66, 104, 108
PSBS75XCLP2-BK	65	TL0005	104
PSBS75XGRN-BK	58	TM0001	66, 104, 108, 109, 111
SB120-HDL-RED	76	TP0001	66, 104, 108, 109, 111
SB175-LOCKOUT	81	VEH-G2	105
SB350-LOCKOUT	85		
SB50-HDL-RED	70		
SBE80CLPRED	89		
SBE80GRA	87		
SBE80GRA-BK	87		
SBE80HDLRED	89		
SBE80ORN	87		
SBE80ORN-BK	87		
SBE80RED	87		
SBE80RED-BK	87		
SBE80YEL	87		
SBE80YEL-BK	87		
SBO60CLPRED	89		
SBO60HDLRED	89		
SBO60ORN	87		
SBO60ORN-BK	87		
SBO60RED	87		
SBO60RED-BK	87		
SBO60WHT	87		
SBO60WHT-BK	87		
SBO60YEL	87		
SBO60YEL-BK	87		
SBS50BLK	57		
SBS50BLK-BK	57		
SBS50BLU	57		
SBS50BLU-BK	57		
SBS50BRN	57		
SBS50BRN-BK	57		
SBS50GRA	57		
SBS50GRA-BK	57		
SBS50-HDL-RED	64		
SBS50RED	57		

Environmentally Sealed SPEC Pak® Connectors

Featuring Powerpole® Connector Technology



- Environmentally Sealed, IP68, Shells
- UV and Chemical Resistant Ruggedized Shells
- 15 to 310 Amps per Contact
- Utilizes Powerpole® 15 - 180 Connectors
- Latching and Locking Features
- Customer Configurable

Additional APP® Products

Saf-D-Grid®



- Touch Safe Plug and Receptacle
- High Voltage AC and DC
- Integral Latch
- IEC320 C14 Drop In Replacement

PowerMod®HP



- Touch Safe Female Side
- Hot Pluggable, Low Resistance
- Latching, Panel Mount and Busbar

Euro Battery Connector / DIN Style



- Euro Battery Connector (EBC), Fully Compatible with DIN 43589-1 Connectors
- "A" Series DIN Style Connector For American Wire Gauge (AWG)

HEADQUARTERS

Anderson Power Products®
13 Pratts Junction Road
Sterling, MA 01564-2305 USA
T: 978-422-3600
F: 978-422-0128

EUROPE

Anderson Power Products® Ltd.
Unit 3 Europa Court
Europa Boulevard
Westbrook, Warrington
Cheshire, WA5 7TN United Kingdom
T: +44 (0) 1925 428390
F: +44 (0) 1925 520203

ASIA / PACIFIC

IDEAL Anderson Asia Pacific Ltd.
Unit 922-928, Topsail Plaza
11 On Sum Street
Shatin N.T., Hong Kong
T: +[852] 2636 0836
F: +[852] 2635 9036

CHINA

IDEAL Anderson Technologies (Shenzhen) Ltd.
Block A8, Tantou Western Industrial Park
Songgang, Baoan District
Shenzhen, P.R. China 518105
T: +[86] 755 2768 2118/3393 2388
F: +[86] 755 2768 2218

TAIWAN

IDEAL Anderson Asia Pacific Ltd.
Taiwan Branch, 4F.-2, No.116
Dadun 20th St., Situn District
Taichung City 407, Taiwan (R.O.C.)
T: +[886] 4 2310 6451
F: +[886] 4 2310 6460



Your Best Connection

An IDEAL Company

2018-0054 CAT-PPMP REV 06

VISIT US AT WWW.ANDERSONPOWER.COM

