

METAL FINISHING MACHINES

MS
MAQUINAS

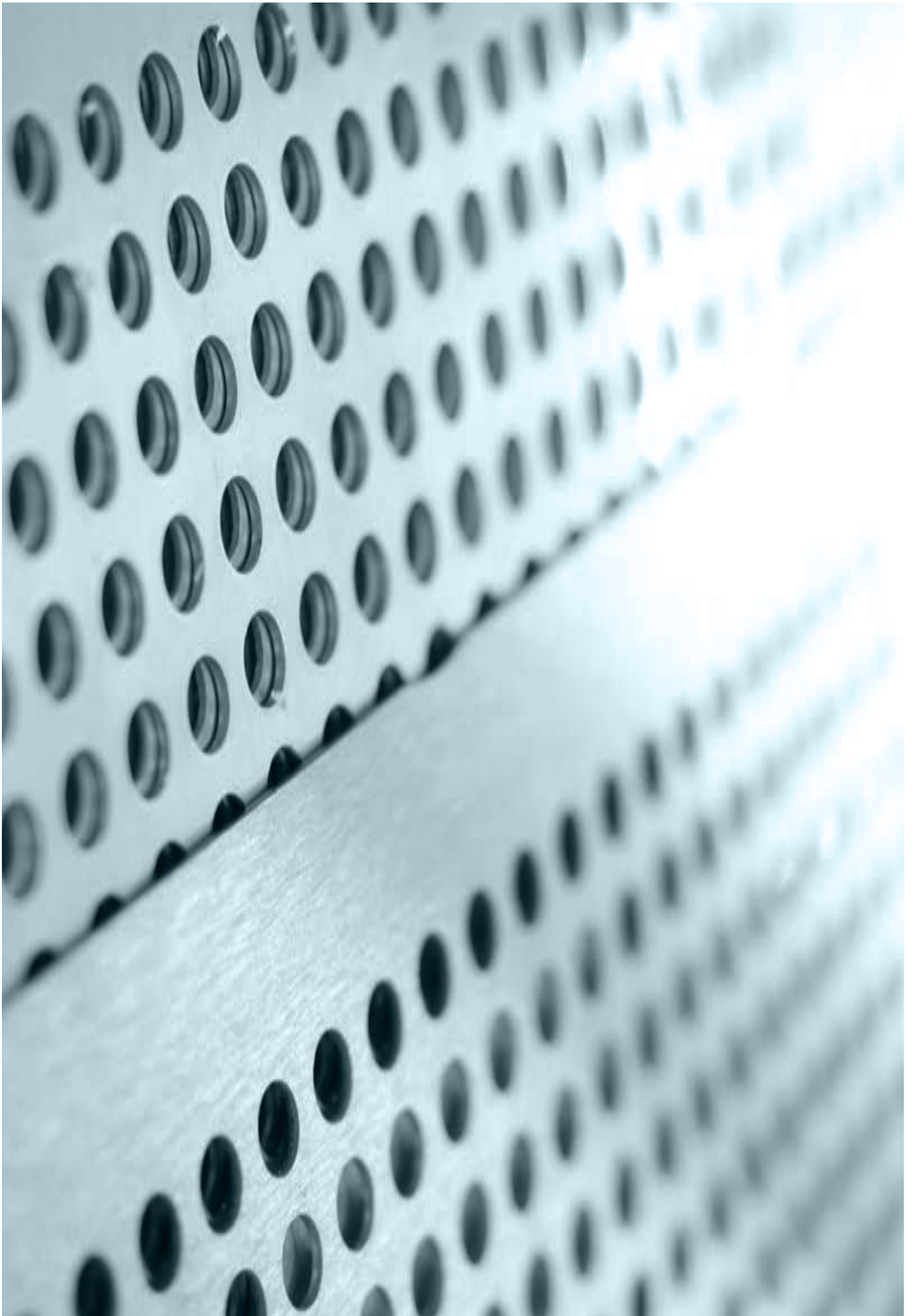

NS Máquinas is a specialized manufacturer of machines for the metal finishing and polishing industry located in Portugal.

Through the years NS Máquinas has been bringing unique features and designs both to tube and sheet metal fabricators.

This has been made possible by continual investment in research and development and to a constant pursuit of optimal and flexible solutions.

Today NS is capable of creating and offering machines which combine quality and adequacy for diverse production requirements.

Enjoying Surface Finishing

CONTENTS

1 ROUND TUBE FINISHING MACHINES	05
2 RECTANGULAR TUBE AND BAR FINISHING MACHINES	13
3 DEBURRING MACHINES	23
4 MIRROR POLISHING MACHINES	33
5 OTHER BELT FINISHING MACHINES AND EQUIPMENT	39

Quality you can trust

COUNTING WITH VAST EXPERIENCE



3000

machines produced



Since 2003

Strong metal finishing know-how

INVESTING IN THE FUTURE



Automation

Development of automatic tube and metal sheet loading, unloading and return systems



Solid

Quality you can trust



Products

More than 100 products



Innovation

Constant innovation: 5 new machines launched in the last 2 years

Producing machines for the most demanding markets.

"We put all of our machines through a grueling pace throughout a day" [...]

A lot of them are running 24/7 and we haven't had any problem with them at all."

Kevin Harding, Camdel Metals Corporation, USA, about ML100 3Z

Adequate machines for each application from the small workshop to the continuous production lines.

This flat grinder is a fantastic machine. We are all so impressed by the speed and also with the high quality of finish. We have a number of clients who are using us for the polishing service, so I hope the machine will pay for itself very soon."

Jimmy Mills, Sparcraft, South Africa, about FG170 ZK



SUPPLYING A COMPLETE OFFER



Growth

Sustainable sales growth



60 Countries

global presence in more than 60 countries



Technical Service

Quick field and online technical service



High Skilled

25% of workforce with university degree



Customized

Customized solutions



Testing

Test center

"Thanks to the team from NS. You've done a job that you should be very proud of and sets a new standard in bar grinding quality...I'm very honored to be part of the project..."

Corey Munn, AusTech Supplies, Australia, about FGW150 2Z HD

Achieving the requested deburring or finishing quality is a process NS Máquinas is experienced in. Counting with a vast range of machines and abrasive options, our team is committed to join and provide you the optimum solution for your surface finishing problem.



MAX.
DIAMETER



No.
OF STATIONS



STRAIGHT
TUBE



WET
COOLING



BENT
TUBE

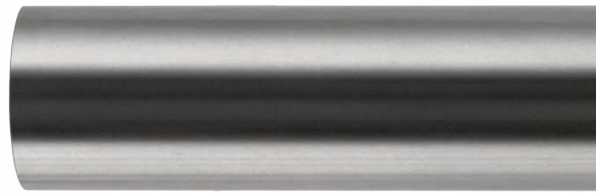

**ML PLANETARY SYSTEM:
ABRASIVE BELT
FINISHING WITHOUT
ROTATING THE TUBE. LOW
HEAT AND NO VIBRATION
ON THE TUBE**

**SUPERIOR QUALITY IN
SATINISING AND FINISHING
OF ROUND TUBES AND
PIPES. ULTIMATE
VERSATILITY FOR OVAL,
DRILLED, TAPERED AND
BENT TUBES**

**AUTOMATIC LOADING
AND UNLOADING SYSTEMS
FOR AUTONOMOUS
OPERATION**

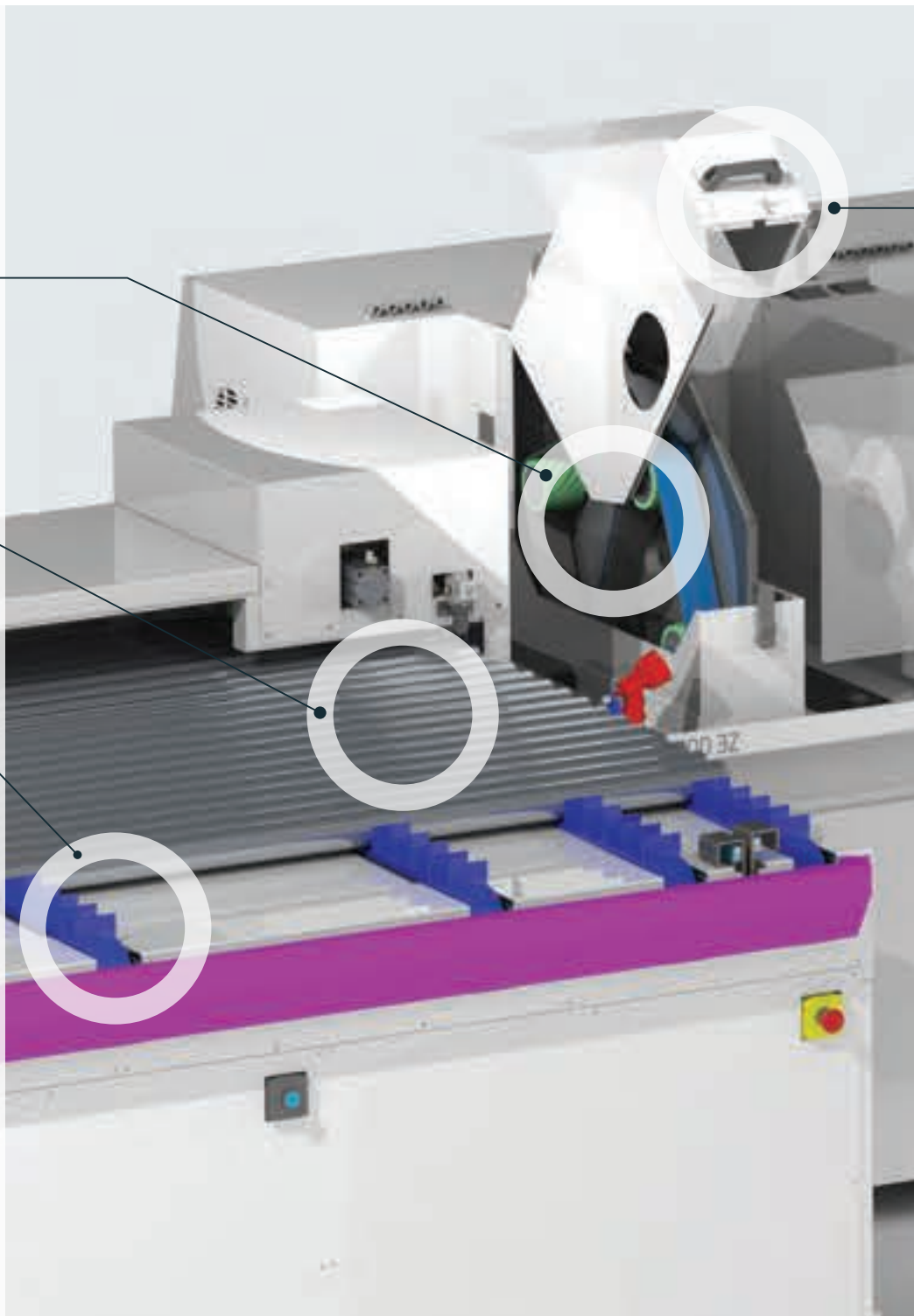

1

ROUND TUBE FINISHING MACHINES

SINGLE OR MULTIPLE
STATION DESIGN: 1 UP TO
6 UNITS (6Z)

DIFFERENT DIAMETER
CAPACITIES UP TO
Ø310MM

MACHINES AVAILABLE IN
DRY AND IN WET
CONFIGURATIONS (WITH
MANUAL OR AUTOMATIC
WATER COOLING AND
FILTRATION SYSTEM)

MOBILE TOUCHSCREEN
FOR EASY MACHINE
CONTROL WITH OPTION
FOR PROGRAMS SAVING

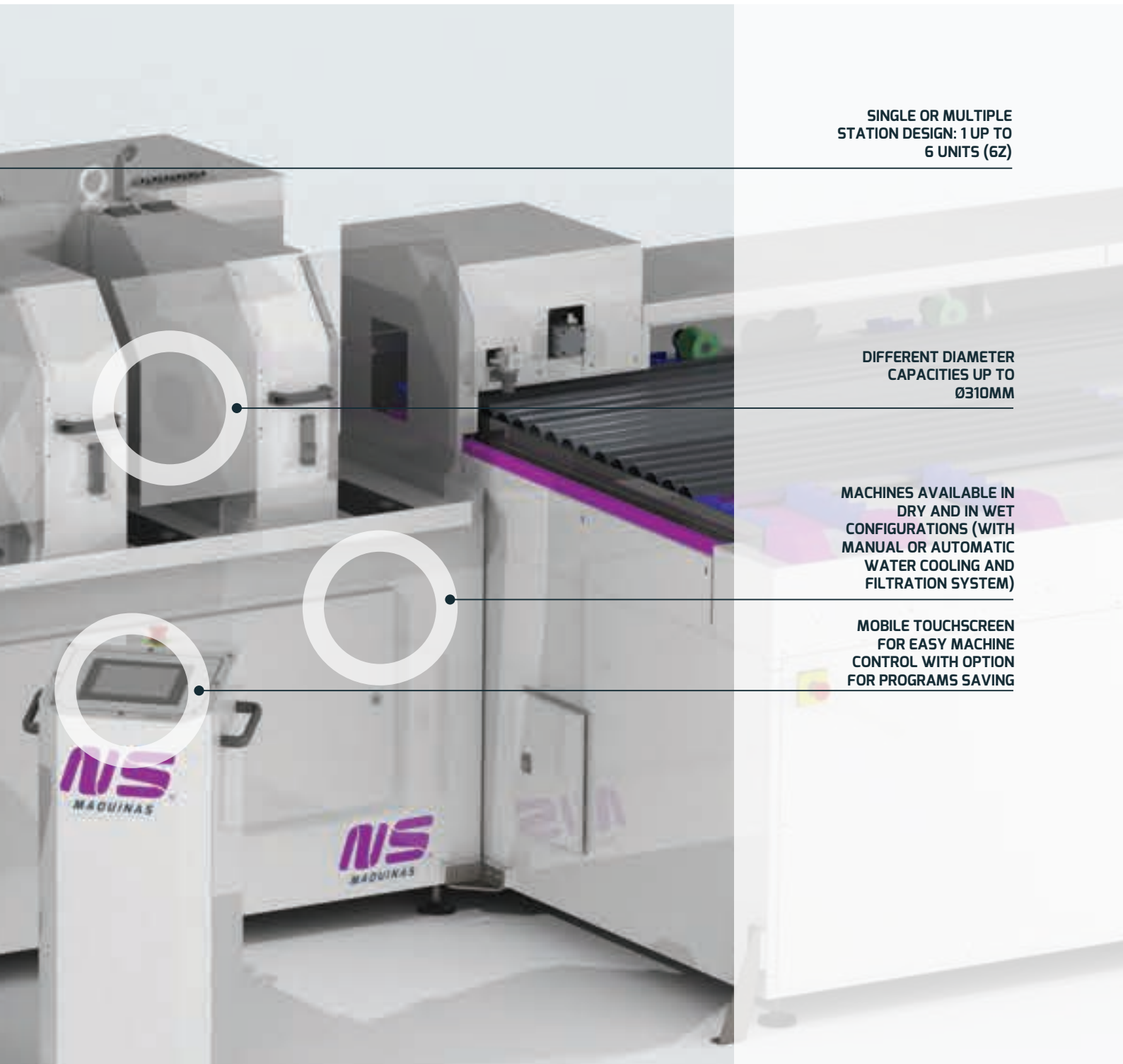

ML100



Minimum tube vibration even on the longest lengths



Straight or curved tubes polishing



Available with touchscreen for programs saving



ML50



Finishing of tubes with very tight bends such as taps



Compact design for the highest flexibility in curved shapes



Finishing steel tubular furniture products after bending process



ML75

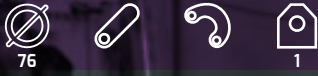

Finishing tight curved tubes with diameters up to Ø76mm



Designed for curved tubes finishing, it can be also fitted with automatic feeding systems for straight tubes finishing



ML200



Large diameter tube finishing (up to Ø150mm: ML150 or Ø205mm: ML200)



Finishing of large diameter curved tubes with maximum consistency



ML100 3Z



Multiple stations machines: final finishing in one single pass



Abrasive belts open and close automatically with photocells



Double station machine available (ML100 2Z)



ML300



Finishing with maximum quality and safety on high diameters up to Ø310mm



Pressure roller system for higher belt grinding capacity. Possible to finish tube surface but also to remove imperfections by using contact pressure on the abrasive belt





MLW100



Wet cooling system reduces temperature of the tubes during finishing operation and keeps potentially explosive dusts wet, avoiding related risks



Manual or automatic filtration systems available



MLW200



Large diameter tube wet finishing (up to Ø205mm) with no vibration even on the longest lengths



MLW200 TC – Model dedicated to conic tubes finishing



Feeding system easily slides out for curved tubes operation



MLW100 6Z AT



114



2-6



AUTOMATIC TUBE SYSTEMS



Final finishing in one single pass. Different designs up to 6 stations



Automatic loading and unloading systems with option for programs saving



Automatic Bundle Loading System: Designed up to 5 tons maximum load



Great savings in handling time and operator intervention



MLW100 3Z: Standard 3 stations round tube wet finishing machine

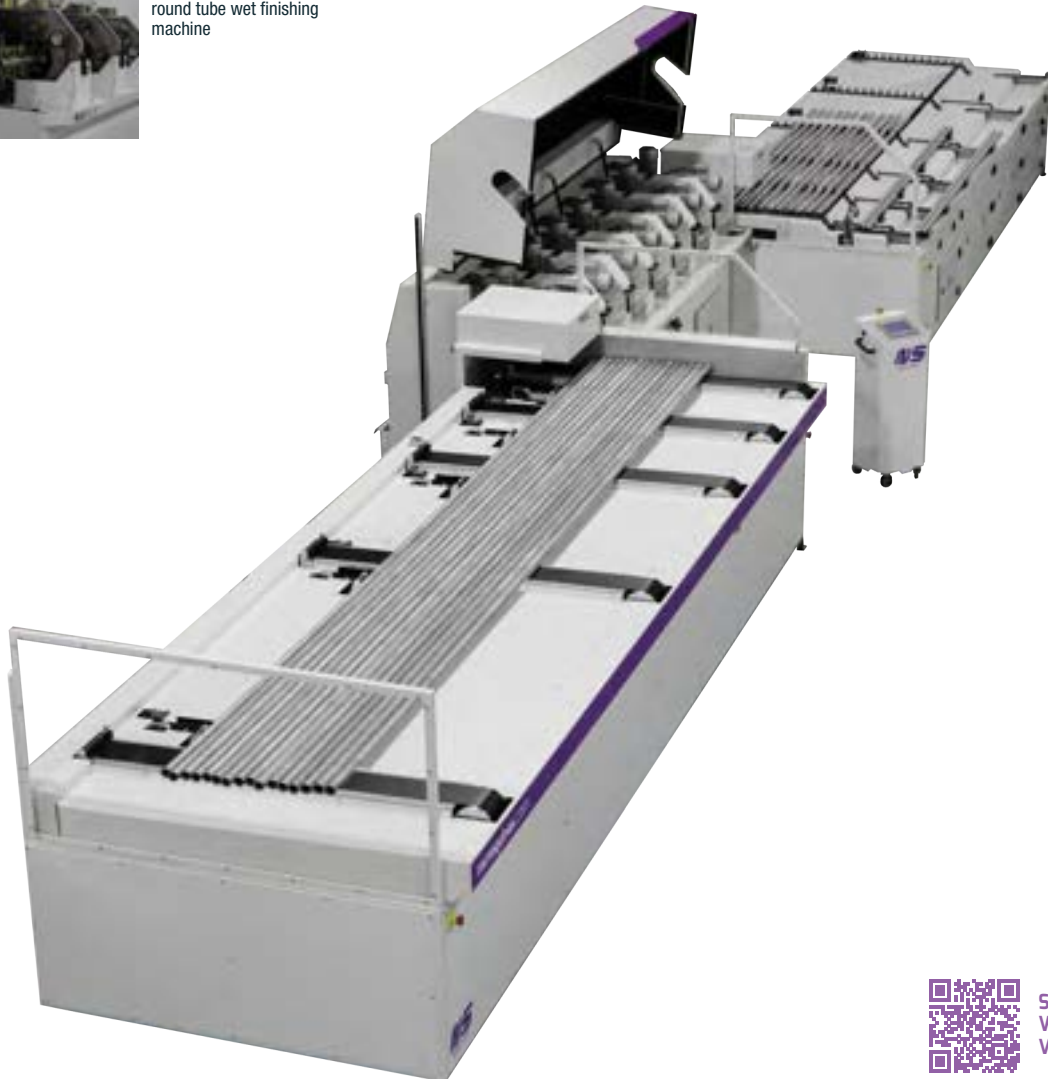

SCAN TO WATCH THE VIDEO ▶

Technical Details

	ML100	ML50	ML75	ML150	ML200
Working capacity (Ømm)	10-114	5-51	10-76	20-150	20-205
No. Stations	1	1	1	1	1
Abrasive belts dimensions (mm)	(2x) 940x50	(2x) 500x25	(2x) 860x25	(2x) 1100x50	(2x) 1240x70
Abrasive belts speed (m/s) *	10-25	10-25	10-25	10-25	10-25
Feeding speed (m/min)	1-5	Manual	1-5	1-4	1-4
Abrasive belts motor (kW)	3	2.2	2.2	5.5	7.5
Wheel motor (kW)	1.5	1,5	1.5	2.2	3
Feeding motor (kW)	(2x) 0.12	-	(2x) 0.12	(2x) 0.18	(2x) 0.18
Total Power (kW)	5	4	4	8	11
Consumption (A)	14	12	13	18	24
Dust extractor conection (Ømm)	80	60	80	100	100
Dimensions (mm)	750x1000x1300	650x740x1220	750x1000x1300	1100x950x1350	1150x950x1350
Weight (kg)	250	170	230	480	680

	ML300	ML100 3Z	MLW100	MLW200	MLW100 6Z
Working capacity (Ømm)	40-310	10-114	10-114	20-205	10-110
No. Stations	1	3	1	1	6
Abrasive belts dimensions (mm)	(2x) 2150X120	(3x) (2x) 940X50	(2x) 940X50	(2x) 1240x70	(6x) (2x) 940x50
Abrasive belts speed (m/s)*	10-25	10-25	10-25	10-25	10-25
Feeding speed (m/min)	0.6-3	1-5	1-5	1-4	1-5
Abrasive belts motor (kW)	11	(3x) 3	3	7.5	(6x) 3
Wheel motor (kW)	4	(3x) 1.5	1.5	4	(6x) 1.5
Feeding motor (kW)	(2x) 0.25	(4x) 0.12	(2x) 0.12	(2x) 0.37	(7x) 0.12
Total Power (kW)	17	14	5	13	34
Consumption (A)	35	33	14	28	60
Dust extractor conection (Ømm)	200	(3x) 80	-	-	-
Dimensions (mm)	1700X1610X1800	950X1450X1350	1380x1060x1480	2200x2500x1600	3500x3000x1900
Weight (kg)	1950	600	550	1430	3012

* with variable speed

1350 MAX. WIDTH

4 SIDES FINISHING

WET COOLING

1 SIDE FINISHING

No. ABRASIVE BELT STATIONS
1-4

TOP AND BOTTOM FINISHING

No. ABRASIVE BRUSH STATIONS
1-4



BELT (Z) OR BRUSH (K) OPTIONS DISPLAYED IN VARIABLE SEQUENCES

POSSIBILITY TO EQUIP WITH TRANSFER AND CONVEYOR RETURN SYSTEM FOR SMALL PARTS OPERATION

MACHINES AVAILABLE IN DRY AND IN WET CONFIGURATIONS (WITH MANUAL OR AUTOMATIC WATER COOLING AND FILTRATION SYSTEM)

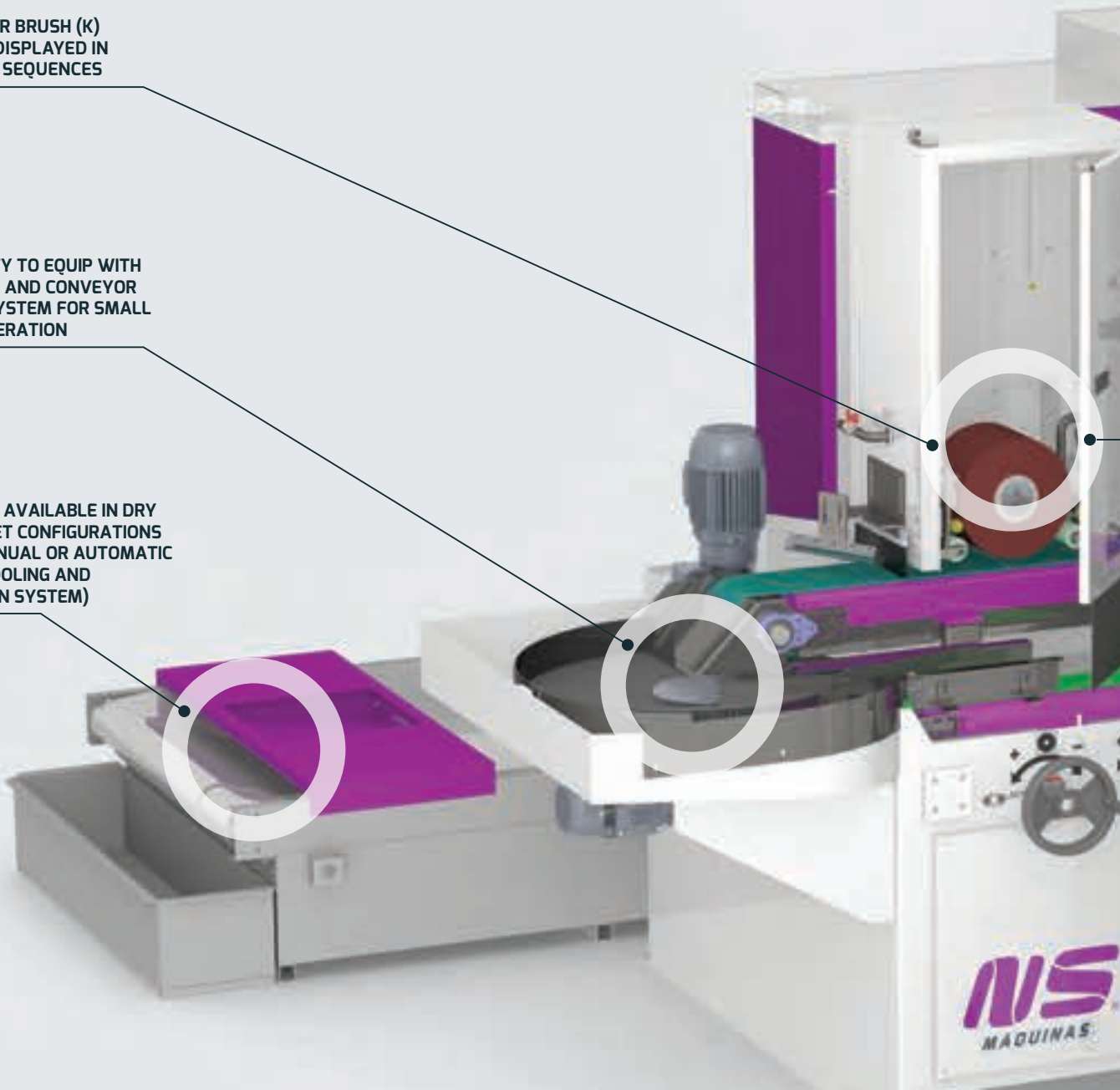

2

RECTANGULAR TUBE AND BAR FINISHING MACHINES

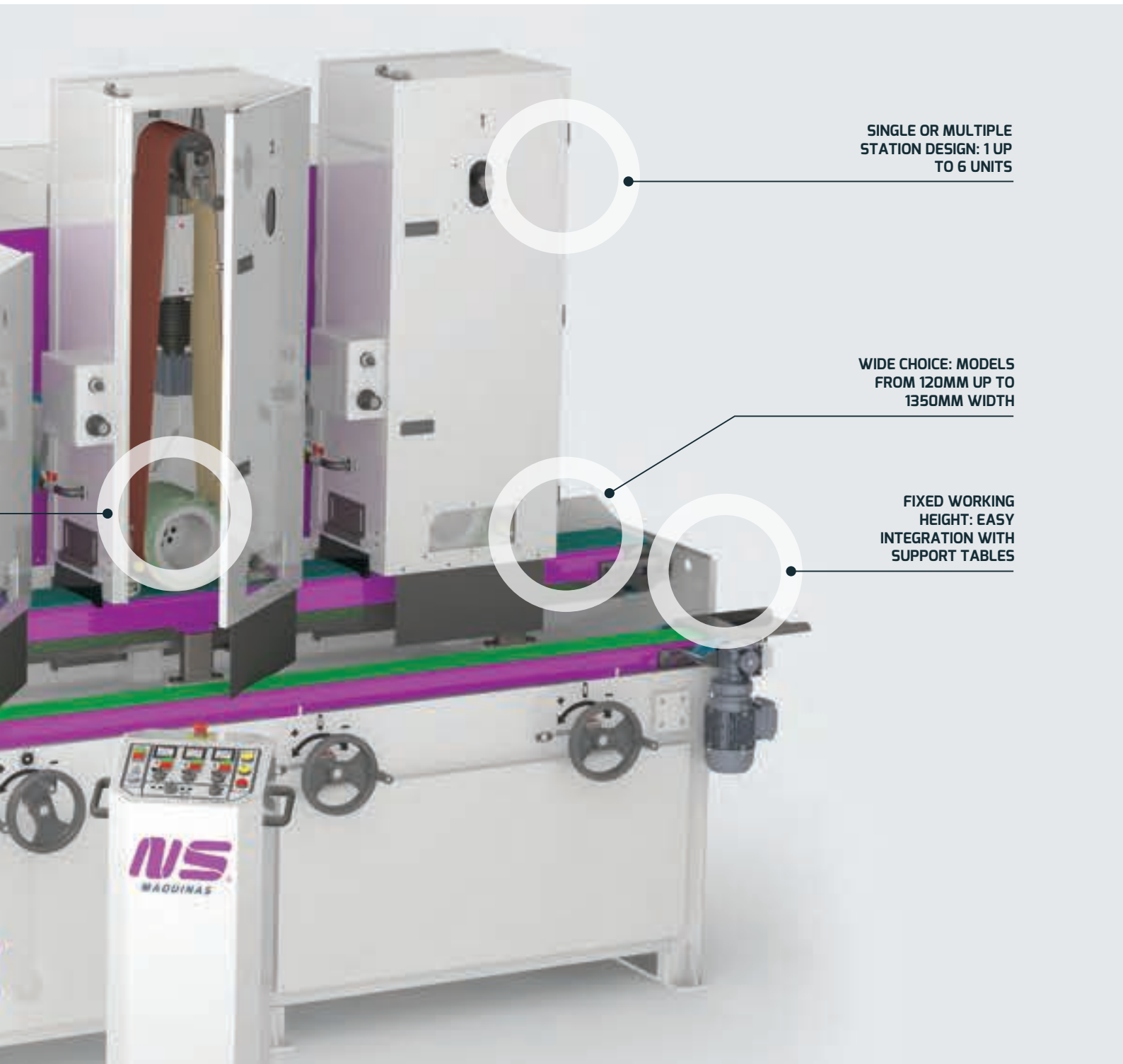

SINGLE OR MULTIPLE
STATION DESIGN: 1 UP
TO 6 UNITS

WIDE CHOICE: MODELS
FROM 120MM UP TO
1350MM WIDTH

FIXED WORKING
HEIGHT: EASY
INTEGRATION WITH
SUPPORT TABLES

MS
MACHINAS

FG170 2ZK





170



1-2



0-1

Different machine configurations with capacity up to 170mm (FG170) or 220mm (FG220)



2 and 3 stations available: belt and brush (ZK) and double belt and brush (2ZK)



Fixed working height enables to connect loading and unloading tables



FC120 ZK



Compact machine for simple operation for flat bars and rectangular tubes



Thickness meter for accurate pressure adjustments





FG220 4ZV



Upper and lower
abrasive stations:
Double side finishing
of bars and tubes
in one single pass

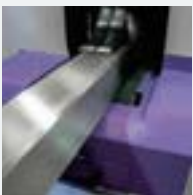

FG330 2ZK



Capacity of 330mm
working width



Abrasive belt automatic
oscillation for perfect
tracking



FGW170 3Z



Different working widths capacity: 170mm and 220mm



Manual or automatic water filtration system



Air blower for tubes drying after the last abrasive station

FGW330 3Z HD



Stainless steel tubes, bar stock and metal sheet belt grinding and finishing



Independent abrasive stations construction: accurate setting



FGW170 4ZV



FGW170 4ZV: Top and bottom finishing of tubes, bars and aluminum profiles in one single pass

FGW170 8Z: Finishes all four sides simultaneously

Touch screen panel for automatic regulation with programs saving feature

FGW170 2ZKR



Automatic return of small parts



TR120



SIDE GRINDING MACHINE



Before and after side grinding



Angled grinding heads for upper and lower 45° beveling



Option: counter rotating lamella brushes available for edge rounding after side grinding

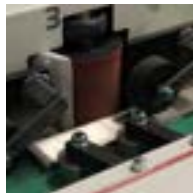

Side grinding stations with vertical oscillation for uniform wear of abrasive belts



Single adjustment with side pressure roller system: constant pressure along the complete bar



Double side bars finishing up to 6 grinding stations





DM1100 2ZK

METAL SHEET FINISHING MACHINE



Possibility to have upgraded control panel with programs saving mode



Double or triple abrasive belt station plus finishing brush (2ZK and 3ZK)



Quick abrasive belt replacement

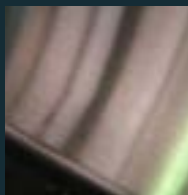
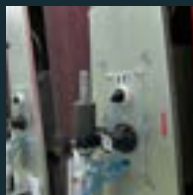

Consistent and smooth surface finishing



Brush unit with option to be used with oscillation (150 strokes/min)



DMW660 ZZ

660
1100



METAL SHEET WET FINISHING MACHINE



Independent stainless steel compartments for each finishing station



660mm and 1100mm maximum width models



Integrated filtering and pumping system



Technical Details

	FC120	FG170	FG220	FG220 4ZV	FG330	TR120
Working capacity (mm)	120x120	170x200	220x200	220x200	330x200	300x25
No. belt stations (Z)	1	1-2	1-2	4	1-2	1-3
No. brush stations (K)	0-1	1	1-2	-	1	0-1
Abrasive belt dimensions (mm)	120x1850	170x2000	220x2200	220x2200	330x2200	120x1850
Abrasive brush dimensions (mm)	120xØ200	170xØ200	220xØ200	-	330xØ200	(2x) 30xØ250
Abrasive belt speed (m/s)	20	20	20	20	20	20
Abrasive brush speed (m/s)	15	15	15	-	15	18
Feeding speed (m/min)	12	6+12	6+12	6+12	6+12	6
Abrasive belt motor per head (kW)	3	4	5.5	5.5	7.5	3
Abrasive brush motor per head (kW)	1.5	3	4	-	5.5	(2x) 0.25
Feeding motor (kW)	0.37	0.45	0.45	(3x) 0.25	0.55	0.37
Total Power (kW)	5 ⁽¹⁾	8 ⁽¹⁾	10 ⁽¹⁾	23	14 ⁽¹⁾	11 ⁽²⁾
Consumption (A)	12 ⁽¹⁾	18 ⁽¹⁾	22 ⁽¹⁾	44	30 ⁽¹⁾	24 ⁽²⁾
Dust extraction connection (Ø mm)	(2x) 80 ⁽¹⁾	(2x) 95 ⁽¹⁾	(2x) 100 ⁽¹⁾	(4x) 100	(2x) 100 ⁽¹⁾	(3x) 100 ⁽²⁾
Dimensions (mm)	1450x850x1800 ⁽¹⁾	1700x1000x2000 ⁽¹⁾	1700x1250x2000 ⁽¹⁾	3750x1350x2150	1750x1400x2050 ⁽¹⁾	2175x2100x1260 ⁽²⁾
Weight (kg)	500 ⁽¹⁾	750 ⁽¹⁾	950 ⁽¹⁾	2240	1100 ⁽¹⁾	1220 ⁽²⁾

	FGW170	FGW220	FGW330	DM1100 2ZK	DMW660 2Z	DMW1100 2Z
Working capacity (mm)	170x200	220x200	330x200	1100x120	660x120	1100x120
No. belt stations (Z)	1-6	1-6	1-6	2	2-6	2-6
No. brush stations (K)	0-2	0-2	0-2	1	-	-
Abrasive belt dimensions (mm)	170x2000	220x2200	330x2200	(2x) 1100x2200	660x2200	1100x2200
Abrasive brush dimensions (mm)	170xØ200	220xØ200	330xØ250	1120xØ200	-	-
Abrasive belt speed (m/s)	20	20	20	20	20	20
Abrasive brush speed (m/s)	15	15	15	15	-	-
Feeding speed (m/min)	6+12	6+12	6+12	4-15	4-15	4-15
Abrasive belt motor per head (kW)	4	5.5	7.5	18.5	11	18.5
Abrasive brush motor per head (kW)	3	4	5.5	9.2	-	-
Feeding motor (kW)	0.45	0.75	0.75	0.37	0.37	0.45
Total Power (kW)	9 ⁽³⁾	12 ⁽³⁾	16 ⁽³⁾	49	25	40
Consumption (A)	15 ⁽³⁾	25 ⁽³⁾	30 ⁽³⁾	97	50	85
Dust extraction connection (Ø mm)	-	-	-	(3x) 150	-	-
Dimensions (mm)	2100x1100x2200 ⁽³⁾	2100x1150x2200 ⁽³⁾	2100x1300x2200 ⁽³⁾	2230x2210x2205	2650x2310x2450	2750x2800x2450
Weight (kg)	1250 ⁽³⁾	1300 ⁽³⁾	1450* ⁽³⁾	4200	4100	5200

⁽¹⁾ Values for ZK version

⁽²⁾ Values for 3Z version

⁽³⁾ Values for 2Z version

1600 MAX. WIDTH

DEBURRING STATION

ABRASIVE BRUSH STATION

1 SIDE FINISHING

CROSS BELTS

2 SIDES FINISHING

PLANETARY BRUSHES



EDGE ROUNDING UNIT BOTH FOR SMALL AND LARGE PARTS WITH ABRASIVE CROSS BELTS (C) OR WITH PLANETARY BRUSHES (PK)

SINGLE AND DOUBLE SIDED CONFIGURATIONS

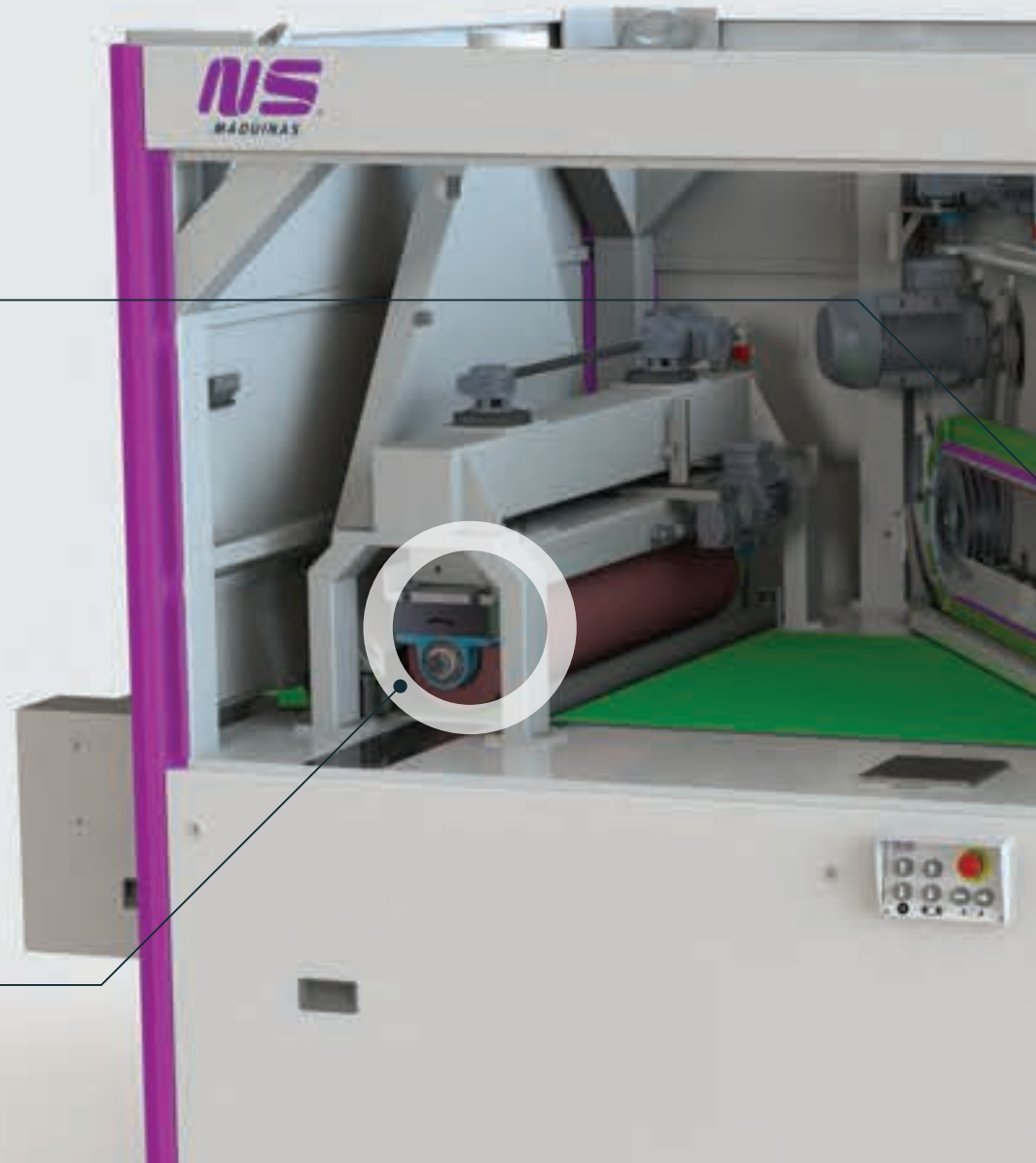

FINAL SURFACE FINISHING WITH OSCILLATING BRUSH (K) OR WITH NON-WOVEN WIDE BELT (Z)

3

DEBURRING MACHINES

DEBURRING HEAVY OR LIGHT BURRS, DROSS AND SLAG AFTER LASER, PLASMA, SHEARING OR PUNCHING WITH WIDE BELT CONTACT ROLLER (Z) OR WITH DEBURRING DRUM (D)

USER FRIENDLY OPERATING PANEL WITH EASY KEYS AND INTEGRATED TOUCHSCREEN

DIFFERENT WORKING WIDTHS AVAILABLE FROM 660MM UP TO 1600MM

FIXED WORKING HEIGHT IN EVERY MULTIPLE HEAD CONFIGURATION



DM1100 C



EDGE ROUNDING MACHINE



Strong edge rounding



Perfect linear finishing on the complete surface of the part



Two abrasive cross belts operating in opposite directions



Removing oxide layer with wire brushes cross belts



Small parts processing down to 50x50mm



Edge rounding of parts with protective film without touching the finished surface



TRUMPF
TruLiner 3020



DM1600 C

EDGE ROUNDING MACHINE



Larger working capacity
up to 1600mm width



Rounding edges of thick
plate steel parts



PARTS RETURN SYSTEM



Ideal for small parts
when processing both
sides top and bottom



Easy to remove and
store

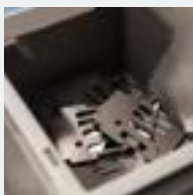

Continuous flow of parts
with single operator



DM1100 2C



DOUBLE SIDED EDGE ROUNDING



Top and bottom edge rounding of laser, waterjet or punched parts

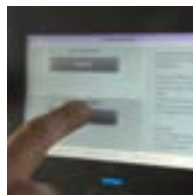

Easy abrasives replacement: automatic positioning of upper and lower cross belts



Single sided small parts processing down to 50x50mm thanks to additional conveyor and support table





DM1100 ZC

DEBURRING AND EDGE ROUNDING MACHINE



Deburring station combined with two edge rounding cross belts

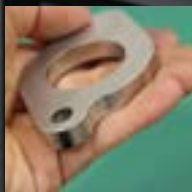

Easy access for cleaning and maintenance all around the machine



Before and after laser cut parts deburring and edge rounding



DM1350 ZC: 1350mm width table allows to deburr or finish wider metal sheets



DM1100 Z2C



DEBURRING AND DOUBLE SIDED EDGE ROUNDING MACHINE



Upper deburring and edge rounding station



Large deburring drum as alternative to remove heavy burrs and slag

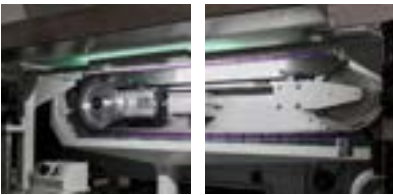

Lower edge rounding station



Parts return system



Deburring with wide abrasive belt and double sided edge rounding with cross belts



Small parts processing option





DM1100 DC

THICK STEEL PLATES DEBURRING AND EDGE ROUNDING MACHINE



Deburring drum for thick plasma and flame cut deslagging and deburring



Smooth edges with a radius from two counter rotating abrasive cross belts

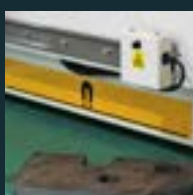
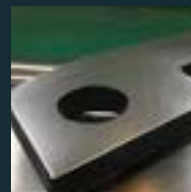

Conveyor belt width 1100mm with integrated 600mm magnetic hold down for small parts processing. Automatic material thickness measurement

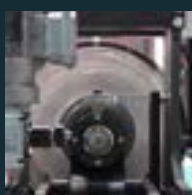

Floating drum adjusts to material distortion and thickness tolerances. The drum oscillates to improve abrasive lifetime and deslagging results



SCAN TO
WATCH THE
VIDEO ▶

AUTOMATIC TRANSPORT SYSTEMS



Long and heavy parts automatic process: feed, transfer, and return



180 degrees automatic conveyor tables



SCAN TO WATCH THE VIDEO ▶

DM660 ZPK



DEBURRING AND EDGE ROUNDING MACHINE



Deburring unit and planetary double brush station for edge rounding



Large radius on heavy plate parts even in internal contours



Technical Details

	DM1100 C	DM1600 C	DM1100 2C	DM1100 DC
Working capacity (mm)	1100x50	1600x50	1100x50	1100x120
No. contact drum stations	-	-	-	1
No. cross belt stations	1	1	2	1
Abrasive paper dimensions (mm)	-	-	-	1150x1520
Contact drum speed (rpm)*	-	-	-	185-650
Cross belt speed (m/s)*	2-8	2-8	2-8	2-8
Feeding speed (m/min)	0.6-3.2	0.6-3.2	0.6-3.2	0.5-4.0
Contact drum motor (kW)	-	-	-	11
Cross belt motor (kW)	(2x) 3	(2x) 4	(4x) 3	(2x) 3
Feeding motor (kW)	0.18	0.12	(3x) 0.18	0.37
Total Power (kW)	6	8	13	19
Consumption (A)	18	13	30	40
Dust extraction connection (Ø mm)	150	150	196	(2x) 150
Dimensions (mm)	2213x1530x1940	2730x1740x1940	2560x1980x2150	2258x2900x2220
Weight (kg)	1200	1790	2250	4100

	DM1100 ZC	DM1100 Z2C	DM1100 ZCK	DM660 ZPK
Working capacity (mm)	1100x120	1100x120	1100x120	660x120
No. belt stations	1	1	1	1
No. cross belt stations	1	2	1	-
No. brush stations	-	-	1	1
Abrasive belt dimensions (mm)	1100x2200	1100x2200	1100x2200	660x2200
Abrasive brush dimensions (mm)	-	-	1120xØ200	(2x) 800xØ350xØ100
Abrasive belt speed (m/s)*	8-22	8-22	8-22	8-22
Cross belt speed (m/s)*	2-8	2-8	2-8	-
Abrasive brush speed (m/s)*	-	-	8-18	6-31
Feeding speed (m/min)	0.9-13	0.6-3.2	0.9-13	0.4-12
Abrasive belt motor per head (kW)	18.5	18.5	18.5	11
Cross belt motor (kW)	(2x) 3	(4x) 3	(2x) 3	-
Abrasive brush motor per head (kW)	-	-	9.2	(2x) 2.2
Feeding motor (kW)	0.37	(3x) 0.18	0.37	0.37
Total Power (kW)	27	33	37	29
Consumption (A)	55	62	73	56
Dust extraction connection (Ø mm)	(2x) 150	150 + 185	(2x) 150 + (2x) 101	(2x) 150
Dimensions (mm)	2300x2260x2230	3560x2320x2300	3840x2200x2200	3020x1980x2300
Weight (kg)	3250	4900	4700	3500

* with variable speed



MAX.
WIDTH



BENT
TUBE



WET
COOLING



MAX.
DIAMETER



No. ABRASIVE
BELT STATIONS



STRAIGHT
TUBE



No. POLISHING
STATIONS



**AUTOMATIC POLISHING SOAP;
SPRAY GUN WITH LIQUID
COMPOUND OR SOLID
POLISHING BAR SYSTEM**

**DIFFERENT MODELS AVAILABLE:
ROUND TUBES UP TO Ø254MM,
RECTANGULAR TUBES UP TO 220MM**



4

MIRROR POLISHING MACHINES

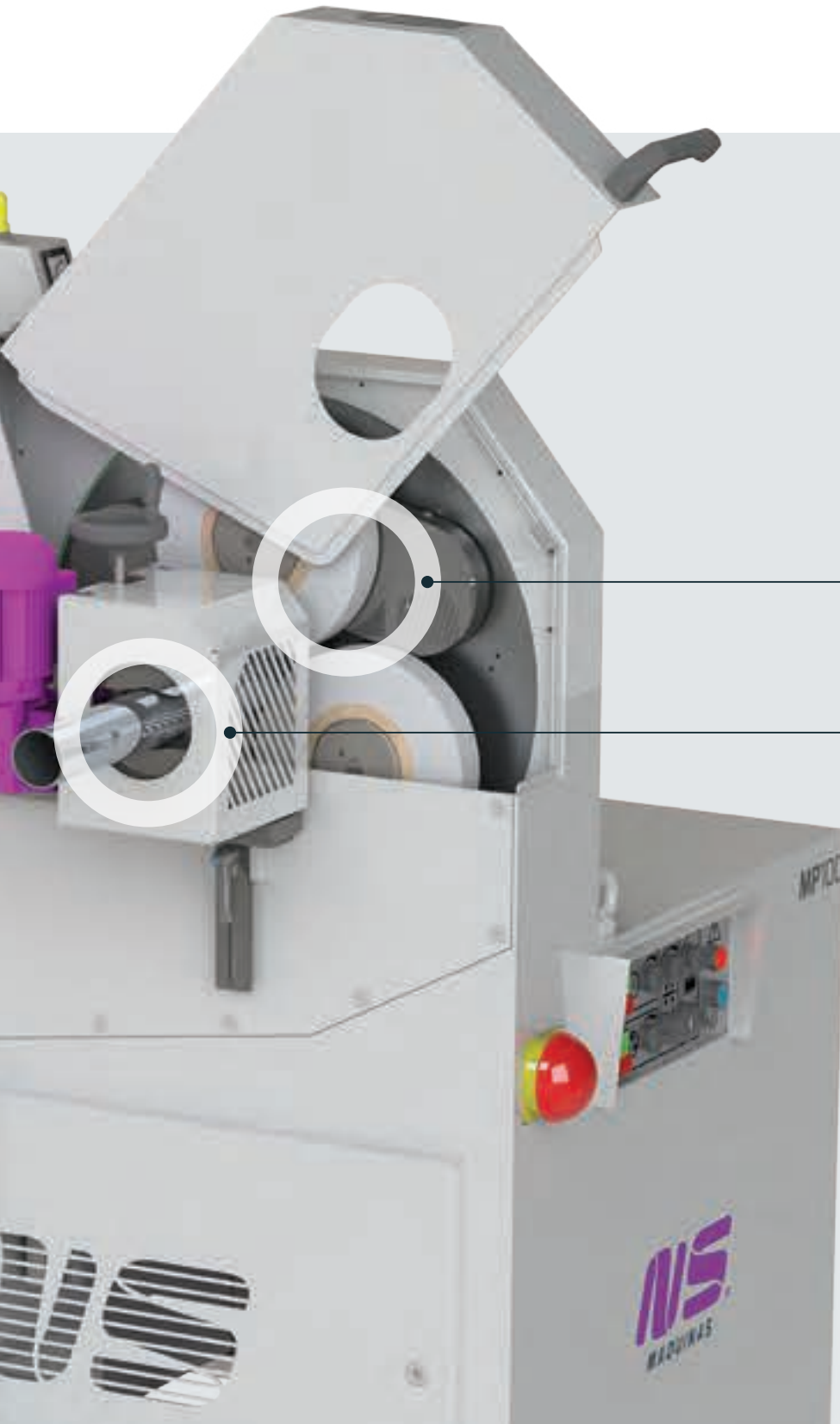

SINGLE OR MULTIPLE
POLISHING STATIONS

UNIQUE DESIGNS FOR HIGH
QUALITY MIRROR POLISHING.
SYSTEMS WITHOUT TUBE SUPPORT

MP100



ROUND TUBE POLISHING MACHINE



Mirror polishes straight and curved tubes



Before and after mirror polishing



Automatic solid soap system



PC70 2P



ROUND AND RECTANGULAR TUBE POLISHING MACHINE



Polishes round and rectangular straight tubes



Automatic polishing spray system integrated





RC200

ROUND TUBE POLISHING AND FINISHING MACHINE



RC200 enables wet and dry belt finishing and mirror polishing



Option for automatic polishing soap system



Easy changing of contact roller for polishing wheel



PP220 2K

RECTANGULAR TUBE AND FLAT BAR POLISHING MACHINE



Double brush with independent wear and pressure regulation



Suitable for rectangular tubes and flat bars

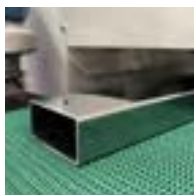

PL40



MANUAL POLISHING AND FINISHING MACHINE



PL40 and PL80 machines are available in different configurations:
ZP (1 abrasive belt plus one polishing wheel unit),
PP (double polishing wheel unit) and ZZ (double abrasive belt)



Simple and reliable polishing machines with one single motor



PL80



MANUAL POLISHING AND FINISHING MACHINE



Long distance from the polishing unit to the body of the machine: accessibility for awkward-shaped work pieces

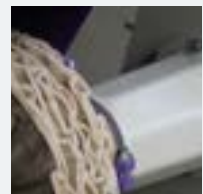

Double motor for independent operation with two workers

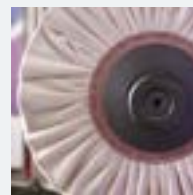

Technical Details

	MP100	PC70 2P	RC200	RC250	PP220 2P	PL40	PL80
Working capacity (Ømm)	40-114	Ø70 or 70x70	10-206	10-254	220x200	-	-
No. of Polishing Stations (P)	1	2	1	1	2	0-2	0-2
No. of Abrasive Belt Stations (Z)	-	-	1	1	-	0-2	0-2
Polishing wheel dimensions (mm)	(3x) (2x) Ø180-240	(2x) (3x) Ø350x35	(3x) Ø350x75	(3x) Ø350x75	(2x) 220xØ400	(3x) Ø500x35	(3x) Ø500x35
Abrasive belts dimensions (mm)	-	-	100x3000	100x3000	-	3500x50	3500x50
Polishing wheel speed (m/s)	up to 35	26.6-36	30	30	15-35m/min	30	30
Abrasive belts speed (m/s)	-	-	25	25	-	30	30
Feeding speed (m/min)	0-3	1-6	1-5	1-5	2-8	-	-
Polishing motor (kW)	5.5	(2x) 5.5	4	5.5-7.5	(2x) 7.5	4	4-7.5
Abrasive belts motor (kW)	-	-	4	5.5-7.5	-	-	4-7.5
Feeding motor (kW)	(2x) 0.12	(2x) 0.25	1.5	1.5	(2x) 0.25	-	-
Total Power (kW)	6	12	6-7	7-9	16	4	8-15
Consumption (A)	22	24	11-15	15-18	80	9	18-30
Dust extractor connection (Ømm)	120	(2x) 120	100	100	(2x) 150	(2x) 120	(2x) 120
Dimensions (mm)	1250x1100x1550	3760x1400x2125	1700x900x1950	1700x900x1950	2582x1315x2191	1250x650x2600 ⁽¹⁾	1800x700x2800 ⁽¹⁾
Weight (kg)	420	2050	530	550	2000	320 ⁽¹⁾	580 ⁽¹⁾

⁽¹⁾ Values for ZP model

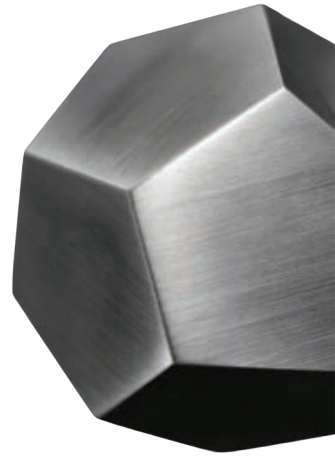

DRY AND WET DUST
EXTRACTORS AVAILABLE
WITH DIFFERENT CAPACITIES
(A, AS AND AW)

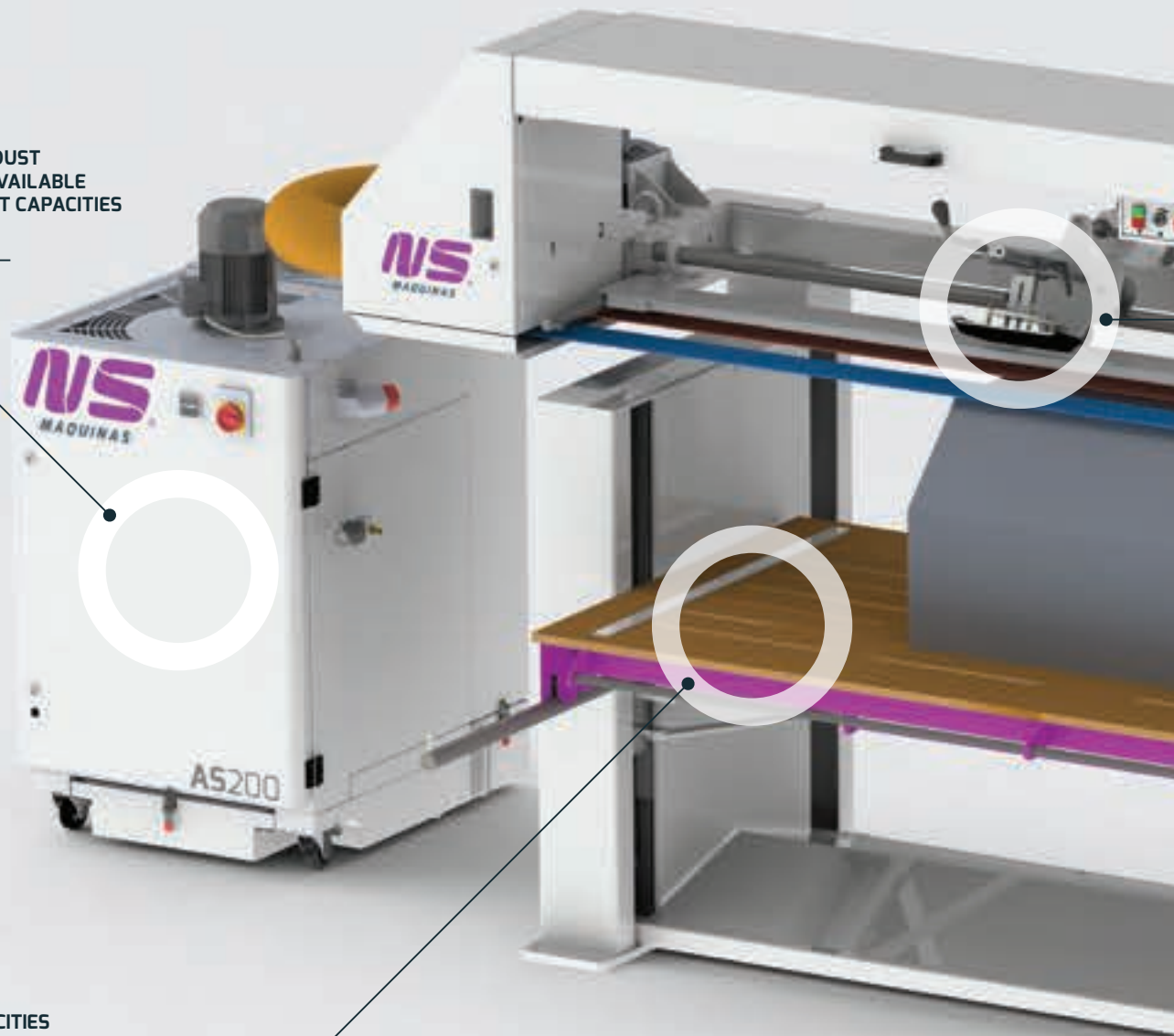

WORKING CAPACITIES
UP TO 4000MM
AVAILABLE

5

OTHER BELT FINISHING MACHINES AND EQUIPMENT

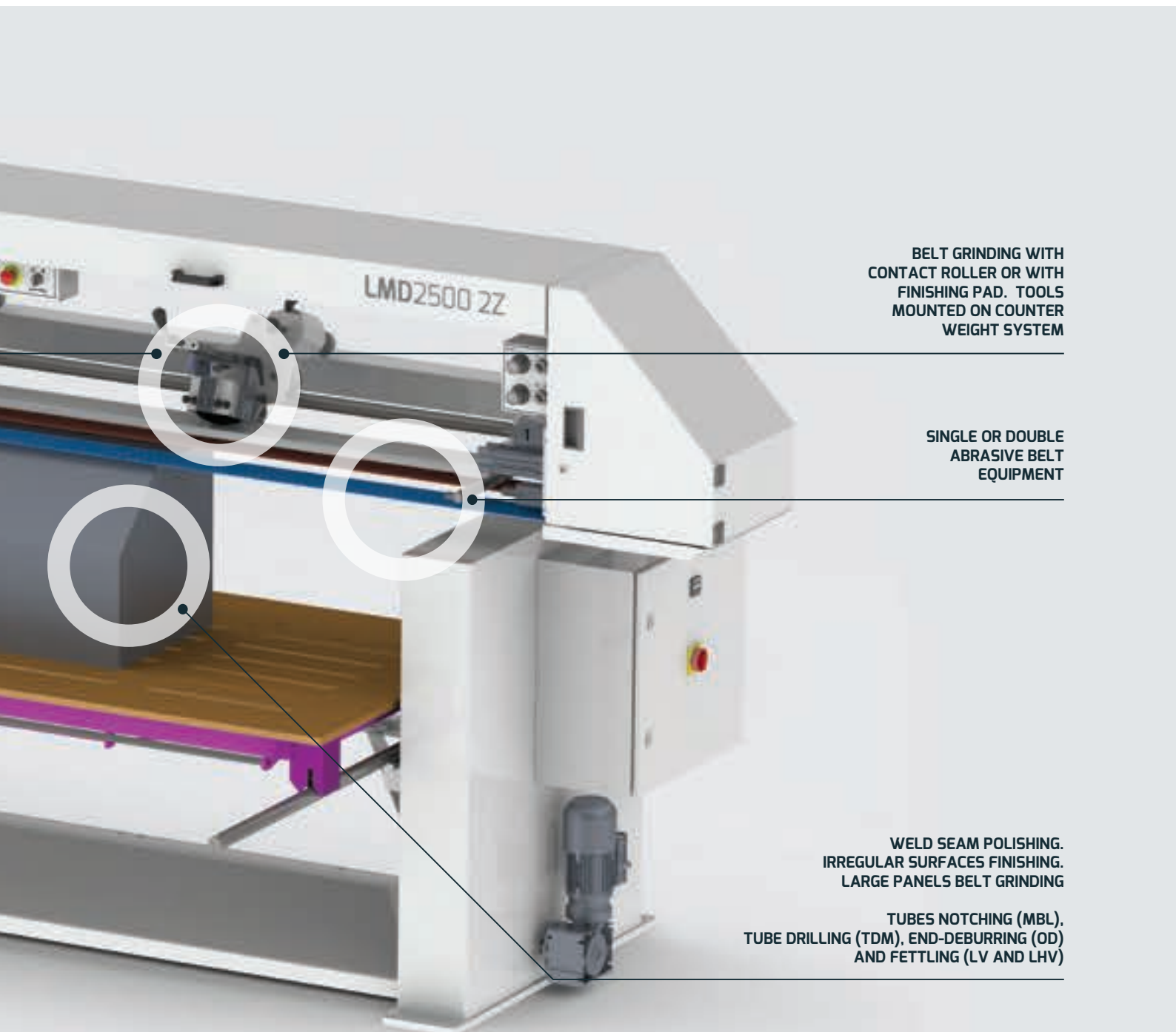

BELT GRINDING WITH CONTACT ROLLER OR WITH FINISHING PAD. TOOLS MOUNTED ON COUNTER WEIGHT SYSTEM

SINGLE OR DOUBLE ABRASIVE BELT EQUIPMENT

WELD SEAM POLISHING.
IRREGULAR SURFACES FINISHING.
LARGE PANELS BELT GRINDING

TUBES NOTCHING (MBL),
TUBE DRILLING (TDM), END-DEBURRING (OD)
AND FETTLING (LV AND LHV)

LMD2500

LONG BELT FINISHING MACHINE



Boxes and welded
structures belt finishing

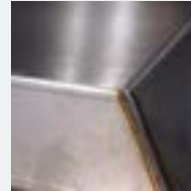

Flexible contact roller

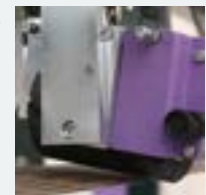

LMD4000

LONG BELT FINISHING MACHINE



Control panel easy
to reach positioned
at the center



Tools in counterweight
system - smooth
operation



CLF75

PANELS BELT GRINDING MACHINE



Weld seam and heavy sheets grinding



Manual adjustment of pressure for precise finishing



LMD2500 2Z

LONG BELT FINISHING MACHINE



Double station: belt grinding and finishing in one machine



Pneumatic abrasive belt tensioning



LR30 AT

METAL SHEET DEBURRING MACHINE



Two deburring wheels
in opposite directions
deburr upper and lower
edges in one single pass



Automatic feeding and
support table for large
metal sheets



Double working position:
horizontal and vertical



OD120

TUBE END DEBURRING MACHINE



Orbital brush with double
rotation deburring inside
and outside edge of
tubes without rotating
them



Variety of tubes
and profiles with the
same model



LB50

WORK BENCH BELT GRINDING MACHINE



Contact roller grinding for material removal and deburring



Free belt area for flexible finishing



MBL120

TUBE NOTCHING MACHINE



Perfect junction of tubes



Top abrasive belt section for tube end deburring



TDM2 AT

TUBE DRILLING MACHINE



Tubes drilling, flowdrilling and threading

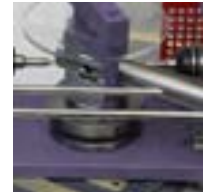

Automatic or semi-automatic manual models



LHV200

HORIZONTAL AND VERTICAL BELT GRINDING MACHINE



Horizontal and vertical abrasive belt working position



LV200

VERTICAL BELT GRINDING MACHINE



Fettling tubes at 45°



Adjustable table and guide angles





Filter bag dust extractors



Single or double bag filter available in different capacities (A100, A200, A300 and A400)



A200

DUST EXTRACTOR



High efficiency cartridges with automatic filters cleaning system



Ample capacity for all machine requirements (AS200, AS400 and AS800)



AS200

DUST EXTRACTOR



Wet Systems made in steel or in stainless steel (AW600, AW800 and AW1300)



AW800

WET DUST EXTRACTOR

Technical Details

	LMD2500	LMD3100	LMD4000	LR30 AT	MBL120	TDM2
Working capacity (Ømm)	2500x850x700	3100x850x600	4000x1000x700	0-15	○ 110 □ 110x110	○ 80 □ 80x80 — 80x15
Max. Drill (mm)	-	-	-	-	-	Ø 43; M10 (flow drill)
Abrasive belts dimensions (mm)	7800x120	9000x120	10800x120	30xØ250	2000x120	-
Abrasive belts speed (m/s)	20	20	20	6	30	-
Main motor (kW)	4	4	5.5	(2x) 0.22-0.15	3	(2x) 2.2
Total Power (kW)	5	5	6	1	3	6
Consumption (A)	9	10	12	2	7	10
Dust extractor connection (Ømm)	120	120	120	80	(2x) 80	-
Dimensions (mm)	4000x1600x2000	4600x1600x2000	5500x1900x2050	1520x820x1150	1450x950x1200	4100x1700x1450
Weight (kg)	920	930	1000	180	210	400

	LB50	CLF75	LHV200	LV200	OD120	OD160
Working capacity (Ømm)	-	-	-	-	10-120	10-160
Abrasive belts dimensions (mm)	1750x50	2000x75	3200x200	3000x200	(3x) Ø250x60	(4x) Ø250x60
Abrasive belts speed (m/s)	30	30	18	19	18+35	18+35
Total Power (kW)	0.75	4	3	3	3	4
Consumption (A)	2	9	6	6	8	10
Dust extractor connection (Ømm)	-	80	150	120	-	-
Dimensions (mm)	760x340x380	1520x700x1030	1900x700x1200	810x1100x1850	1140x670x1400	1140x670x1400
Weight (kg)	35	97	190	300	505	540

	A100	A200	AS200	AS400	AW600	AW1300
Motor (kW)	1.1	1.5	2.2	4	3	15
Filters (mm)	Ø450x1100	(2x) Ø480x1500	(2x) Ø325x400	(6x) Ø325x750	-	-
Capacity (m³/h)	1700	2200	2280	4000	3200	11800
Connection (Ømm)	150	150	150	150	170	350
Dimensions approx. (mm)	1000x500x2200	1700x500x2200	955x750x1450	1200x1100x2250	Ø600x2200	Ø1300x3300
Weight approx. (kg)	60	80	170	470	200	920

With a technical and sales network spread over the 5 continents NS is able to supply the complete and on time support from the machine purchase and set-up to the spare parts delivery and technical advice.

NS invites you to come and visit the company where you may join NS team and feel and experience the use of an NS machine.

NS is close to the customer

 @nsmaquinas

 @nsmaquinas

 @nsmaquinas

 @nsmaquinas



SCAN TO WATCH NS VIDEOS ▶

SOME OF OUR REFERENCES





***“Limits
don’t exist...”***

Jacek Szostak





NS - Máquinas Industriais, Lda.
Av. D. Miguel, 106
4435-678 Baguim do Monte
Gondomar
Portugal

Tel +351 229 741 618
Fax +351 229 741 619
info@nsmaquinas.com
www.nsmaquinas.com