











Technische Details
 Technical Details

BPM	pad (mm)	mm/in"	mm/in"	kg/lb	l/min/cfm	inch"	m/s	dB (A)	bar/psi
									
59010	2,600	93 x 178	10 (3/8")	190 (7.5)	1.0 (2.3)	70.8 (2.5)	1/4	6.99	82.1/93.1
									6.3 (90)

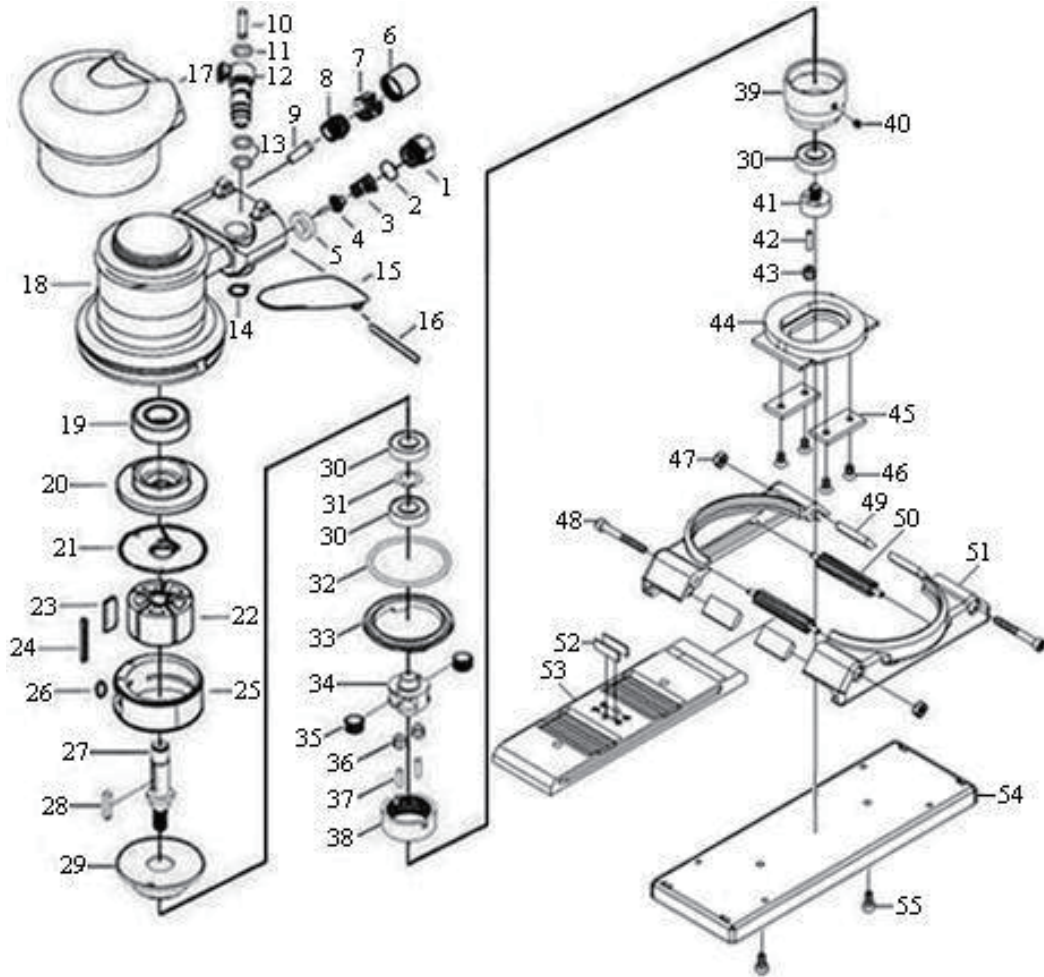

* Due to our continuous improvement, all specifications are subject to change without prior notice.

Index No.	Description	Quantity	Index No.	Description	Quantity	Index No.	Description	Quantity
1	Inlet Housing	1	20	Rear End Plate	1	39	Gear Housing	1
2	Washer	1	21	Steel Plate	1	40	Screw	1
3	Spring	1	22	Rotor	1	41	Shaft	1
4	Valve	1	23	Rotor Blade	5	42	Pin	1
5	Seal	1	24	Spring Pin	1	43	Needle Roller	1
6	Cover(Alum)	1	25	Cylinder	1	44	Counter Weight	1
7	Felt	1	26	O-Ring	1	45	Guide Plate	2
8	Muffler Body	1	27	Motor Shaft Balancer	1	46	Screw	4
9	Cone Muffler	1	28	Key	1	47	Nut	2
10	Valve Stem	1	29	Front End Plate	1	48	Screw	2
11	O-Ring	1	30	Ball Bearing	3	49	Felt	4
12	Valve Bushing	1	31	Packing	1	50	Transfer Pinion	2
13	O-Ring	2	32	O-Ring	1	51	Gear Box	2
14	Snap Ring	1	33	Safeguard Bushing	1	52	Steel Plate	2
15	Lever	1	34	Gear Cage	1	53	Silde Board	1
16	Spring Pin	1	35	Gear	2	54	Pad	1
17	Rubber Cover	1	36	Needle Roller	2	55	Screw	2
18	Housing	1	37	Pin	2			
19	Ball Bearing	1	38	Internal Gear	1			