

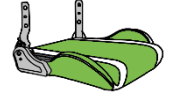

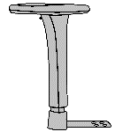

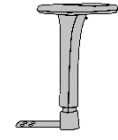

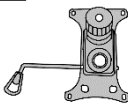



**GAMING CHAIR MODEL
RTA-TSF71**

ATTENTION:

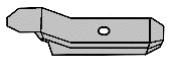
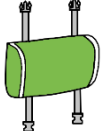
- ⚠ Follow the instructions step by step.
- ⚠ To avoid misalignments, leave the screws loose and do not tighten them until all are in their respective places.
- ⚠ Do not overtighten or force the screws as they could break, strip, or damage the threads of the holes.
- ⚠ Using the wrong size of screws on a part could result in damage to the screw or the part.

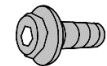
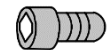
A Backrest 	B Seat 	C-L Left Armrest 	C-R Right Armrest 	D Mechanism 	E Gas Lift 	F Covers for gas lift, set of 3 pcs 	G 5-leg star base 	H Casters, 5 pcs. 	I-L Left cover for seat bracket 
I-R Right cover for seat bracket 	J Lumbar pillow 	K Allen wrench 	L M8x20mm, 16 pcs 	M M5x8mm, 2 pcs (for bracket covers) 	N Hole covers, 2 pcs 				

STEP 1 Insert the casters (H) into the legs of the base (G) using pressure, then place the gas lift (E) in the middle of the base and cover it with (F).

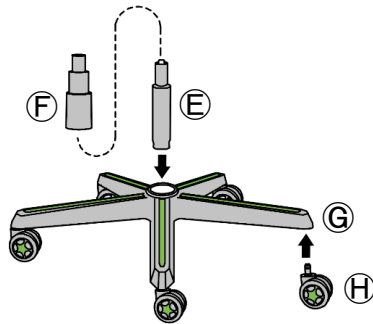

STEP 2 Flip over the seat (B) with its back end towards you, and using screws (L), assemble the mechanism (D) with its handle facing to the LEFT as shown.

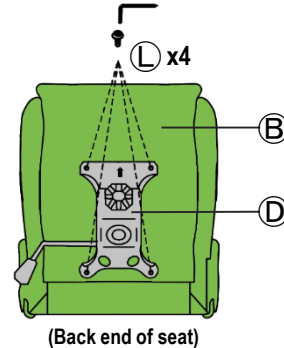

STEP 3 Assemble the armrests (C-L) and (C-R) in their respective side of the seat (B) using screws (L).

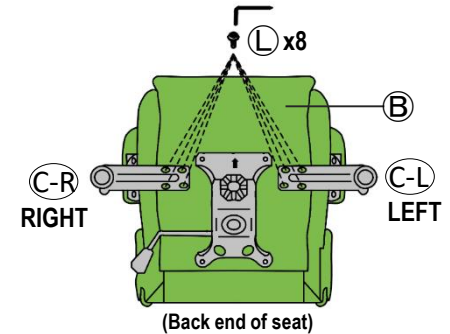

STEP 4 Place the top parts over the base parts making sure the tip of the gas lift enters into the hole of the mechanism, then assemble the backrest (A) to the metal brackets on both sides of the seat (B) using screws (L) as shown.

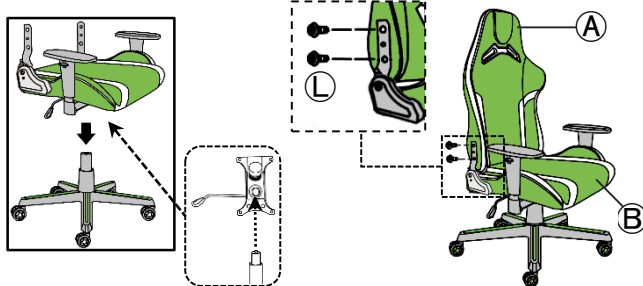

STEP 5 Attach the covers (I-L) and (I-R) to the brackets on their respective sides of the seat (B) using screws (M) and cover the holes with (N) as shown.

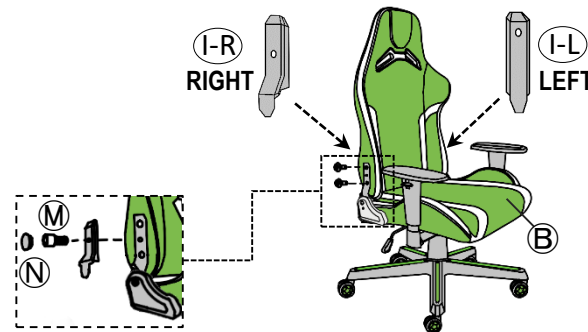

STEP 6 Attach the lumbar pillow (J) by fastening the buckles behind the backrest (A) as shown.

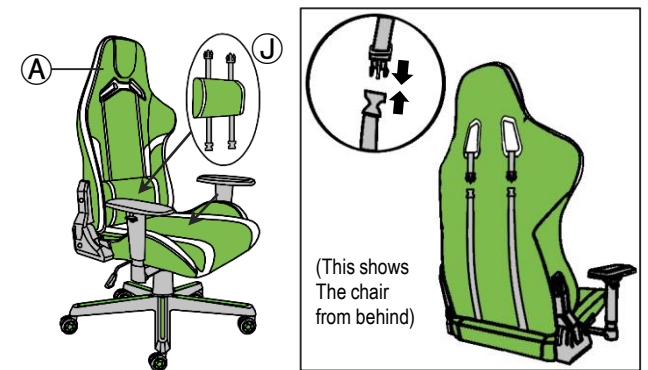

CHAIR'S FUNCTIONS:

- ① To raise or lower the chair's height, pull UP the lever that is under the seat. The chair goes down while sitting on it, or up if you lift your body.
 - ② To make the chair tilt, pull the same lever OUT horizontally to unlock this function, and IN to lock again. Please note that unlike regular office chairs, gaming chairs have their base components off-center, and the tilting won't be much and might actually feel hard to tilt.
 - ③ To adjust the tension for the tilting function, turn the mechanism's knob in either direction to apply more or less tension. With less tension, the tilting will feel easier.
 - ④ To make the backrest recline, pull UP the lever that is located on the rear right side of the seat and release it when the desired position is reached.
- WARNING:** For your safety, the chair's tilt function ② should be in the **LOCKED (IN)** position prior to use the backrest reclining function.
- ⑤ To adjust the armrest height, pull UP the button that is under the armrest and release it once the desired height is reached.

Before seating and using the chair for the first time, make sure that all screws are properly tightened.

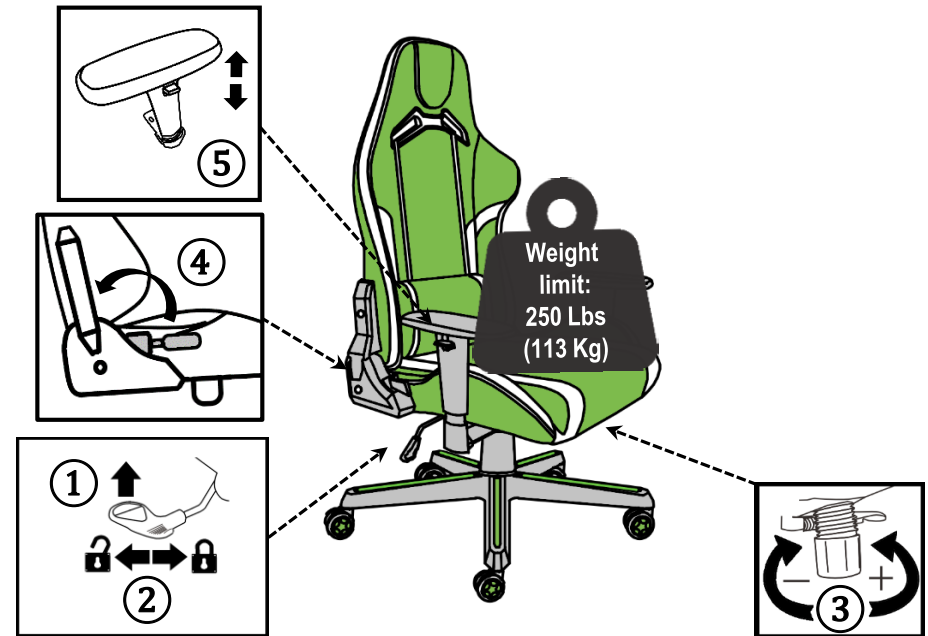

WARNINGS:

- Do not stand up on the chair or use it as ladder.
- Use the chair to seat only one person at a time.
- Do not use the chair if parts are damaged or if screws are loose or missing.
- Do not sit near the edge of the seat and always sit properly on the chair to avoid going beyond your balance point and fall off the chair.
- The chair is intended for teenagers and adults. If small children are using the chair, please keep close observation on them.
- Do not allow small children to play with the chair.
- Not paying attention to these warnings could result in severe injuries.

CARE, MAINTENANCE AND WARRANTY:

- To clean the chair it is recommended to use a soft cloth lightly damped in a solution of smooth soap and water, then dry with a clean towel.
- Do not use solvents or abrasive materials to clean any part of the chair.
- Before applying a cleaning agent, test on a small hidden area of the chair, like underneath the seat.
- Do not expose the product to direct sunlight or to extreme environmental conditions.
- Every 4 months, inspect the chair completely and make sure that all screws are tighten.
- Every 4 months, inspect the chair completely and make sure that all screws are tighten.
- Shall any part of the unit become defective during the warranty period, replacement parts might be available to you at no charge. Please refer to the WARRANTY card included with the product.
- The warranty does not extend to regular wear and tear, nor the manufacturer assumes liability for damages or consequences due to accidents, incorrect assembly, negligence, improper use, modifications, or not heeding the warnings.
- The warranty is limited to the continental United States. If you reside in Hawaii, Puerto Rico, U.S. Dependencies or other countries, please contact the supplier from where the unit was purchased.