

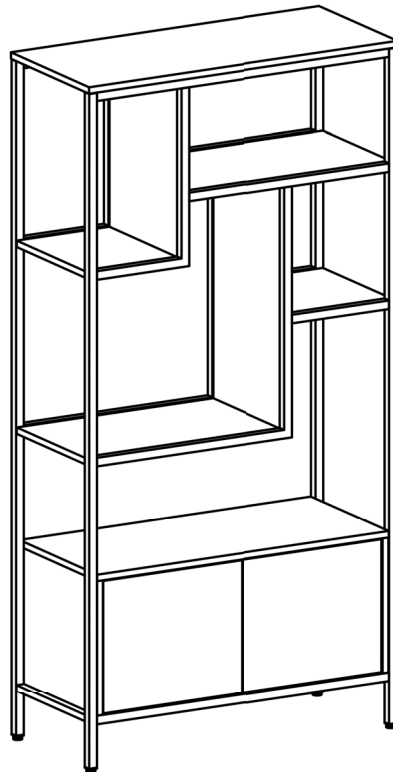

# MODEL RTA-482BC

## ASSEMBLY INSTRUCTIONS

Thank you for purchasing our product.





- Please read carefully the assembly instructions before the installation.











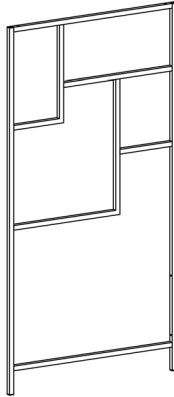
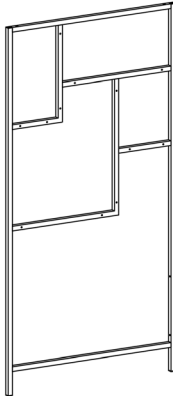

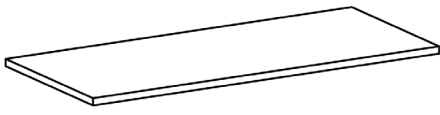
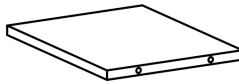
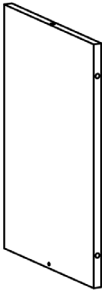

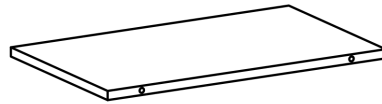
- Do not discard this manual or any of the packaging material until the unit has been completely assembled.

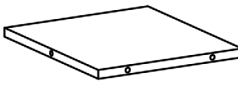
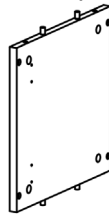
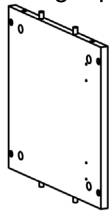

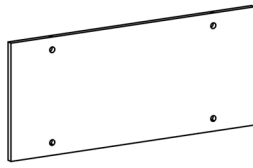

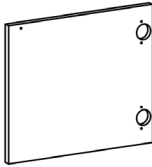
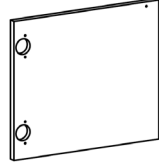
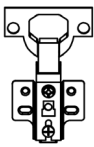
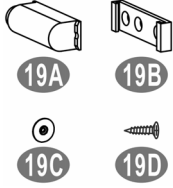

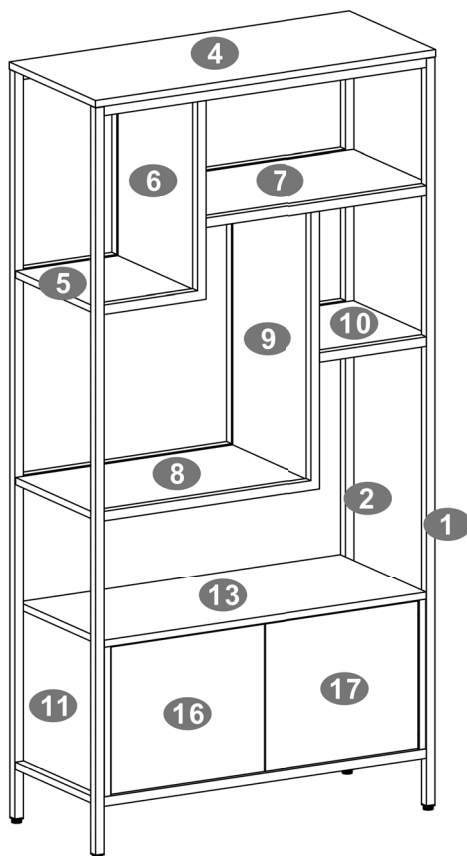

- Might require two people.

**MAIN PARTS LIST**

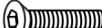
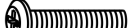
<b>1</b> x1	Front structure	<b>2</b> x1	Back structure	<b>3</b> x4	Glide Studs	<b>4</b> x1	Top panel		
									
				<b>5</b> x1	Upper left shelf	<b>6</b> x1	Upper left divider		
									
<b>7</b> x1	Upper right shelf	<b>8</b> x1		Middle left shelf		<b>9</b> x1		Middle divider	
									
<b>10</b> x1	Middle right shelf	<b>11</b> x1	Lower left panel	<b>12</b> x1	Lower right panel				
									
<b>13</b> x1	Lower shelf	<b>14</b> x1	Lower back panel	<b>15</b> x1				Lower panel	
									
<b>16</b> x1	Left door	<b>17</b> x1	Right door	<b>18</b> x4	Hinges	<b>19</b> x2 set	Door Spring kit	<b>20</b> x2 Strips	Covers
									

**MAIN PARTS LAYOUT (FOR REFERENCE):**

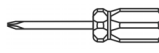
**LIST OF HARDWARE, SCREWS AND FITTINGS**

PART	QTY	ITEM	
A	18	M6x45 Bolt	
B	24	M6x40 Bolt	
C	8	M6x25	
D	4	M6x30	
E	4	ST3x15	
F	24	ST4x16	
G	2 Sets	Anchor Kit	
	1	Allen Key	
	1	Screwdriver	

☛ This unit uses cam bolts and locks. The following explains how to use them. This is not an assembly step; it is a guide for when you are actually doing the assembly using this kind of hardware.

Cam Lock



Cam Bolt

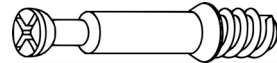

1. Screw the bolt into the corresponding hole on panel "A".

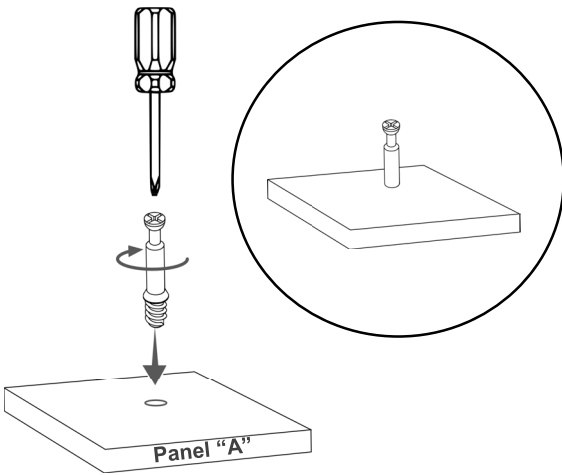

2. Join panel "B" to panel "A". There might be a very small gap between the panels which is normal.

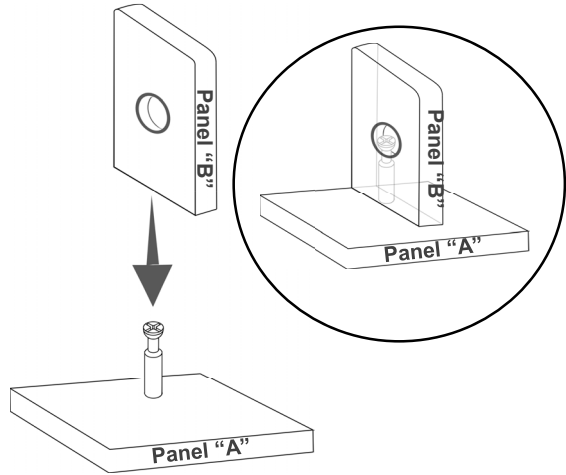

3. Insert the cam lock on panel "B", making sure it goes aligned to receive the bolt's head.

**Alignment:** The cross points towards the panel with the bolt.

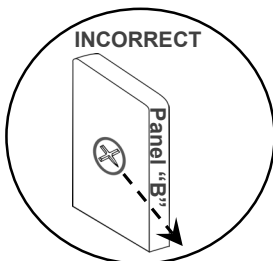
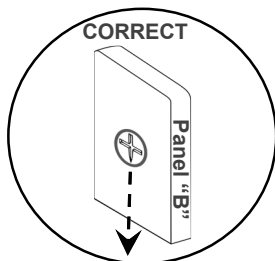
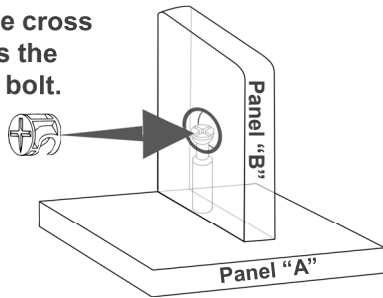

4. Turn the cam lock clockwise. This will lock the parts together and will close any gaps.

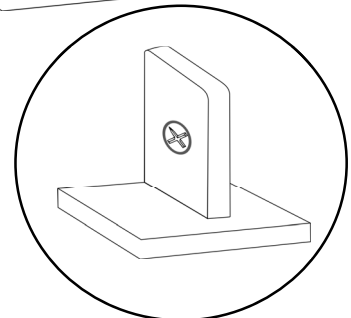
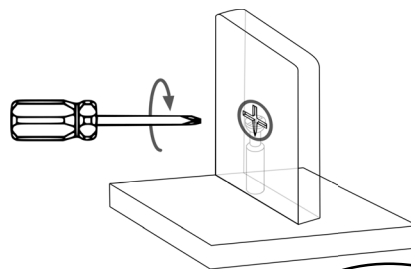

**BEFORE YOU START THE ASSEMBLY, PLEASE READ THE FOLLOWING TIPS AND WARNINGS.**

**1** Do a quick inventory to make sure the package contains all the parts and hardware listed in the assembly instructions.



**7** To avoid misalignments, always leave the screws loose and tighten them until all pieces are positioned correctly.

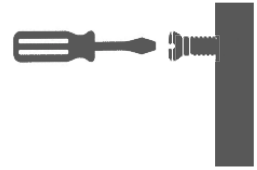

**2** Missing, damaged and defective parts can be replaced at no cost to you. Please refer to the last pages on this manual.



**8** Do not overtighten or force the screws as they might break, strip, damage the threads of the holes or get stuck inside the part.

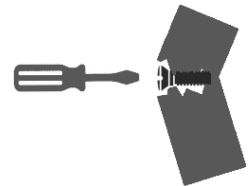

**3** The replacement parts service is limited to the 48 contiguous United States. If you reside in Alaska, Hawaii, Puerto Rico, U.S. territories or other countries, please contact the supplier from where the unit was purchased.



**9** Sometimes the laminate might cover partially or entirely the hole on a panel. If there is no visible hole for the screw, pass and press the tip of your finger over the area where the hole should be located to feel the indentation, and once found, carefully pierce the laminate to reveal the hole underneath.



**4** If during assembly you find an issue or need clarification, please contact our Customer Service for assistance. Please refer to the last pages on this manual.



**5** On each step read the instructions and analyze the illustrations thoroughly before proceeding to do the assembly.



**10** If the hole seems too small for the screw, first make sure you are using the correct size of screw and that it's been installed in the correct hole. If the hole still appears to be too small, carefully pierce the laminate to reveal the hole's actual size.



**6** Make sure you understand which hardware will be used on each step. Using the wrong size of screw, bolt or pin might strip the threads or cause damage to the part in which it is being used.

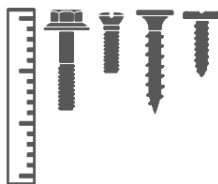

**ASSEMBLY STEPS**

**STEP 1**

**Hardware:**

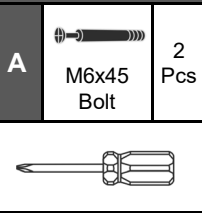

Assemble the shelves **5** and **7** to the Upper left divider **6** with bolts **A** as shown and as explained in page 4.

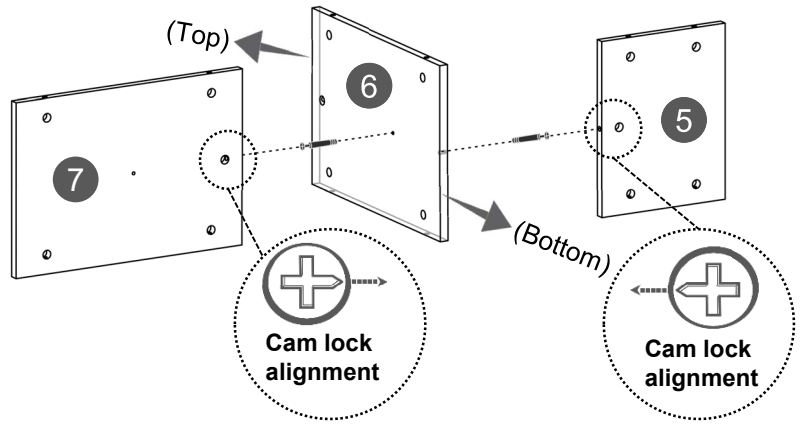
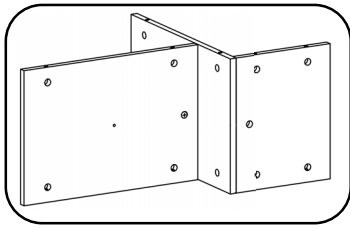

**STEP 2**

**Hardware:**

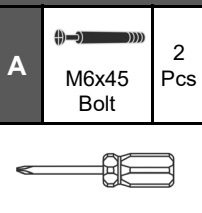

Assemble the shelves **8** and **10** to the Middle divider **9** with bolts **A** as shown and as explained in page 4.

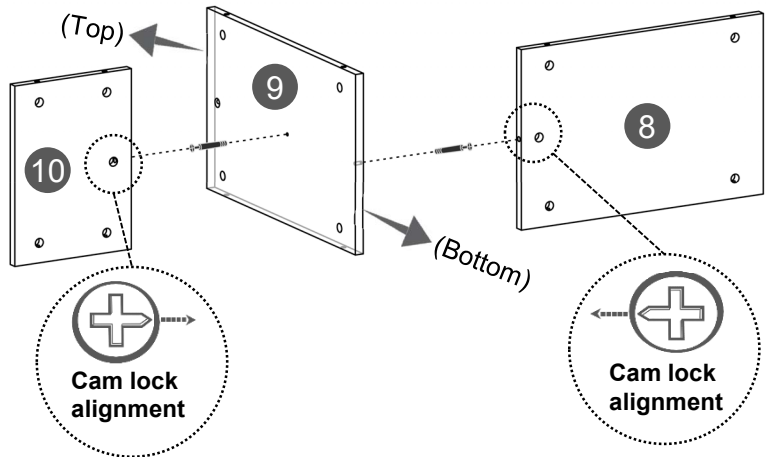
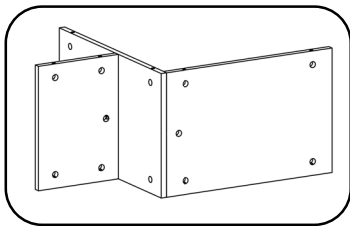

**STEP 3**

**Hardware:**

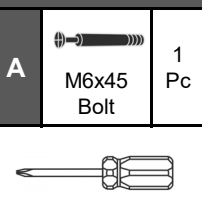

Assemble the shelf **7** from step 1 to the Middle divider **9** from step 2 with a bolt **A** as shown and as explained in page 4.

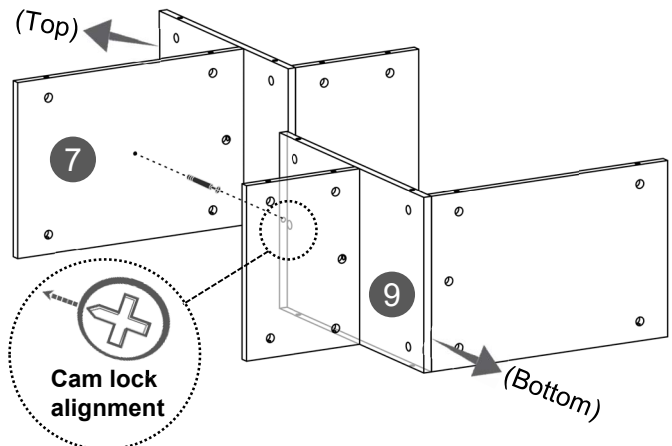
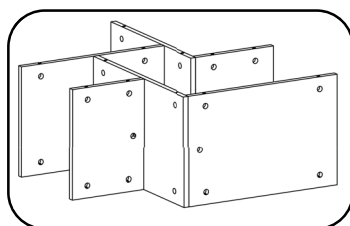

STEP 4

Hardware:

3



4 Pcs

Install the glide studs 3 into the bottom of the structures 1 and 2.

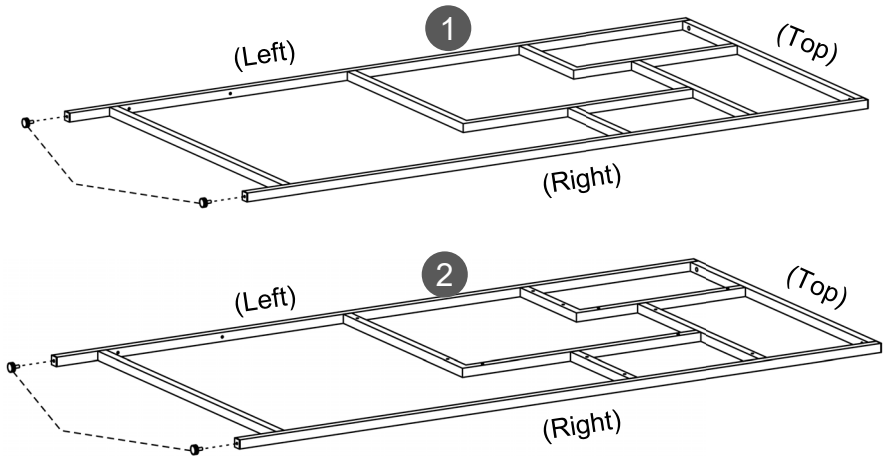

STEP 5

Hardware:

B



12 Pcs

M6x40 Bolt

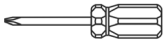

With the help of another person, assemble the Back structure 2 to all the panels assembled in step 7 with bolts B as shown and as explained in page 4.

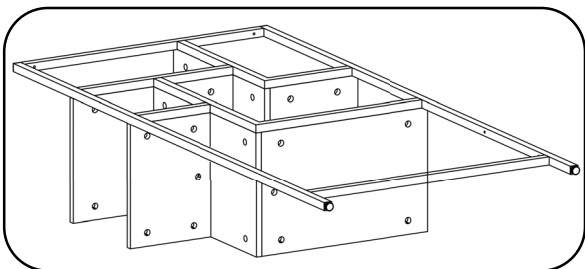
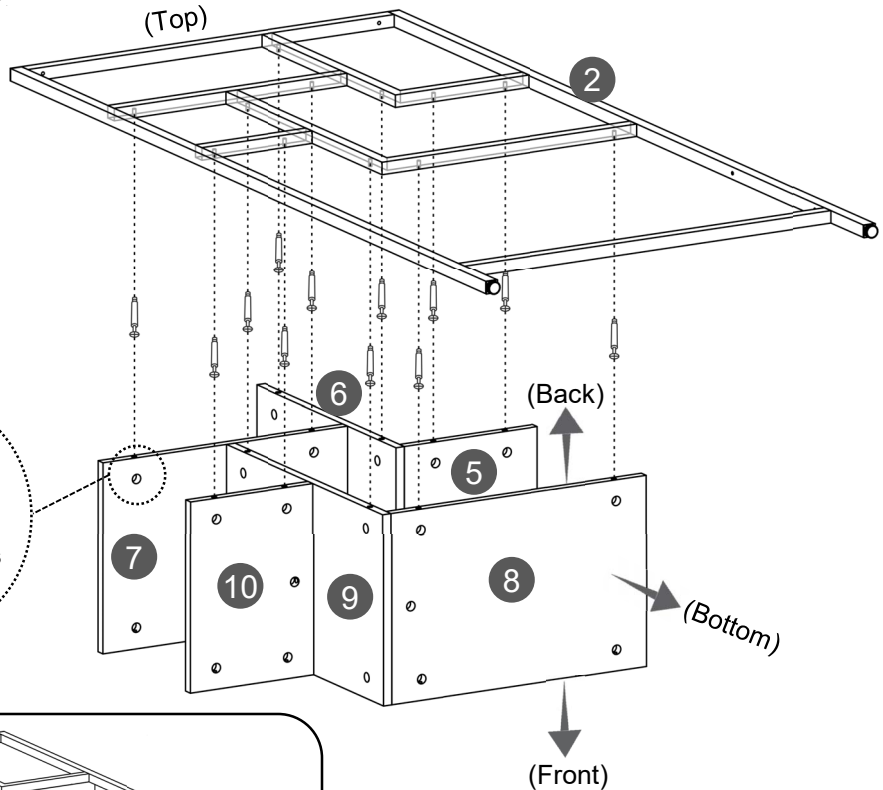



**ASSEMBLY STEPS**

**STEP 6**

**Hardware:**

**A**



M6x45 Bolt

2 Pcs

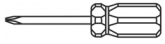

Assemble the Lower back panel **14** to the Lower panel **15** with bolts **A** as shown and as explained in page 4.

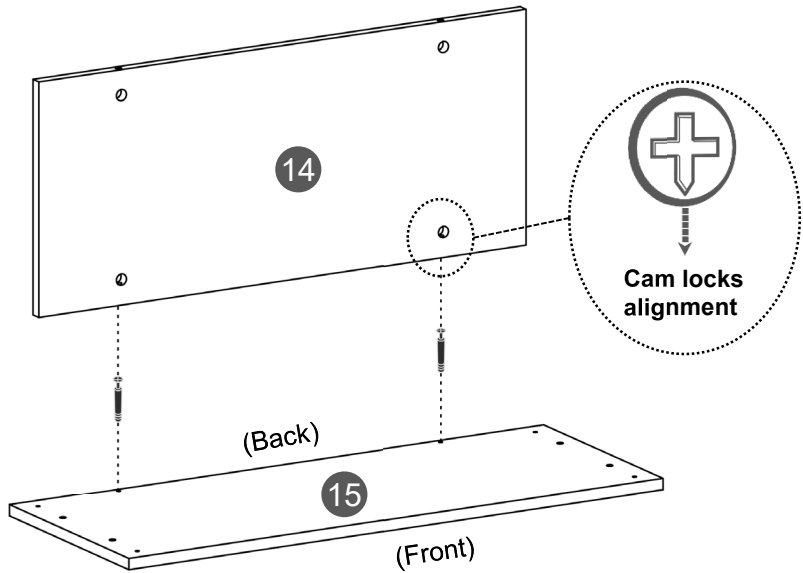

**STEP 7**

**Hardware:**

**A**



M6x45 Bolt

4 Pcs

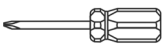

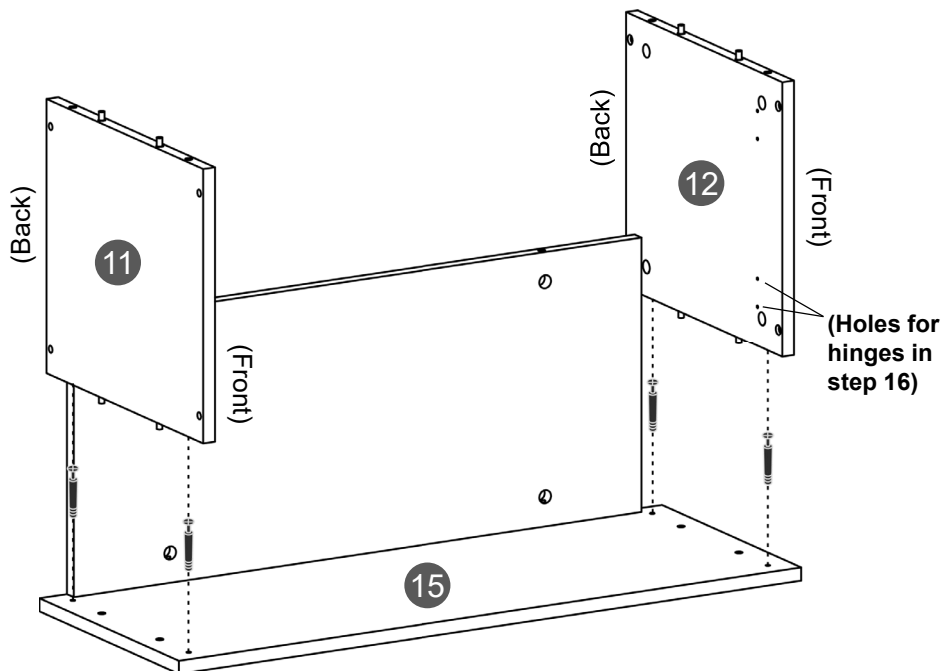

Assemble the Lower side panels **11** and **12** to the Lower panel **15** with bolts **A** as shown and as explained in page 4.



STEP 8

Hardware:

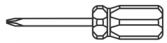
19 A		2 Pcs
19 B		2 Pcs
F		4 Pcs
		

- Attach the piece **19B** from the Door spring kit **19** to the lower shelf **13** with screws **F**, making sure the little **stopper** faces towards the **front**.

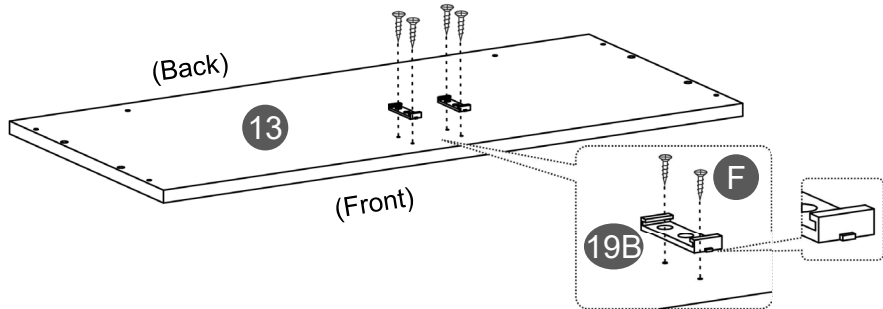

- Slide the spring piece **19A** from the Door spring kit **19** through the piece **19B** until it locks inside, making sure the **spring** button faces towards the **front**.

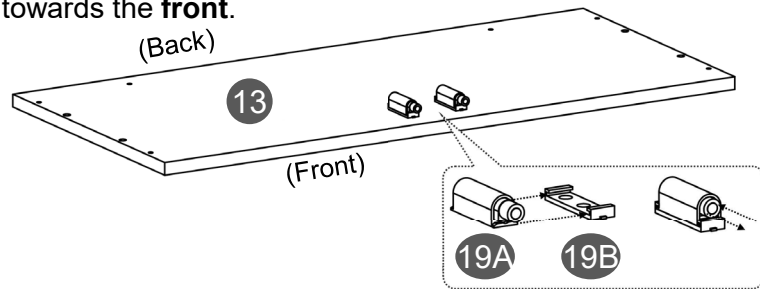

STEP 9

Hardware:

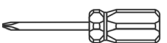
A		6 Pcs
		

Assemble the Lower shelf **13** to the panels **11**, **12** and **14** with bolts **A** as shown and as explained in page 4.

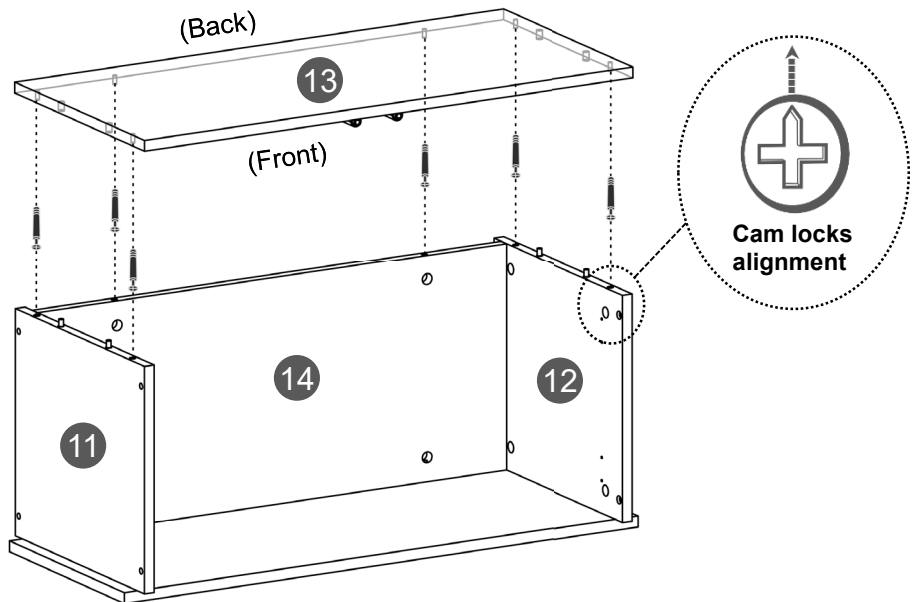

**STEP 10**



With the help of another person, turn over the frame built in step 5 and place the box built in step 9 over the lower section of the structure 2. The side panels 11 and 12 will engage inside the frame, while the bottom panel 15 will stay on top of it as shown.

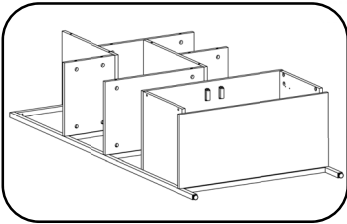
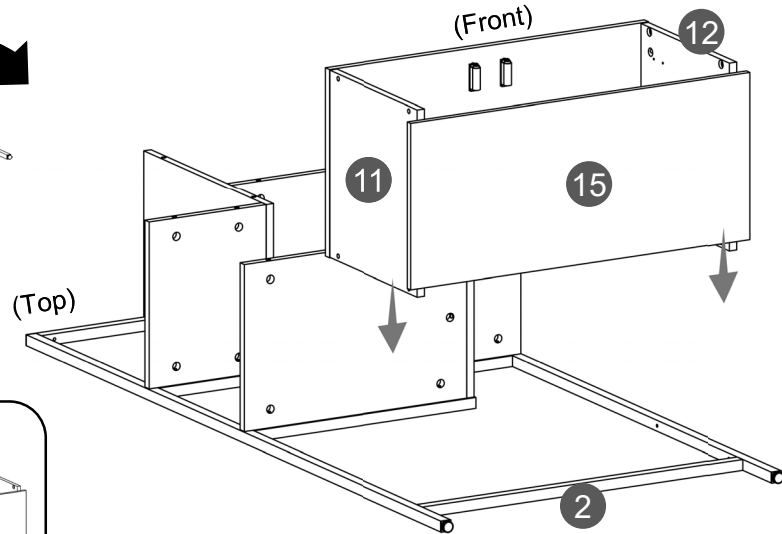
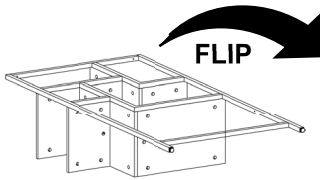

**STEP 11**

**Hardware:**

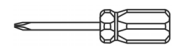
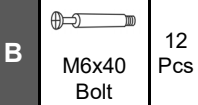

With the help of another person, assemble the front structure 1 to all the panels on the upper section of the frame with bolts B as shown and as explained in page 4.

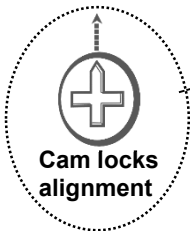
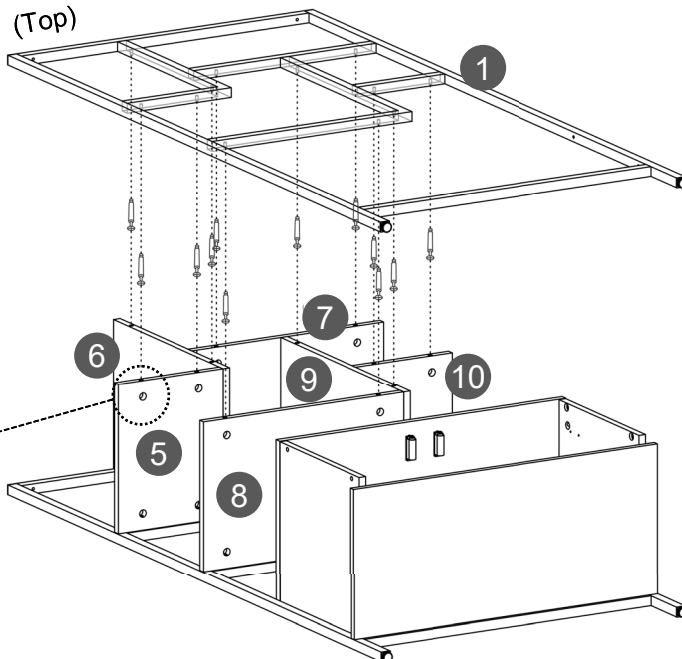

**STEP 10**



With the help of another person, turn over the frame built in step 5 and place the box built in step 9 over the lower section of the structure 2. The side panels 11 and 12 will engage inside the frame, while the bottom panel 15 will stay on top of it as shown.

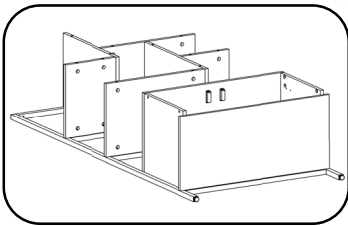
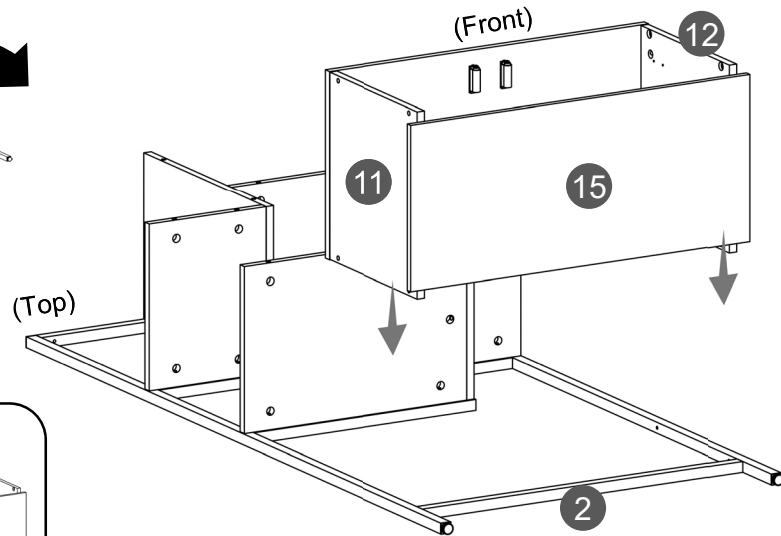
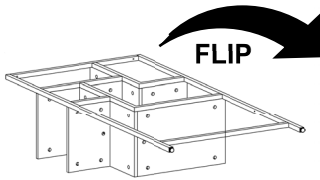

**STEP 11**

**Hardware:**

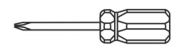
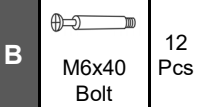

With the help of another person, assemble the front structure 1 to all the panels on the upper section of the frame with bolts B as shown and as explained in page 4.

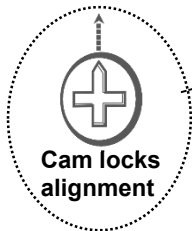
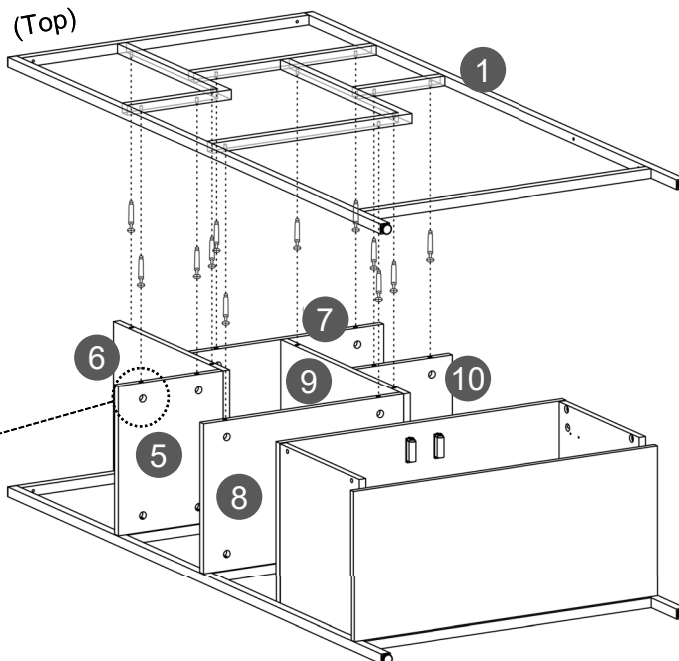

## STEP 12

## Hardware:

C

4  
Pcs

Secure the side panels **11** and **12** to the structure **1** with screws **C** from the inside.

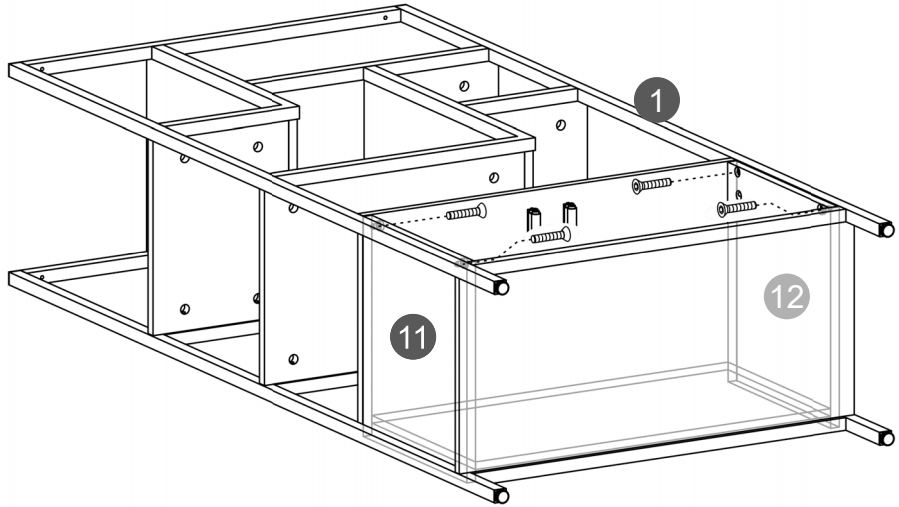

## STEP 13

## Hardware:

C

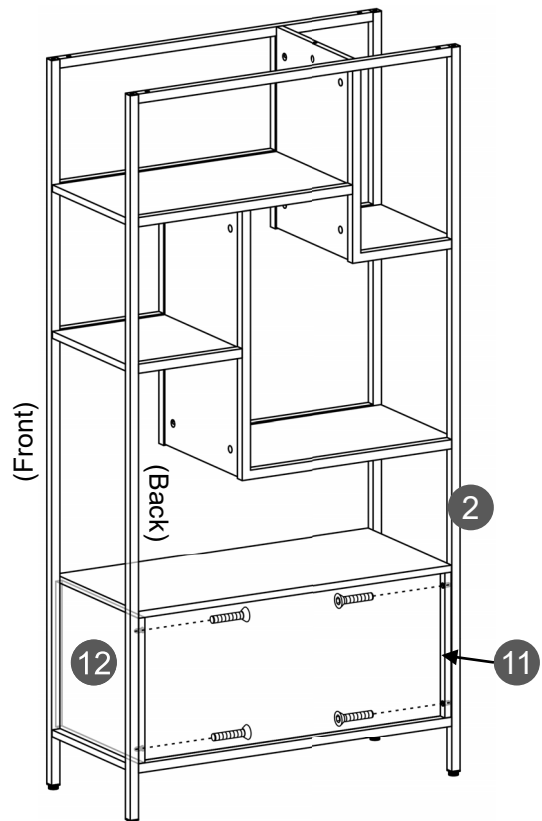
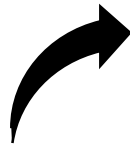
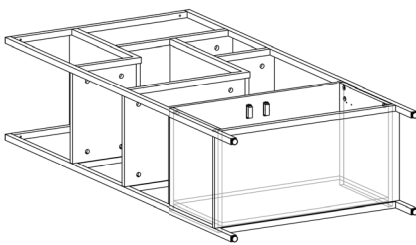

4  
Pcs

- With the help of another person bring the frame upright.
- Secure the side panels **11** and **12** to the back structure **2** with screws **C** from the inside.



**STEP 14**

**Hardware:**

<b>A</b>		1 Pcs
<b>D</b>		4 Pcs

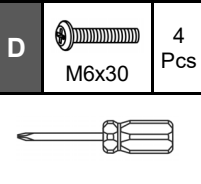

- Attach the remaining bolt **A** to the top panel **4** on the center hole.
- Assemble panel **4** to the Upper left divider **6** as shown and as explained in page 4.
- Secure panel **4** to structures **1** and **2** with screws **D** from underneath.

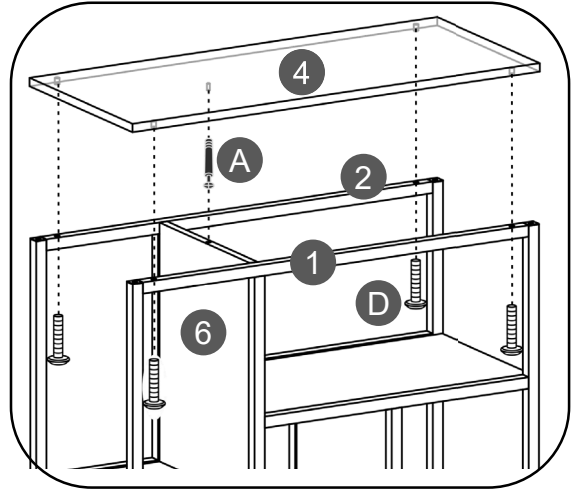
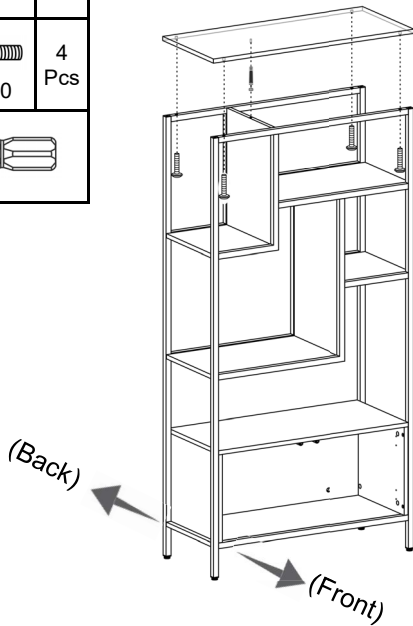



**STEP 15**

**Hardware:**

<b>F</b>		8 Pcs
----------	---	-------

<b>18</b>		2 Pcs
-----------	---	-------

<b>19 C</b>		
-------------	---	--

<b>19 D</b>		
-------------	---	--

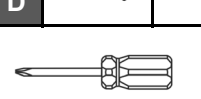

- Attach the metal disk **19C** from the Spring kit **19** to the doors **16** and **17** with the screws **19D**.
- Attach the Hinges **18** to the doors with screws **F**.

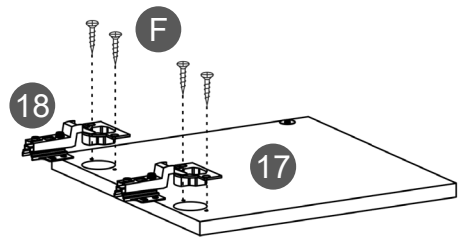
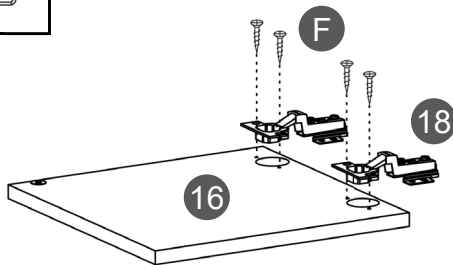
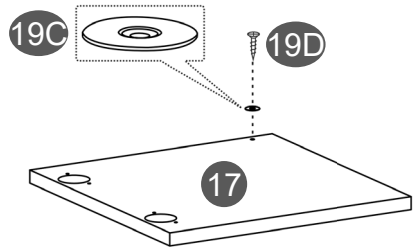
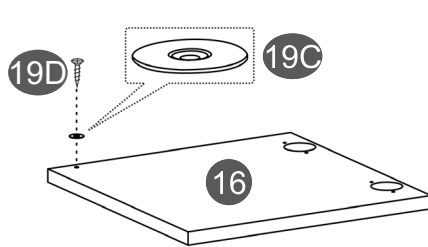

## STEP 16

## Hardware:

F

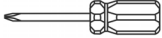
16  
Pcs

- With the help of another person, install the Door **16** to the Lower left panel **11** by attaching the Hinges **18** with screws **F** only on the oval holes.
- Install the Door **17** to the Lower right panel **12** by attaching the Hinges **18** with screws **F** only on the oval holes.

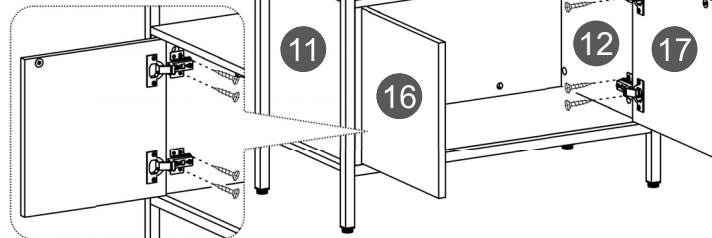
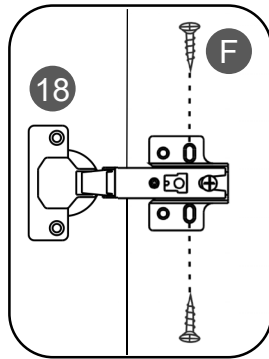

- If the doors are not closing properly or need alignment, proceed to do the following adjustments:

- Loosen these screws to adjust the height of the door.
- Loosen this screw to adjust the depth of the door.
- Turn this screw either way to adjust the door side-to-side.

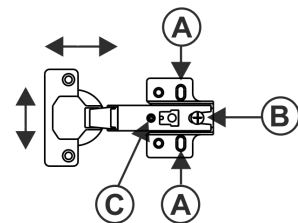

- After the adjustments are done, you can secure the hinges to the side panels with the rest of screws **F** on the round holes.

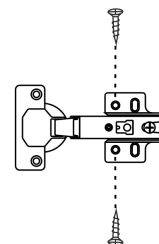

**STEP 17**

**Hardware:**

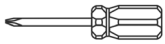
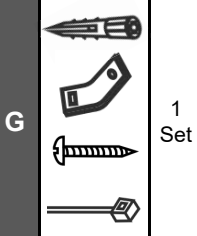

- Once you have selected the place against the wall where the unit will go, with the help of another person bring the unit closer to the wall, and calculate the 2 points on the wall where the anchor device **G** will be installed, which should be **no more than 1 inch away** from the top corners of the unit.
- Mark the points on the wall and with the appropriate tools make a hole to install the **anchors** from the kit **G**.
- Attach the **brackets** from the kit **G** to the anchors with the screws that come in the same kit.
- Use the **tie downs** from the kit **G** to secure the frame to the brackets.

**Securing the unit to the wall prevents accidents from tip-overs.**

- Cover all the cam locks on panels **6** and **9** with stickers **20**.

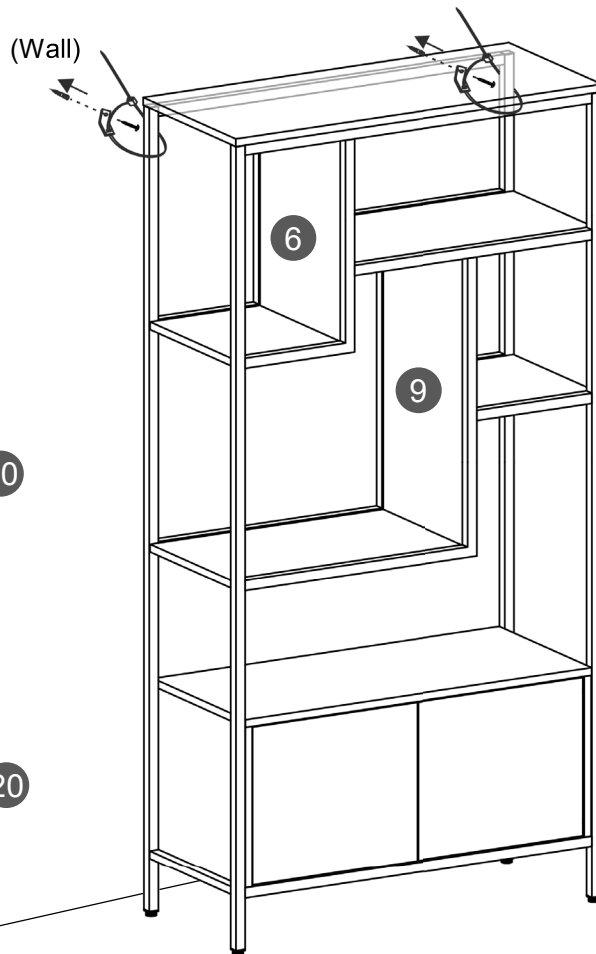
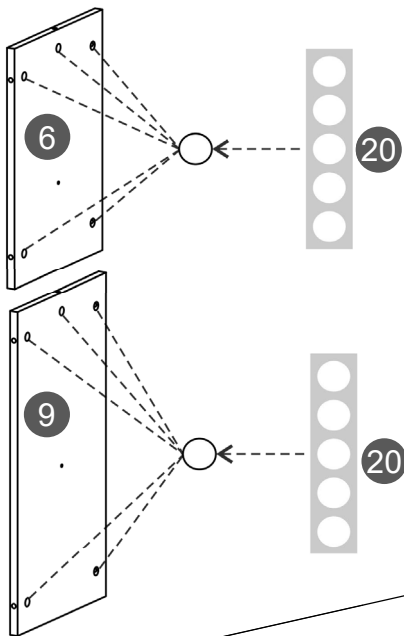
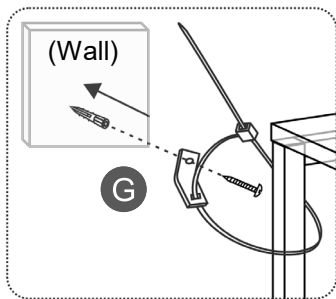



# ALL DONE!

Give yourself a nice pat on the back. You did a great job!

**IT IS EXTREMELY IMPORTANT  
THAT YOU READ ALL THE  
WARNINGS ON THE NEXT PAGE!**

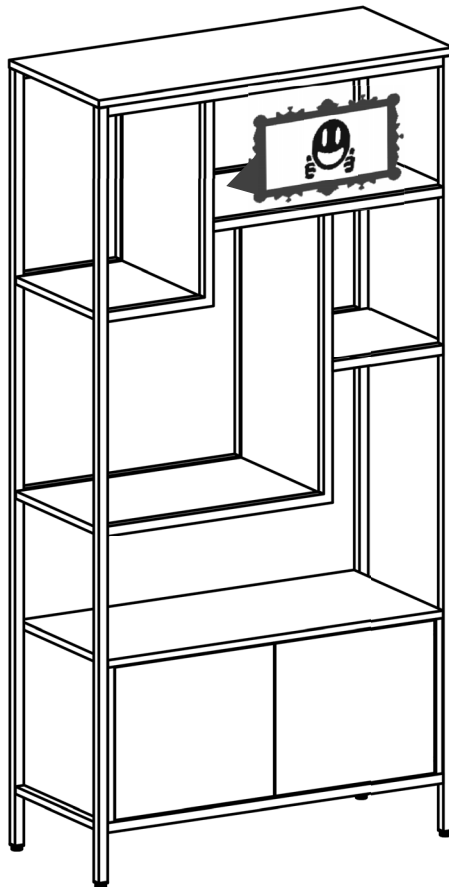

## TIP-OVER WARNING!

**Please keep your children and yourself safe. Tip-over accidents can result in serious injuries or be fatal to small children.**

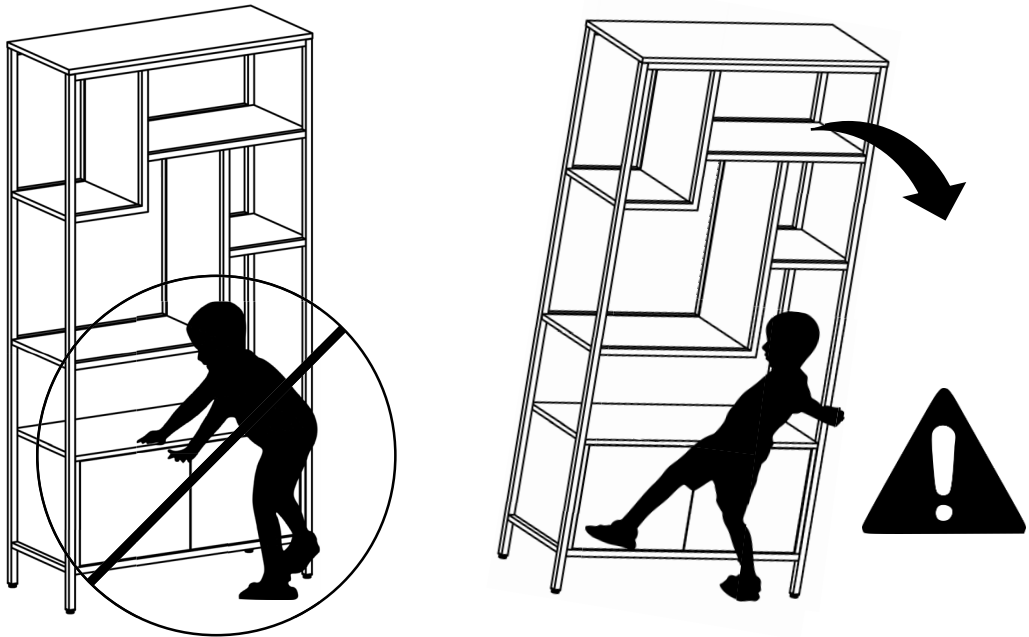

### **PREVENT TIP-OVER ACCIDENTS BY FOLLOWING THESE RECOMMENDATIONS:**

- 1. Secure the unit by anchoring it to the wall. The anchoring device has been provided with the unit, and must be installed by following the instructions shown in PAGE 14 of this manual.**
- 2. Once the unit has been anchored, load the heavier objects onto the lower shelves, and the lighter objects to the upper shelves.**
- 3. Never reach the objects on the upper shelves by climbing on the lower shelves.**
- 4. Do not let children climb on the shelves to reach objects located on the upper shelves, an adult should always grab the objects for them.**
- 5. Do not let children play on any empty shelf or inside the lower cabinet.**

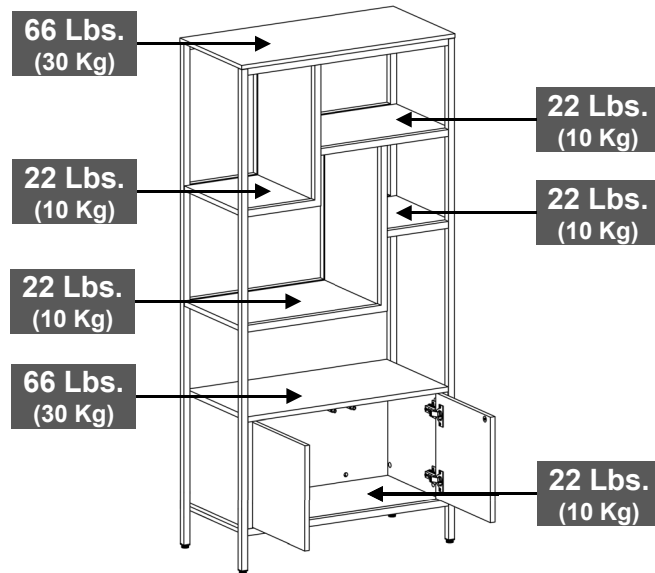
**CARE, MAINTENANCE AND SAFETY WARNINGS:****WEIGHT LIMITS**

- For the safety of small children and your own, secure the unit to the wall with the anchor device provided.
- Do not exceed the indicated weight limits.
- Always load the heavy objects on the lower shelves.
- Do not allow small children to climb or play on the shelves or inside the lower cabinet.
- Do not allow small children to reach objects located on the upper shelves by themselves.
- Do not climb on the lower shelves to reach objects on the upper shelves.
- Do not expose the surfaces to direct sunlight or to extreme environmental conditions.
- Clean the surfaces preferable with a clean cloth damped in a solution of mild soap and water, then dry with a clean towel.
- Do not use solvents or abrasive materials to clean the unit.
- If you decide to use a cleaning agent, test first on an area hidden from view such as underneath the tabletop.
- If you have to move the unit, detach it from the anchoring device first.
- Before moving the unit, make sure to secure or remove any object that is heavy or might fall off. It is recommended to remove all objects from the top shelves.
- Have a second adult person help you move the unit, and please be very careful when doing so as to avoid tipping-over accidents.
- If you lift the unit, use both hands and bend your knees, not your backs.
- When transporting the unit to places far away, protect and secure the unit to avoid damage in transit.
- Shall any part of the unit become defective during the warranty period, replacement parts might be available to you at no charge. Please refer to the last pages on this manual.
- The warranty does not extend to regular wear and tear, nor the manufacturer assumes liability for damages or consequences due to accidents, incorrect assembly, negligence, improper use, modifications, or not heeding the above warnings.

**TECHNI MOBILI WARRANTY**  
**DESKS/LAPTOP CARTS/FILE CABINETS: LIMITED 5-YEAR WARRANTY**  
**TV Stand/Entertainment Center: 2 YEAR WARRANTY**

RTA Products, LLC warrants to the Original Purchaser who acquired a new product from RTA Products or its authorized resellers that this product will be free from defects in its workmanship and materials, under normal use and service conditions, as described herein. "Defects" as used in this warranty, is defined as any imperfections that impair the use of the furniture or product. RTA Products LLC will replace any defective part, at its discretion, and without charge to the original purchaser other than the freight from the end consumer to RTA Products.

Replacement parts can only be supplied if parts are available. Items out of production may be unavailable. This warranty will be effective for the applicable time period beginning the date of purchase on your original sales receipt. RTA product's obligation under this warranty is limited to repairing or replacing products or parts as provided herein. This product has been designed for and is intended for office and home-office use only. This warranty is Original Purchaser's sole remedy for product defects, and this warranty does not extend to any product, or damage to any product, caused by or attributed to abuse or misuse, products used for commercial or rental purposes, use modifications of, or attachments to the product, and products or parts not used, maintained, or extended hereunder is in lieu of any and all other warranties, express or implied, including without limitations any implied warranty or merchantability or of fitness for a particular purpose. Please note, all desks made with PVC Laminate surface should not be exposed to direct sunlight, as it may damage the material. Damage of this nature is not covered under this warranty.

RTA Products will not be responsible for indirect, special, incidental or consequential damages. This warranty is limited to merchandise purchased in the Continental United States. Some States do not allow the exclusion or limitation of incidental or consequential damages, so the above limitations or exclusions may not apply to you. This warranty gives you specific legal rights. You may also have other rights that may vary from state to state.

RTA Products will advise you of the procedure to follow in making warranty claims. The following are the procedures for warranty claims:

- a. Call us Monday – Friday, from 9am-5pm (Eastern Time) at (866) 782-5520 to explain the defect and give your name, address and phone number. Please have ready the model number of our product, date and place of purchase. You can also write to us by e-mail to [warranty@rtaproducts.com](mailto:warranty@rtaproducts.com) and include the same information.
- b. If we determine that replacement will remedy the situation, and in order to determine the extent or the cause of the defect, purchaser will need to send the part in question at purchaser's expense. Once we receive the part, we will examine it and determine whether the claim is valid (or not), and then proceed to send the replacement. We will ship the replacement at our expense.

# FOR SEVERAL HELP OPTIONS INCLUDING REPLACEMENT PARTS ORDERS

---

VISIT: [WWW.TECHNIMOBILI.COM](http://WWW.TECHNIMOBILI.COM)



CLICK ON SUPPORT TAB



Scan QR Code to order replacement parts

OR EMAIL US: [SUPPORT@RTAPRODUCTS.COM](mailto:SUPPORT@RTAPRODUCTS.COM)

## STEP 12

## Hardware:

C



M6x25

4  
Pcs

Secure the side panels **11** and **12** to the structure **1** with screws **C** from the inside.

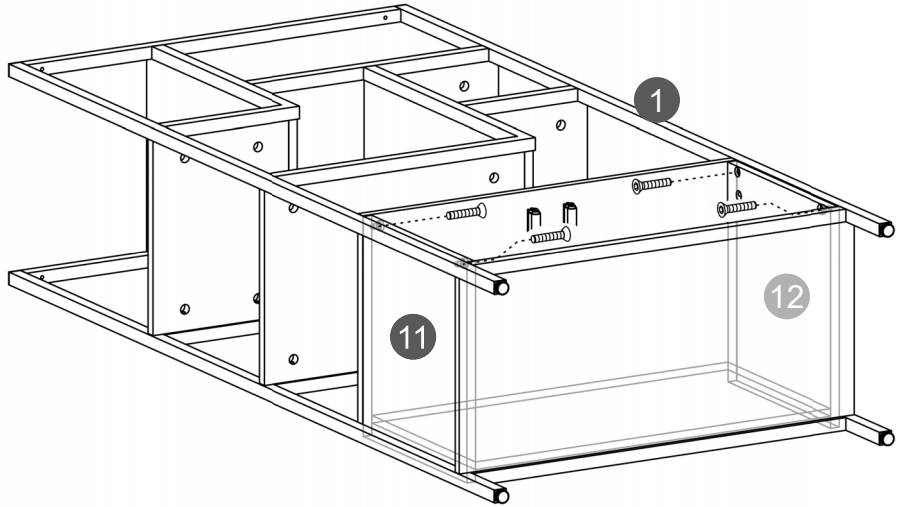

## STEP 13

## Hardware:

C



M6x25

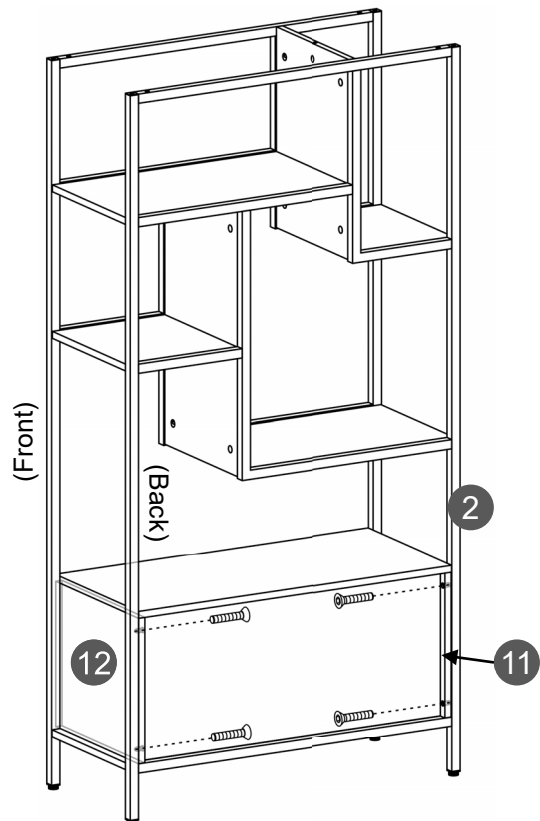
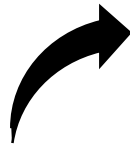
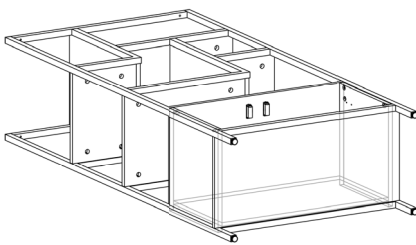

4  
Pcs

- With the help of another person bring the frame upright.
- Secure the side panels **11** and **12** to the back structure **2** with screws **C** from the inside.



**STEP 14**

**Hardware:**

<b>A</b>		1 Pcs
<b>D</b>		4 Pcs

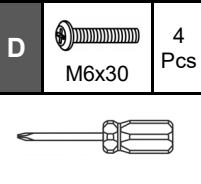

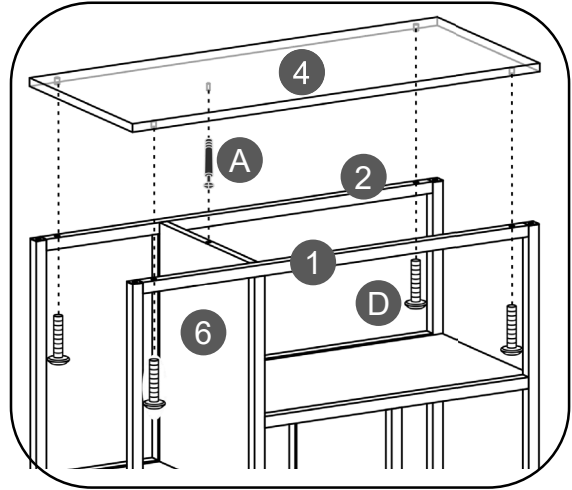
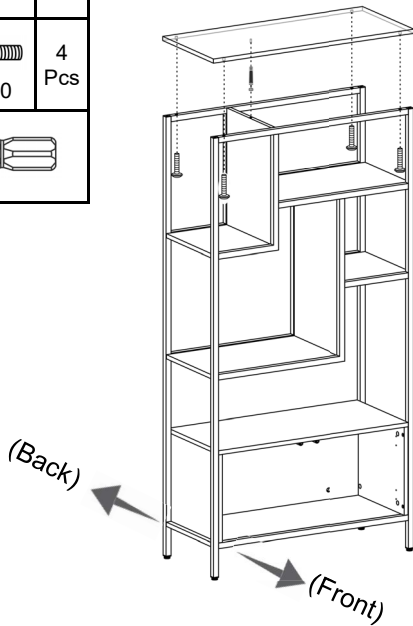

- Attach the remaining bolt **A** to the top panel **4** on the center hole.
- Assemble panel **4** to the Upper left divider **6** as shown and as explained in page 4.
- Secure panel **4** to structures **1** and **2** with screws **D** from underneath.



**STEP 15**

**Hardware:**

<b>F</b>		8 Pcs
----------	---	-------

<b>18</b>		2 Pcs
-----------	---	-------

<b>19 C</b>		
-------------	---	--

<b>19 D</b>		
-------------	---	--

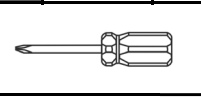

- Attach the metal disk **19C** from the Spring kit **19** to the doors **16** and **17** with the screws **19D**.
- Attach the Hinges **18** to the doors with screws **F**.

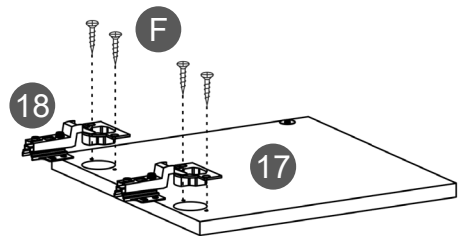
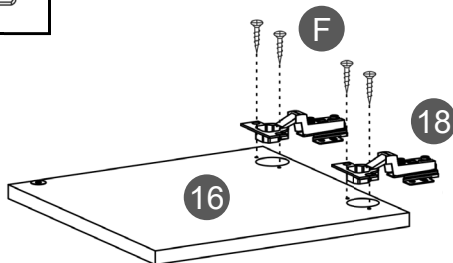
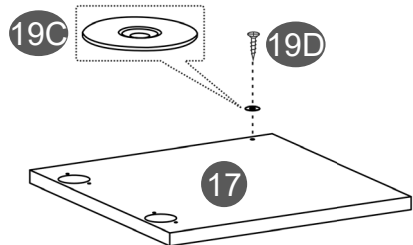
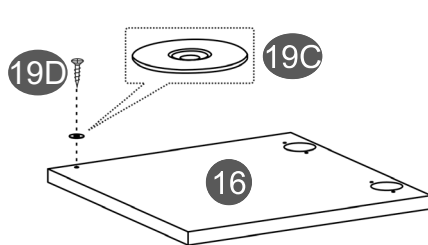

## STEP 16

## Hardware:

F

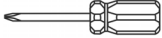
16  
Pcs

- With the help of another person, install the Door **16** to the Lower left panel **11** by attaching the Hinges **18** with screws **F** only on the oval holes.
- Install the Door **17** to the Lower right panel **12** by attaching the Hinges **18** with screws **F** only on the oval holes.

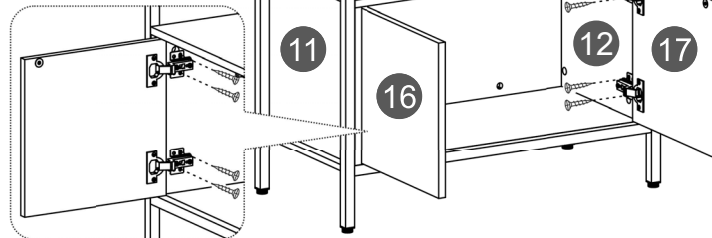
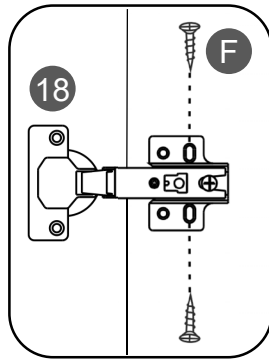

- If the doors are not closing properly or need alignment, proceed to do the following adjustments:

- Loosen these screws to adjust the height of the door.
- Loosen this screw to adjust the depth of the door.
- Turn this screw either way to adjust the door side-to-side.

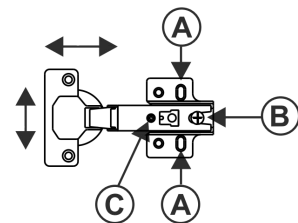

- After the adjustments are done, you can secure the hinges to the side panels with the rest of screws **F** on the round holes.

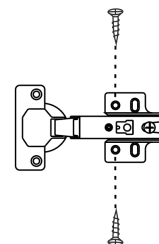



**STEP 17**

**Hardware:**

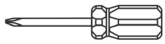
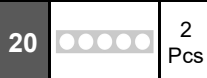
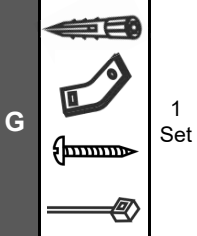

- Once you have selected the place against the wall where the unit will go, with the help of another person bring the unit closer to the wall, and calculate the 2 points on the wall where the anchor device **G** will be installed, which should be **no more than 1 inch away** from the top corners of the unit.
- Mark the points on the wall and with the appropriate tools make a hole to install the **anchors** from the kit **G**.
- Attach the **brackets** from the kit **G** to the anchors with the screws that come in the same kit.
- Use the **tie downs** from the kit **G** to secure the frame to the brackets.

**Securing the unit to the wall prevents accidents from tip-overs.**

- Cover all the cam locks on panels **6** and **9** with stickers **20**.

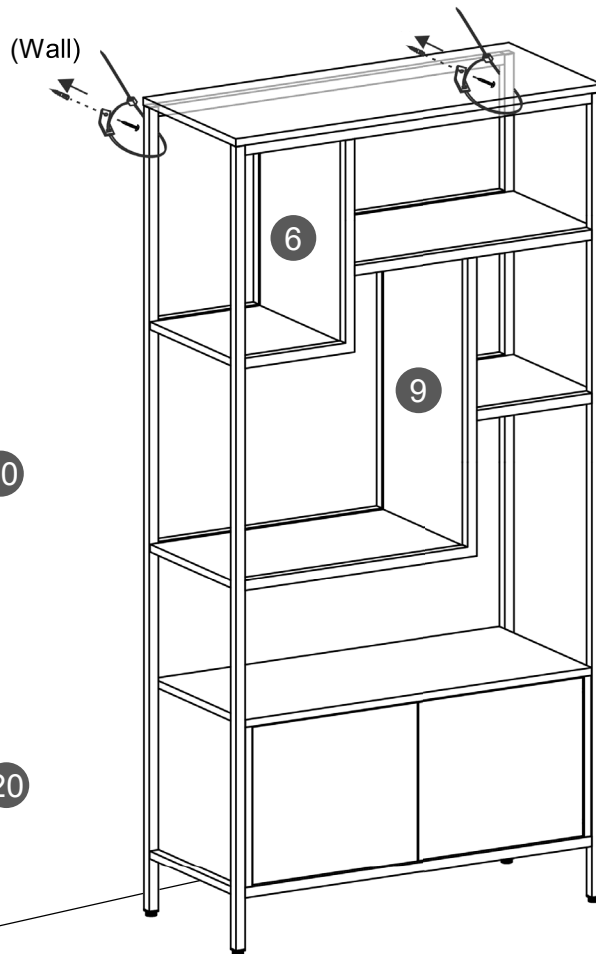
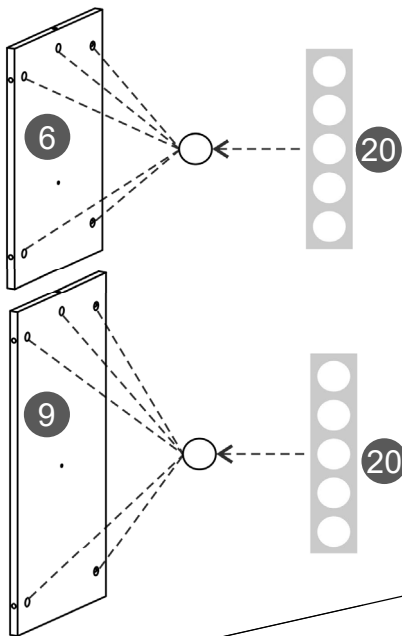
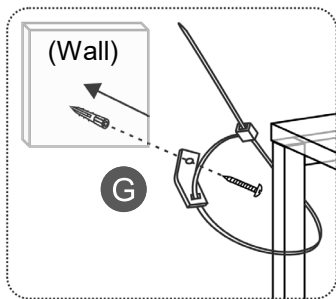

# ALL DONE!

Give yourself a nice pat on the back. You did a great job!

**IT IS EXTREMELY IMPORTANT  
THAT YOU READ ALL THE  
WARNINGS ON THE NEXT PAGE!**

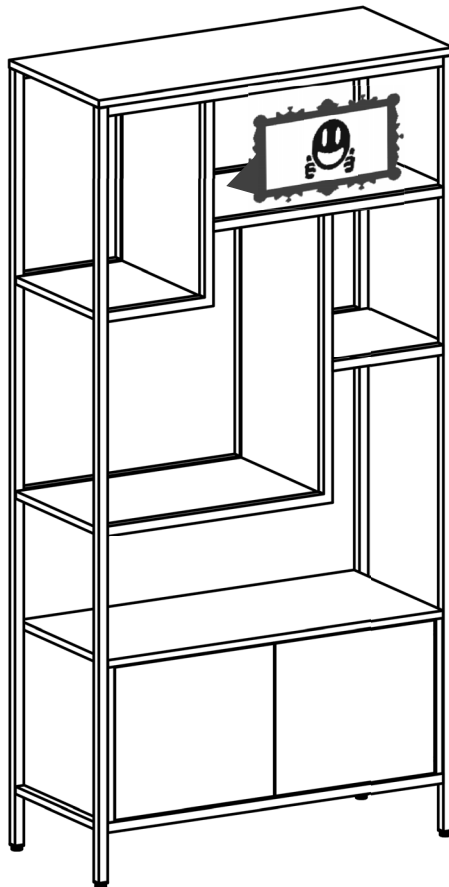

## TIP-OVER WARNING!

Please keep your children and yourself safe. Tip-over accidents can result in serious injuries or be fatal to small children.

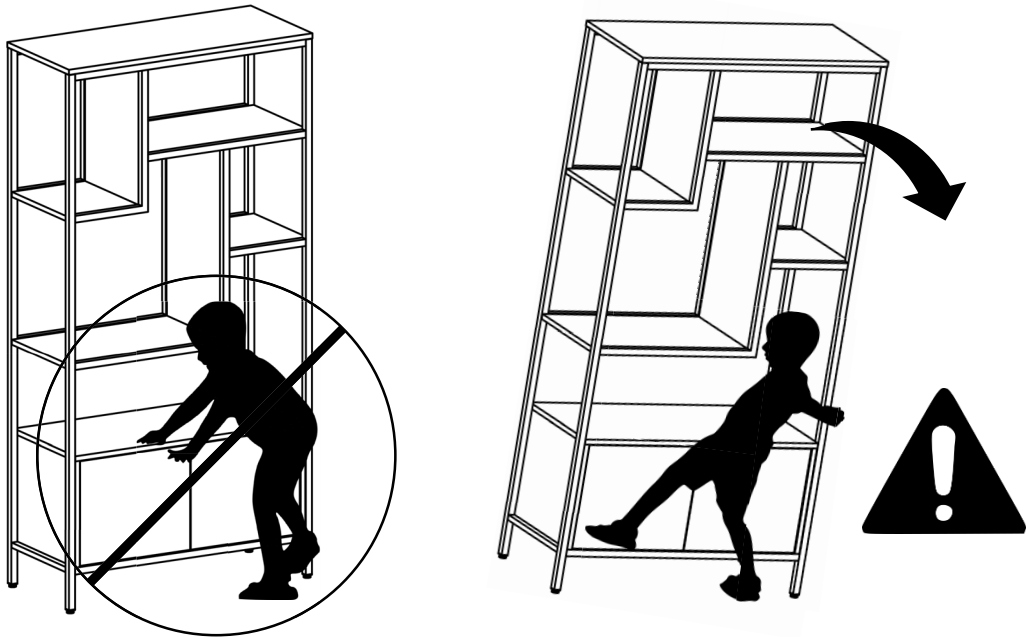

### PREVENT TIP-OVER ACCIDENTS BY FOLLOWING THESE RECOMMENDATIONS:

1. Secure the unit by anchoring it to the wall. The anchoring device has been provided with the unit, and must be installed by following the instructions shown in PAGE 14 of this manual.
2. Once the unit has been anchored, load the heavier objects onto the lower shelves, and the lighter objects to the upper shelves.
3. Never reach the objects on the upper shelves by climbing on the lower shelves.
4. Do not let children climb on the shelves to reach objects located on the upper shelves, an adult should always grab the objects for them.
5. Do not let children play on any empty shelf or inside the lower cabinet.

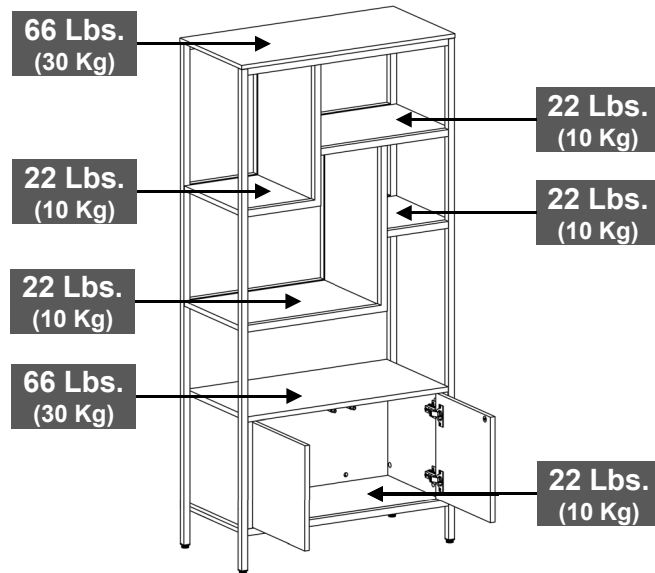
**CARE, MAINTENANCE AND SAFETY WARNINGS:****WEIGHT LIMITS**

- For the safety of small children and your own, secure the unit to the wall with the anchor device provided.
- Do not exceed the indicated weight limits.
- Always load the heavy objects on the lower shelves.
- Do not allow small children to climb or play on the shelves or inside the lower cabinet.
- Do not allow small children to reach objects located on the upper shelves by themselves.
- Do not climb on the lower shelves to reach objects on the upper shelves.
- Do not expose the surfaces to direct sunlight or to extreme environmental conditions.
- Clean the surfaces preferable with a clean cloth damped in a solution of mild soap and water, then dry with a clean towel.
- Do not use solvents or abrasive materials to clean the unit.
- If you decide to use a cleaning agent, test first on an area hidden from view such as underneath the tabletop.
- If you have to move the unit, detach it from the anchoring device first.
- Before moving the unit, make sure to secure or remove any object that is heavy or might fall off. It is recommended to remove all objects from the top shelves.
- Have a second adult person help you move the unit, and please be very careful when doing so as to avoid tipping-over accidents.
- If you lift the unit, use both hands and bend your knees, not your backs.
- When transporting the unit to places far away, protect and secure the unit to avoid damage in transit.
- Shall any part of the unit become defective during the warranty period, replacement parts might be available to you at no charge. Please refer to the last pages on this manual.
- The warranty does not extend to regular wear and tear, nor the manufacturer assumes liability for damages or consequences due to accidents, incorrect assembly, negligence, improper use, modifications, or not heeding the above warnings.

# FOR SEVERAL HELP OPTIONS INCLUDING REPLACEMENT PARTS ORDERS

---

VISIT: [WWW.TECHNIMOBILI.COM](http://WWW.TECHNIMOBILI.COM)



CLICK ON SUPPORT TAB



Scan QR Code to order replacement parts

OR EMAIL US: [SUPPORT@RTAPRODUCTS.COM](mailto:SUPPORT@RTAPRODUCTS.COM)