

ASSEMBLY INSTRUCTIONS

CHAIR STYLE RTA-1008

PARTS LIST

ATTENTION: Before you begin to assemble the product, please make sure that all the parts are included in the package and in good condition.

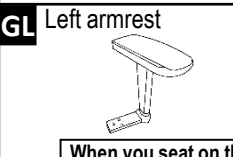
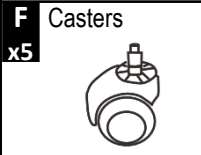
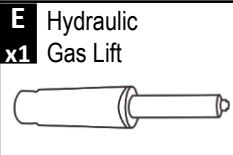
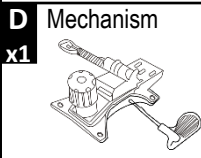
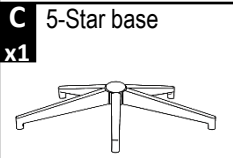
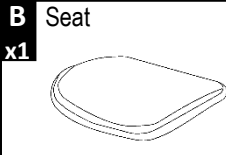
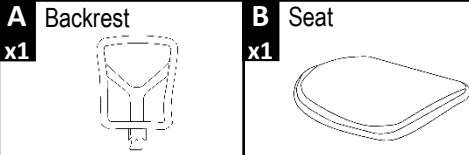

When you seat on the chair, not looking at it.

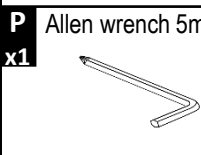
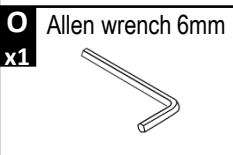
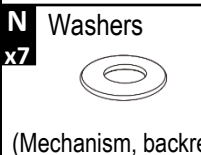
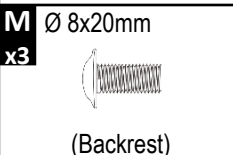
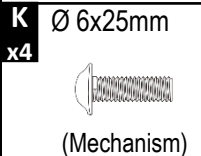
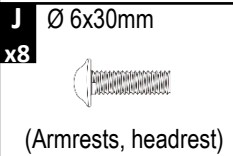
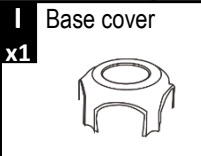

ATTENTION:

- Follow the instructions step by step.
- To avoid misalignments, leave the screws loose and do not tighten them until all are in their respective places.
- Do not overtighten or force the screws as they could break, strip, or damage the threads of the holes.
- Using the wrong size of screws on a part could result in damage to the screw or the part

1 Insert the casters (F) in the legs of the base (C) using pressure, then place the gas lift (E) and the cover (J) in the middle of the base as shown.

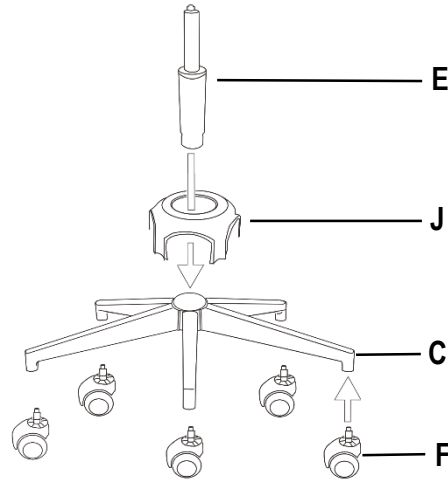

2 Flip over the seat (B) with its front towards you and assemble the armrests (G) in the respective sides using screws (J) as shown.

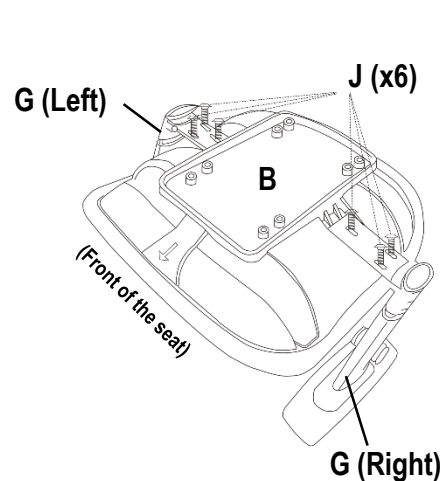

3 Using screws (K) and washers (N), assemble the mechanism (D) to the seat (B) with its knob facing to the FRONT as shown.

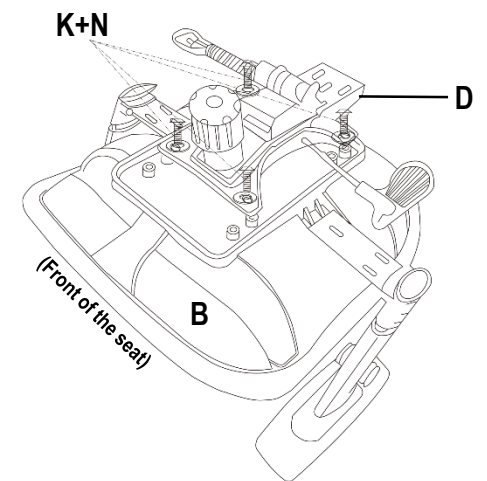

4 Assemble the backrest (A) to the mechanism (D) using screws (M) and washers (N) as shown.

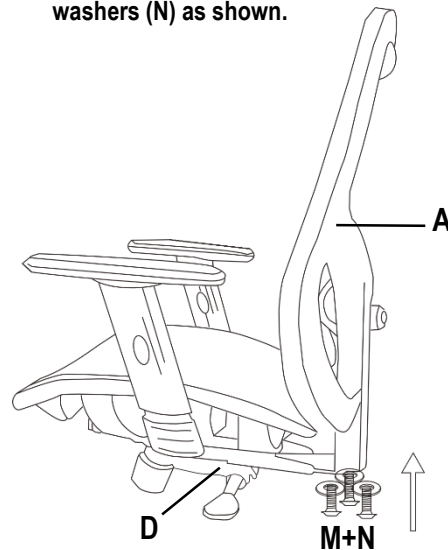

5 Place the top parts over the base parts making sure the tip of the gas lift enters into the hole of the mechanism.

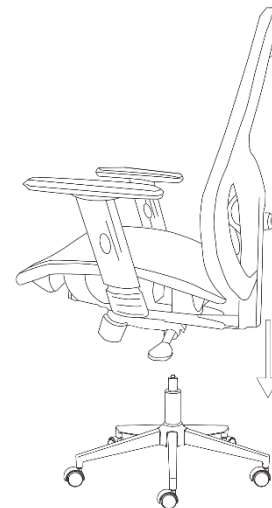

6 Assemble the headrest (H) to the backrest (A) using screws (J) as shown.

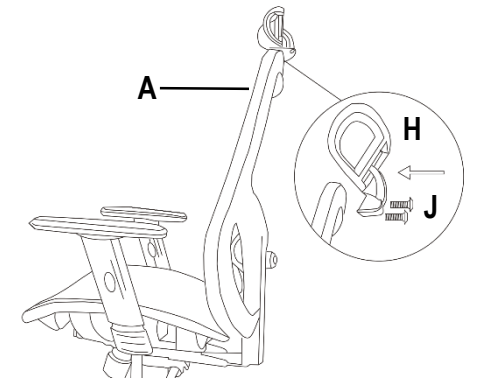

Before seating and using the chair for the first time, make sure that all screws are properly tightened.

CHAIR'S FUNCTIONS:

- (1) Chair height: Pull UP the lever located under the seat on your RIGHT. The chair goes down while sitting on it, or up if you lift your body.
- (2) Backrest reclining: Pull UP the lever located under the seat on your LEFT. Recline the backrest and release the lever when the desired position is reached.
- (3) Reclining tension: Turn the mechanism's knob in either direction to apply more or less tension to the reclining function.
- (4) Armrest height: Push the buttons that are on the armrests and release them once the desired height is reached.
- (5) The headrest can move UP and DOWN as well as tilt FRONT-BACK.
- (6) The lumbar support can adjust FORWARD and BACKWARDS.

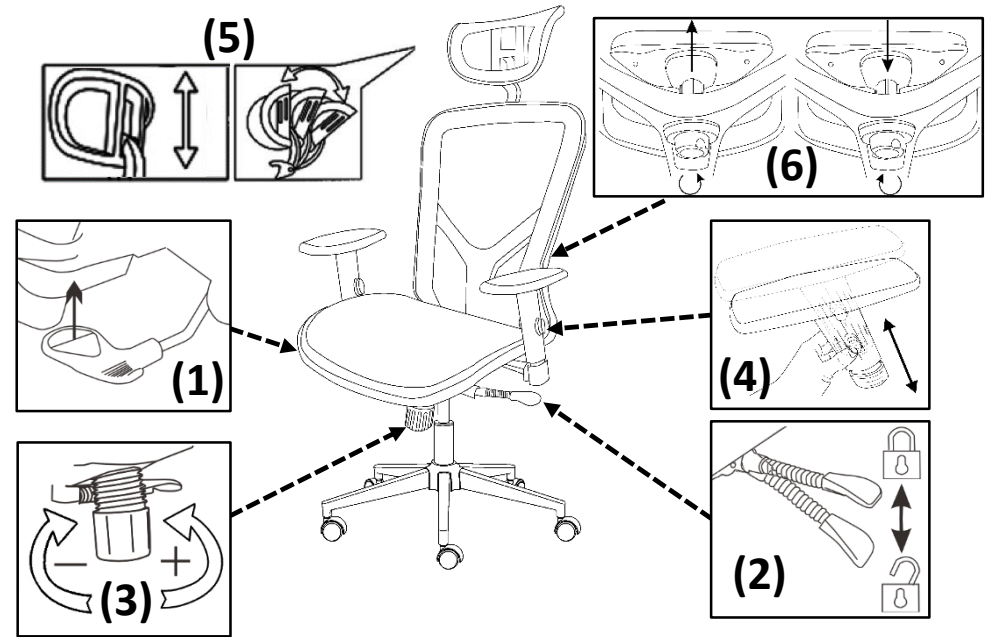

WARNINGS:

- Do not stand up on the chair or use it as ladder.
- Use the chair to seat only one person at a time.
- Do not use the chair if parts are damaged or if screws are loose or missing.
- Do not seat near the edge of the seat and always sit properly on the chair to avoid going beyond your balance point and fall off the chair.
- The chair is intended for teenagers and adults. If small children are using the chair, please keep close observation on them.
- Do not allow small children to play with the chair.
- Not paying attention to these warnings could result in severe injuries.

CUCARE AND MAINTENANCE:

- To clean the chair it is recommended to use a soft cloth lightly damped in a solution of smooth soap and water, then dry with a clean towel.
- Do not use solvents or abrasive materials to clean any part of the chair.
- Before applying a cleaning agent, test on a small hidden area of the chair, like underneath the seat.
- Do not expose the product to direct sunlight or to extreme environmental conditions.
- Every 4 months, inspect the chair completely and make sure that all screws are tighten.