











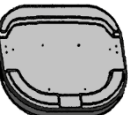

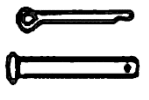
ASSEMBLY INSTRUCTIONS

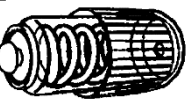
CHAIR STYLE RTA-0097M

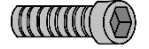
PARTS LIST

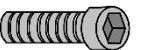
ATTENTION: Before you begin to assemble the product, please make sure that all the parts are included in the package and in good condition.

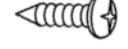
| | |
|--|--|
| A x1 Backrest  | H x1 Covers for Gas Lift (Set)  |
| B x1 Seat  | I x1 Backrest support with plastic covers  |
| C x1 Star Base  | J x1 Lock Pin Set (Mechanism)  |
| D x1 Mechanism  | K x1 Spring Knob  |
| E x1 Hydraulic Gas Lift  | L x4 Screws 6x16mm (Mechanism)  |
| F x5 Casters  | M x10 Screws 6x25mm (Backrest, Armrests)  |
| G x2 Armrest  | N x1 Allen wrench  |
| | O x4 Screw 10mm (Backrest covers)  |

- Follow the instructions step by step.
- To avoid misalignments, leave the screws loose and do not tighten them until all are in their respective places.
- Do not overtighten or force the screws as they could break, strip, or damage the threads of the holes.
- Using the wrong size of screws on a part could result in damage to the screw or the part

ATTENTION:

1 Insert the casters (F) in the legs of the base (C) using pressure, then place the gas lift (E) in the middle of the base and cover it with (H) as shown.

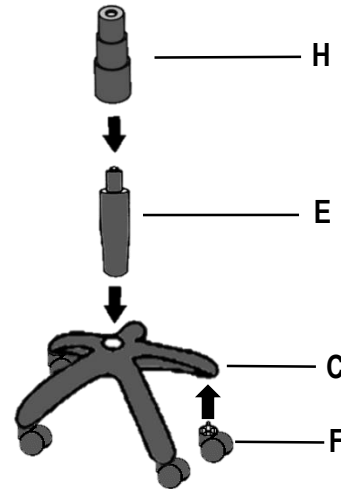

2 Assemble the support (I) to the backrest (A) using screws (M) and attach the covers using screws (O) as shown.

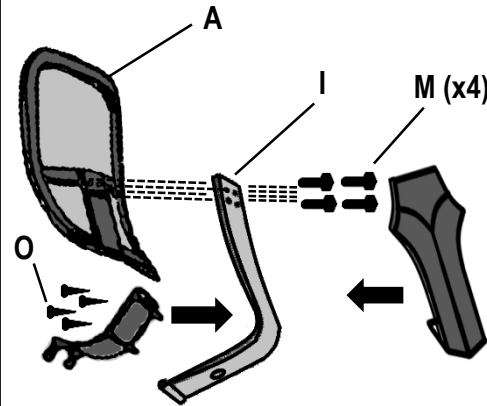

3 Assemble the mechanism (D) to the support (I) by inserting the lock pin set (J) and bending the pin as shown.

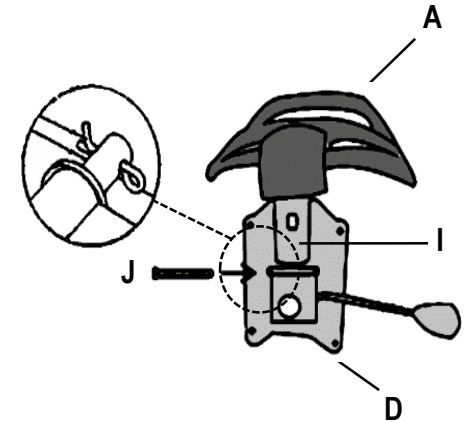

4 Disassemble the spring knob (K):

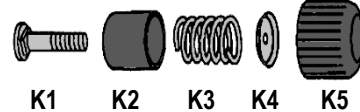

Then insert its bolt (K1) thru the small hole on the mechanism (D) from underneath as shown, and re-assemble **IN THE EXACT ORDER SHOWN IN THE ILLUSTRATION.**

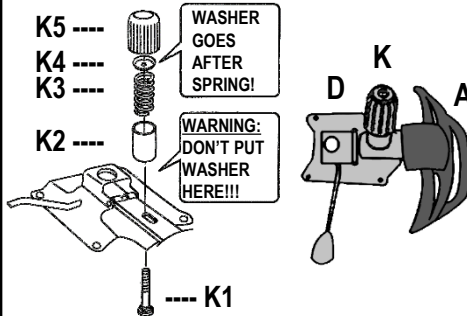

5 Assemble to the seat (B):

- The mechanism (D) using screws (L).
- The armrests (G) using screws (M).

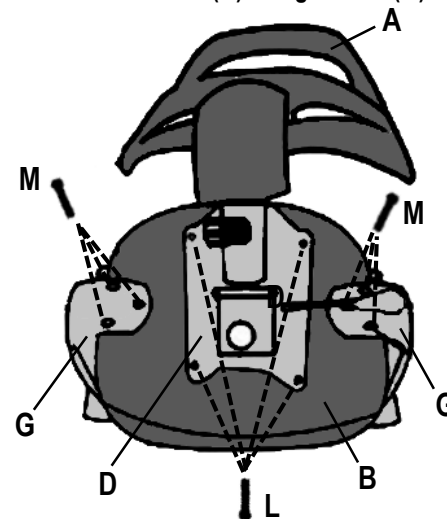

6 Place the top parts over the base parts making sure the tip of the gas lift enters into the hole of the mechanism.

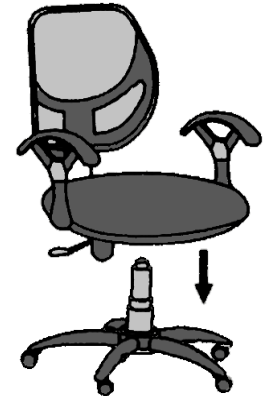

Before seating and using the chair for the first time, make sure that all screws are properly tightened.

CHAIR'S FUNCTIONS:

- (1) Chair height: Pull UP the lever that is under the seat. The chair goes down while sitting on it, or up if you lift your body.
- (2) Backrest tilting: Turn the mechanism's spring knob in either direction to apply more or less tension.

WARNING: Please make sure the spring knob was assembled exactly as explained on step 3, otherwise it might detach causing serious injuries.

WARNING: When adjusting the spring knob for less tension, make sure the bolt is still holding the rest of the assembly together, otherwise, the knob might detach causing serious injuries.

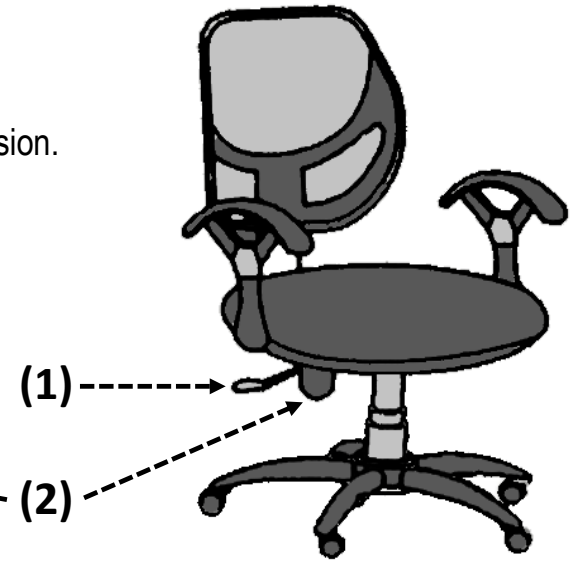
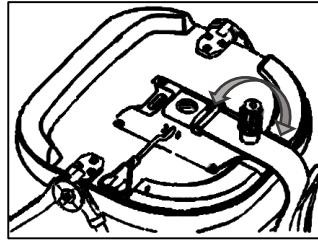

WARNINGS:

- Do not stand up on the chair or use it as ladder.
- Use the chair to seat only one person at a time.
- Do not use the chair if parts are damaged or if screws are loose or missing.
- Do not seat near the edge of the seat and always sit properly on the chair to avoid going beyond your balance point and fall off the chair.
- The chair is intended for teenagers and adults. If small children are using the chair, please keep close observation on them.
- Do not allow small children to play with the chair.
- Not paying attention to these warnings could result in severe injuries.

CUCARE AND MAINTENANCE:

- To clean the chair it is recommended to use a soft cloth lightly damped in a solution of smooth soap and water, then dry with a clean towel.
- Do not use solvents or abrasive materials to clean any part of the chair.
- Before applying a cleaning agent, test on a small hidden area of the chair, like underneath the seat.
- Do not expose the product to direct sunlight or to extreme environmental conditions.
- Every 4 months, inspect the chair completely and make sure that all screws are tighten.