

BLISS BSL60S

Sink: BSL60SSINK

Dimensions:	width	depth	height
inches	59"	18.5"	23.75"
mm	1499	470	603

NOTE: DIMENSIONS AND TECHNICAL DETAILS ARE SUBJECT TO CHANGE WITHOUT NOTICE

. FRONT ELEVATION

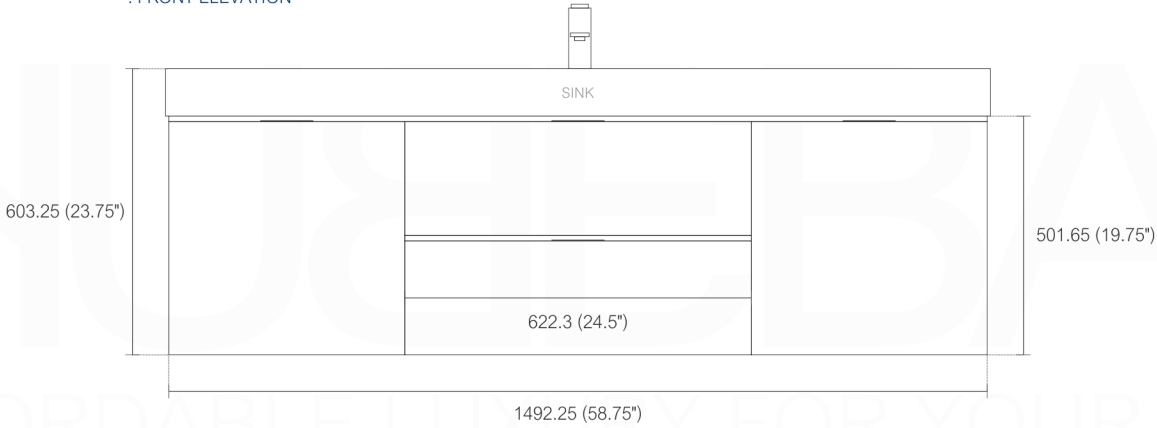

. BACK ELEVATION

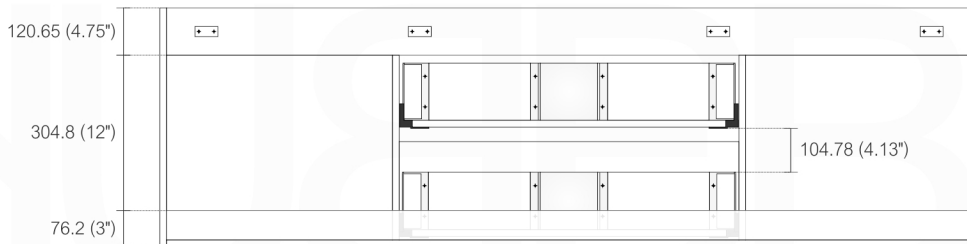

. TOP ELEVATION

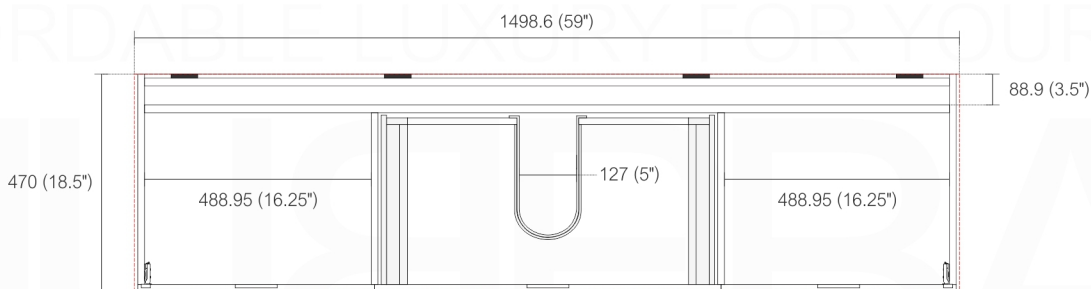

. Adjustments

The options for height adjustment depend on the type of base plate. All adjustments can be made independent of one another.

For depth adjustment, select base plates have worm gear adjustment access through the hinge arm.

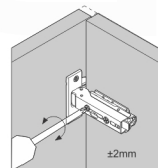

Side adjustment

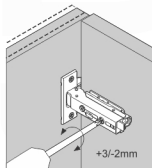

Depth adjustment via worm gear

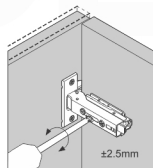

Height adjustment via base plate

. Reveal

The reveal (R) is the distance required between two doors or between the door and side wall of the cabinet to allow sufficient space for opening the door. The required reveal width (R) depends on the thickness of the door.

Most cabinet makers prefer a reveal (R) of between 3mm and 6mm.

Full Overlay/Overlay Door

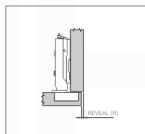

Half Overlay Door

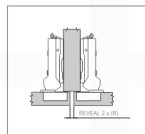

Inset Door

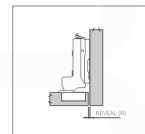

NOTE: DIMENSIONS AND TECHNICAL DETAILS ARE SUBJECT TO CHANGE WITHOUT NOTICE

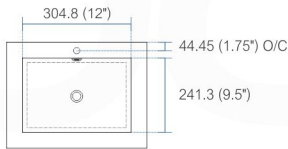

product code
BSL16SINK

Thickness: 9.53 (0.38")

Dimensions:	width	length	height	depth
inches	16.0"	16.0"	4.0"	3.38"
mm	406.4	406.4	101.6	85.73

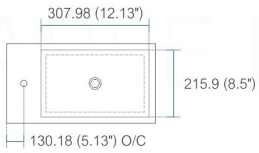

product code
BSL18SINK

Thickness: 9.53 (0.38")

Dimensions:	width	length	height	depth
inches	18.0"	10.25"	4.0"	3.38"
mm	457.2	257.18	101.6	85.73

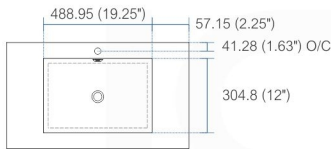

product code
BSL24SINK

Thickness: 9.53 (0.38")

Dimensions:	width	length	height	depth
inches	23.63"	18.5"	4.0"	4.0"
mm	600.08	469.9	101.6	101.6

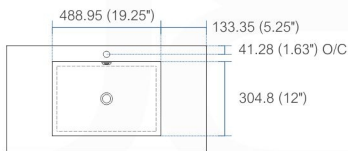

product code
BSL30SINK

Thickness: 9.53 (0.38")

Dimensions:	width	length	height	depth
inches	29.5"	18.5"	4.0"	4.0"
mm	749.3	469.9	101.6	101.6

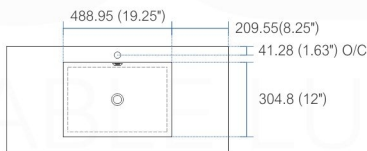

product code
BSL36SINK

Thickness: 9.53 (0.38")

Dimensions:	width	length	height	depth
inches	35.75"	18.5"	4.0"	4.0"
mm	908.05	469.9	101.6	101.6

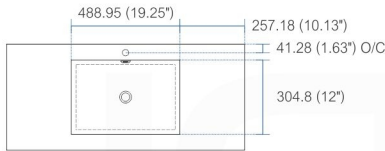

product code
BSL40SINK

Thickness: 9.53 (0.38")

Dimensions:	width	length	height	depth
inches	39.5"	18.5"	4.0"	4.0"
mm	1003.3	469.9	101.6	101.6

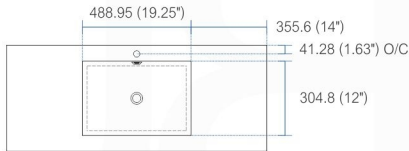

product code
BSL48SINK

Thickness: 9.53 (0.38")

Dimensions:	width	length	height	depth
inches	47.25"	18.5"	4.0"	4.0"
mm	1200.15	469.9	101.6	101.6

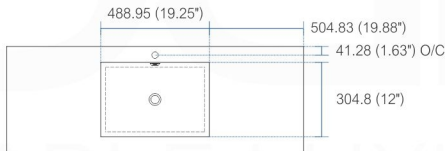

product code
BSL60SSINK

Thickness: 9.53 (0.38")

Dimensions:	width	length	height	depth
inches	59"	18.5"	4.0"	4.0"
mm	1498.6	469.9	101.6	101.6

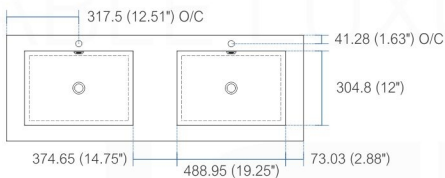

product code
BSL60DSINK

Thickness: 9.53 (0.38")

Dimensions:	width	length	height	depth
inches	59"	18.5"	4.0"	3.75"
mm	1498.6	469.9	101.6	95.25

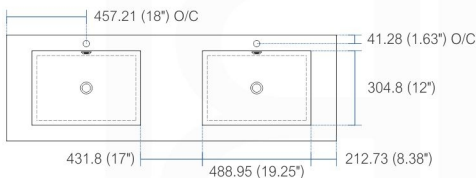

product code
BSL72SINK

Thickness: 9.53 (0.38")

Dimensions:	width	length	height	depth
inches	71.63"	18.5"	4.0"	4.0"
mm	1819.28	469.9	101.6	101.6

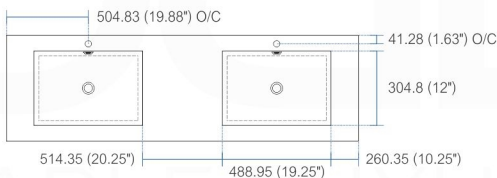

product code
BSL80SINK

Thickness: 9.53 (0.38")

Dimensions:	width	length	height	depth
inches	79"	18.5"	4.0"	4.0"
mm	2006.6	469.9	101.6	101.6

Vanity cabinet | removing+adjusting drawers

To remove the drawer/s

- * Extend the drawer
- * Look for the release levers under the drawer, on the sliding bar
- * To release and remove drawer, simultaneously push the drawer release levers upwards (both sides at the same time) and slide/lift the drawer away from the tracks.
- * Repeat for each drawer

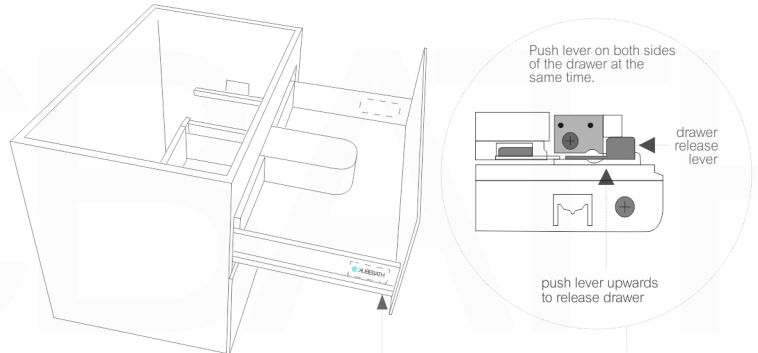

To replace the drawer/s

- * Fully extend the drawer runner on each side of the cabinet
- * Place the drawer onto the runners ensuring that the drawer is levelled on the tracks, and continue to hold in place (otherwise, the drawer will fall).
- * Keeping the drawer levelled, gently push the drawer along the runners into the cabinet until you hear a click.

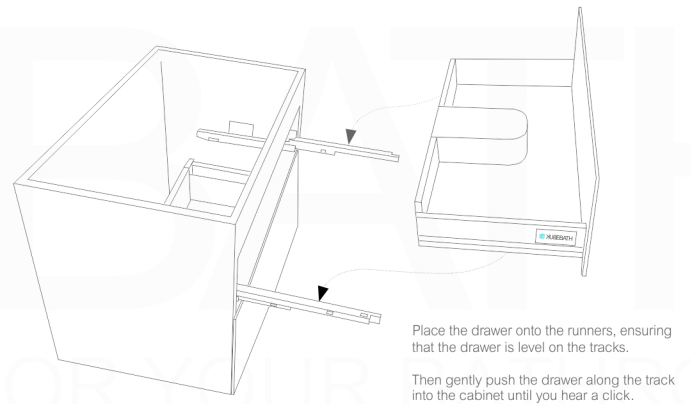

To adjust the drawer/s

- * To move the drawer up or down, turn the side screw located under the cover plate on each side of the drawer.

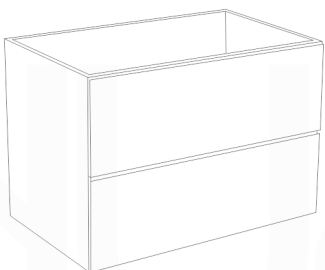
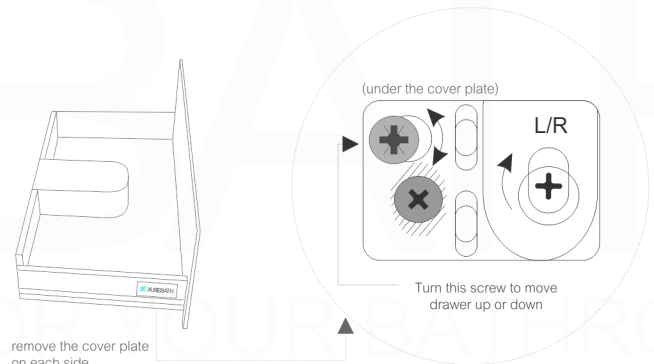

These instructions show a vanity cabinet with two drawers. However, the instructions apply to all cabinets and all sizes of the Bliss Vanity Line. The characteristics and drawer mechanisms are the same for all units.

How to Install a Bliss Wall-Hung Vanity INSTALLATION GUIDE

Tools Required for Assembly

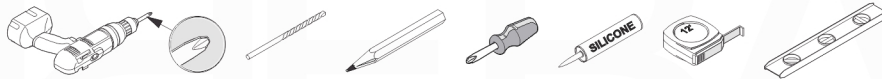

Wall Preparation

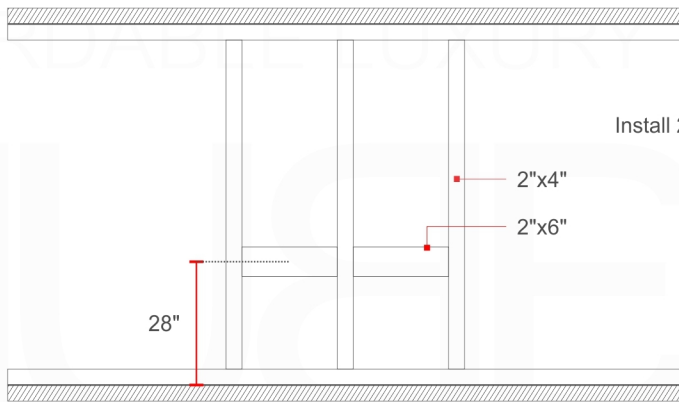

Install 2"x 6" lumber between the wall studs. Desired height: 28".

Vanity Installation

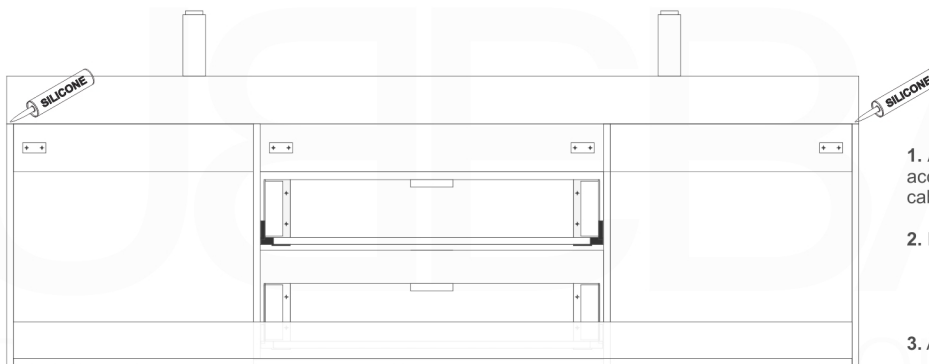

1. Align and level mounting Brackets according to horizontally reinforcement lumber and desired cabinet height.
2. Mount Vanity on to the wall brackets.
3. Add a dap of silicone to the corners of the Cabinet.
4. Gently position and align Counter top Sink onto Vanity.

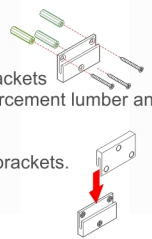

Pop-Up / P-trap Installation Instructions INSTALLATION GUIDE

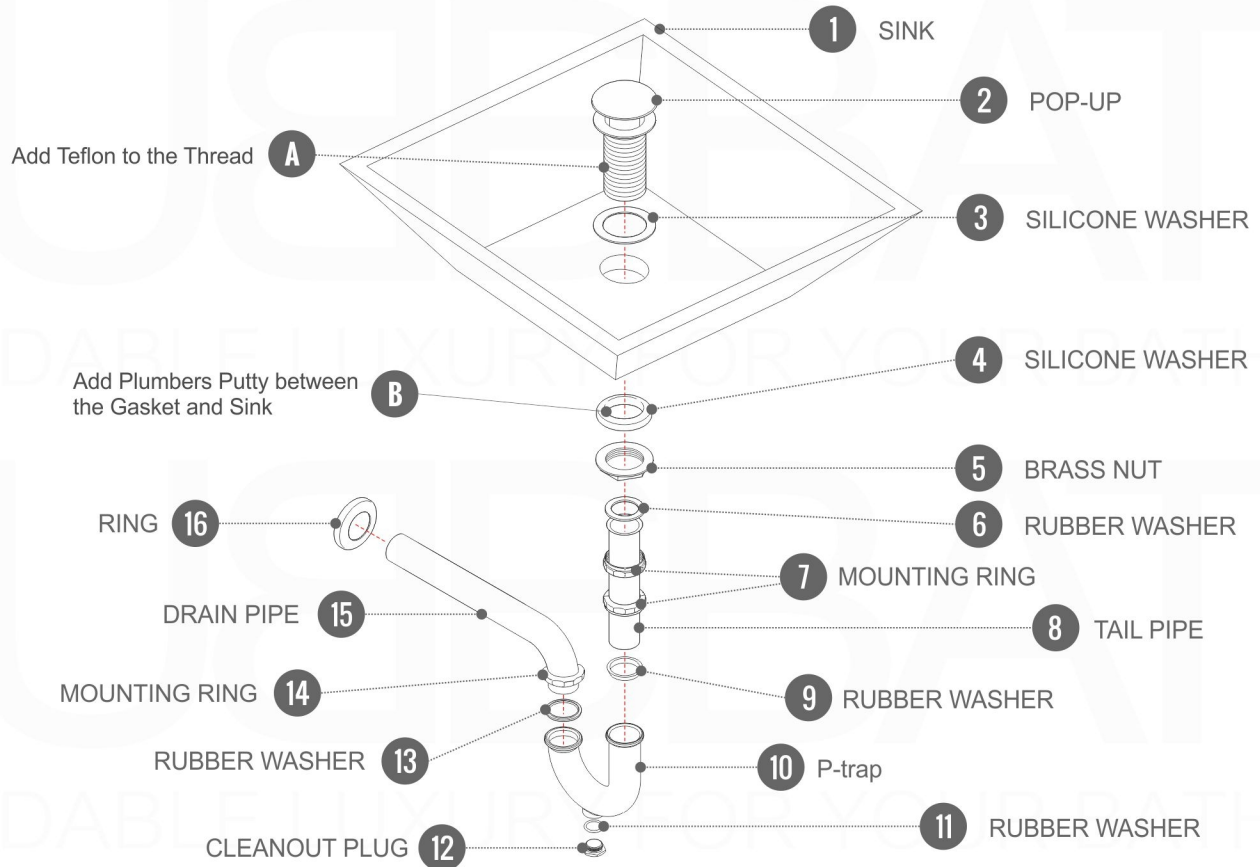

FOR SINKS WITHOUT OVERFLOW
#SKU: P101N / P102N

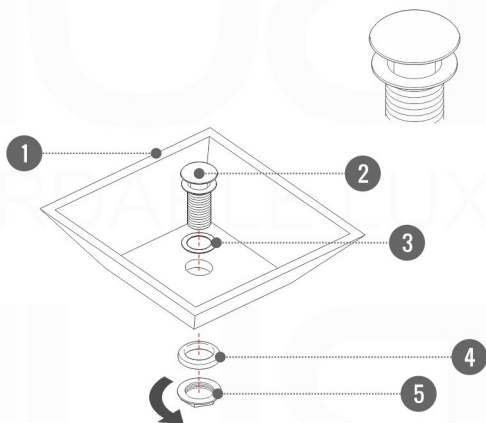

FOR SINKS WITHOUT OVERFLOW
#SKU: P101 / P102

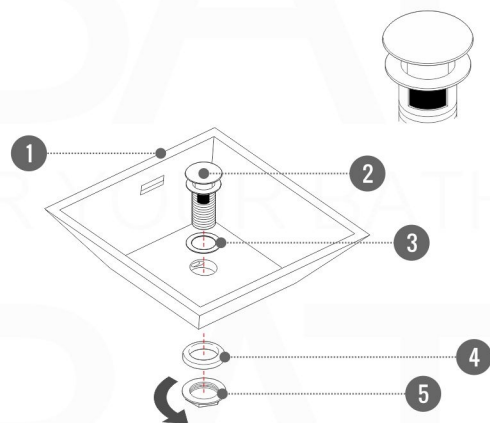

OR