

# BLISS BSL24

Sink: BSL24SINK

Dimensions:	width	depth	height
inches	23.63"	18.5"	23.75"
mm	600	470	603

NOTE: DIMENSIONS AND TECHNICAL DETAILS ARE SUBJECT TO CHANGE WITHOUT NOTICE

FRONT ELEVATION

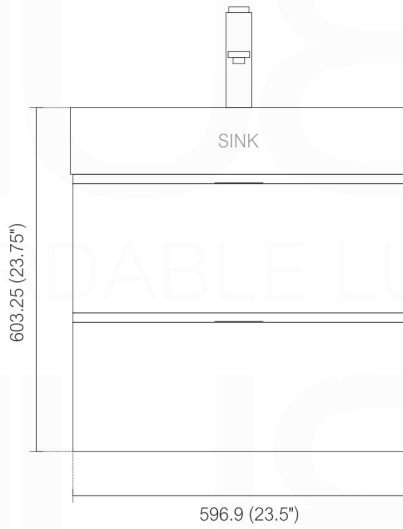

BACK ELEVATION

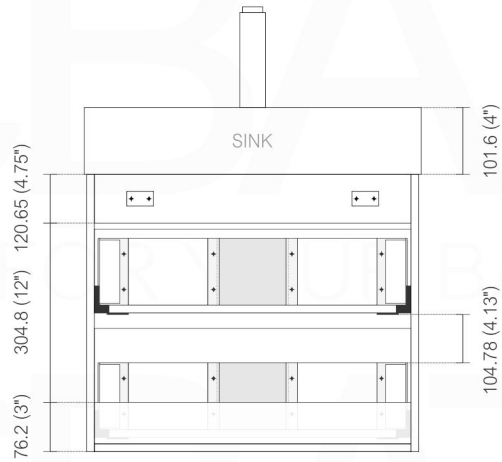

TOP ELEVATION

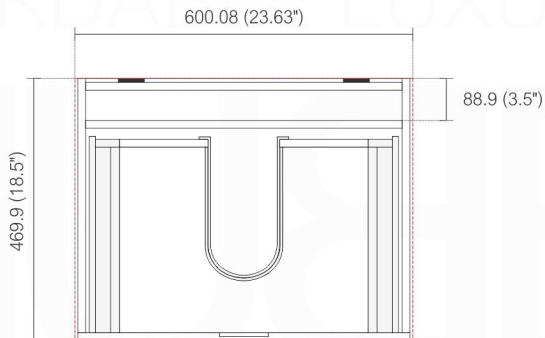

NOTE: DIMENSIONS AND TECHNICAL DETAILS ARE SUBJECT TO CHANGE WITHOUT NOTICE

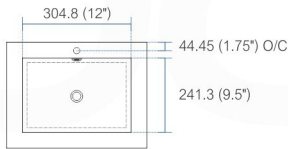

product code  
BSL16SINK

Thickness: 9.53 (0.38")

Dimensions:	width	length	height	depth
inches	16.0"	16.0"	4.0"	3.38"
mm	406.4	406.4	101.6	85.73

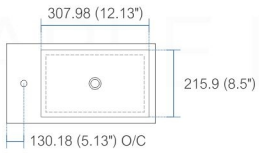

product code  
BSL18SINK

Thickness: 9.53 (0.38")

Dimensions:	width	length	height	depth
inches	18.0"	10.25"	4.0"	3.38"
mm	457.2	257.18	101.6	85.73

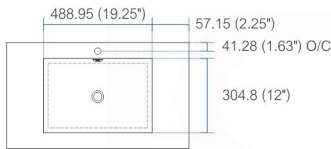

product code  
BSL24SINK

Thickness: 9.53 (0.38")

Dimensions:	width	length	height	depth
inches	23.63"	18.5"	4.0"	4.0"
mm	600.08	469.9	101.6	101.6

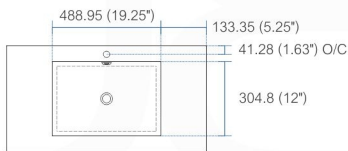

product code  
BSL30SINK

Thickness: 9.53 (0.38")

Dimensions:	width	length	height	depth
inches	29.5"	18.5"	4.0"	4.0"
mm	749.3	469.9	101.6	101.6

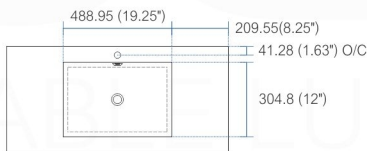

product code  
BSL36SINK

Thickness: 9.53 (0.38")

Dimensions:	width	length	height	depth
inches	35.75"	18.5"	4.0"	4.0"
mm	908.05	469.9	101.6	101.6

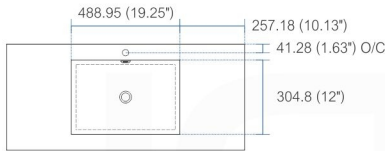

product code  
BSL40SINK

Thickness: 9.53 (0.38")

Dimensions:	width	length	height	depth
inches	39.5"	18.5"	4.0"	4.0"
mm	1003.3	469.9	101.6	101.6

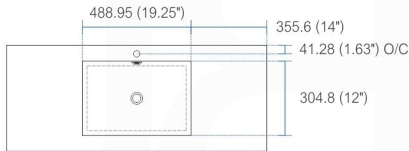

product code  
BSL48SINK

Thickness: 9.53 (0.38")

Dimensions:	width	length	height	depth
inches	47.25"	18.5"	4.0"	4.0"
mm	1200.15	469.9	101.6	101.6

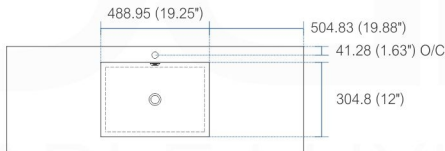

product code  
BSL60SSINK

Thickness: 9.53 (0.38")

Dimensions:	width	length	height	depth
inches	59"	18.5"	4.0"	4.0"
mm	1498.6	469.9	101.6	101.6

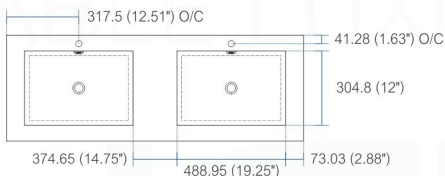

product code  
BSL60DSINK

Thickness: 9.53 (0.38")

Dimensions:	width	length	height	depth
inches	59"	18.5"	4.0"	3.75"
mm	1498.6	469.9	101.6	95.25

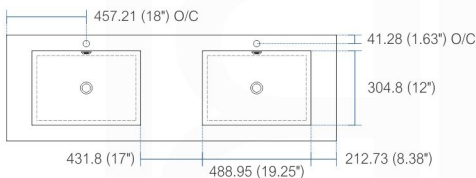

product code  
BSL72SINK

Thickness: 9.53 (0.38")

Dimensions:	width	length	height	depth
inches	71.63"	18.5"	4.0"	4.0"
mm	1819.28	469.9	101.6	101.6

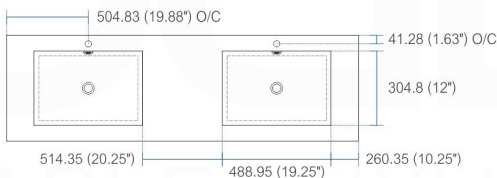

product code  
BSL80SINK

Thickness: 9.53 (0.38")

Dimensions:	width	length	height	depth
inches	79"	18.5"	4.0"	4.0"
mm	2006.6	469.9	101.6	101.6

## Vanity cabinet | removing+adjusting drawers

### To remove the drawer/s

- \* Extend the drawer
- \* Look for the release levers under the drawer, on the sliding bar
- \* To release and remove drawer, simultaneously push the drawer release levers upwards (both sides at the same time) and slide/lift the drawer away from the tracks.
- \* Repeat for each drawer

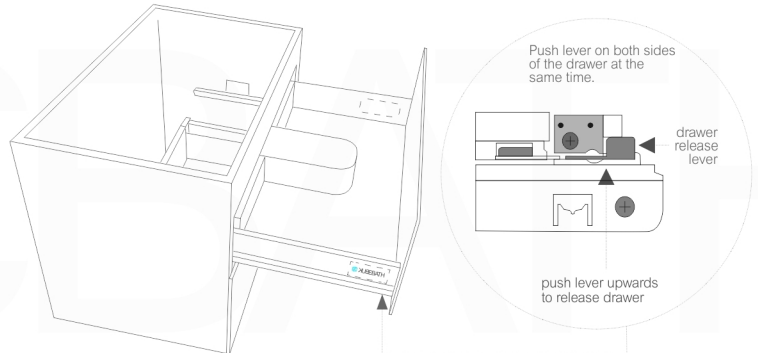

### To replace the drawer/s

- \* Fully extend the drawer runner on each side of the cabinet
- \* Place the drawer onto the runners ensuring that the drawer is levelled on the tracks, and continue to hold in place (otherwise, the drawer will fall).
- \* Keeping the drawer levelled, gently push the drawer along the runners into the cabinet until you hear a click.

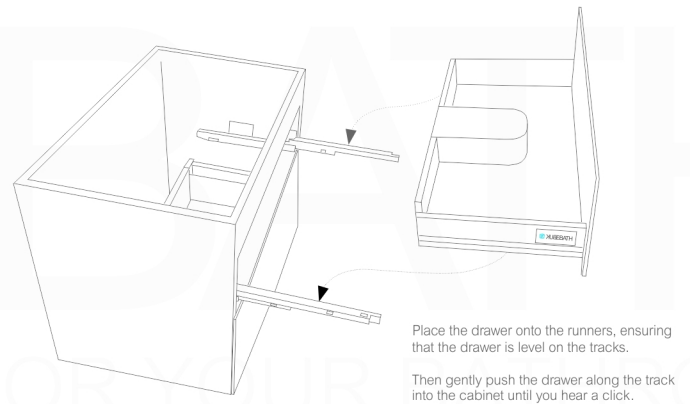

### To adjust the drawer/s

- \* To move the drawer up or down, turn the side screw located under the cover plate on each side of the drawer.

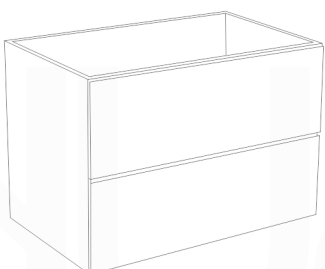
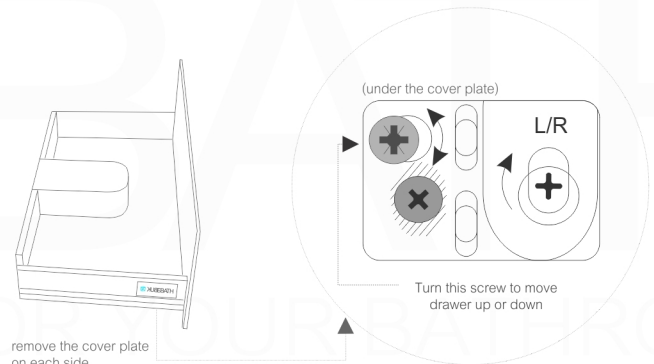

These instructions show a vanity cabinet with two drawers. However, the instructions apply to all cabinets and all sizes of the Bliss Vanity Line. The characteristics and drawer mechanisms are the same for all units.

## How to Install a Bliss Wall-Hung Vanity INSTALLATION GUIDE

### Tools Required for Assembly

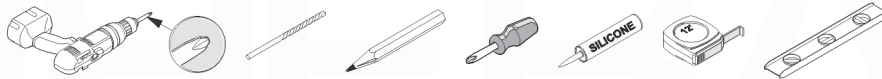

### Wall Preparation

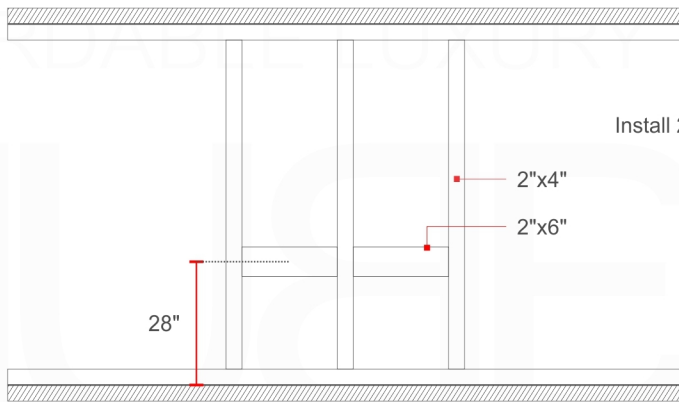

Install 2"x 6" lumber between the wall studs. Desired height: 28".

### Vanity Installation

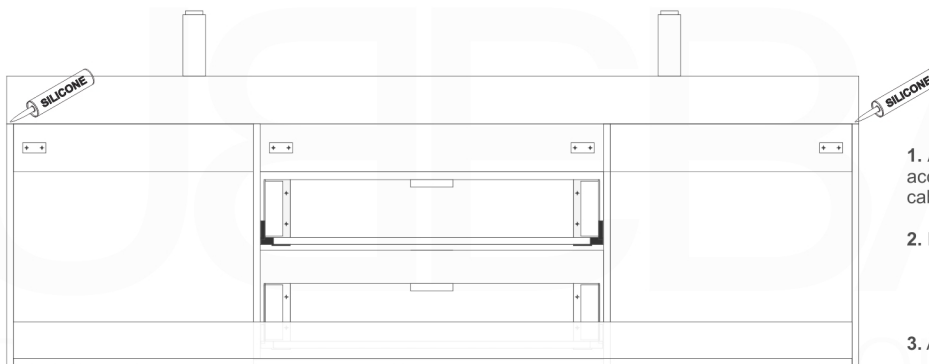

1. Align and level mounting Brackets according to horizontally reinforcement lumber and desired cabinet height.
2. Mount Vanity on to the wall brackets.
3. Add a dap of silicone to the corners of the Cabinet.
4. Gently position and align Counter top Sink onto Vanity.

## Pop-Up / P-trap Installation Instructions INSTALLATION GUIDE

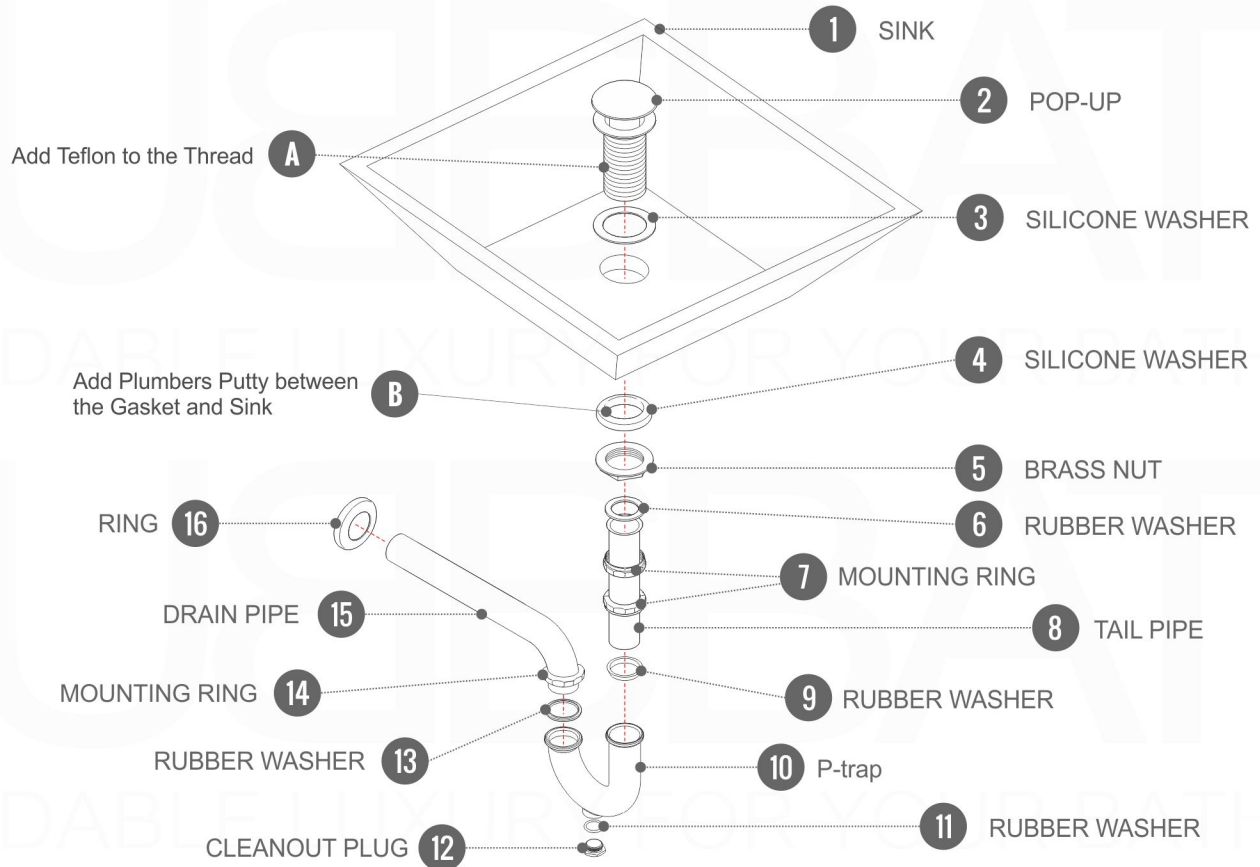

FOR SINKS WITHOUT OVERFLOW  
#SKU: P101N / P102N

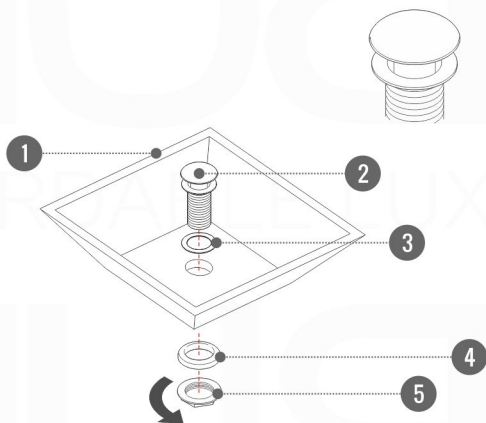

FOR SINKS WITHOUT OVERFLOW  
#SKU: P101 / P102

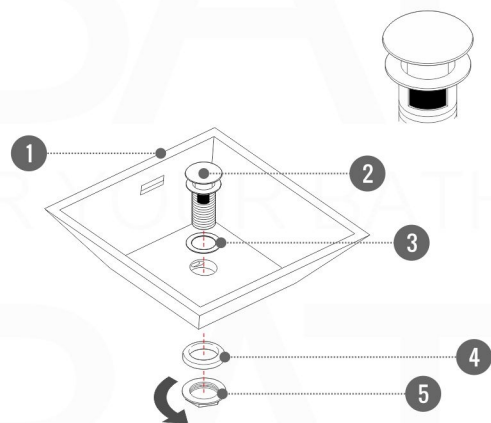

OR