

# Ancerre

DESIGNS

VTS-AUDREY-48

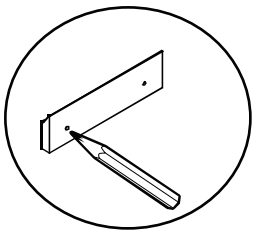

A

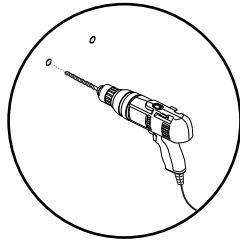

B

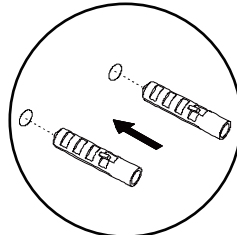

C

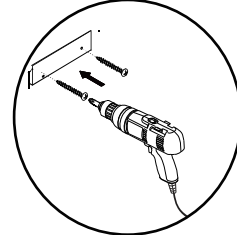

D

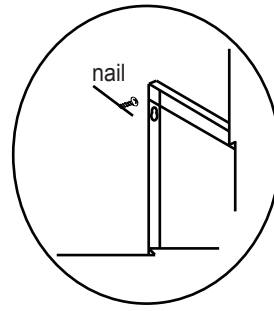

E

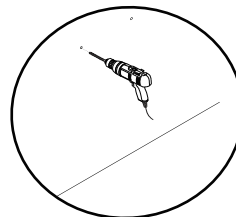

F

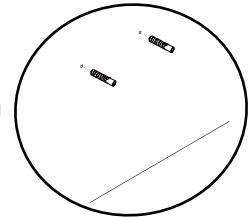

G\*

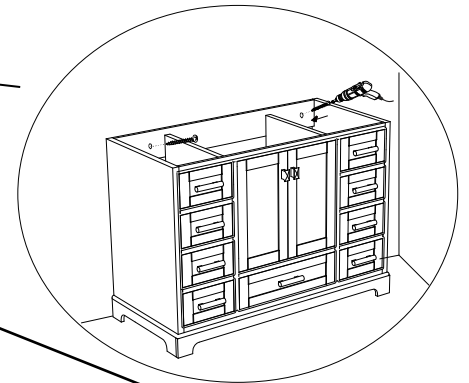

H

Adjustable leg leveler.  
Adjust for level.

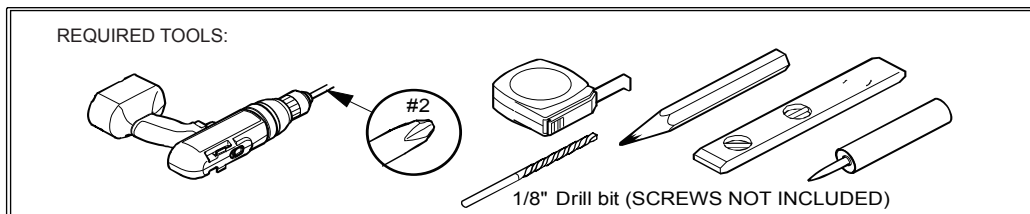

\*SECURE SCREW TO STUDS WHEN POSSIBLE

# Ancerre

DESIGNS

VTS-AUDREY-60

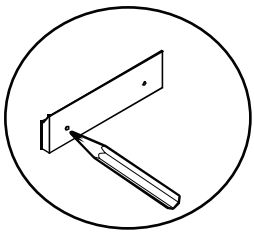

A

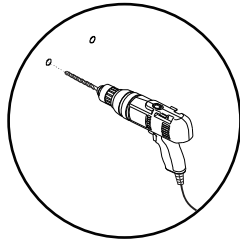

B

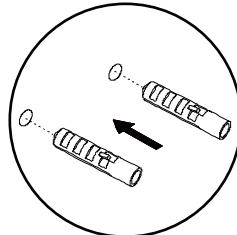

C

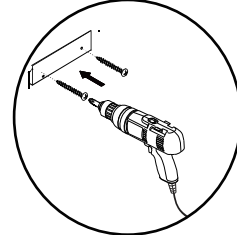

D

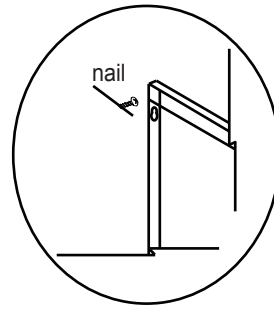
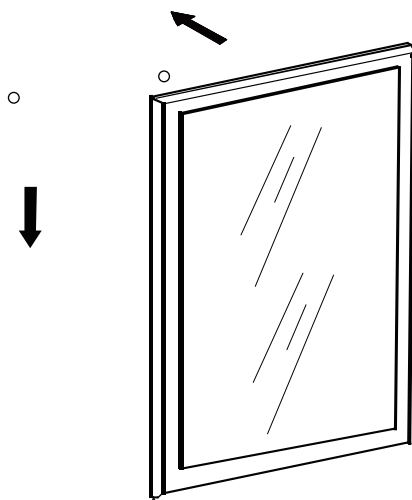

E

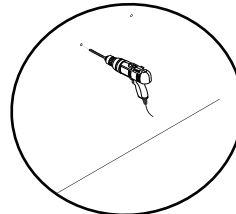

F

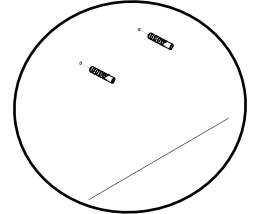

G\*

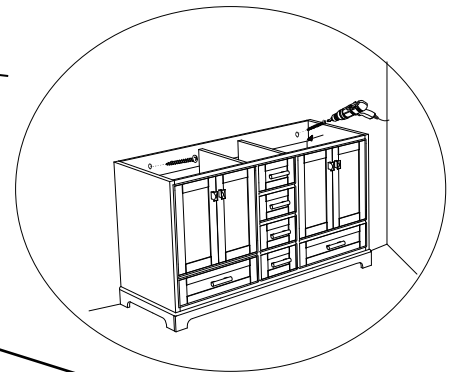

H

 Adjustable leg leveler.  
Adjust for level.

REQUIRED TOOLS:

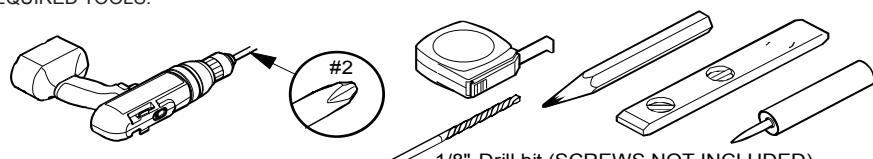

1/8" Drill bit (SCREWS NOT INCLUDED)

\*SECURE SCREW TO STUDS WHEN POSSIBLE

# Ancerre

D E S I G N S

VTS-AUDREY-72

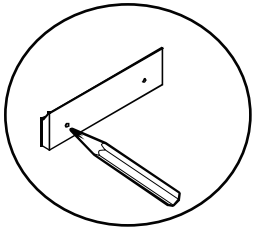

A

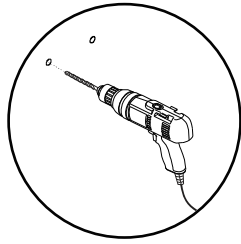

B

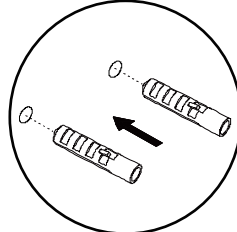

C

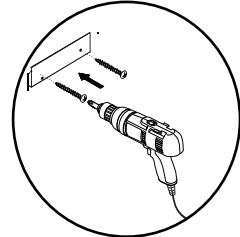

D

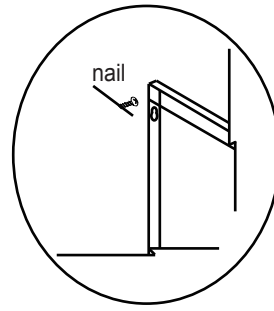
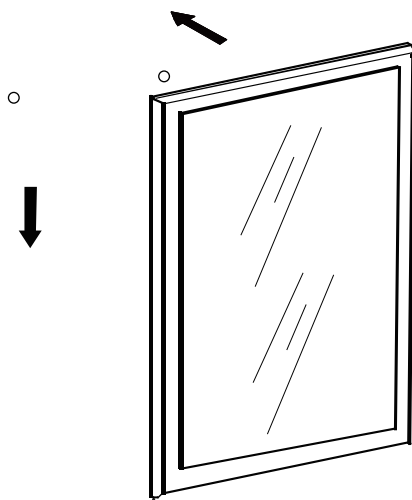

E

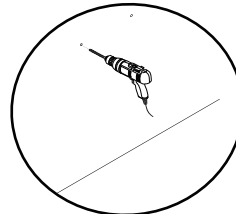

F

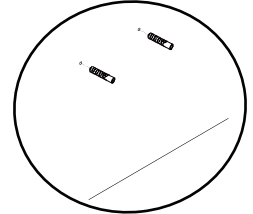

G\*

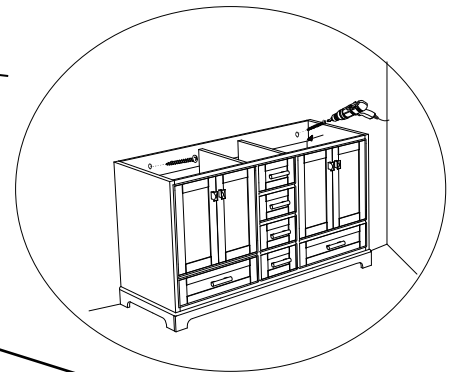
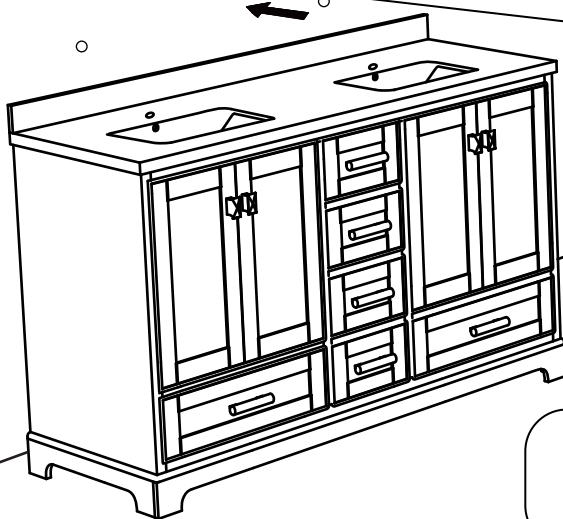

H

Adjustable leg leveler.  
Adjust for level.

REQUIRED TOOLS:

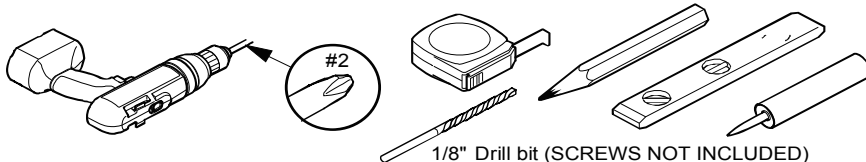

1/8" Drill bit (SCREWS NOT INCLUDED)

\*SECURE SCREW TO STUDS WHEN POSSIBLE