

CISCO STAINLESS STEEL VANITY

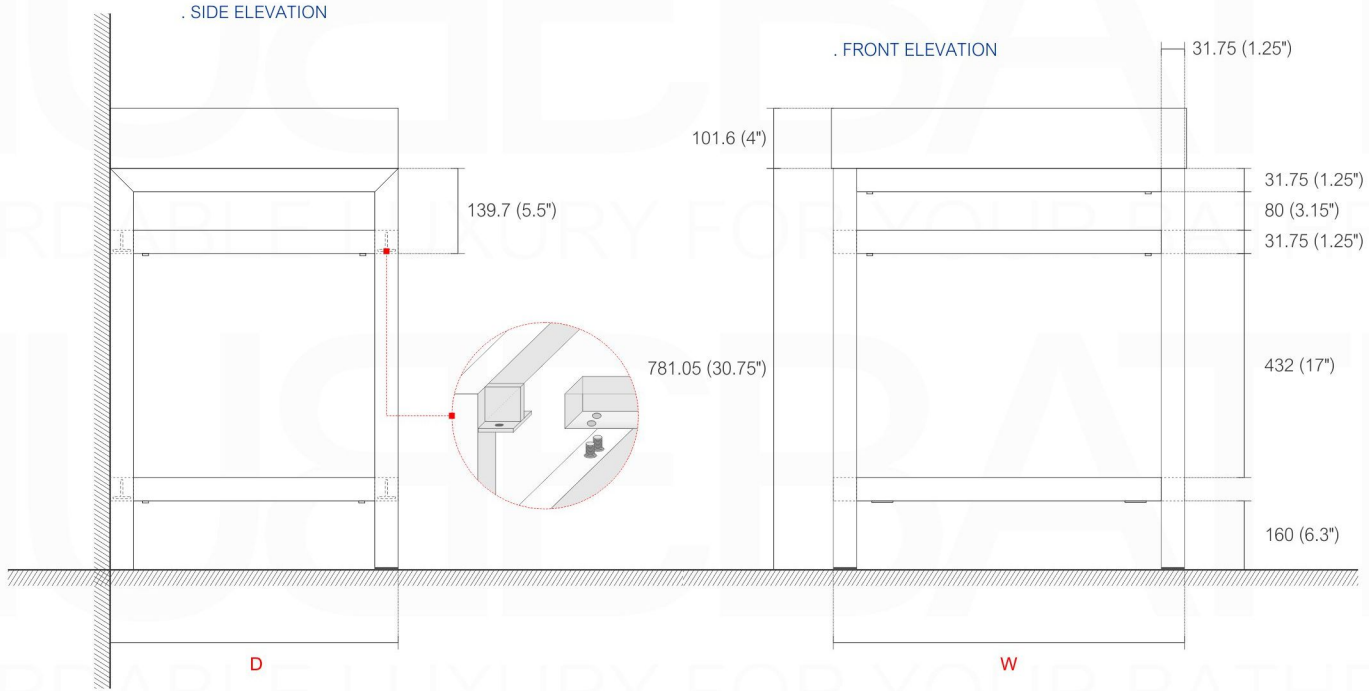

SKU	Dimensions inches:			Dimensions mm:			Sink
	width	depth	height	width	depth	height	SKU
AC 16	16	16	30.75	406.4	406.4	781.05	BSL16
AC 24	23.5	18.5	30.75	597	469.9	781.05	BSL24
AC 30	29.25	18.5	30.75	743	469.9	781.05	BSL30
AC 36	35.5	18.5	30.75	902	469.9	781.05	BSL36
AC 40	39.25	18.5	30.75	997	469.9	781.05	BSL40
AC 48	47	18.5	30.75	1194	469.9	781.05	BSL48
AC 60S	58.75	18.5	30.75	1492	469.9	781.05	BSL60S
AC 60D	58.75	18.5	30.75	1492	469.9	781.05	BSL60D

NOTE: DIMENSIONS AND TECHNICAL DETAILS ARE SUBJECT TO CHANGE WITHOUT NOTICE

CISCO AC16

Sink: BSL16SINK

Dimensions:	width	depth	height
inches	16"	16"	34.875"
mm	406	406	886

NOTE: DIMENSIONS AND TECHNICAL DETAILS ARE SUBJECT TO CHANGE WITHOUT NOTICE

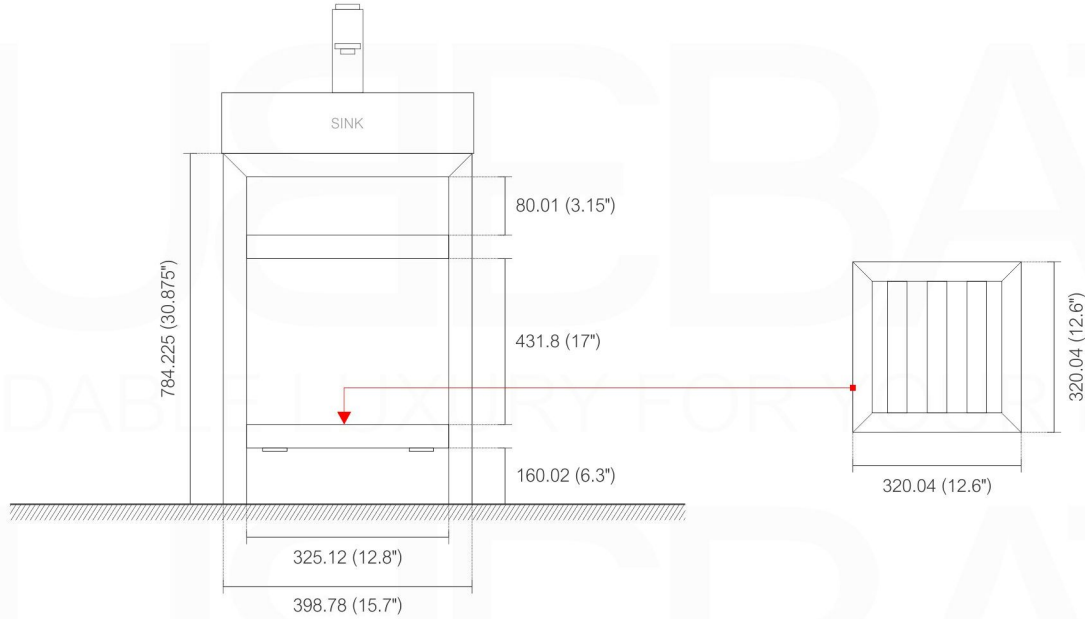

Vanity Installation

1. Remove all the parts from the box and assemble the Console.
2. Add a dap of silicone to the corners of the Console.
3. Gently position and align Counter top Sink onto Vanity.

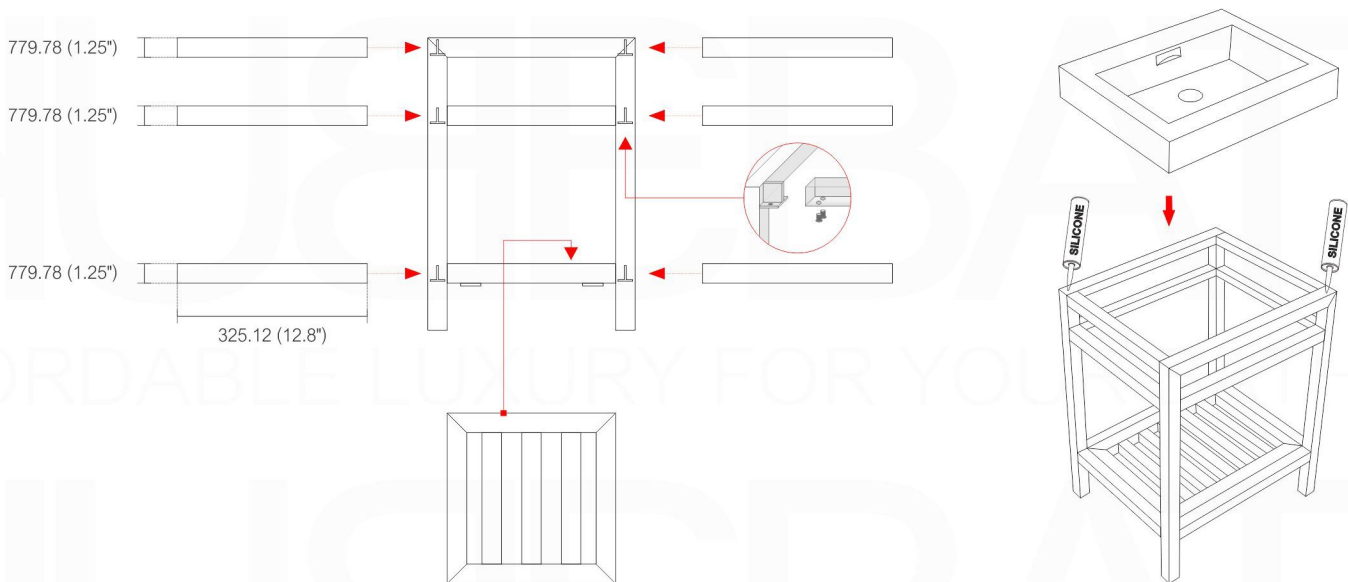

NOTE: DIMENSIONS AND TECHNICAL DETAILS ARE SUBJECT TO CHANGE WITHOUT NOTICE

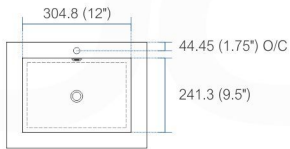

product code
BSL16SINK

Thickness: 9.53 (0.38")

Dimensions:	width	length	height	depth
inches	16.0"	16.0"	4.0"	3.38"
mm	406.4	406.4	101.6	85.73

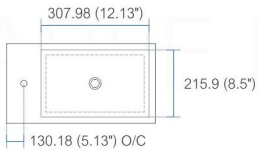

product code
BSL18SINK

Thickness: 9.53 (0.38")

Dimensions:	width	length	height	depth
inches	18.0"	10.25"	4.0"	3.38"
mm	457.2	257.18	101.6	85.73

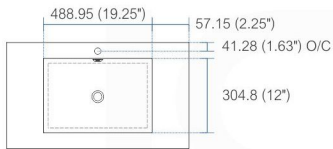

product code
BSL24SINK

Thickness: 9.53 (0.38")

Dimensions:	width	length	height	depth
inches	23.63"	18.5"	4.0"	4.0"
mm	600.08	469.9	101.6	101.6

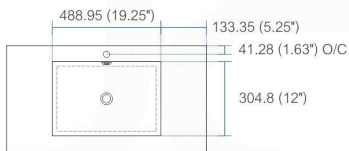

product code
BSL30SINK

Thickness: 9.53 (0.38")

Dimensions:	width	length	height	depth
inches	29.5"	18.5"	4.0"	4.0"
mm	749.3	469.9	101.6	101.6

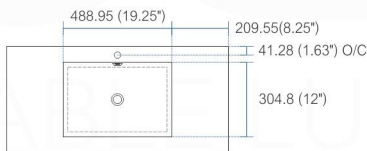

product code
BSL36SINK

Thickness: 9.53 (0.38")

Dimensions:	width	length	height	depth
inches	35.75"	18.5"	4.0"	4.0"
mm	908.05	469.9	101.6	101.6

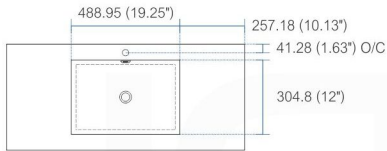

product code
BSL40SINK

Thickness: 9.53 (0.38")

Dimensions:	width	length	height	depth
inches	39.5"	18.5"	4.0"	4.0"
mm	1003.3	469.9	101.6	101.6

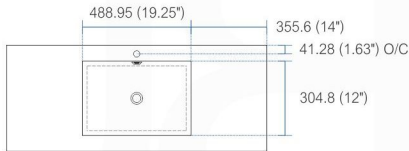

product code
BSL48SINK

Thickness: 9.53 (0.38")

Dimensions:	width	length	height	depth
inches	47.25"	18.5"	4.0"	4.0"
mm	1200.15	469.9	101.6	101.6

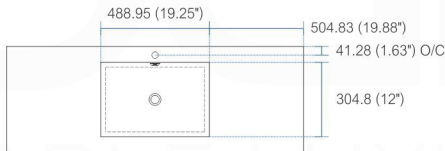

product code
BSL60SSINK

Thickness: 9.53 (0.38")

Dimensions:	width	length	height	depth
inches	59"	18.5"	4.0"	4.0"
mm	1498.6	469.9	101.6	101.6

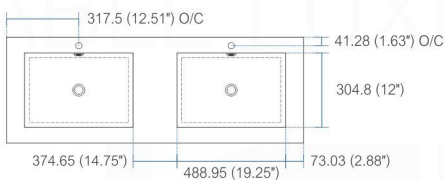

product code
BSL60DSINK

Thickness: 9.53 (0.38")

Dimensions:	width	length	height	depth
inches	59"	18.5"	4.0"	3.75"
mm	1498.6	469.9	101.6	95.25

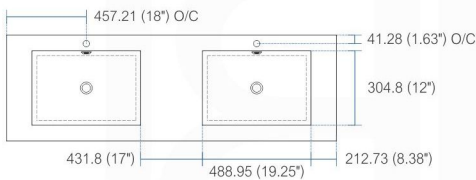

product code
BSL72SINK

Thickness: 9.53 (0.38")

Dimensions:	width	length	height	depth
inches	71.63"	18.5"	4.0"	4.0"
mm	1819.28	469.9	101.6	101.6

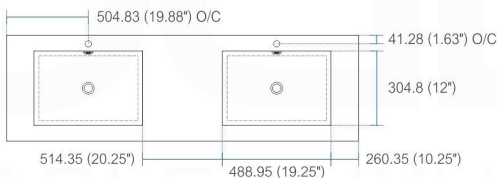

product code
BSL80SINK

Thickness: 9.53 (0.38")

Dimensions:	width	length	height	depth
inches	79"	18.5"	4.0"	4.0"
mm	2006.6	469.9	101.6	101.6

How to Install a Cisco Vanity INSTALLATION GUIDE

Tools Required for Assembly



Vanity Installation



1. Remove the plastic protective film.
2. Install all the Parts of the Cabinet.
3. Add a dap of silicone to the corners of the TOP of the Cabinet.
4. Gently position and align Counter top Sink onto Vanity.

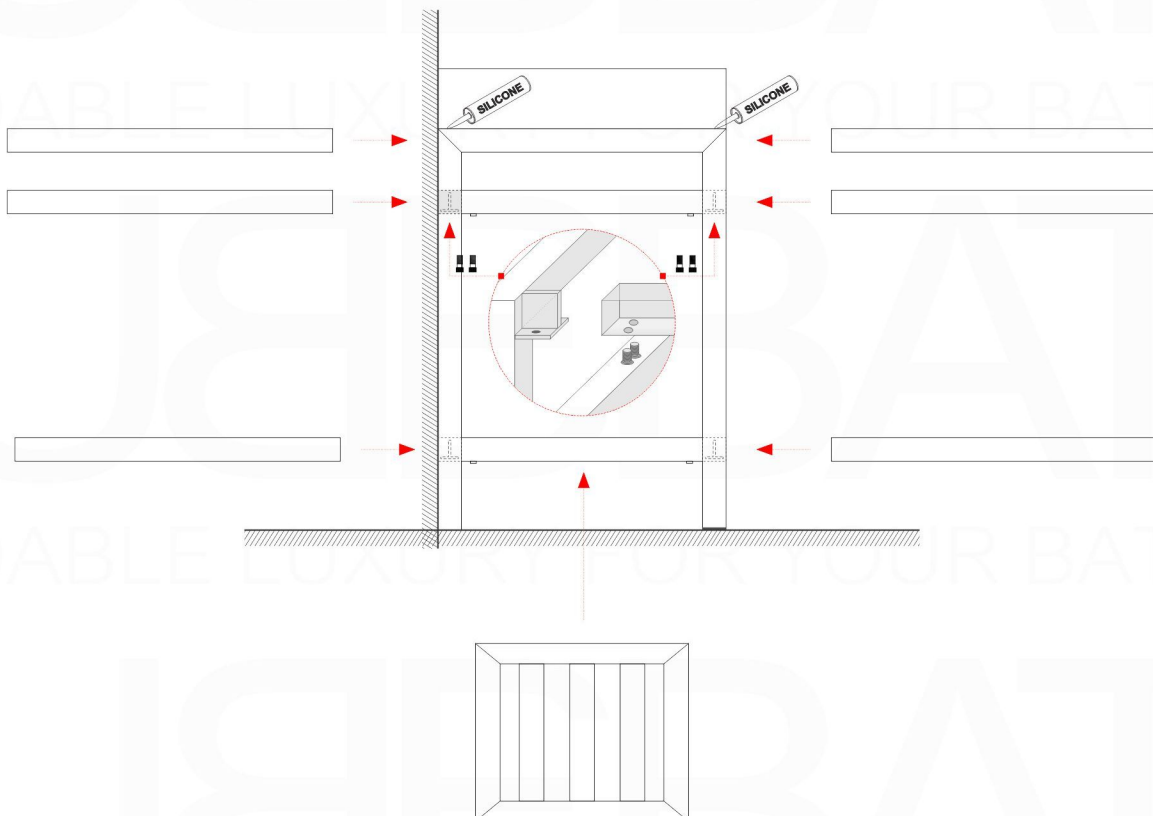

Pop-Up / P-trap Installation Instructions INSTALLATION GUIDE

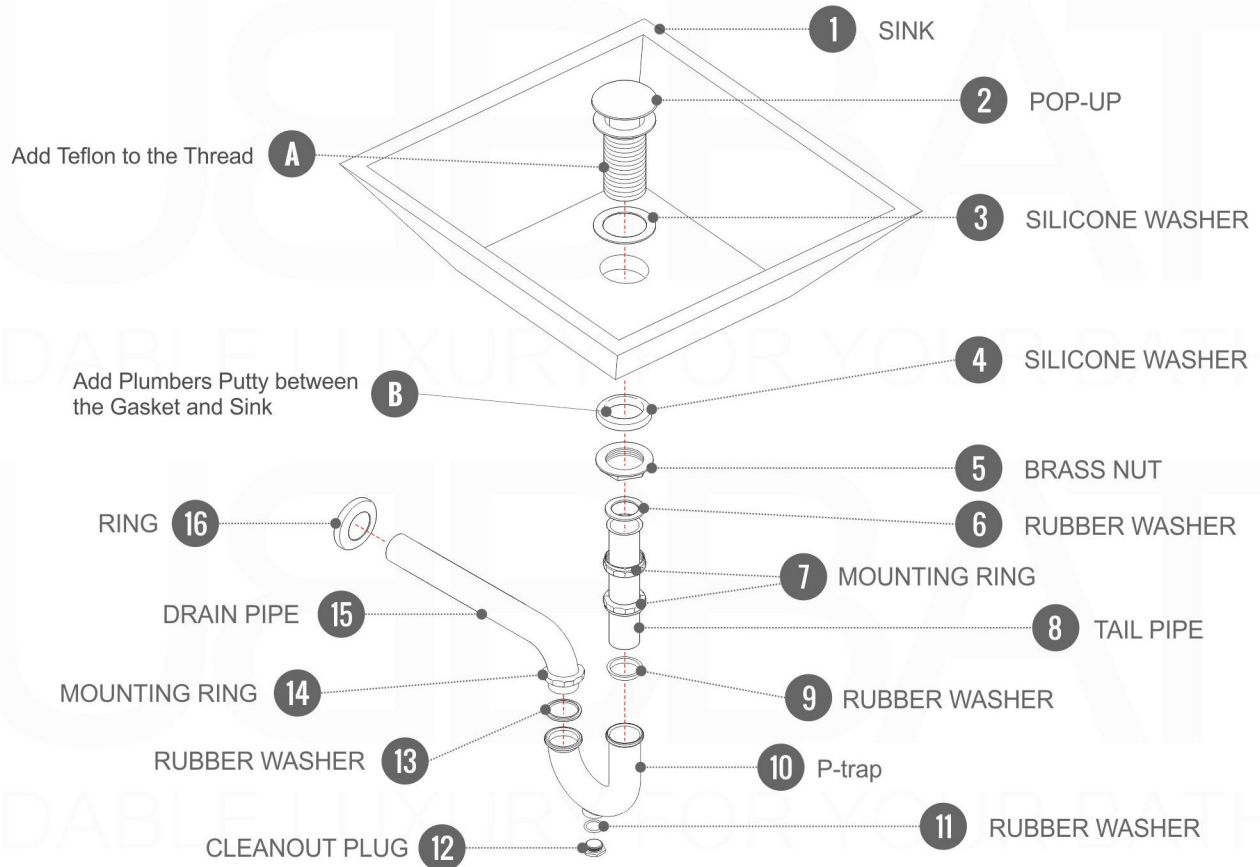

FOR SINKS WITHOUT OVERFLOW
#SKU: P101N / P102N

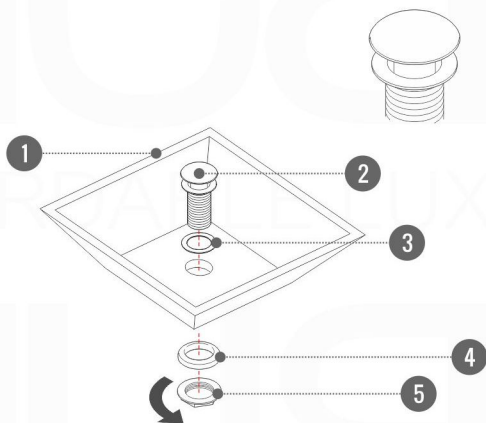

OR

FOR SINKS WITHOUT OVERFLOW
#SKU: P101 / P102

