



WENDELBO

SURFACE

DESIGN BY

365° NORTH



TECHNICAL SPECIFICATIONS

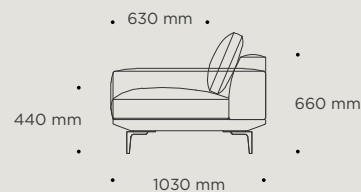

STRUCTURE INTERIOR

Frame made of FSC certified solid wood and MDF, with nozag spring system.

STRUCTURE PADDING

High resilient, variable density, polyurethane foam, with dacron padding.

SEAT CUSHION

High resilient polyurethane foam with 100% down/feather top in downproof cambric divided into channels.

BACK CUSHION

100% down/feather top in downproof cambric divided into channels.

COVER

Removable back and seat cushion cover.

LEGS

Black powder coated aluminum.

MAINTENANCE

We recommend shaking and fluffing-up the cushions regularly to maintain the shape. This should be done after removing the cushions from the structure for improved air circulation. For maintenance of fabric and leather, please contact your retailer.

SURFACE

Module 1
2 seater, narrow arm left

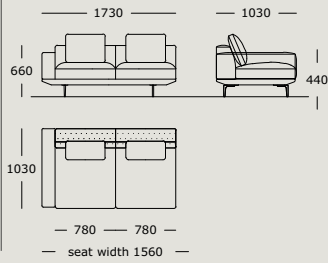

Module 2
2 seater, narrow arm right

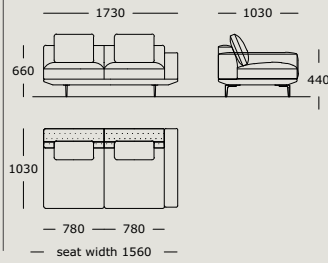

Module 3
2 seater/corner, back left

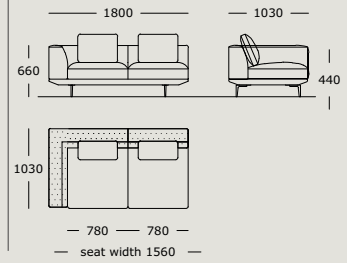

Module 4
2 seater/corner, back right

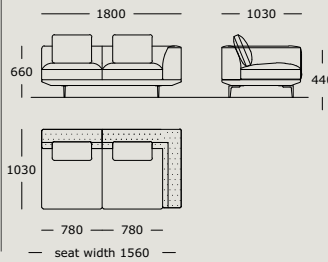

Module 5
Corner

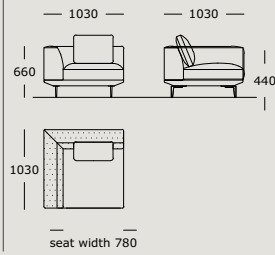

Module 6
Stool

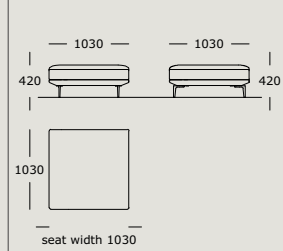

Module 7
Chaise wide arm, wooden tray left

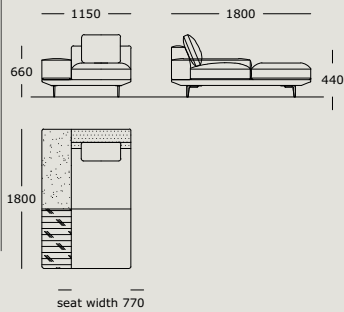

Module 8
Chaise wide arm, wooden tray right

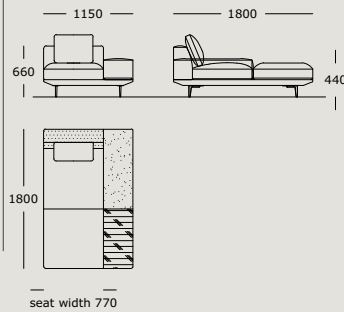

Module 9
2 seater, wide arm left

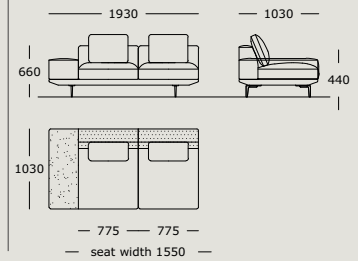

Module 10
2 seater, wide arm right

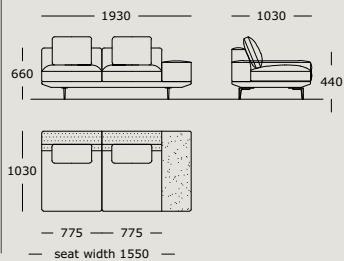

Module 11
2 seater, wooden tray left

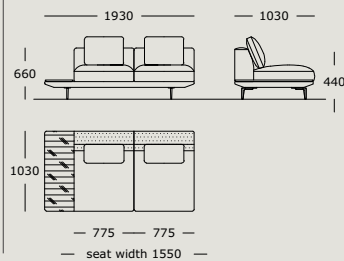

Module 12
2 seater, wooden tray right

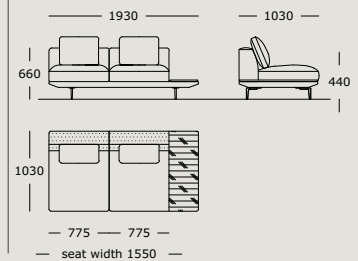

Module 13
1 seater, wide arm left

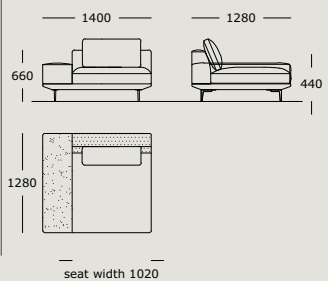

Module 14
1 seater, wide arm right

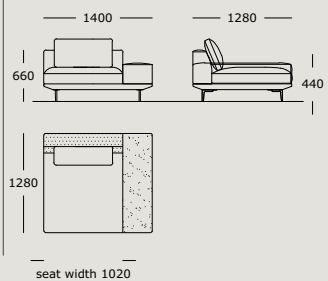

Module 15
1 seater, wooden tray left

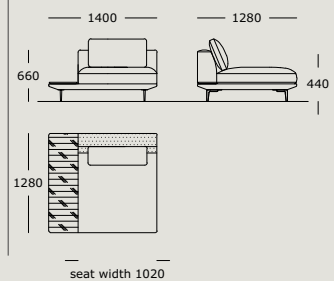

SURFACE

Module 16
1 seater, wooden tray right

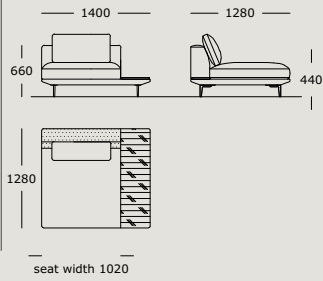

Module 17
Center XL

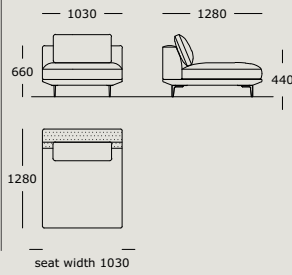

Module 18
2 seater, center

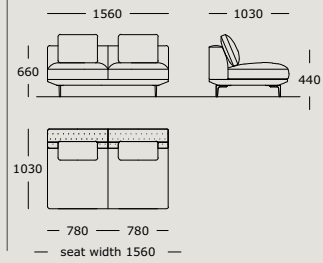

Module 19
Chaise, wide arm left

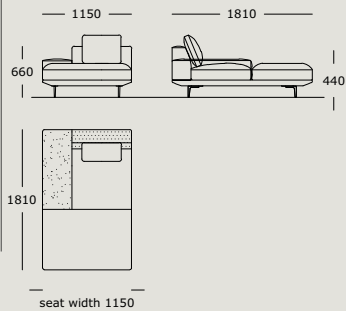

Module 20
Chaise, wide arm right

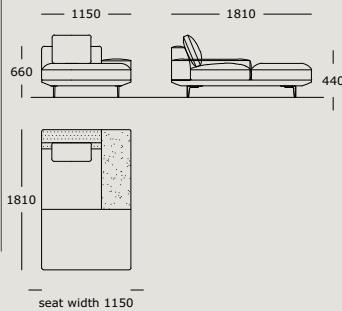

Module 21
Center

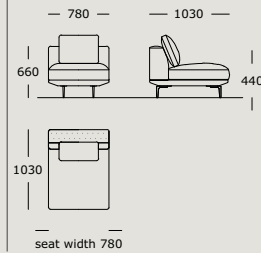

Module 22
1 seater, wooden tray left

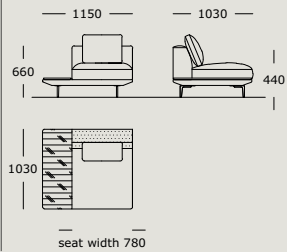

Module 23
1 seater, wooden tray right

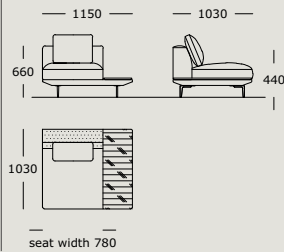

Module 24
1.5 seater, open end left

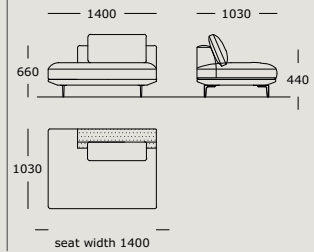

Module 25
1.5 seater, open end right

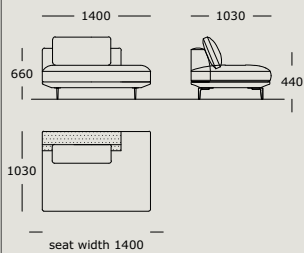

Module 26
2 seater/corner, back right, wooden tray left

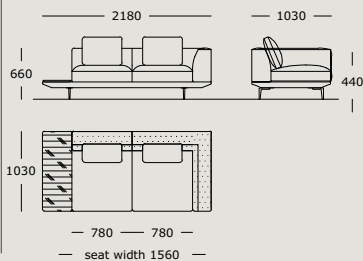

Module 27
2 seater/corner, back left, wooden tray right

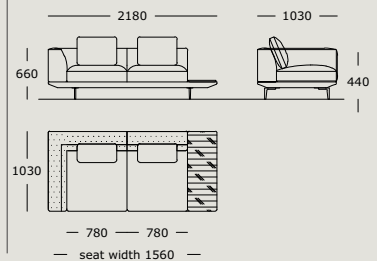

Module 28
2.5 seater, corner, open end left

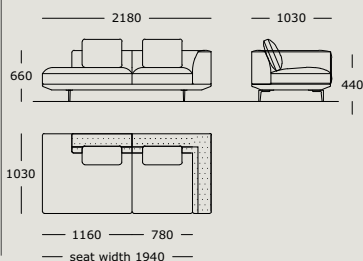

Module 29
2.5 seater, corner, open end right

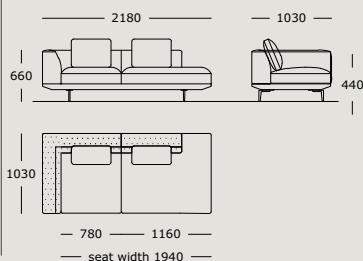

Module 30
1 seater, slim arm left

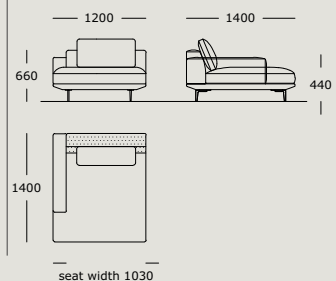

SURFACE

Module 31
1 seater, slim arm right

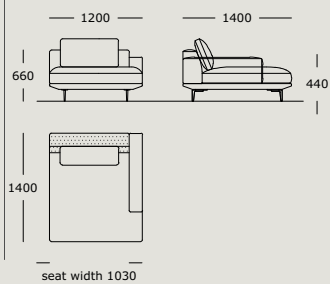

3 seater

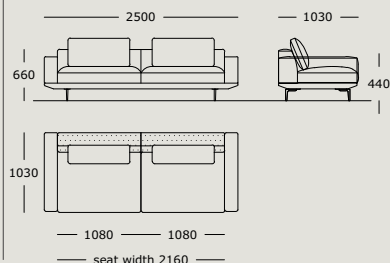

2.5 seater

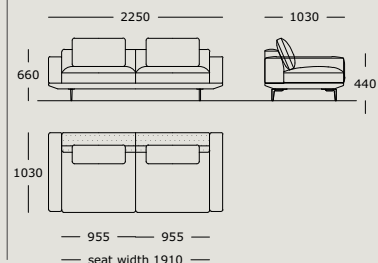

2 seater

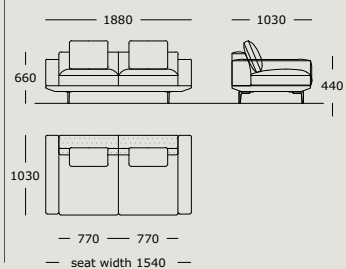

Slim tall arm
H = 560 mm / W = 190 mm



Wooden top
H = 240 mm / W = 360 mm



Low wide arm
H = 470 mm / W = 380 mm



Normal back
H = 660 mm / W = 270 mm