

General Facts



Curt Sofasystem

Curt is probably the simplest and most flexible sofasystem in the world. There is only one modular form, a pouf. If you connect several of these same modules via the patent pending connection system, sofas can be created in every imaginable configuration. Infinite possibilities. And can be changed at any time into any imaginable configuration.

This not only allows unprecedented planning possibilities for a sofa system, but also the possibility of adapting the finished product again and again to the needs of the user.

Design: Malte Grieb und Joa Herrenknecht

Dimensions single module

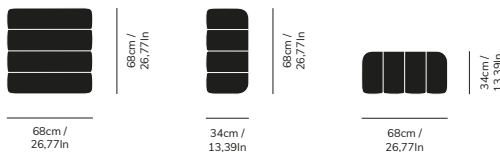

Width: 68 cm/26,77In
 Length: 68 cm/26,77In
 Seat height: 34 cm/13,39In
 Height arm and backrest: 68 cm/26,77In

Fabrics

Jet



Barcelona

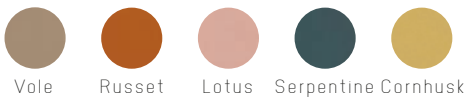

Dama

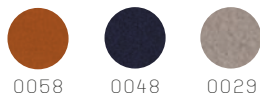

Sera

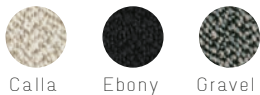

Materials

Inside each Curt module there is not only a stable plywood frame covered with upholstery straps, but also a cold foam padding consisting of three different layers.

- Foam: Cold foam (flame retardant on request) ① ② ⑥ ⑦ ⑧
- Frame: Plywood ③
- Loops and Belts: 80% polyester / 20% polypropylene ④
- Buckle: Aluminium
- Upholstery Straps: Polypoprylen ⑤
- Cover: Fabric, cold foam ⑨

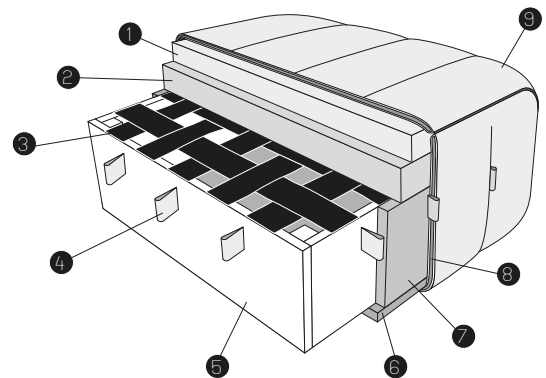

Contract: All materials can be equipped for use in hotels or public buildings on request.

AMBIVALENZ

Sample sets

Set of 1

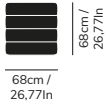

Set of 3

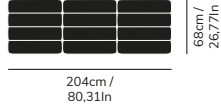

Set of 4

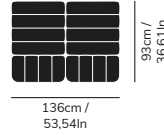

Set of 6

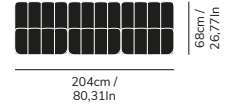
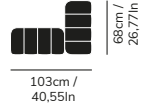
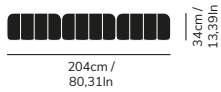
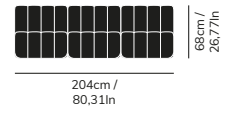
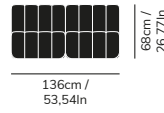
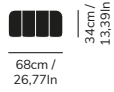
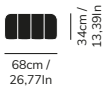
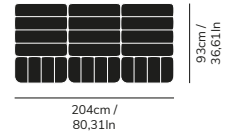

Set of 7

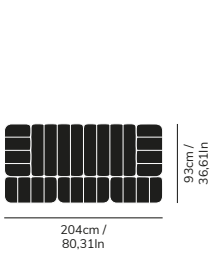

Set of 9

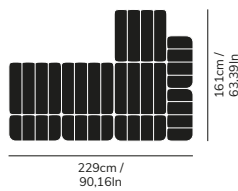

Set of 12

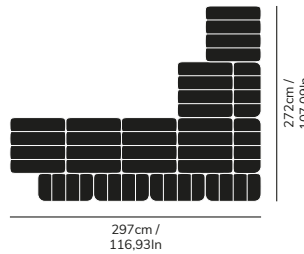

Set of 15

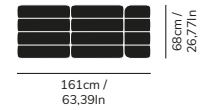
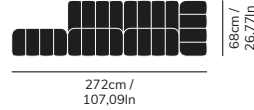
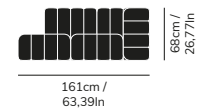
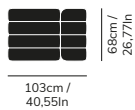
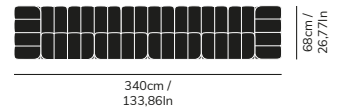
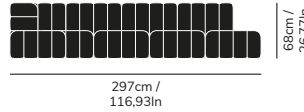
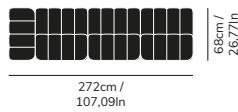
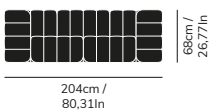
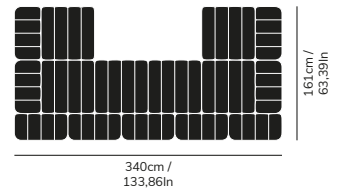

Configurations

Set of 3

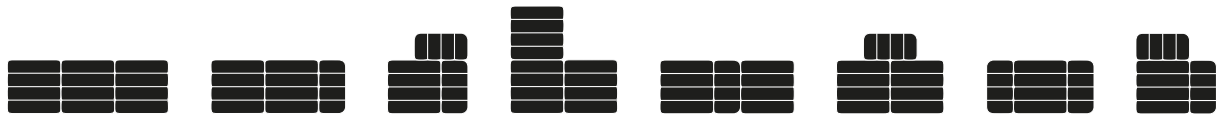

Set of 4



Set of 6

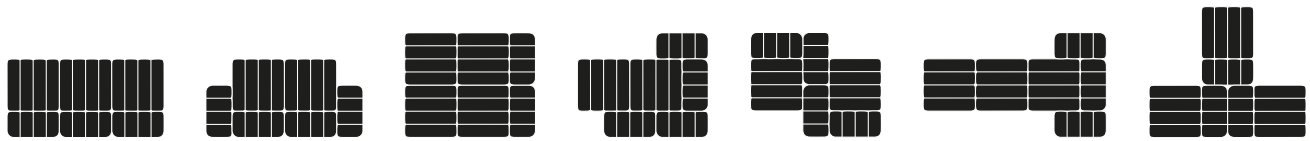

Set of 7

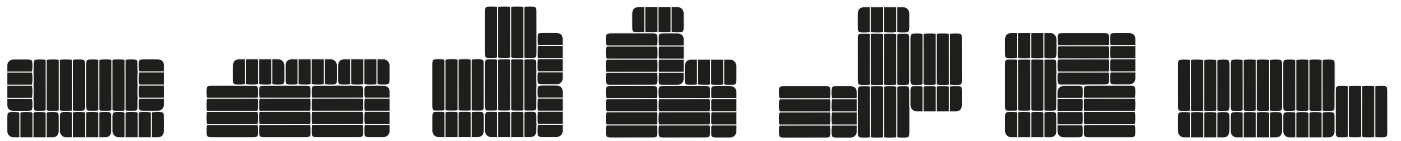

Set of 9

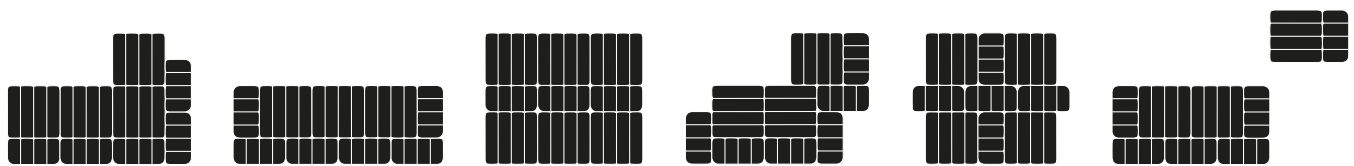

Set of 12

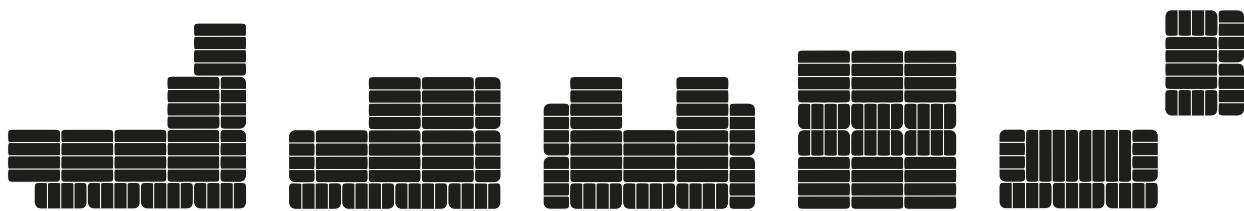

Set of 15

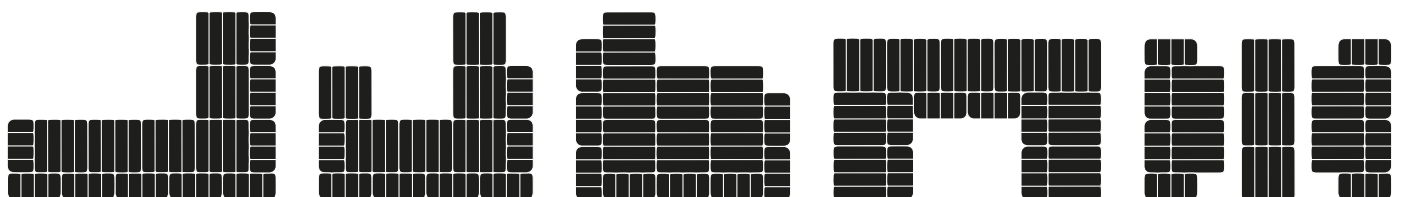

Fabrics - Details

Jet - 100% Trevira CS/Polyester



9607

6098

9605



9860

9803

9110

Martindale
Pilling
Light fastness 6

> 65.000 turns
5



Fire retardancy
DIN 4102 Class B1
EN 1021-1 & 2
BS Crib 5
California TB117
And many more

Barcelona - Samt/Velvet 100% Polyester



Vole

Russet

Lotus



Serpentine

Cornhusk

Martindale
Pilling
Light fastness 6

> 100.000 turns
4-5



Fire retardancy
NFPA260
CAL117
(For Contract and UK we can alternatively use the Fabric Pico)

Dama - 70% Recycled Wolle/Wool - 20% PL - 5% PA - 5% PC



0058

0048

0029

Martindale
Pilling
Light fastness 5

> 60.000 turns
4-5



Fire retardancy
EN 1021-1 & 2
California TB117
BS Crib 5 (on request)

Sera - 94% Wolle/Wool 6% PA



Calla

Ebony

Gravel

Martindale
Pilling
Light fastness

> 122.000 turns
4-5
5-8



Fire retardancy
DIN 4102-1 B2
EN 1021-1 & 2
BS Crib 5
California TB117
And many more

The System

The Module

Hard to believe but true. This infinite variety is created by only one single modular form. A cuboid with a square base whose height is half the length of its sides. In addition 16 hidden connection loops, only visible when needed. So simple, so infinite.

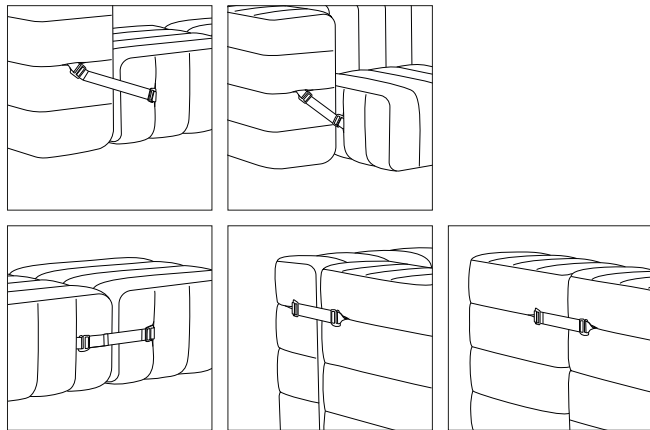
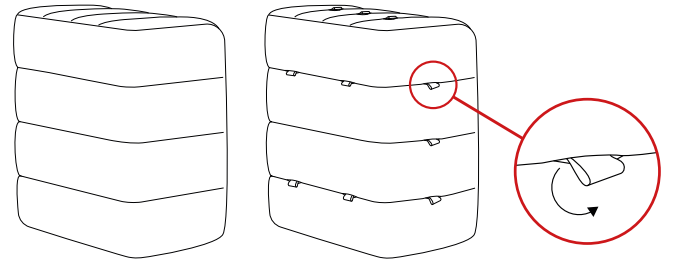

The Connection

This is not a connection for eternity. Short-term bonds are common practice, now even for sofas. If you had enough of one, the hook is easily released and ready for a new configuration. An adjustable strap with two simple hooks. This is Curts belt. There are three attachment loops on each side of the module and four on the back for hooking in. That's how fast Curt bonds again and again and again.

The Cover

The cover of Curt is Also rather unusual. Two rectangles, formed into a U, which can be joined and divided with a full length zipper. Removable, exchangeable, dividable, combinable and easy to clean. One red and one blue module become two red blue modules.

