Manual

Vibratory Sieve Shaker AS 200 digit cA



 **Eijkelkamp**
Meet the difference

Nijverheidsstraat 9,
6987 EN Giesbeek, The Netherlands
T +31 313 880 200
E info@eijkelkamp.com
I royaleijkelkamp.com



Translation

Table of Contents

1	Notes on the Manual	6
1.1	Disclaimer	6
1.2	Copyright.....	6
1.3	Explanations of the Safety Instructions	7
1.4	General Safety Instructions	8
1.5	Repairs.....	9
2	Confirmation Form for the Managing Operator	11
3	Technical Data	12
3.1	Degree of Protection.....	12
3.2	Emissions.....	12
3.3	Electromagnetic Compatibility (EMC).....	13
3.4	Rated Power	13
3.5	Dimensions and Weight.....	13
3.6	Required Floor Space.....	13
3.7	Receptacle Volume.....	14
3.8	Feed Grain Size	14
3.9	Payload.....	15
3.10	Suitable Sieve Diameters	15
4	Packaging, Transport and Installation	16
4.1	Packaging	16
4.2	Transport.....	16
4.3	Temperature Fluctuations and Condensation	16
4.4	Conditions for the Installation Site	17
4.5	Electrical Connection	18
4.6	Type Plate Description.....	18
4.7	Removing the Transportation Lock.....	19
5	First Commissioning	21
5.1	Sieve Clamping Unit "economy" and "standard"	21
5.2	Sieve Clamping Unit "comfort".....	22
6	Operating the Device	25
6.1	Use of the Device for the Intended Purpose.....	25
6.2	Views of the Instrument	27
6.2.1	Front.....	27
6.2.2	Back	29
6.3	Switching On / Off.....	29
6.4	Selection of the Test Sieves	30
6.5	Performing a Sieving	30
7	Controlling the Device	31
7.1	Operating Controls, Displays and Functions	31
7.2	Start Process	31
7.3	Stop Process	32
7.4	Pause Process.....	32
7.5	Amplitude.....	32
7.5.1	Amplitudes in Dependence on the Load.....	33
7.6	Time	34

7.7	Optimisation of Time and Amplitude.....	34
7.8	Interval.....	35
7.9	Signal Tone.....	36
7.10	Operating Hours.....	36
7.11	Software Version.....	36
8	Wet Sieving.....	37
9	Error Messages and Information Notes.....	40
9.1	Error Messages.....	40
9.2	Information Notes.....	40
10	Return for Service and Maintenance.....	41
11	Cleaning, Wear and Maintenance.....	42
11.1	Cleaning.....	42
11.1.1	Cleaning of Test Sieves.....	42
11.1.1.1	Cleaning of Test Sieves with Mesh Sizes > 500 µm.....	42
11.1.1.2	Cleaning of Test Sieves with Mesh Sizes < 500 µm.....	43
11.1.1.3	Drying of Test Sieves.....	43
11.2	Wear.....	43
11.3	Maintenance.....	43
11.3.1	Replacing the Fuses.....	44
12	Accessories.....	45
12.1	Test Sieves.....	45
12.1.1	Certificate.....	46
12.1.2	Calibration Service.....	46
12.2	Sieving Aids.....	46
12.3	Add-on Weight.....	47
13	Disposal.....	48
14	Index.....	49
	CE Declaration.....	following page

1 Notes on the Manual

Dear user,

please read the following manual referring to this device carefully before starting any installation, commissioning and operation.

This manual is a technical guide on how to operate the device safely and it contains all the information required for the areas specified in the table of contents. This technical documentation is a reference and instruction manual. The individual chapters are complete in themselves. Familiarity (of the respective target groups defined according to area) with the relevant chapters is a precondition for the safe and appropriate use of the device.

This manual does not contain any repair instructions. In case of any obscurities or questions with regards to this document or the device, as well as if faults arise or repairs are necessary, please contact your supplier or get in touch with Retsch GmbH directly.

Application-technical information relating to samples to be processed are not or only to a certain extend included. However, more information thereof can be found at the internet page of the respective device on the Retsch GmbH homepage (<http://www.retsch.com>).

Revision status:

This document revision 0002 refers to the manual "Vibratory Sieve Shaker AS 200 digit cA" in compliance with the Directive of Machinery 2006/42/EG.

1.1 Disclaimer

This document has been prepared with due care. Technical and software based modifications are reserved. No liability is assumed for data loss, personnel injury or damage to the device which results from the failure to observe the instructions and/or warnings in this document.

1.2 Copyright

This document or parts of it or its content may not be reproduced, distributed, edited or copied in any form without prior written permission of Retsch GmbH. Damage claims shall be asserted in the case of infringements.

1.3 Explanations of the Safety Instructions

In this document the following **signs and symbols** are being used:

①	Reference to a recommendation and/or an important information
→	Reference to a chapter, table or figure
⇒	Action instruction
Name	Menu function
[Name]	Software button
<Name>	Software checkbox

In this document the following **safety instructions** warn of possible dangers and damages:



D1.0000

Type of danger / personal injury

Source of danger

- Possible consequences if the dangers are not observed.
 - **Instructions and information on how the dangers are to be avoided.**
-

Life-threatening personal injuries may result from disrespecting the safety instruction for danger. There exists a very high risk of hazard of life or permanent injury to personnel.

Additionally, in continuous text or action instructions the signal word  is used.



W1.0000

Type of danger / personal injury

Source of danger

- Possible consequences if the dangers are not observed.
 - **Instructions and information on how the dangers are to be avoided.**
-

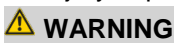
Serious personal injuries may result from disrespecting the warning notice. There exists an elevated risk of an accident or severe injury to personnel. Additionally, in continuous text or action instructions the signal word  is used.



C1.0000

Type of danger / personal injury

Source of danger

- Possible consequences if the dangers are not observed.
 - **Instructions and information on how the dangers are to be avoided.**
-

Moderate or mild personal injuries may result from disrespecting the safety instruction for caution. There exists a medium or low risk of an accident or injury to personnel. Additionally, in continuous text or action instructions the signal word  **CAUTION** is used.

NOTICE

N1.0000

Type of property damage

Source of property damage

- Possible consequences if the notices are not observed.
- **Instructions and information on how the property damages are to be avoided.**

Property damages may result from disrespecting the notice. However, there exists no risk of an injury to personnel. Additionally, in continuous text or action instructions the signal word *NOTICE* is used.

1.4 General Safety Instructions



CAUTION

C2.0002

Read the manual

Non-observance of the operating instructions

- The non-observance of this manual can result in personal injuries.
- **Read the manual before using the device.**
- **The adjacent symbol indicates the necessity of knowing the contents of this manual.**



Target group:

All persons concerned with the device in any form.

This device is a modern, high performance product from Retsch GmbH and complies with the state of the art. Operational safety is given if the device is handled for the intended purpose and attention is given to this technical documentation.

Safety manager:

The managing operator himself must ensure that the people entrusted with working on the device...

- have noted and understood all the regulations regarding safety,
- are familiar before starting work with all the operating instructions and specifications for the target group relevant to their work,
- have unrestricted and free access to the technical documentation for this device,

- are familiarising new personnel with the safe handling of the device and its use for its intended purpose before starting work either by verbal instructions from a competent person and/or by means of this technical documentation.

 **CAUTION** Improper operation can result in personal injuries and material damage. The managing operator himself is responsible for his own safety and that of his employees. The managing operator himself is responsible that no unauthorised person has access to the machine.

 **CAUTION**

C3.0015

Changes to the device

Improper modifications

- Changes to the device can lead to personal injuries.
- **Do not make any modification to the device.**
- **Use spare parts and accessories that have been approved by Retsch GmbH exclusively.**

NOTICE

N2.0012

Changes to the device

Improper modifications

- The conformity declared by Retsch GmbH with the European Directives will lose its validity.
- Any warranty claims will be terminated.
- **Do not make any modification to the device.**
- **Use spare parts and accessories that have been approved by Retsch GmbH exclusively.**

1.5 Repairs

This manual does not contain any repair instructions. For safety reasons, repairs may only be carried out by Retsch GmbH or an authorised representative or by qualified service technicians.

In case of repair, please inform...

- ...the Retsch GmbH representative in your country,
- ...the supplier, or
- ...Retsch GmbH directly.

Service address:



Nijverheidsstraat 9,
6987 EN Giesbeek, The Netherlands
T +31 313 880 200
E info@eijkelkamp.com
I royaleijkelkamp.com

2 Confirmation Form for the Managing Operator

This manual contains essential instructions for operating and maintaining the device which must be strictly observed. It is essential that they be read by the operator and by the qualified staff responsible for the device before the device is commissioned. This manual must be available and accessible at the place of use at all times.

The user of the device herewith confirms to the managing operator (owner) that he has received sufficient instructions about the operation and maintenance of the system. The user has received the manual, has read and taken note of its contents and consequently has all the information required for safe operation and is sufficiently familiar with the device.

The managing operator should for legal protection have the user confirm the instruction about the operation of the device.

I have read and taken note of the contents of all chapters in this manual as well as all safety instructions and warnings.

User

Surname, first name (block letters)

Position in the company

Place, date and signature

Managing operator or service technician

Surname, first name (block letters)

Position in the company

Place, date and signature

3 Technical Data

3.1 Degree of Protection

- IP54 (IP20 in the area of the sieve carrier passage)

3.2 Emissions



C4.0011

Possibility of acoustic signals not being heard

Loud sieving noises

- Possible acoustic alarms and voice communication might not be heard.
- **Consider the volume of the sieving noise in relation to other acoustic signals in the work environment. Additional visual signals may be used.**



C5.0077

Hearing damage

A high sound level may be generated depending on the type of material, the number of sieves, the sieving aid used, the amplitude set and the duration of the sieving

- Excessive noise in terms of level and duration can cause impairments or permanent damage to hearing.
- **Ensure suitable noise protection measures are taken or wear ear protection.**



Sound parameters:

The sound parameters are also influenced by the set amplitude, the number of test sieves and the properties of the sample material.

Example 1:

Number of test sieves:	5
Amplitude:	1.5 mm
Feed material:	Quartz sand (< 1 mm)
Sieve clamping unit:	"comfort"

At these operating conditions, the workplace related equivalent continuous sound level $L_{eq} = 51.2 \text{ dB(A)}$.

Example 2:

Number of test sieves:	5
Amplitude:	3 mm

Technical Data

Feed material:	Quartz sand (< 1 mm)
Sieve clamping unit:	"comfort"

At these operating conditions, the workplace related equivalent continuous sound level $L_{eq} = 61.6$ dB(A).

3.3 Electromagnetic Compatibility (EMC)

- EMC class according to EN 50011: A

Strong electromagnetic interference fields, such as high-power radio transmitters, can have an adverse influence on the amplitude control of the AS 200 digit cA. Once the source of the interference is eliminated, the AS 200 digit cA will return to normal operation by itself.

3.4 Rated Power

~ 460 W (VA)

3.5 Dimensions and Weight

- Height without sieve clamping unit: 212 mm
- Height with sieve clamping unit: 842 mm
- Width: 417 mm
- Width with "comfort" clamping unit: 448 mm
- Depth: 384 mm
- Weight without sieve stack, without clamping unit: ~ 35 kg

3.6 Required Floor Space



CAUTION

C6.0047

Falling down of the device

Incorrect positioning or insufficient working space

- Due to its weight, the device can inflict personal injury if it falls down.
- **The device must only be operated on a sufficiently large, strong and stable workplace.**
- **All feet of the device must be positioned securely.**

- Width of the base: 450 mm
- Depth of the base: 450 mm
- No safety clearances required

Location requirements:

The device must be placed on a vibration-free, plane, stable and free surface to avoid transmission of vibrations. A level base ensures the uniform distribution of the sample over the sieve mesh fabric, as well as the stability of the device.

3.7 Receptacle Volume

The maximum receptacle volume (the maximum feed quantity) depends on various factors such as number and aperture size of the test sieves, maximum grain size and width of distribution of the sample material.

Examples for the maximum feed quantity according to DIN 66165 for test sieves of 200 mm in diameter are listed in the following table:

Mesh size	Max. feed quantity	Max. permitted oversize material according to DIN 66165
25 µm	14 cm ³	7 cm ³
45 µm	20 cm ³	10 cm ³
63 µm	26 cm ³	13 cm ³
125 µm	38 cm ³	19 cm ³
250 µm	58 cm ³	29 cm ³
500 µm	88 cm ³	44 cm ³
1 mm	126 cm ³	63 cm ³
2 mm	220 cm ³	110 cm ³
4 mm	346 cm ³	173 cm ³
8 mm	566 cm ³	283 cm ³

3.8 Feed Grain Size

Traditional dry sieving is performed in the particle size range of 40 µm to 125 mm. With wet sieving the measurement range can be extended to 20 µm. The maximum feed grain size depends on the sample material, the number and aperture size of the test sieves and the type of the sieving machine.

Examples for the maximum feed grain size according to DIN 66165 are listed in the following table:

Mesh size	Max. feed grain size according to DIN 66165	Mesh size	Max. feed grain size according to DIN 66165
22 µm	710 µm	4 mm	25 mm
45 µm	1 mm	8 mm	45 mm
63 µm	1.4 mm	16 mm	71 mm
125 µm	2.5 mm	22.4 mm	90 mm
250 µm	4 mm	45 mm	150 mm

Technical Data

500 µm	6 mm	63 mm	180 mm
1 mm	10 mm	90 mm	230 mm
2 mm	16 mm	125 mm	300 mm

The Vibratory Sieve Shaker AS 200 digit cA is designed for the measurement range of 20 µm to 25 mm.

The Vibratory Sieve Shaker AS 200 digit cA is designed for the measurement range of 20 µm to 25 mm.

3.9 Payload

- Maximum sample quantity: 3 kg
- Maximum sieve stack weight: 4 kg
- Maximum payload: 7 kg (sample material plus test sieves)
- Maximum sieve stack height: 450 mm
- Maximum number of fractions: 9 (height of test sieves and collecting pan: 50 mm (2")) / 18 (height of test sieves and collecting pan: 25 mm (1"))

3.10 Suitable Sieve Diameters

- Suitable sieve diameters: 100 mm / 150 mm / 200 mm / 203 mm (8")

4 Packaging, Transport and Installation

4.1 Packaging

The packaging has been adapted to the mode of transport. It complies with the generally applicable packaging guidelines.

NOTICE

N3.0001

Storage of the packaging

- In the event of a complaint or return, the warranty claim may be endangered if the packaging is inadequate or the device has not been secured correctly.
 - **Keep the packaging for the duration of the warranty period.**
-

4.2 Transport

NOTICE

N4.0017

Transport

- Mechanical or electronic components may be damaged.
 - **The device may not be knocked, shaken or thrown during transport.**
-

NOTICE

N5.0014

Complaints

- The forwarding agent and Retsch GmbH must be notified immediately in the event of transportation damage. It is otherwise possible that subsequent complaints will not be recognised.
 - **Notify your forwarding agent and Retsch GmbH within 24 hour.**
-

4.3 Temperature Fluctuations and Condensation

NOTICE

N6.0016

Temperature fluctuations

The device may be subject to strong temperature fluctuations during transport (e.g. aircraft transport)

- The resultant condensed water may damage electronic components.
 - **Wait before commissioning until the device has been acclimatised.**
-

Temporary storage:

Also in case of an interim storage the device must be stored dry and within the specified ambient temperature range.

4.4 Conditions for the Installation Site

- Installation height: max. 2 000 m above sea level
- Ambient temperature: 5 °C – 40 °C

NOTICE

N7.0021

Ambient temperature

Temperatures outside the permitted range

- Electronic and mechanical components may be damaged.
- The performance data alter to an unknown extent.
- **Do not exceed or fall below the permitted temperature range (5 °C to 40 °C ambient temperature) of the device.**

-
- Maximum relative humidity < 80 % (at ambient temperatures ≤ 31 °C)

For ambient temperatures U_T between 31 °C and 40 °C, the maximum relative humidity value L_F linearly decreases according to $L_F = -(U_T - 55)/0.3$:

Ambient temperature	Max. rel. humidity
≤ 31 °C	80 %
33 °C	73.3 %
35 °C	66.7 %
37 °C	60 %
39 °C	53.3 %
40 °C	50 %

NOTICE

N8.0015

Humidity

High relative humidity

- Electronic and mechanical components may be damaged.
 - The performance data alter to an unknown extent.
 - **The relative humidity in the vicinity of the device should be kept as low as possible.**
-

4.5 Electrical Connection

⚠ WARNING When connecting the power cable to the mains supply, use an external fuse that complies with the regulations applicable to the place of installation.

- Check the type plate for details on the necessary voltage and frequency for the device.
- The listed values must agree with the existing mains power supply.
- Only use the supplied power cable to connect the device to the mains power supply.

NOTICE

N9.0022

Electrical connection

Failure to observe the values on the type plate

- Electronic and mechanical components may be damaged.
- **Connect the device only to mains supply matching the values on the type plate.**

4.6 Type Plate Description

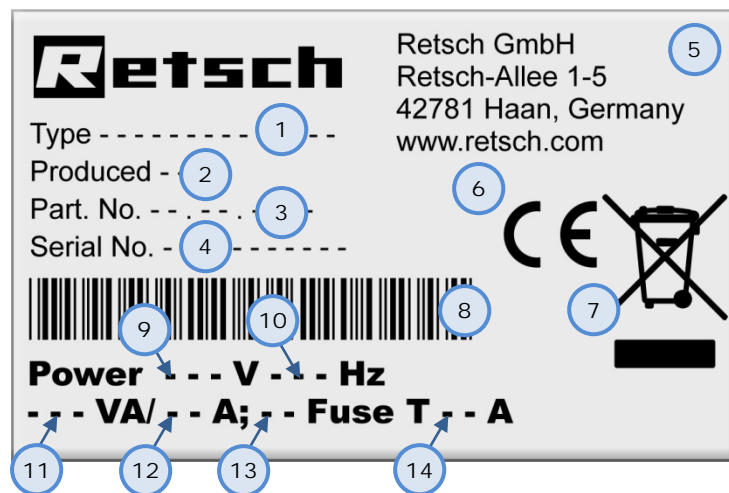

Fig. 1: Type plate

- 1 Device designation
- 2 Year of production
- 3 Part number
- 4 Serial number
- 5 Manufacturer's address
- 6 CE marking
- 7 Disposal label
- 8 Bar code
- 9 Power version
- 10 Mains frequency
- 11 Capacity

- 12 Amperage
- 13 Number of fuses
- 14 Fuse type and fuse strength

① In the case of queries please provide the device designation (1) or part number (3), as well as the serial number (4) of the device.

4.7 Removing the Transportation Lock



WARNING

W2.0005

Serious personal injury

Falling loads

- Due to the heavy weight of the device, serious personal injuries can be caused if it falls down.
 - **Lifting above head height is not permissible!**
-

NOTICE

N10.0018

Transportation lock

Transport without transportation lock, or operation with transportation lock

- Mechanical components may be damaged.
 - **Only transport the device with mounted transportation lock.**
 - **Do not operate the device with built-in transportation lock.**
-

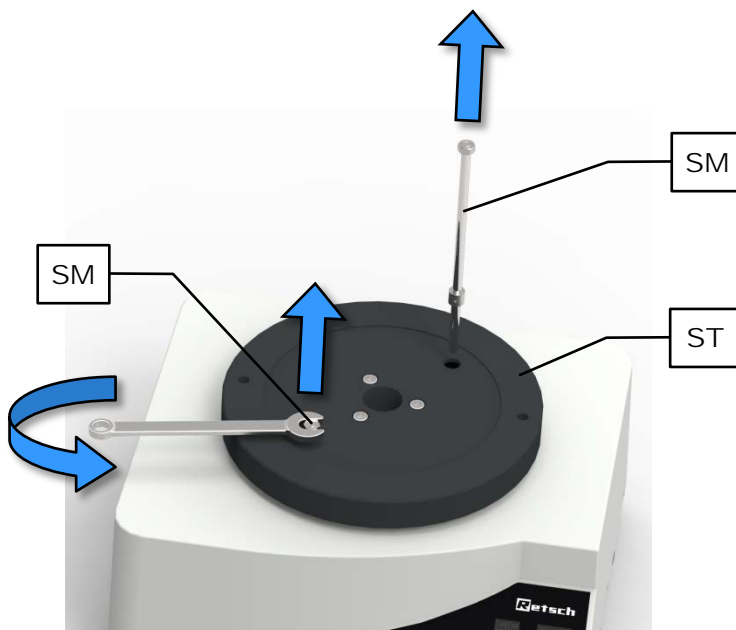

Fig. 2: Removing the transportation lock

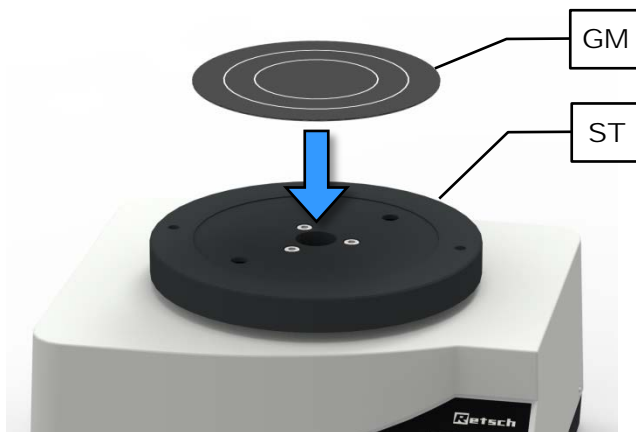

Fig. 3: Mounting the rubber disc

The transportation lock consists of two long hexagonal screws (**SM**) securing the drive through the sieve plate (**ST**).

- ⇒ Loosen the hexagonal screws (**SM**) on both sides of the sieve plate (**ST**) by means of a 13 mm open-end wrench and remove them.
- ⇒ Keep the transportation lock for later transport.
- ⇒ Remove the protective foil from the adhesive tape located on the underside of the rubber disc (**GM**).
- ⇒ Position the rubber disc (**GM**) centrally on the sieve plate (**ST**) and press it down firmly.

NOTICE The weight without sieve stack and sieve clamping unit amounts approx. 35 kg. The device must only be lifted by two people.

5 First Commissioning



WARNING

W3.0002

Danger to life through electric shock

Damaged power cable

- An electric shock can cause burns, cardiac arrhythmia, respiratory arrest, as well as cardiac arrest.
- **Never use a damaged power cable to connect the device to the mains!**
- **Check the power cable and the plug for any damage before use.**



Before first commissioning the sieve clamping unit must be installed.

The AS 200 digit cA is suitable for test sieves of 100 mm to 203 mm outer diameter. Up to 18 fractions (17 test sieves plus collecting pan with a height of 25 mm), or 9 fractions (8 test sieves plus collecting pan with a height of 50 mm) can be clamped.

NOTICE A high number of test sieves can significantly increase the total weight of the load (sieve stack and sample material). Make sure not to exceed the maximum payload of 7 kg.

Different sieve clamping units and lids are available for the test sieves.



Fig. 4: Types of the sieve clamping unit

5.1 Sieve Clamping Unit "economy" and "standard"

- ⇒ Screw one hexagonal nut (**G**) on the lower end of each of the threaded rods (**A**).
- ⇒ Screw both threaded rods (**A**) into the designated threaded holes (**SB**) in the sieve plate (**ST**) and lock them with the hexagonal nuts (**G**).
- ⇒ Firmly tighten the hexagonal nuts (**G**) by means of a 19 mm open-end wrench.
- ⇒ Place the desired [sieve stack](#) including the sample material centrally on the sieve plate (**ST**).
- ⇒ Lay the clamping lid "economy" (**C**) or "standard" (**D**) over the threaded rods (**A**) onto the top test sieve. The top side of the clamping lid "economy" is marked by the Retsch GmbH logo. The clamping lid "standard" is orientated so that the peripheral edge surrounds the test sieves.

- ⇒ Place the washers (**B1**) over the threaded rods (**A**) on top of the clamping lid.
- ⇒ Slide the fixing nut (**B**) in an inclined position of 10° down the threaded rods (**A**) to the clamping lid.
- ⇒ Align the fixing nuts (**B**) vertically so that the thread engages and tight the fixing nuts hand-tight.

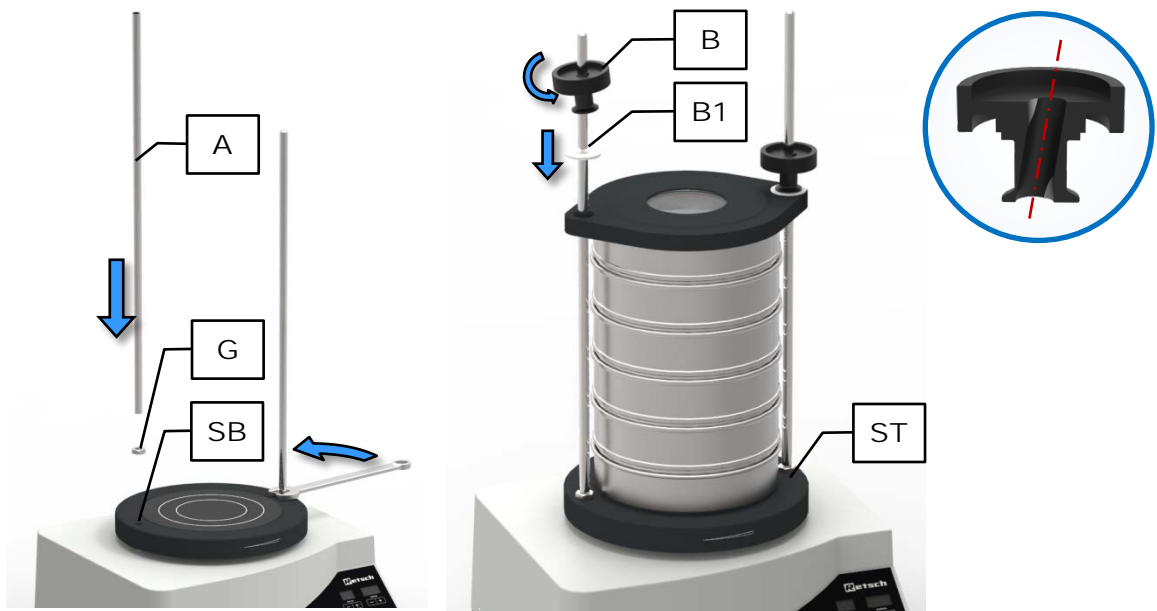

Fig. 5: Installation of the sieve clamping unit "economy" or "standard"

NOTICE To clamp a maximum of five test sieves and a collecting pan, shorter threaded rods are available for the sieve clamping units "economy" and "standard". For sieving processes with only one to three test sieves, the shorter threaded rods should be used. Long, projecting threaded rods disturb the spreading of the sample material due to their natural vibration behaviour.

5.2 Sieve Clamping Unit "comfort"

- ⇒ Put both quick clamping units (**F**) on a flat surface with the green quick clamping lever (**F1**) facing down.
- ⇒ Place the clamping lid (**D**) with the top side (plane side) face down on the quick clamping units (**F**).
- ⇒ Place the O-ring (**OR**) on the cone shaped assembly aid (**MH2**) and slide it down into the designated groove.
- ⇒ Put the assembly aid (**MH2**) in the opening of the clamping lid (**D**) in such a way that the cone shaped tip is sticking out.
- ⇒ Place the assembly aid ring (**MH1**) on the assembly aid (**MH2**) and slide it down. This presses the O-ring on the quick clamping unit and fixes the clamping lid.
- ⇒ Repeat this procedure for the other side.

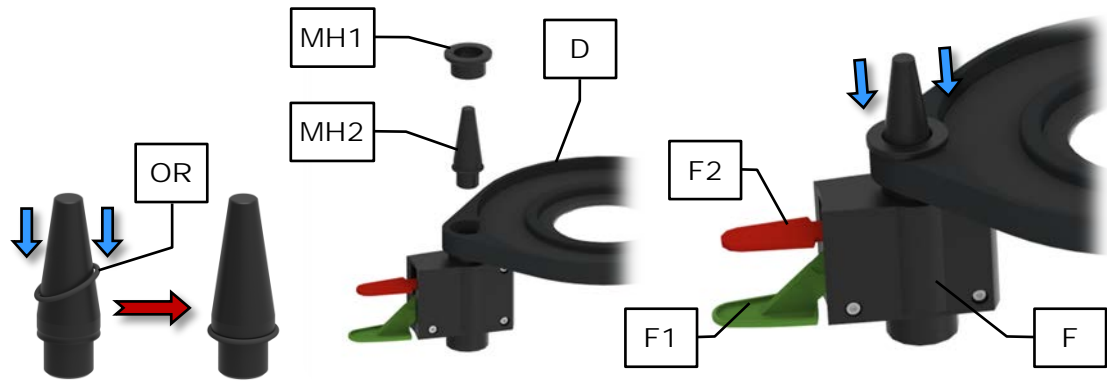

Fig. 6: Assembly of the clamping lid

- ⇒ Screw one hexagonal nut (**G**) on the thread of each of the support rods (**E**).
- ⇒ Screw both support rods (**E**) into the designated threaded holes (**SB**) in the sieve plate (**ST**) and lock them with the hexagonal nuts (**G**).
- ⇒ Firmly tighten the hexagonal nuts (**G**) by means of a 19 mm open-end wrench.

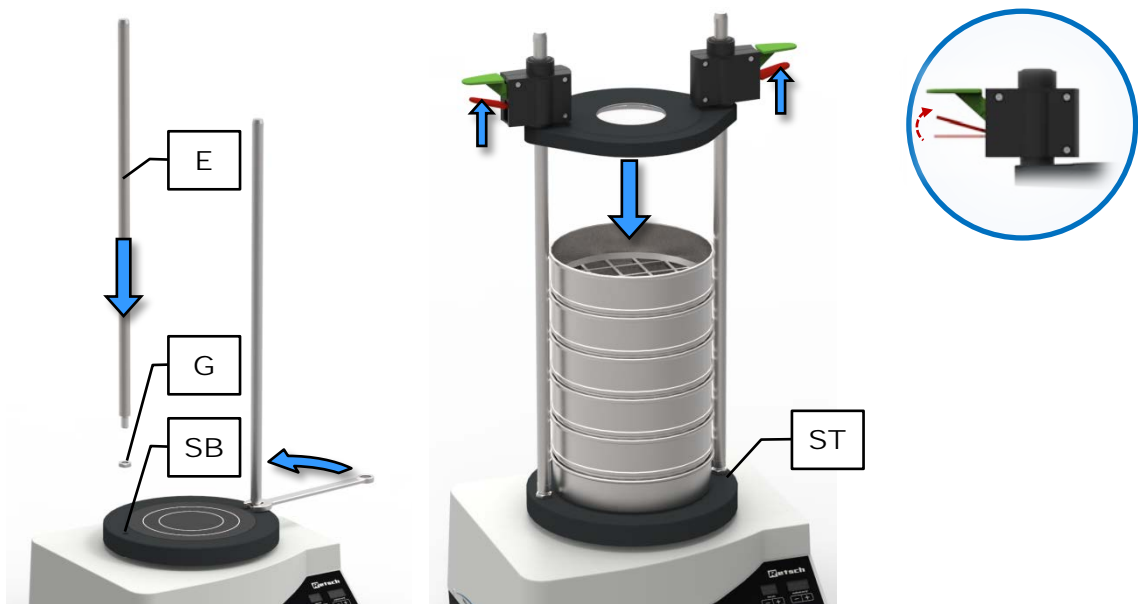

Fig. 7: Installation of the sieve clamping unit "comfort"

- ⇒ Place the desired [sieve stack](#) including the sample material centrally on the sieve plate (**ST**).
- ⇒ Place the assembled clamping lid on the support rods (**E**) with the quick clamping units facing upwards.
- ⇒ Lift the red quick clamping levers (**F2**) of both quick clamping units (**F**) for freely sliding the clamping lid up and down the support rods. Be sure not to push down the green quick clamping levers when doing so.
- ⇒ Slide the quick clamping units with the clamping lid down the support rods (**E**) onto the top test sieve.
- ⇒ When the clamping lid is correctly positioned on the sieve stack, press down the green quick clamping levers (**F1**) 1 – 2 times in order to fix the clamping lid tightly on the sieve stack.

NOTICE Always use both quick clamping units simultaneously! Do not activate both quick clamping levers (red and green) of one quick clamping unit at the same time.

- ⇒ To loosen the clamping lid after the sieving process, lift the red quick clamping levers (**F2**). Keep them lifted and slide the clamping lid upwards until the sieve stack can be removed. There is no need to take off the clamping lid completely from the support rods.



CAUTION

C7.0012

Contusions and bruises

Overturning of the sieve stack

- The sieve stack can overturn and cause personal injury.
 - **Only operate the device with securely clamped sieve stack.**
-

6 Operating the Device

6.1 Use of the Device for the Intended Purpose



WARNING

W4.0010

Handling of food, pharmaceutical and cosmetic products

Analysed products

- Food, pharmaceutical and cosmetic products, which were analysed with the device must not be consumed, used or circulated.
 - **Dispose these substances in accordance with the applicable regulations.**
-



CAUTION

CB.00006

Danger of personal injury

Hazardous sample material

- Depending on the dangerous nature of the sample material necessary measures must be taken to rule out any danger of personal injury.
 - **Observe the material safety data sheets of the sample material.**
-



NOTICE

N11.0007

Range of application of the device

Long-term operation

- This laboratory device is designed for eight-hour single-shift operation with a duty cycle of 30 %.
 - **This device may not be used as a production machine nor is it intended for continuous operation.**
-

This Vibratory Sieve Shaker of the Retsch GmbH is a laboratory device. It is suitable for both, dry and wet sieving of free-flowing, disperse materials in the grain size range from 20 µm to 25 mm.

The particle size distribution of soils, building materials, chemicals, fertilizers, fillers, grains, coffee, plastics, flour, metal powders, minerals, nuts, seeds, sand, washing powder, cement clinker and many other substances can be easily and quickly analysed.

The Vibratory Sieve Shaker of the Retsch GmbH is successfully deployed in almost all areas of industry and research within the scope of quality control, especially where there are high demands regarding easy operability, speed, precision and reproducibility.

The AS 200 digit cA performs a vibratory sieving, where the sample material is thrown upwards by the vibrations of the sieve bottom and subsequently falls back down onto the sieve mesh

fabric due to gravitation forces. Thereby, the sample material is subjected to a three-dimensional movement, i.e. a horizontal circular motion superimposes the vertical throwing motion. Hence, the sample material is spread uniformly across the entire surface of the sieve bottom, whereas the particles are subjected to an acceleration in vertical direction. In this process, they perform free rotations and are compared with the mesh sizes when falling back down statistically orientated. In the Vibratory Sieve Shaker of the Retsch GmbH, an electromagnetic drive sets a spring-mass system in motion and transfers the oscillations to the sieve stack. The amplitude can be adjusted within a few millimetres.

The AS 200 digit cA is specially designed for test sieves with an outer diameter from 100 mm to 203 mm. For an optimum measurement result it is recommended to exclusively use test sieves from Retsch GmbH.

6.2 Views of the Instrument

6.2.1 Front

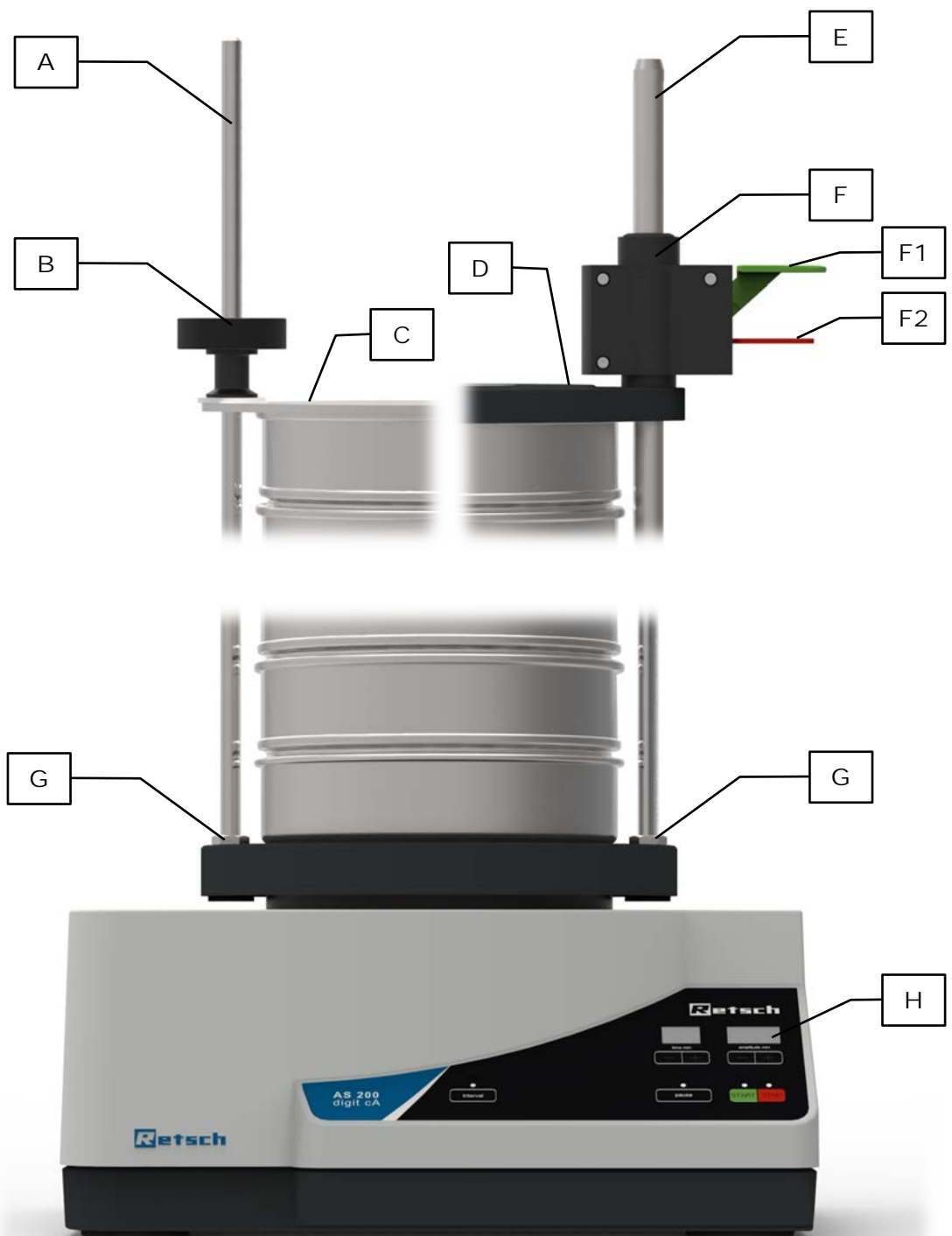

Fig. 8: Front view of the device with different sieve clamping units

Element	Description	Function
A	Threaded rod "economy" and "standard"	Fixes the sieve stack together with the clamping lid (C) or (D) and the fixing nut (B)
B	Fixing nut "economy" and "standard"	Fixes the sieve stack together with the clamping lid (C) or (D) and the threaded rod (A)
C	Clamping lid "economy"	Covers the top test sieve and fixes the sieve stack together with the fixing nut (B) and the threaded rod (A)
D	Clamping lid "standard"	Covers the top test sieve and fixes the sieve stack together with the fixing nut (B) in combination with the threaded rod (A), or the quick clamping unit (F) in combination with the support rod (E)
E	Support rod "comfort"	Fixes the sieve stack together with the clamping lid (D) and the quick clamping unit (F)
F	Quick clamping unit "comfort"	Fixes the sieve stack together with the clamping lid (D) and the support rod (E)
F1	Quick clamping lever green	Moves the clamping lid (D) downwards when being pressed down and hence, fixes the sieve stack
F2	Quick clamping lever red	Releases the clamping lid (D) when being pressed up and hence, the sieve stack
G	Hexagonal nut	Serves as lock nut for the screwed threaded rod (A) or support rod (E)
H	Operating controls	Operation of the device

6.2.2 Back



Fig. 9: Back view of the device

Element	Description	Function
I	Mains switch	Switches the device on and off, disconnects the device from the mains
J	Warning sign "Disconnect from the mains"	Warning of electric shock
K	Mains connection	Connection for the power cable
L	Fuse drawer	Contains the fuses protecting against overvoltage (fuse: 4 A delay-action at 100 – 240 V)
M	Type plate	Lists, among others, the voltage type, the serial number and the type of the device
N	Sticker "Manual"	Reminds to read the manual
O	USB interface	Data transfer between device and PC

6.3 Switching On / Off

⇒ Turn on the AS 200 digit cA with the mains switch (I) on the back side of the device.

When the device is switched off, it is completely disconnected from the mains.

Setting mode:

After switching on, the device is in the setting mode and the LED of the **STOP** button (H1) is lit. The displays "time" (H5) and "amplitude" (H4) show the last used values.

Standby mode:

By pressing the **STOP** button (H1) after power on, the device can be put into standby mode. In this mode, only the LED of the **STOP** button (H1) is lit. All other displays are off. Except for the **START** button (H2), all buttons are inoperable.

6.4 Selection of the Test Sieves

The selection of the test sieves depends on the sample quantity as well as the particle size distribution. The gradation of mesh sizes and accordingly the measurement points should be selected in such a way that the complete particle size range of the sample is covered at regular intervals. The wider the particle size range, the more test sieves should be used.

6.5 Performing a Sieving

- ⇒ Determine the empty weights of the test sieves and the collecting pan.
- ⇒ Place the sieve stack with **increasing** mesh size on the collecting pan.

- ① Each test sieve is provided with an O-ring, which serves as a seal to prevent dust emission during the sieving.

- ⇒ Weigh the sample and put it on the uppermost test sieve (biggest mesh size). Make sure not to exceed the [maximum feed quantity](#).
- ⇒ Place the complete sieve stack centrally on the device and clamp the sieve stack (→ Chapter "[Sieve Clamping Unit "economy" and "standard"](#)" or "[Sieve Clamping Unit "comfort"](#)").
- ⇒ Set the optimum amplitude value and sieving time (→ Chapter "[Controlling the Device](#)").
- ⇒ Start the sieving process.
- ⇒ After the end of the sieving process, weigh the individual test sieves and the collecting pan including the particle size fractions present therein.
- ⇒ Determine the mass of the particle size fractions (weight after the sieving less the respective empty weight).

7 Controlling the Device

7.1 Operating Controls, Displays and Functions

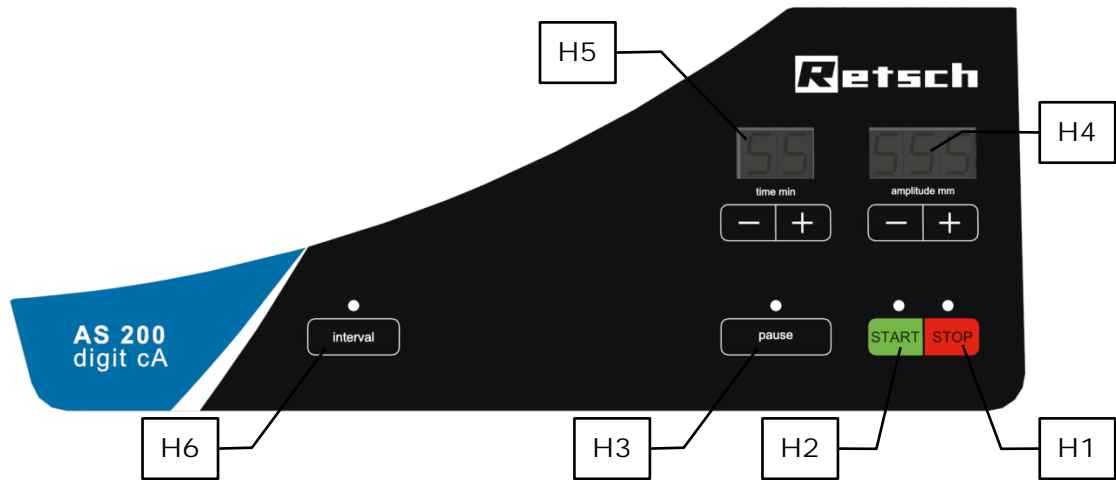

Fig. 10: Operating controls and functions

Element	Description	Function
H1	STOP	Stops the sieving process. In standby mode, the red LED is lit
H2	START	Starts the sieving process. During operation, the green LED is lit
H3	Pause	Interrupts the sieving process. During the pause, the green LED flashes
H4	Amplitude setting	Decreases or increases the amplitude by pressing the "-" or "+" button, respectively in the range of 0.20 to 3.00 mm
H5	Time setting	Reduces or extends the sieving time by pressing the "-" or "+" button, respectively in the range of 1 to 99 minutes
H6	Interval	Switches the device between interval and continuous operation. During the interval operation, the green LED is lit

7.2 Start Process



- ⇒ To start the sieving process in the [setting mode](#), press the **START** button (H2).
- ⇒ If the device is in [standby mode](#), press the **START** button (H2) twice to start the sieving process.

The green LED lights up and the sieving process is started. If a process time has been set beforehand, the time in the display "time" (H5) starts to count down on pressing the **START** button.

7.3 Stop Process

The sieving process will stop automatically after the set process time has elapsed. However, the sieving process can be stopped manually at any time.

⇒ Press the  button (**H1**) to stop the sieving process.

By pressing the  button, the sieving process stops, the red LED lights up and the green LED of the  button (**H2**) turns off.

⇒ Press the  button (**H1**) a second time to put the device into [standby mode](#).

7.4 Pause Process

The sieving process will stop automatically after the set process time has elapsed. However, the sieving process can be interrupted manually at any time.

⇒ Press the  button (**H3**) to interrupt the sieving process.

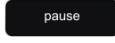
The process time is stopped and the green LED of the  button (**H3**) flashes.

Continue the process:

⇒ Press the  button (**H2**) to continue with the sieving process.

End the process:

⇒ Press the  button (**H1**) to end the sieving process.

7.5 Amplitude

The amplitude display (**H4**) shows the set amplitude value in mm. The amplitude value is adjustable between 0.20 mm and 3.00 mm. When the device is switched on, the last used amplitude is preset.

⇒ Press the "+" or "-" button to set the desired amplitude.

⇒ Press and hold the "+" or "-" button to increase or decrease the amplitude in steps of 0.1 mm, respectively.

The amplitude can also be changed during operation by pressing the "+" or "-" button. An exceeding or falling below of 0.20 mm or 3.00 mm, respectively is not possible.

NOTICE If the set amplitude is not reached, the amplitude display (**H4**) flashes. In this case, decrease the set amplitude, or adjust the load (→ Chapter "[Amplitudes in Dependence on the Load](#)").

During the sieving process, the amplitude is kept constant within a predetermined tolerance of 0.1 mm.

7.5.1 Amplitudes in Dependence on the Load

The AS 200 digit cA is a resonance sieving machine whose attainable amplitude is depending on the load. In this respect, the mass (sieve stack and sieve clamping unit) fixed to the sieve plate (**ST**) plays a primary role. During the sieving process, the amplitude is controlled and kept stable (cA = controlled amplitude).

Only the amplitudes specified within the following load diagram can be achieved. The diagram is to be seen as a guideline for the voltage rated on the type plate (**M**). Mains voltage fluctuations or mains voltage deviations lead to increased tolerances.

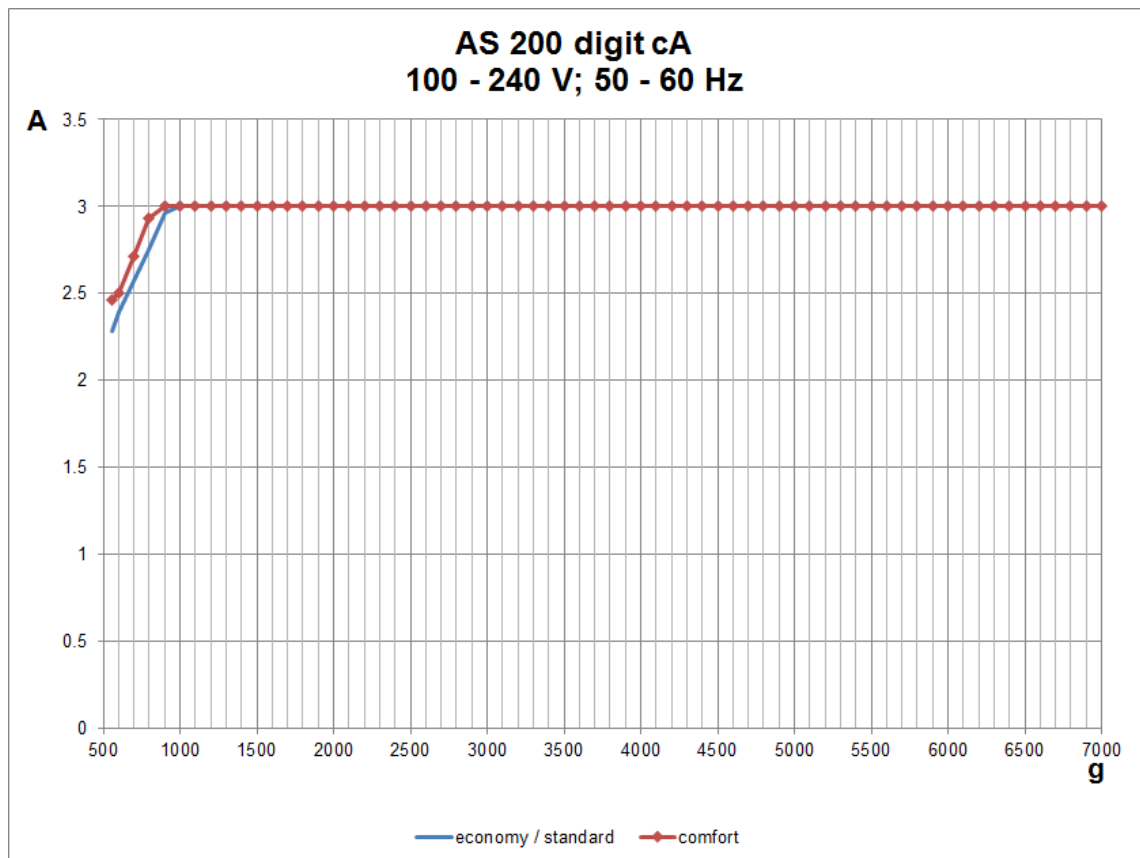

Fig. 11: Load diagram for the sieve clamping units "economy", "standard" and "comfort"

The diagram illustrates the amplitude "A" in millimetre in dependence of the load "g" (sieve stack mass) in gramme. The tolerance of the sieve stack mass amounts $\pm 5\%$. To increase the load at a too low sieve stack mass and hence to reach the maximum amplitude, an [add-on weight](#) of 2 100 g can be additionally mounted. The best results are generally achieved with amplitudes from 1.0 to 1.5 mm.

Example 1:

Type:	230 V; 50 Hz
Sieve stack mass:	1 500 g
Sieve clamping unit:	"comfort"
Add-on weight:	no

Under these conditions the maximum attainable amplitude amounts 3 mm.

Example 2:

Type:	230 V; 50 Hz
Sieve stack mass:	560 g
Sieve clamping unit:	"standard"
Add-on weight:	yes

By using the add-on mass, the maximum attainable amplitude amounts 3 mm. Without the add-on mass, the maximum attainable amplitude would only be ~ 2.3 mm.

7.6 Time



Fig. 12: Time setting for continuous operation (left) or with a process time (right)

The AS 200 digit cA can be operated either in continuous operation or for a certain time between 1 and 99 minutes. When the device is switched on, the last used setting is displayed.

- ⇒ Press the "+" or "-" button of the time display (**H5**) to set the desired process time.
- ⇒ Press and hold the "+" or "-" button to extend or reduce the process time in steps of ten minutes, respectively.
- ⇒ To change to the continuous operation, fall below the duration of 1 min by pressing the "-" button, or exceed the duration of 99 min by pressing the "+" button. The time display (**H5**) now indicates "--".

The process time can also be changed during operation by pressing the "+" or "-" button.

7.7 Optimisation of Time and Amplitude

The settings of the optimum sieving time and amplitude depend on the sample material. These settings have a substantial influence on the measurement result.

Generally, national and international standards, internal regulations and standards provide detailed information on product-specific sieve analyses and the associated sieving parameters. If such basic information cannot be obtained, the sieving time and amplitude must be determined experimentally.

An **optimum amplitude** has been found, when a state of statistical resonance is being reached during the sieving process. Then, the particles have the biggest probability of passing, as the throw time of a particle corresponds to the oscillation period of the sieve mesh fabric. In this case, the particle (**PA1**) will be moved with a different orientation to a different mesh every time the sieve mesh fabric (**SH**) lifts. At too low amplitudes, the particles (**PA2**) do not lift off high enough from the sieve mesh fabric, and are therefore not able to orientate freely and move freely over the sieve mesh fabric. At too high amplitudes, the particles (**PA3**) are thrown up very high, and thus have fewer opportunities to compare themselves with the sieve meshes. The best results are generally achieved with amplitudes from 1.0 to 1.5 mm.

The **optimum sieving time** is in accordance with DIN 66165 achieved, if less than 0.1 % of the feed quantity passes the test sieve after one minute of sieving duration. In practice, the individual test sieves are weighed after the sieving process including the respective particle size fraction. Then, the sieve stack is sieved again for one minute. The weights of the individual test sieves of the second weighing must not differ substantially from those of the first weighing.

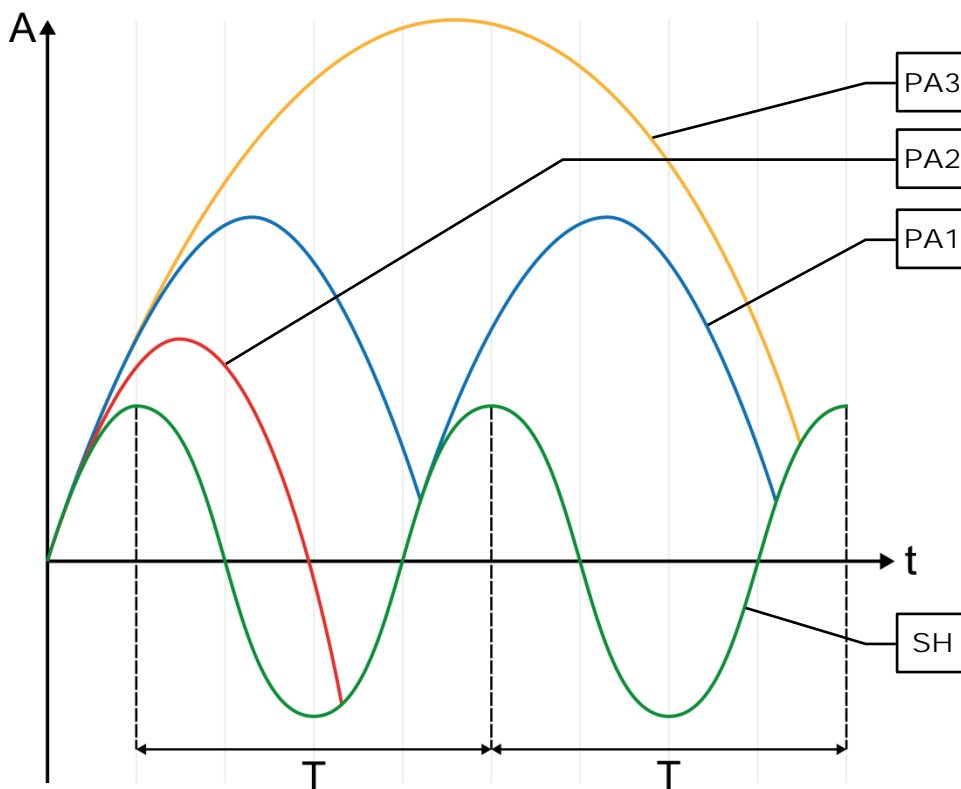

Fig. 13: Movement of the particles on the sieve mesh fabric

7.8 Interval





- ⇒ Press the **interval** button (**H6**) to change to the interval operation. The green LED is lit.
- ⇒ Press the **interval** button (**H6**) again, to change back to the continuous operation. The green LED no longer lights up.

During the interval operation, the sieving process is periodically interrupted for one second. In interval operation, the interval times (pause times) are included in the displayed process time (H5). The interval operation can be switched on and off at any time during the sieving process.

The sieving time between the interval pauses amounts ten seconds. Both, the pause time of one second, as well as the sieving time of ten seconds are not changeable.

7.9 Signal Tone

The end of the sieving process is announced with an acoustic signal.

- ⇒ Simultaneously press the  (H6) and  (H1) button to turn off the signal tone. The process is confirmed by one single signal tone.
- ⇒ Simultaneously press the  (H6) and  (H2) button to turn on the signal tone. The process is confirmed by two single signal tones.

7.10 Operating Hours

- ⇒ Simultaneously press the  button (H3) and the "-" button of the time display (H5).

The time display (H5) indicates "bS" (Betriebsstunden = operating hours) and the amplitude display (H4) displays the complete runtime (corresponds to the accumulated sieving duration) of the device in hhh format. All buttons, except for the  button (H1) are now locked.

- ⇒ Press the  button (H1) to exit the display of the operating hours.

7.11 Software Version

- ⇒ Simultaneously press the  button (H3) and the "+" button of the time display (H5).

The time display (H5) indicates "S" (software) and the amplitude display (H4) displays the current number of the software version. All buttons, except for the  button (H1) are now locked.

- ⇒ Press the  button (H1) to exit the display of the software version.

8 Wet Sieving



WARNING

W5.0001

Danger to life through electric shock

Wet sieving

- An electric shock can cause burns, cardiac arrhythmia, respiratory arrest, as well as cardiac arrest.
 - **Never operate the device in a water drain basin!**
 - **Do not touch the device, if water has entered the interior!**
 - **Always operate the device with a mains socket protected by a residual current circuit breaker (RCCB).**
-



WARNING

W6.0008

Danger to life through electric shock

Ingress of water if the mains plug is not completely plugged in

- Water can enter the IEC socket and cause an electric shock if the mains plug is not completely plugged in.
 - **Only operate the device with the mains plug fully plugged in.**
-

NOTICE

N12.0049

Damage to the sieve mesh fabric

Fluid retention during wet sieving

- Fluid retention can lead to overload and therefore to the damage or destruction of the sieve mesh fabric.
 - **Observe the recommended flow rate.**
 - **Always dose the quantity of liquid applied in such a way that no fluid retention can occur.**
 - **Use venting rings, if necessary.**
-

Usually, sieving processes are carried out dry. However, when agglomerates, electrostatic charges or a high degree of fines impede the sieving process, either [sieving aids](#) can be used, or a wet sieving can be performed.

For wet sieving, a liquid, preferably water, is supplied to the sample material during the sieving process. A condition for wet sieving, however, is that the material to be sieved does not swell, dissolve or otherwise change in the liquid. Wet sieving is particularly suitable for materials which are already in suspension and may not be dried.

In addition to the test sieves, a collecting pan (**AB1**) with an outlet (**AB2**) and a wet sieving lid (**ND1**) with spray nozzle (**ND2**) are required for wet sieving. During the sieving process liquid is

introduces via the spray nozzle (**ND2**) situated on top of the upper most test sieve into the sieve stack and, subsequently, leaving it again together with the last fraction via the outlet (**AB2**) of the collecting pan (**AB1**).

- ⇒ Position the device in the vicinity of the drain point (e.g. drain in the floor). The distance between the outlet (**AB2**) and the drain point should not be too large.
- ⇒ Connect the spray nozzle (**ND2**) of the wet sieving lid (**ND1**) with the liquid supply (e.g. water tap). The inner diameter of the hose must be 13 mm.
- ⇒ Connect the outlet (**AB2**) of the collecting pan (**AB1**) with the drain point or a corresponding receptacle. The inner diameter of the hose must be 20 mm. Make sure that the drain point or the receptacle are located **below** the collecting pan (**AB1**) and that the hose has a **continuous slope down**.

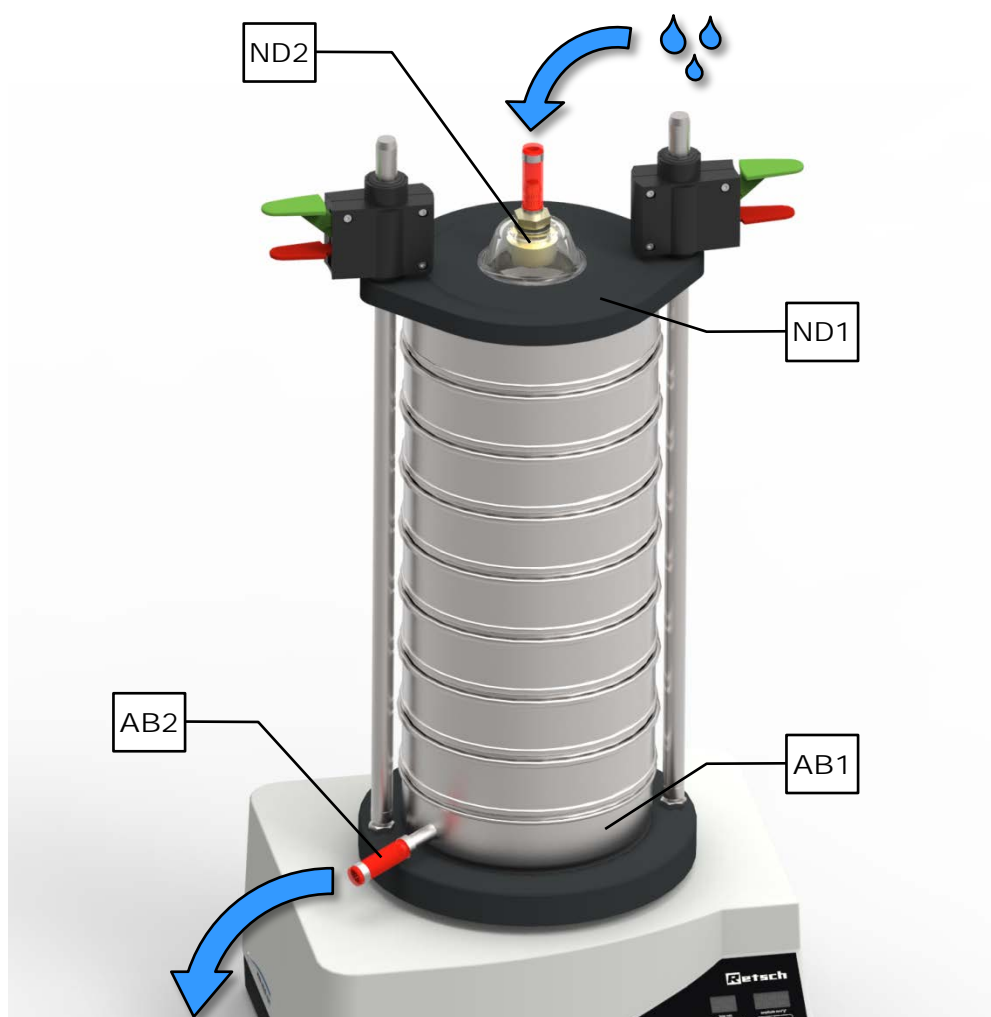

Fig. 14: Wet sieving

- ⇒ Suspend the sample material in a beaker containing the liquid intended for the wet sieving. To reduce the surface tension and to facilitate the screenings of the material later on, a few drops of surfactant may be added.
- ⇒ Moisten each test sieve with the liquid intended for wet sieving.
- ⇒ Place the sieve stack with **increasing** mesh size on the collecting pan with outlet.
- ⇒ Place venting rings (**ER**) between test sieves of mesh size < 100 μm to avoid air cushions.

- ⇒ Place the complete sieve stack centrally on the device.
- ⇒ Enter the sample suspension on the uppermost test sieve with the clamping lid open.
- ⇒ Clamp the sieve stack (→ Chapter "[Sieve Clamping Unit "comfort"](#)").
- ⇒ Set the optimum amplitude value and sieving time (→ [recommended parameters](#)).
- ⇒ Start the sieving process.
- ⇒ Turn on the liquid supply. The quantity of liquid applied should only be of such amount that the sieve mesh area is completely sprayed. A flow rate of 200 to 300 ml per sieve surface in dm^2 and minute is recommended (e.g. 0.5 to 1 litre per minute for sieve diameters of 200/203 mm).
- ⇒ The sieving process is considered as terminated when the exiting liquid shows no turbidity anymore.



Fig. 15: Venting ring

If the smallest fraction, that leaves the collecting pan should also be weighted, it must be appropriately collected. After the sieving process, the individual fractions are transferred on suitable tared filters (paper filter) and dried in an oven at 80 °C until the weight remains constant.

NOTICE Used test sieves must be cleaned immediately after the sieving process (→ Chapter "[Cleaning of Test Sieves](#)"). Depending on the sample material flash rust can form in the sieve mesh fabric.

- ① The [load diagrams](#) are invalid for the wet sieving. Due to the non-defined quantity of liquid in the sieve stack, binding statements are not possible for the wet sieving.

Recommended parameters for wet sieving:



- Amplitude: 1 mm to 1.2 mm
- Interval operation: yes
- Time: 5 min

9 Error Messages and Information Notes

9.1 Error Messages

Error code	Description	Measures
E10	Drive overload	⇒ Switch off the main switch and wait for 30 s before switching on again. ⇒ If the error persists, contact service.
E20	Failure main board	⇒ Switch off the main switch and wait for 30 s before switching on again. ⇒ If the error persists, contact service.
E26	Failure frequency converter	⇒ Switch off the main switch and wait for 30 s before switching on again. ⇒ If the error persists, contact service.

9.2 Information Notes

Notice code	Description	Measures
bS	Display of the complete runtime in hhh	⇒ Press the  button to exit the display.
S	Display of the software version	⇒ Press the  button to exit the display.

10 Return for Service and Maintenance



Fig. 16: Return form

The acceptance of devices and accessories of the Retsch GmbH for repair, maintenance or calibration can only be effected, if the return form including the decontamination declaration service has been correctly and fully completed.

- ⇒ Download the return form located in the download section "Miscellaneous" on the Retsch GmbH homepage (<http://www.retsch.com/downloads/miscellaneous/>).
- ⇒ When returning a device, attach the return form to the outside of the packaging.

In order to eliminate any health risk to the service technicians, Retsch GmbH reserves the right to refuse the acceptance and to return the respective delivery at the expense of the sender.

11 Cleaning, Wear and Maintenance

11.1 Cleaning

**WARNING**

W7.0003

Danger to life through electric shock

Cleaning with water

- An electric shock can cause burns, cardiac arrhythmia, respiratory arrest, as well as cardiac arrest.
- **The power cable must be unplugged before cleaning the device.**
- **Use a cloth dampened with water for cleaning.**
- **Do not clean the device under running water!**

NOTICE

N13.0009

Damage to the housing and device

Use of organic solvents

- Organic solvents may damage plastic parts and the coating.
- **The use of organic solvents is not permitted.**

⇒ Clean the housing of the device with a damp cloth and if necessary, with a household cleaning agent. Pay attention that no water or cleaning agent enters the interior of the device.

11.1.1 Cleaning of Test Sieves

Test sieves are measuring instruments and should be treated with due care before, during and after the sieving process. It is recommended to clean new test sieves before the first use from possible preservative residues with ethanol or isopropanol and to store them in a dry, dust-free place when unused.

Before cleaning or drying the test sieves, the O-rings have to be removed. Before using and after the cleaning the test sieves should be visibly inspected for possible damages and impurities.

Near-mesh or clamped particles can be often removed dry after the sieving process by slightly tapping the test sieve upside down with the sieve frame on a table. For test sieves with mesh sizes > 500 µm a fine hair brush can be used to sweep over the outer side of the mesh fabric.

11.1.1.1 Cleaning of Test Sieves with Mesh Sizes > 500 µm

Coarse mesh fabrics with mesh sizes > 500 µm can be cleaned dry or wet easily and effectively with a hand brush with plastic bristles (at not too high applied pressure). A damage of the mesh fabric by these cleaning tools is not to be expected.

11.1.1.2 Cleaning of Test Sieves with Mesh Sizes < 500 µm

Test sieves with mesh sizes < 500 µm should generally only be cleaned in an ultrasonic cleaning-bath. As cleaning agent, water together with a standard surfactant is recommended. The cleaning in the ultrasonic bath usually takes two to three minutes. After that the test sieves are thoroughly rinsed with water and dried. The cleaning with strong bases or acids is generally not recommended.

11.1.1.3 Drying of Test Sieves

Drying ovens of various sizes can be used for drying test sieves.

Additional information concerning ultrasonic cleaning-baths and drying ovens can be found on the Retsch GmbH homepage (<http://www.retsch.com>). Also ask for the free expert guide *Sieve Analysis – Taking a close look at quality*.

NOTICE

N14.0028

Damage of the sieve mesh fabric

Drying temperature > 80 °C

- At higher temperatures, especially fine metal wire meshes can become warped, leading to a reduced tension of the mesh fabric inside the sieve frame and hence, makes the test sieve less efficient during the sieving process.
- **The drying temperature for test sieves must not exceed 80 °C!**

11.2 Wear

Even with the proper handling of the test sieves, a wearing of the sieve mesh fabric depending on the frequency of the sieving operation and the sample material is unavoidable. The test sieves should be regularly checked for wear and damage and be replaced if necessary.

Likewise, all existing sealing gaskets (of test sieves and clamping lids) should be checked for wear on a regularly basis and replaced if necessary.



CAUTION

C9.0013

Personal injury

Improper repairs

- This manual does not contain any repair instructions.
- **For safety reasons, repairs may only be carried out by Retsch GmbH or an authorised representative or by qualified service technicians.**

11.3 Maintenance

The AS 200 digit cA is largely maintenance-free.

When using the sieve clamping unit "comfort" it is recommended to clean the support rods from time to time. Furthermore, after a certain time the sieve clamping unit "comfort" produces unavoidable, function-related clamping grooves on the support rods, which may impede secure clamping. Therefore, it is necessary to examine the support rods in regularly intervals for clamping grooves in the clamping area and, if required, to turn them by 90°.

- ⇒ Loosen the hexagonal nut (**G**) by means of a 19 mm open-end wrench.
- ⇒ Turn the support rod by 90°.
- ⇒ Then, tighten the hexagonal nut again.

If the rotation of the support rods does not expose a clamping groove free area, the support rods should be replaced.

If wet sieving is executed, a quarterly examination for tightness of the fluid hoses should be performed.

11.3.1 Replacing the Fuses



W8.0014

Danger to life through electric shock

Exposed power contacts

- When replacing the fuses, contact to live contacts on the fuse or the fuse receptacle can lead to an electric shock.
- An electric shock can cause burns, cardiac arrhythmia, respiratory arrest, as well as cardiac arrest.
- **The power cable must be unplugged before exchanging the fuses.**

NOTICE Depending on the mains supply different fuses are used. The correct electrical protection is listed on the type plate (**M**).

Voltage	Fuse
100 – 240 V	4 A delay-action

Two fuses are located in the fuse drawer (**L**) on the backside of the device. Fuses can be replaced by trained qualified personnel.

- ⇒ Remove the fuse drawer by pressing the locking lever on the bottom side of the fuse drawer.
- ⇒ Replace the defective fuse in the fuse drawer.
- ⇒ Slide the fuse drawer back in again, until it audibly locks in place.

12 Accessories

Information on available accessories as well as the respective manuals are accessible directly on the Retsch GmbH homepage (<http://www.retsch.com>) under the heading "Information & Downloads" of the device.

Information on wear parts and small accessories can be found in the Retsch GmbH general catalogue also available on the homepage.

In case of any questions concerning spare parts please contact the Retsch GmbH representative in your country, or Retsch GmbH directly.

12.1 Test Sieves

Decisive for the accuracy and reliability of the measurement result is, in addition to the reproducible operating Vibratory Sieve Shaker the quality of the test sieve. Test sieves of Retsch GmbH are high quality measuring instruments for which only mesh fabrics and perforated sheets of the corresponding standards are used. Each test sieve is tested five times and is given a serial number, as well as a quality certificate after the final check.



Fig. 17: Test sieves

The different versions of the test sieves of Retsch GmbH are supplied in accordance with all current national and international standards:

- available standards: DIN, ISO, ASTM, BS, NF, CGSB
- available diameters: 100 mm / 150 mm / 200 mm / 203 mm (8") / 305 mm (12") / 400 mm / 450 mm (18")
- available sieve surfaces: sieve mesh fabric (20 µm to 125 mm) and perforated screens (round, elongated or square holes) of stainless steel
- on request with an individual test certificate for the inspection of measuring and testing equipment monitoring according to ISO 9000 ff.

Among the various test sieves matching collecting pans, collecting pans with outlet, intermediate pans, intermediate rings, venting rings and sieve lids are available.

12.1.1 Certificate

Before delivery, each test sieve is optically surveyed according to the standards DIN ISO 3310-1 and ASTM E 11, and provided a certificate of compliance with the order.

On request, an additional acceptance test certificate with a calibration protocol can be provided, documenting the measurement results in tabular and graphical form, hence representing a calibration certificate with more detailed statistics.

12.1.2 Calibration Service

As a special service Retsch GmbH offers the calibration of the test sieves. All relevant information are recorded during the standard measuring process of the test sieve and confirmed in the required certificate.

12.2 Sieving Aids

NOTICE

N15.0027

Damage of the sieve mesh fabric

Use of mechanical sieving aids

- When using mechanical sieving aids, there is a danger that fine sieve mesh fabrics might be damaged.
 - **Ensure that no overstretching of the sieve mesh fabric occurs due to overloading with sieving aids.**
 - **If in doubt, please contact your local distributor or Retsch GmbH directly.**
-

By electrostatic and Van-der-Waals forces, as well as by fluid bridges, single particles can combine to form agglomerates. Since in this case not the individual primary particles, but particle collectives are measured, there is a distortion of the particle size distribution (a higher coarse fraction results). In order to prevent the formation of agglomerates or dissolve them, sieving aids can be used.

Mechanical sieving aids:

Mechanical sieving aids cause a destruction of agglomerates and dislodge wedged particles from the sieve meshes. Depending on the mesh size of the test sieve and the preselected amplitude, balls of agate, rubber, steatite or cubes of polyester urethane rubber, and nylon brushes or stainless steel chain rings can be used for this purpose.

NOTICE For very soft sample material, an undesired crushing of primary particles might occur.

Solid additives:

Solid additives, such as talcum or Aerosil® can be admixed to fatty, moist, sticky or oily sample materials. They attach themselves to the particle surface and counteract the formation of agglomerates. Their particle size is so small that they have no sustainable influence to the actual particle size analysis of the sample material. However, the measurement results will be distorted depending on the added amount of additive.

Liquid sieving aids:

Antistatic spray, benzene, alcohol and surfactants can be used as liquid sieving aids, though benzene and alcohol are only to be used during sample preparation. They reduce the electrostatic charges, wash out fatty or oily components of the sample material, or diminish the surface tension in the wet sieving.

12.3 Add-on Weight

If the mass of the sieve stack is too low, the necessary amplitude required for the sieve analysis cannot always be reached. To compensate for this, an additional mass of 2 100 g for test sieves with a diameter ≤ 203 mm can be placed underneath the sieve stack on the sieve plate and be clamped together with the sieve stack.

13 Disposal

In the case of a disposal, the respective statutory requirements must be observed. In the following, information on the disposal of electrical and electronic devices in the European Community are given.

Within the European Community the disposal of electrically operated devices is regulated by national provisions that are based on the EU Directive 2002/96/EC on Waste Electrical and Electronic Equipment (WEEE).

Accordingly, all devices supplied after August 13th 2005 in the business-to-business area, to which this product is classified, may no longer be disposed of with municipal or household waste. To document this, the devices are provided with the disposal label.

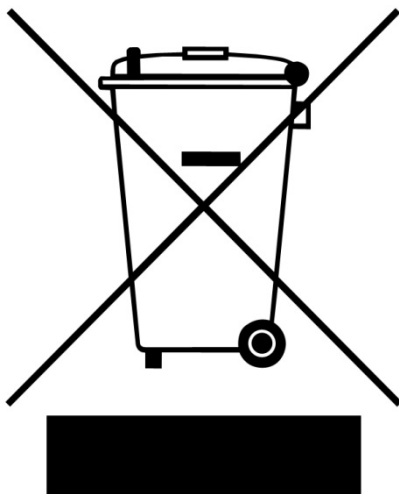

Fig. 18: Disposal label

Since the disposal regulations worldwide and also within the EU may differ from country to country, the supplier of the device should be consulted directly in case of need.

This labelling obligation is applied in Germany since March 23rd 2006. From this date on, the manufacturer must provide an adequate possibility of returning all devices delivered since August 13th 2005. For all devices delivered before August 13th 2005 the end user is responsible for the proper disposal.

14 Index

A

Accessories	45
Action instructions.....	7
Add-on weight.....	33, 47
Ambient temperature	17
Amperage	19
Amplitude.....	32
dependence on the load.....	33
optimisation	34
optimum	35
setting.....	31
Application-technical information.....	6

B

Back	29
Back view.....	29
Bar code	18

C

cA.....	33
Calibration.....	41
Calibration service	46
Capacity	18
CE marking	18
Certificate.....	46
Clamping lid	
assembly	23
economy.....	28
standard	28
Cleaning.....	42
Collecting pan with outlet.....	37
Complaints.....	16
Condensation.....	16
Confirmation form for the managing operator.....	11
Continuous operation.....	34
Controlling the device	31
Copyright	6

D

Degree of protection	12
Depth	13
base.....	13
Device designation	18
Dimensions	13
Disclaimer	6
Displays	31
Disposal	48
Disposal label	18, 48
Disposal regulations	48

E

Electrical connection	18
Electromagnetic compatibility	13
EMC	13
Emissions.....	12
Equivalent continuous sound level	12, 13
Error	
E10	40
E20	40
E26	40
Error messages.....	40
Explanations of the safety instructions	7
External fuse	18

F

Feed grain size	14
Feed quantity	14
First commissioning	21
Fixing nut	28
Frequency	18
Front.....	27
Front view	27
Functions	31
Fuse strength	19
Fuse type	19
Fuses	29
replacing.....	44

G

General catalogue.....	45
General safety instructions	8
Grain size	
range	25

H

Hearing damage	12
Height.....	13
Hexagonal nut.....	28
Humidity	17

I

Information note	
bS	40
S	40
Information notes	40
Installation	16
Installation height.....	17
Installation site	
conditions	17
Interval	31, 35

Index

START	31	description	18
STOP	31	U	
Support rod	28	USB interface	29
Switching on / off	29	Use of the device for the intended purpose	25
Symbols	7	V	
T		Venting ring	39
Target group	8	Vibratory sieving	25
Technical data	12	Views of the instrument	27
Temperature fluctuations	16	Voltage	18
Temperature range	17	W	
Temporary storage	17	Warranty claims	9, 16
Test sieve	26, 45	Wear	42, 43
cleaning	42	Wear parts	45
diameter	21	Weight	13, 20
drying	43	Wet sieving	14, 37
maximum drying temperature	43	liquid	37
selection	30	recommended parameters	39
Threaded rod	28	Wet sieving lid	37
Time	34	Width	13
optimisation	34	base	13
setting	31	Working space	13
Transport	16, 19	Workplace related emission level	12, 13
Transportation damage	16	Y	
Transportation lock	19, 20	Year of production	18
removing	19		
Type plate	18, 29		

VIBRATORY SIEVE SHAKER

AS 200 digit cA | 30.031.xxxx

EU DECLARATION OF CONFORMITY

Herewith we declare, represented by the signatory, that the above mentioned device complies with the following directives and harmonized standards:

Machinery Directive 2006/42/EC

Applied standards, in particular:

DIN EN ISO 12100 Safety of machinery

EMC Directive 2014/30/EU

Applied standards, in particular:

DIN EN 55011 Industrial, scientific and medical equipment - Radio-frequency disturbance characteristics - Limits and methods of measurement

DIN EN 61000-3-2 Electromagnetic compatibility (EMC)

DIN EN 61000-3-3 Electromagnetic compatibility (EMC)

DIN EN 61326-1 Electrical equipment for measurement, control and laboratory use - EMC requirements

Low Voltage Directive 2014/35/EU

Applied standards, in particular:

DIN EN 61010-1 Safety requirements for electrical equipment for measurement, control and laboratory use

Authorized person for the compilation of technical documents:

Dr. Loredana Di Labio (technical documentation)

Furthermore, we declare that the relevant technical documentation for the above mentioned device has been compiled according to Annex VII Part B of the Machinery Directive, and we undertake to submit this documentation on request to the market surveillance authorities.

In case of a modification of the device not previously agreed with Retsch GmbH, as well as the use of unauthorised spare parts or accessories, this declaration will lose its validity.

Retsch GmbH



Dr. Ing. Frank Janetta, Team Leader R&D Department

Haan, 05/2016





Nijverheidsstraat 9,
6987 EN Giesbeek, The Netherlands
T +31 313 880 200
E info@eijkelkamp.com
I royaleijkelkamp.com