

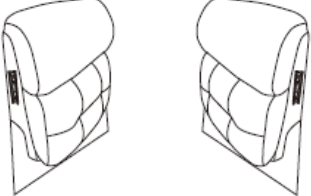

**Assembly Instruction**  
**DOUBLE RECLINING SOFA**  
**ITEM NO.: 194S9980-3**

**NOTE: Do not use power tools for assembly. Power tools increase the risk of over tightening which leads to splitting or cracking the wood.**

**COMPONENT LIST (SOFA)**

NO.	DRAWING	QTY	DESCRIPTION
A		1	SEAT
B	 <p style="text-align: center;">BL      BR</p>	2	BACK REST BL&BR
C		1	MIDDLE BACK REST
D	 <p style="text-align: center;">DL      DR</p>	2	LEFT EAR & RIGHT EAR

**STEP# 1**

**LSF/RSF ear is stores in the bottom of the seat, please take out for assembly.**

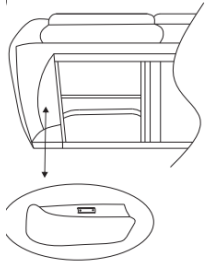

**STEP# 2**

**Insert both ear to back rest.**

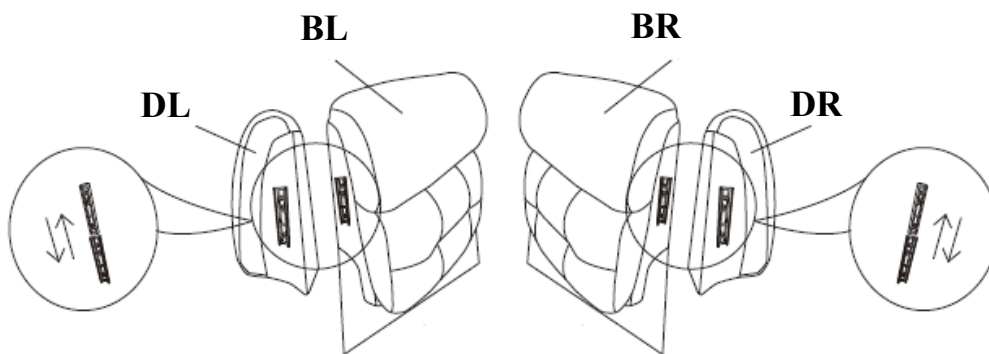

**STEP# 3**

**Align the female brackets at the back onto the male brackets at the seat, insert back rest to the seat and make sure it is fixed in position securely.**

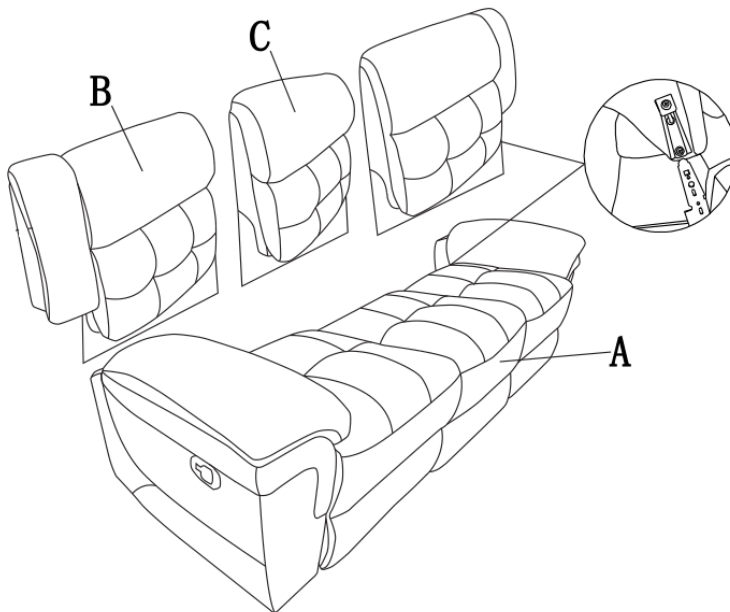

## **Care Instruction for Polyester Furniture.**

In order to maintain the original appearance of your polyester furniture, please follow below simple care procedures:

- Avoid exposing furniture directly to sunlight or heating and air conditioning outlets. Sunlight and/or exposure to heating and air conditioning outlets will fade/damage fabric. Do not place your fabric furniture too close to windows, radiators, or vents.
- Vacuum or wipe with a soft brush to remove dust.



**For items use on wooden floor, hard surfaces or carpets, it is recommended to install protective pads under all legs and supports to avoid/prevent from damages/scratches and discoloration.**