





ASSEMBLY INSTRUCTION

ITEM NO: 194S9857DG-LC

LSF CHAISE

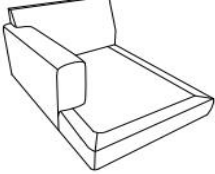
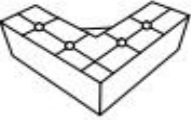
NOTE: Do not use power tools for assembly. Power tools increase the risk of over tightening which lead to splitting or cracking the wood.

PARTS LIST

NO.	DRAWING	QTY	DESCRIPTION
(A)		1	BACK CUSHION
(B)		1	SEAT FRAME
(C)		4	PLASTIC LEG
(D)		16	SCREW
(E)		1	PILLOW
(F)		1	SEAT CUSHION
(G)		1	PLASTIC CENTER SUPPORT LEG

Please follow the drawings below to assemble the item.

Step 1: Legs are stored in the non woven bag at the bottom of the item.
Please take out for assembly.

Step 2

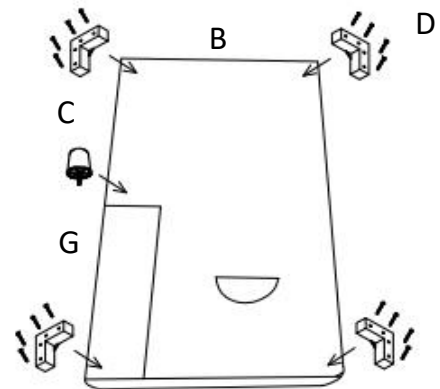
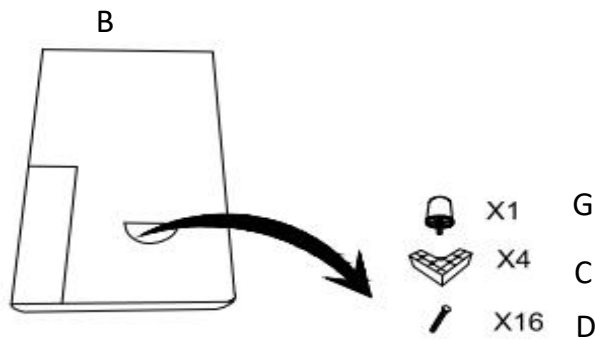

Step 3

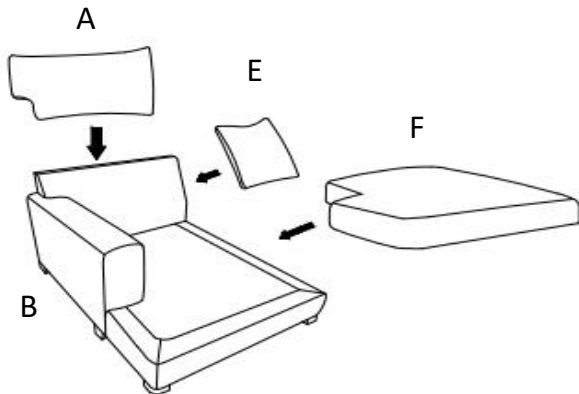

Step 4



CARE INSTRUCTION FOR 100% POLYESTER FURNITURE:

In order to maintain the original appearance of your 100% polyester furniture, please follow below care procedures:

- **Avoid exposing furniture directly to sunlight or heating and air conditioning outlets. Exposure to sunlight or heating and air conditioning outlets will fade /damage 100% polyester.**
- **Wipe gently with a damp soft cloth to remove dust, dirt and any grime buildup.**



For items use on wooden floor, hard surfaces or carpets, it is recommended to Install protective pads under all legs and supports to avoid/prevent from damages/scratches and discoloration.







ASSEMBLY INSTRUCTION

ITEM NO: 194S9857DG-AC

ARMLESS CHAIR

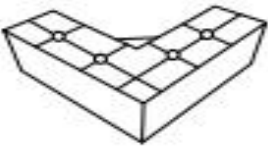
NOTE: Do not use power tools for assembly. Power tools increase the risk of over tightening which lead to splitting or cracking the wood.

PARTS LIST

NO.	DRAWING	QTY	DESCRIPTION
(A)		1	BACK CUSHION
(B)		1	SEAT FRAME
(C)		4	PLASTIC LEG
(D)		16	SCREW
(E)		1	PILLOW
(F)		1	SEAT CUSHION

Please follow the drawings below to assemble the item.

Step 1: Legs are stored in the non woven bag at the bottom of the item.
Please take out for assembly.

Step 2

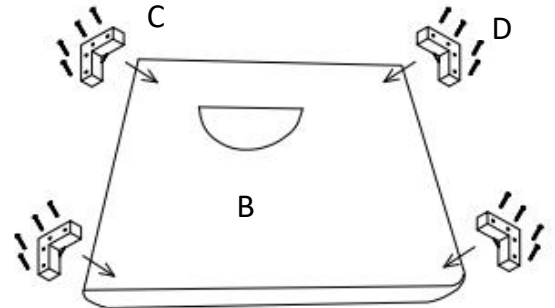
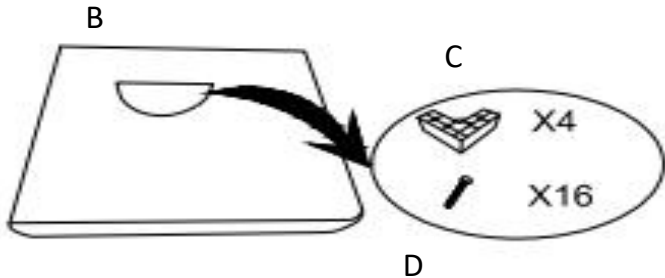

Step 3

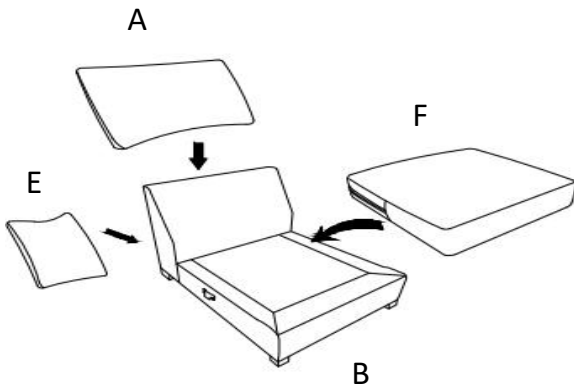

Step 4



CARE INSTRUCTION FOR 100% POLYESTER FURNITURE:

In order to maintain the original appearance of your 100% polyester furniture, please follow below care procedures:

- Avoid exposing furniture directly to sunlight or heating and air conditioning outlets. Exposure to sunlight or heating and air conditioning outlets will fade /damage 100% polyester.
- Wipe gently with a damp soft cloth to remove dust, dirt and any grime buildup.



For items use on wooden floor, hard surfaces or carpets, it is recommended to Install protective pads under all legs and supports to avoid/prevent from damages/scratches and discoloration.





ASSEMBLY INSTRUCTION

ITEM NO: 194S9857DG-CR

CORNER SEAT

NOTE: Do not use power tools for assembly. Power tools increase the risk of over tightening which lead to splitting or cracking the wood.

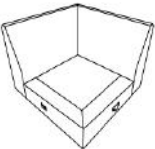
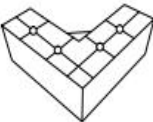
PARTS LIST

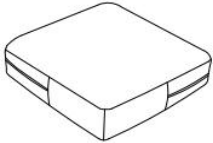
NO.	DRAWING	QTY	DESCRIPTION
(A)		1	RSF BACK CUSHION
(B)		1	LSF BACK CUSHION
(C)		1	SEAT FRAME
(D)		4	PLASTIC LEG
(E)		16	SCREW
(F)		2	PILLOW
(G)		1	SEAT CUSHION

Please follow the drawings below to assemble the item.

Step 1: Legs are stored in the non woven bag at the bottom of the item.
Please take out for assembly.

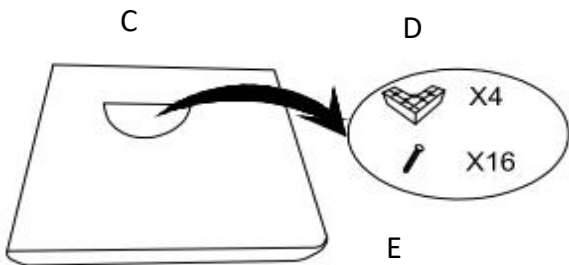

Step 2

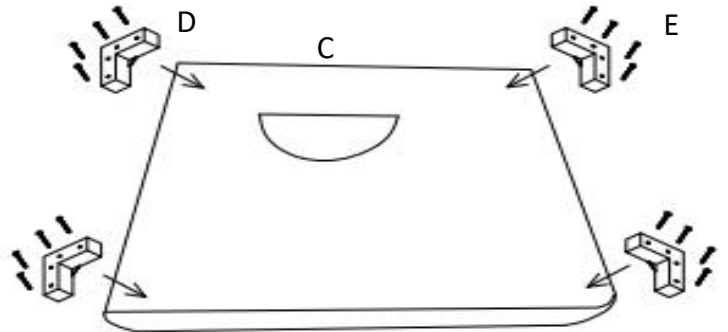

Step 3

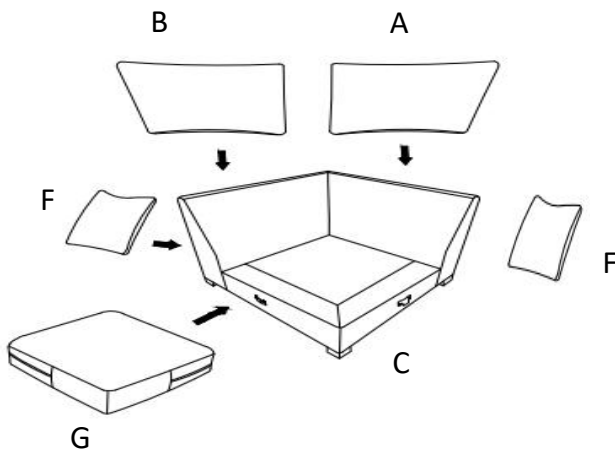

Step 4



CARE INSTRUCTION FOR 100% POLYESTER FURNITURE:

In order to maintain the original appearance of your 100% polyester furniture, please follow below care procedures:

- **Avoid exposing furniture directly to sunlight or heating and air conditioning outlets. Exposure to sunlight or heating and air conditioning outlets will fade/damage 100% polyester.**
- **Wipe gently with a damp soft cloth to remove dust, dirt and any grime buildup.**



For items use on wooden floor, hard surfaces or carpets, it is recommended to Install protective pads under all legs and supports to avoid/prevent from damages/scratches and discoloration.







ASSEMBLY INSTRUCTION

ITEM NO: 194S9857DG-2R

RSF 2-SEATER

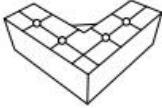
NOTE: Do not use power tools for assembly. Power tools increase the risk of over tightening which lead to splitting or cracking the wood.

PARTS LIST

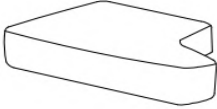
NO.	DRAWING	QTY	DESCRIPTION
(A)		1	LSF BACK CUSHION
(B)		1	RSF BACK CUSHION
(C)		1	SEAT FRAME
(D)		4	PLASTIC LEG
(E)		16	SCREW
(F)		2	PILLOW
(G)		1	LSF SEAT CUSHION
(H)		1	RSF SEAT CUSHION

Please follow the drawings below to assemble the item.

Step 1: Legs are stored in the non woven bag at the bottom of the item.
Please take out for assembly.

Step 2

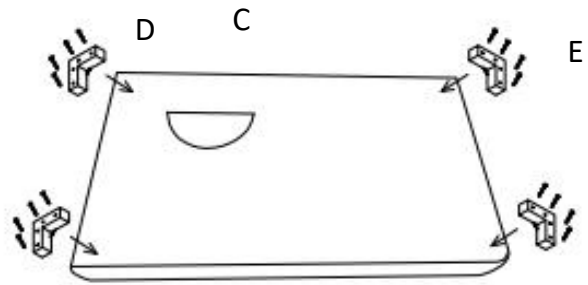
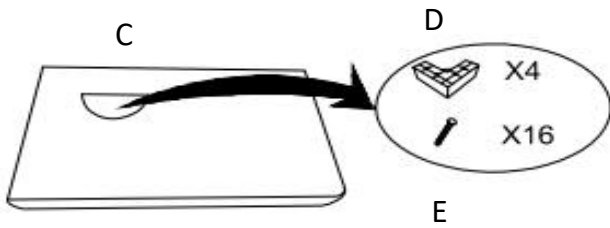

Step 3

Step 4

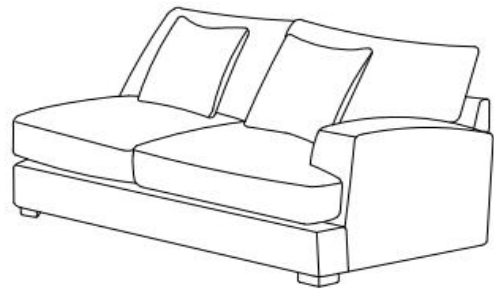
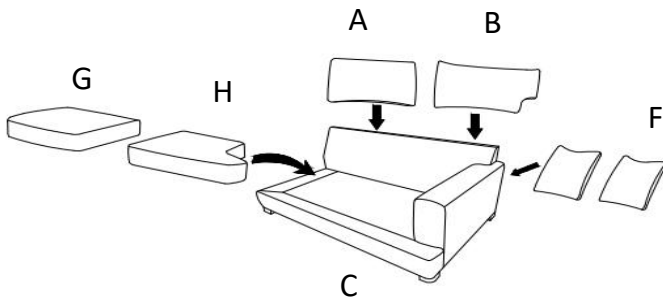

CARE INSTRUCTION FOR 100% POLYESTER FURNITURE:

In order to maintain the original appearance of your 100% polyester furniture, please follow below care procedures:

- Avoid exposing furniture directly to sunlight or heating and air conditioning outlets. Exposure to sunlight or heating and air conditioning outlets will fade /damage 100% polyester.
- Wipe gently with a damp soft cloth to remove dust, dirt and any grime buildup.



For items use on wooden floor, hard surfaces or carpets, it is recommended to Install protective pads under all legs and supports to avoid/prevent from damages/scratches and discoloration.