

Assembly Instruction

ITEM NO: 194S9627CAF/TAN-3





Sofa

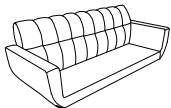
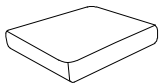

Legs & hardware are packed in the box and stored under the seat cushion, please take out for assembly.

Note: Do not use power tools for assembly. Power tools increase the risk of over tightening which lead to splitting or cracking the wood.

Component list

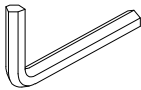
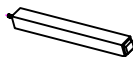
No	Drawing	Qty	Description
A		1	Sofa
B		3	Seat cushions
C		2	Pillows (17"*17")
D		4	Wooden legs (Ø55*Ø45*195mm)
E		12	Bolt 25mm (1/4*25mm)
F		1	Allen key (M4*59mm)
G		1	Support leg (30*30*188mm)

THE PARTS ARE LOCATED INSIDE THE BOX AS BELOW:

WOODEN LEGS

HARDWARE

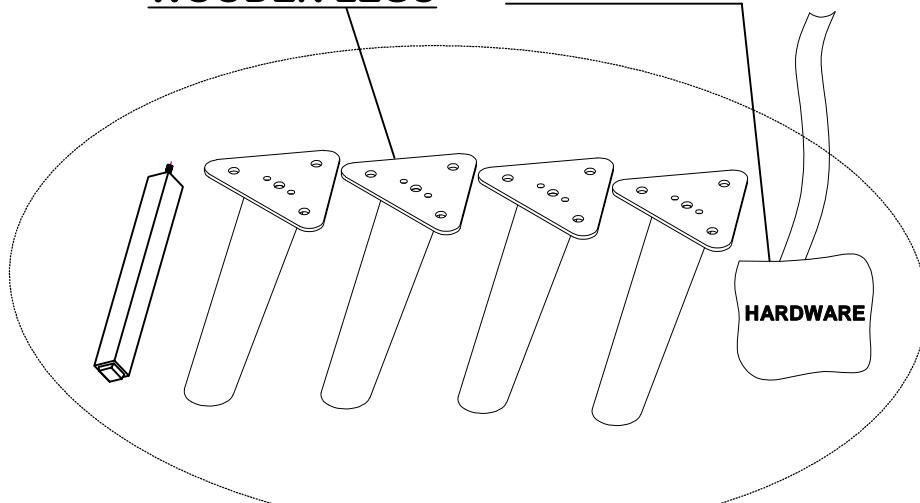

**WOODEN LEGS AND
HARDWARE STORE
UNDER THE SEAT
CUSHION**

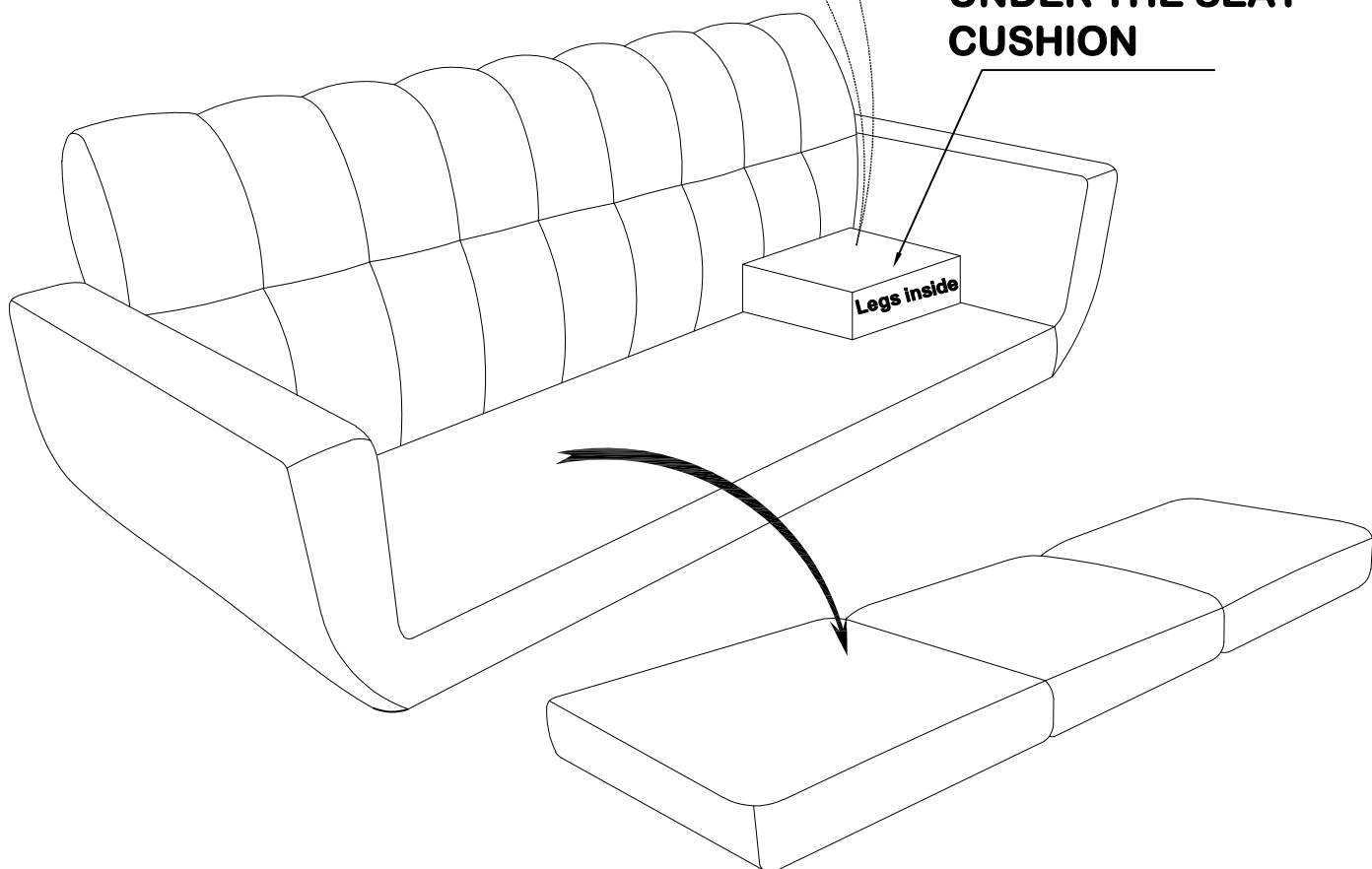

Step #1

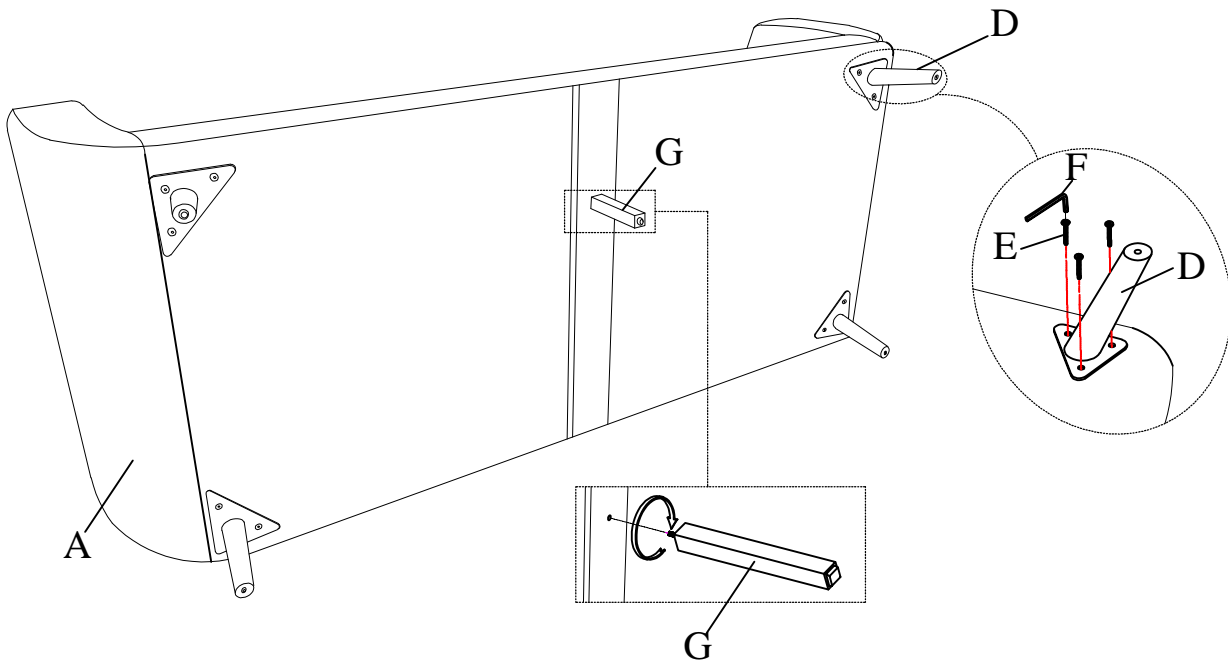

Step #2

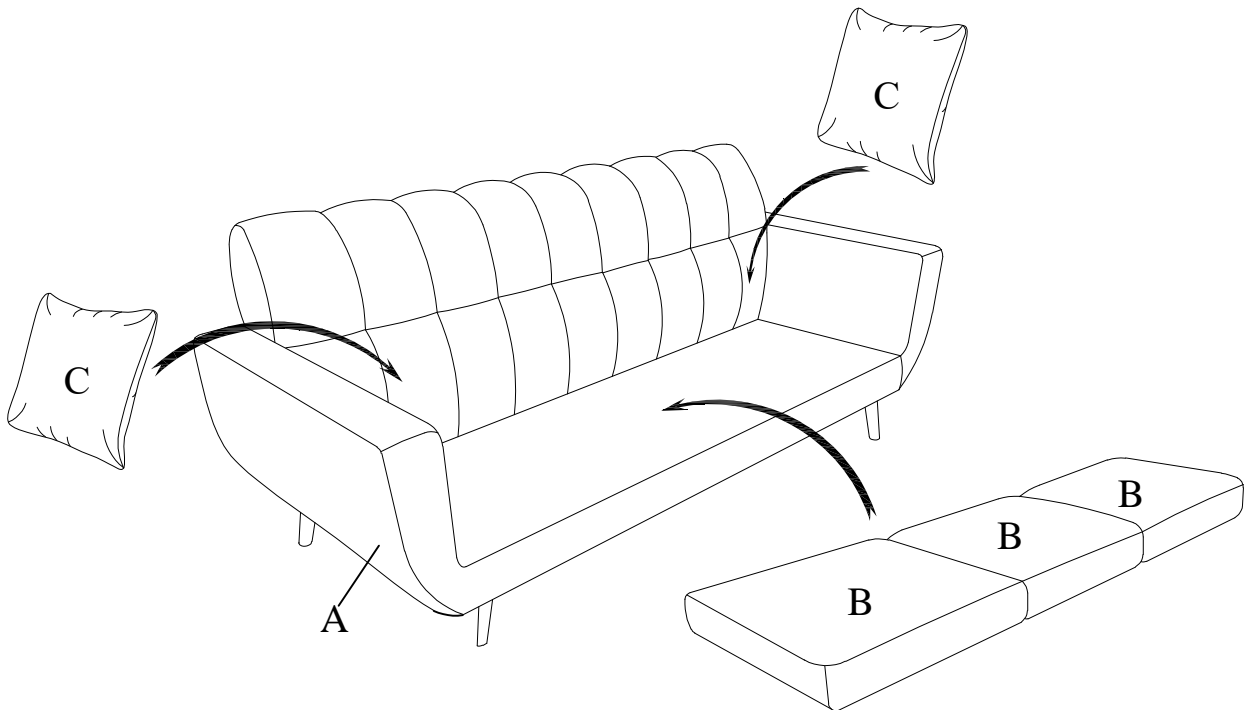

Step #3

Assembly completed.

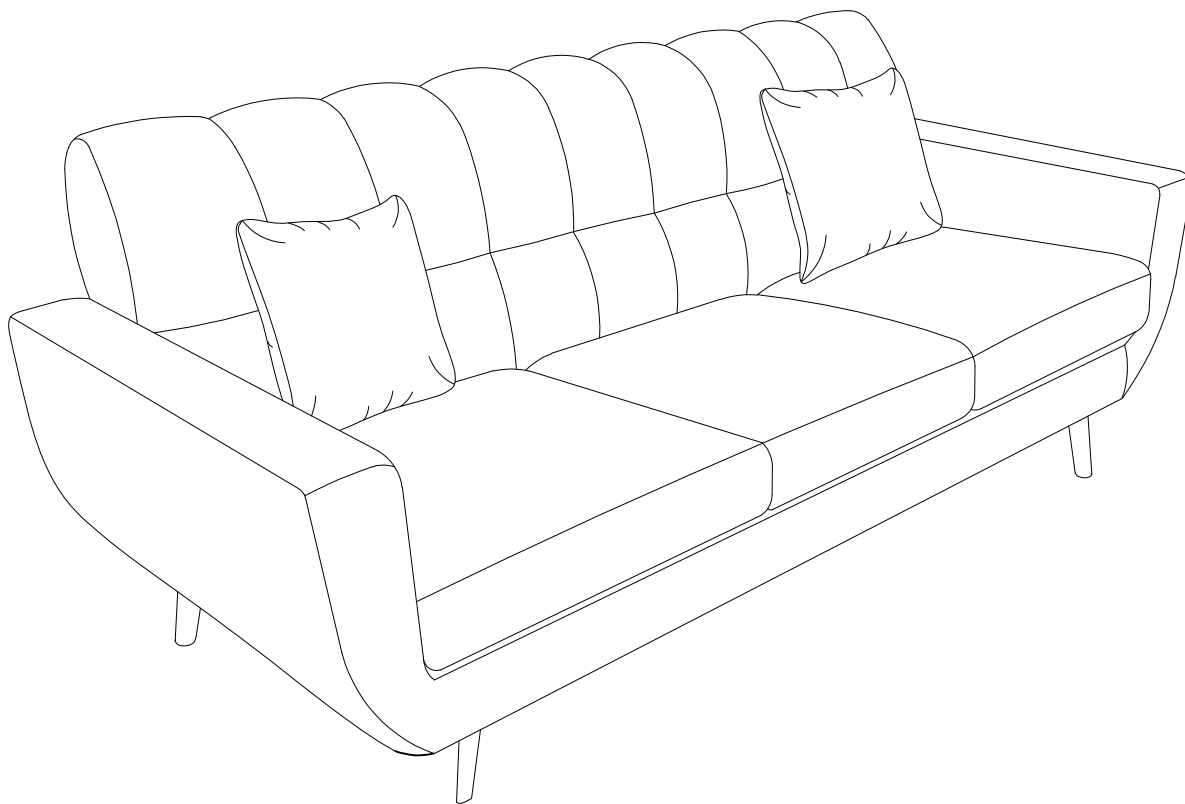

Care Instruction for fabric Furniture:

In order to maintain the original appearance of your Textured Microfiber fabric, please follow below simple care procedures:

- Avoid exposing furniture directly to sunlight or heating and air conditioning outlets. Sunlight and/or exposure to heating and air conditioning outlets will fade/damage fabrics. Do not place your upholstered furniture too close to windows, radiators, or vents, and be sure to use windows, radiators, or vents.
- Vacuum or wipe with a soft cloth to remove dust.
- Hardware may loosen over time. Periodically check to make sure all connections are tight. Re-tighten if necessary.



For items use on wooden floor, hard surfaces or carpets, it is recommended to Install protective pads under all legs and supports to avoid/prevent from damages/scratches and discoloration.