

Assembly Instruction

ITEM NO.: 194S9544GY-L







LSF CHAIR, 1 PILLOW

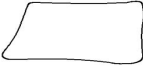

Legs are stored in the bottom of the unit, please take out for assembly.

NOTE: Do not use power tools for assembly. Power tools increase the risk of over tightening which leads to splitting or cracking the wood.

COMPONENT LIST

NO.	DRAWING	QTY	DESCRIPTION
A		1	SEAT
B		1	ARM CUSHION
C		1	BACK CUSHION
D		1	PILLOW
E		4	PLASTIC LEG 1.6"*2.4"
F		1	SEAT CUSHION

Step 1#

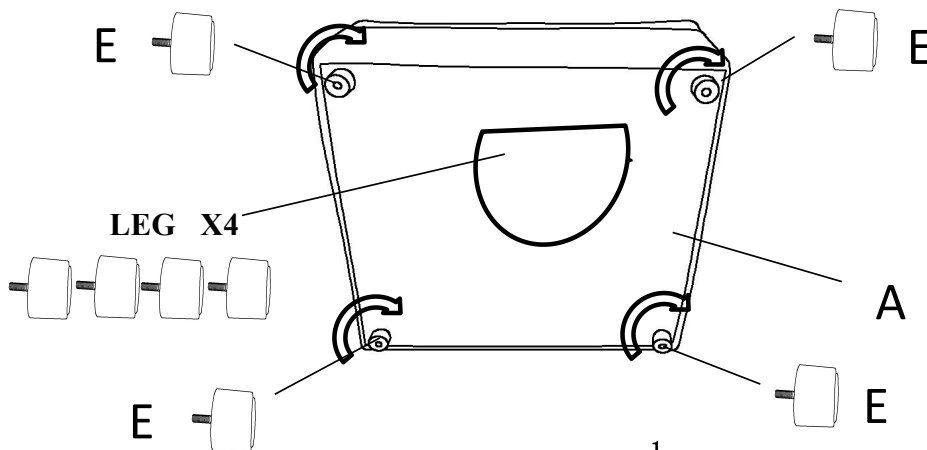

Step #2

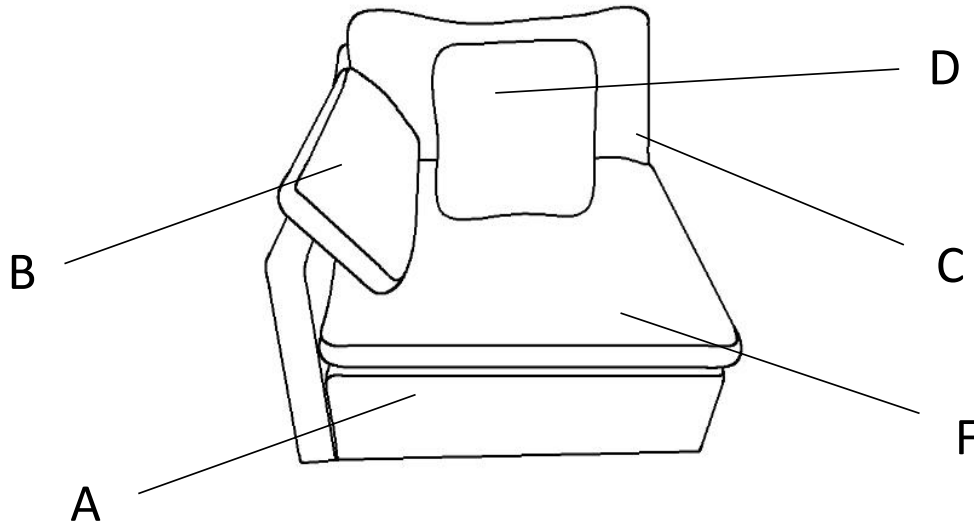

Care Instruction for 100% Polyester Furniture.

In order to maintain the original appearance of your 100% Polyester furniture, please follow below simple care procedures:

- **Avoid exposing furniture directly to sunlight or heating and air conditioning outlets.**

Sunlight and/or exposure to heating and air conditioning outlets will fade/damage 100% Polyester . Do not place your 100% Polyester furniture too close to windows,radiators,or vents.

- **Vacuum or wipe with a soft brush to remove dust.**
- **Do not pull out hang tag.Use scissors to cut off the plastic string.**



For items use on wooden floor, hard surfaces or carpets, it is recommended to Install protective pads under all legs and supports to avoid/prevent from damages/scratches and discoloration.

Assembly Instruction

ITEM NO.: 194S9544GY-AC





ARMLESS CHAIR

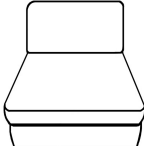

Legs are stored in the bottom of the unit, please take out for assembly.

NOTE: Do not use power tools for assembly. Power tools increase the risk of over tightening which leads to splitting or cracking the wood.

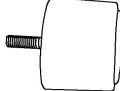
COMPONENT LIST

NO.	DRAWING	QTY	DESCRIPTION
A		1	SEAT
B		1	BACK CUSHION
C		4	PLASTIC LEG 1.6"*2.4"
D		1	SEAT CUSHION

Step 1#

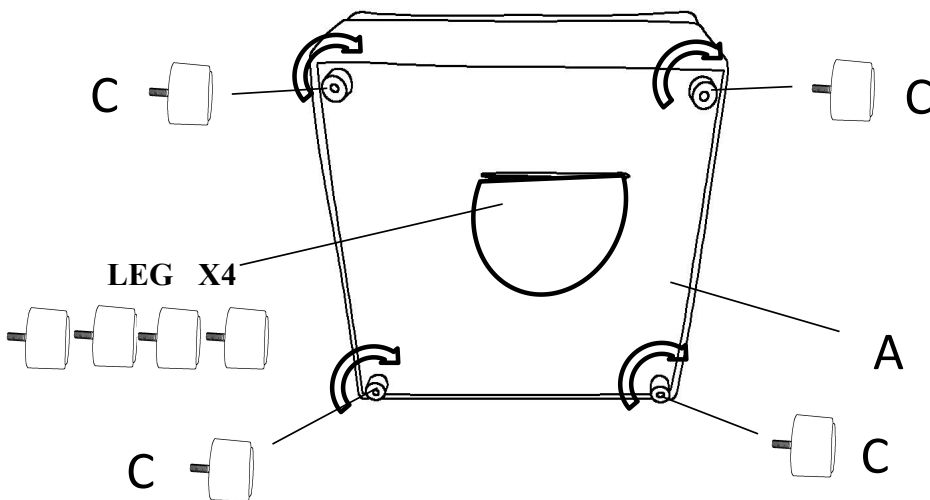

Step#2

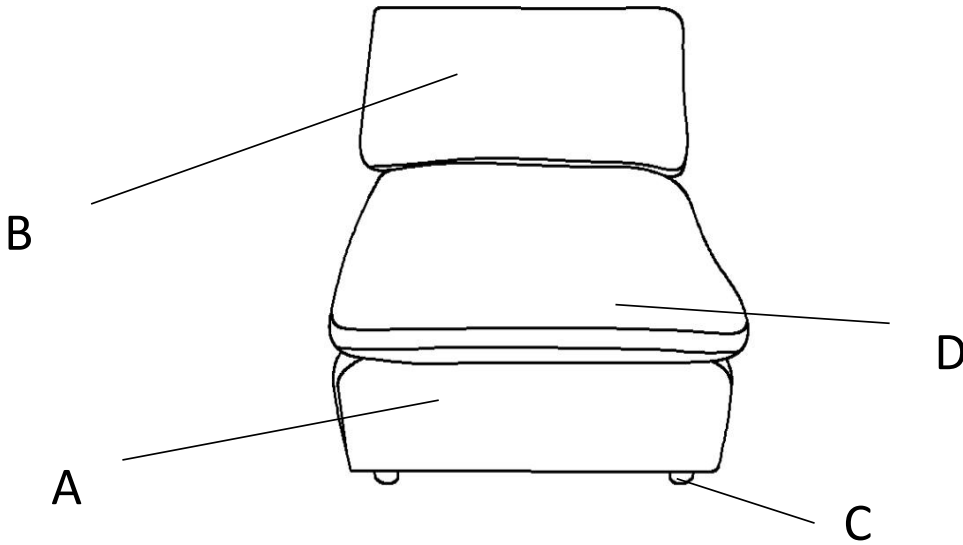

Care Instruction for 100% Polyester Furniture.

In order to maintain the original appearance of your 100% Polyester furniture, please follow below simple care procedures:

- Avoid exposing furniture directly to sunlight or heating and air conditioning outlets.

Sunlight and/or exposure to heating and air conditioning outlets will fade/damage 100% Polyester . Do not place your 100% Polyester furniture too close to windows,radiators,or vents.

- Vacuum or wipe with a soft brush to remove dust.
- Do not pull out hang tag.Use scissors to cut off the plastic string.



For items use on wooden floor, hard surfaces or carpets, it is recommended to Install protective pads under all legs and supports to avoid/prevent from damages/scratches and discoloration.

Assembly Instruction

ITEM NO.: 194S9544GY-CR







CORNER SEAT, 1 PILLOW



Legs are stored in the bottom of the unit, please take out for assembly.

NOTE: Do not use power tools for assembly. Power tools increase the risk of over tightening which leads to splitting or cracking the wood.

COMPONENT LIST

NO.	DRAWING	QTY	DESCRIPTION
A		1	SEAT
B		1	LSF BACK CUSHION
C		1	RSF BACK CUSHION
D		1	PILLOW
E		4	PLASTIC LEG 1.6"*2.4"
F		1	SEAT CUSHION

Step 1#

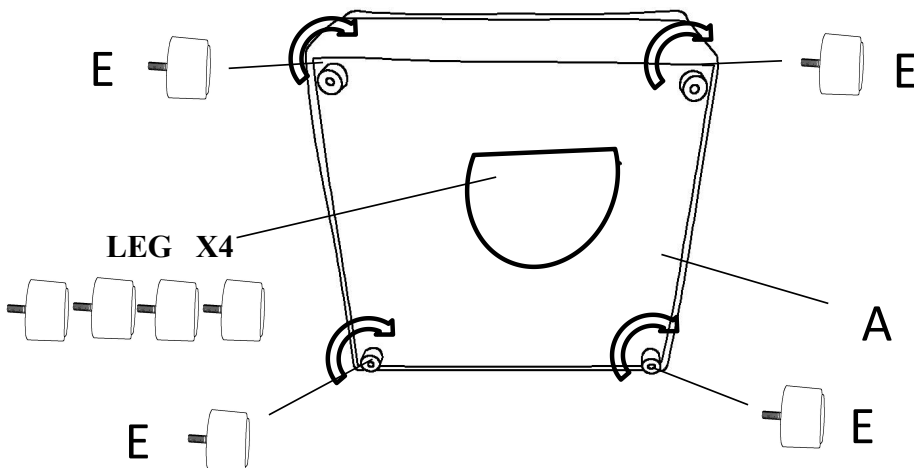

Step #2

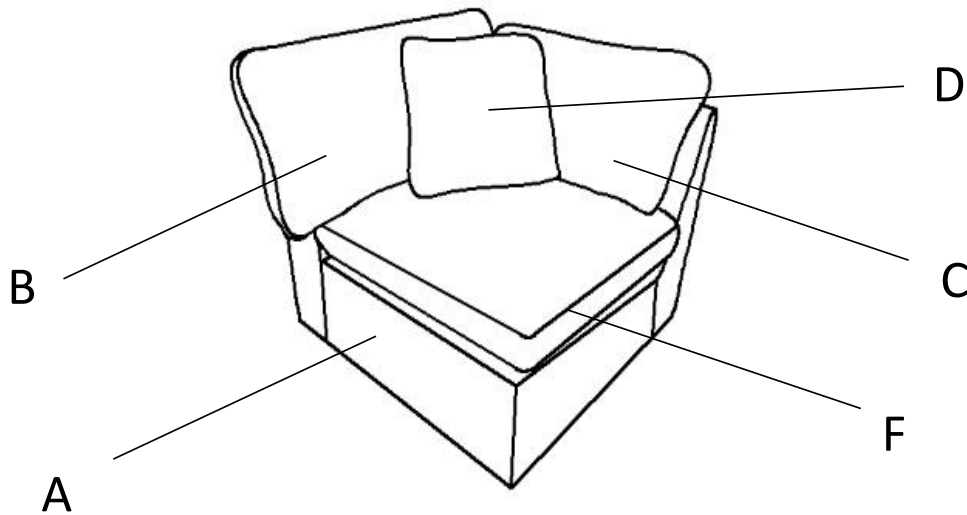

Care Instruction for 100% Polyester Furniture.

In order to maintain the original appearance of your 100% Polyester furniture, please follow below simple care procedures:

- **Avoid exposing furniture directly to sunlight or heating and air conditioning outlets.**

Sunlight and/or exposure to heating and air conditioning outlets will fade/damage 100% Polyester. Do not place your 100% Polyester furniture too close to windows,radiators,or vents.

- **Vacuum or wipe with a soft brush to remove dust.**
- **Do not pull out hang tag.Use scissors to cut off the plastic string.**



For items use on wooden floor, hard surfaces or carpets, it is recommended to Install protective pads under all legs and supports to avoid/prevent from damages/scratches and discoloration.

Assembly Instruction

ITEM NO.: 194S9544GY-R







RSF CHAIR, 1 PILLOW



Legs are stored in the bottom of the unit, please take out for assembly.

NOTE: Do not use power tools for assembly. Power tools increase the risk of over tightening which leads to splitting or cracking the wood.

COMPONENT LIST

NO.	DRAWING	QTY	DESCRIPTION
A		1	SEAT
B		1	BACK CUSHION
C		1	ARM CUSHION
D		1	PILLOW
E		4	PLASTIC LEG 1.6"*2.4"
F		1	SEAT CUSHION

Step 1#

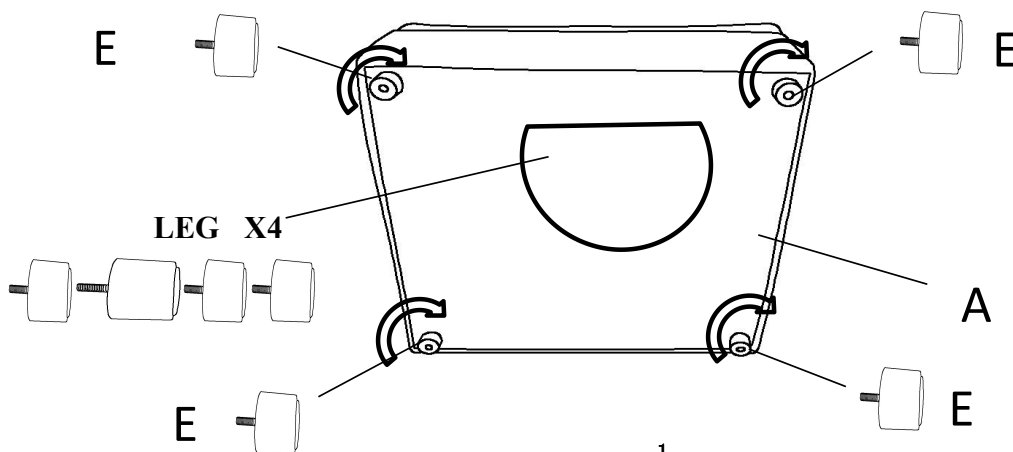

Step #2

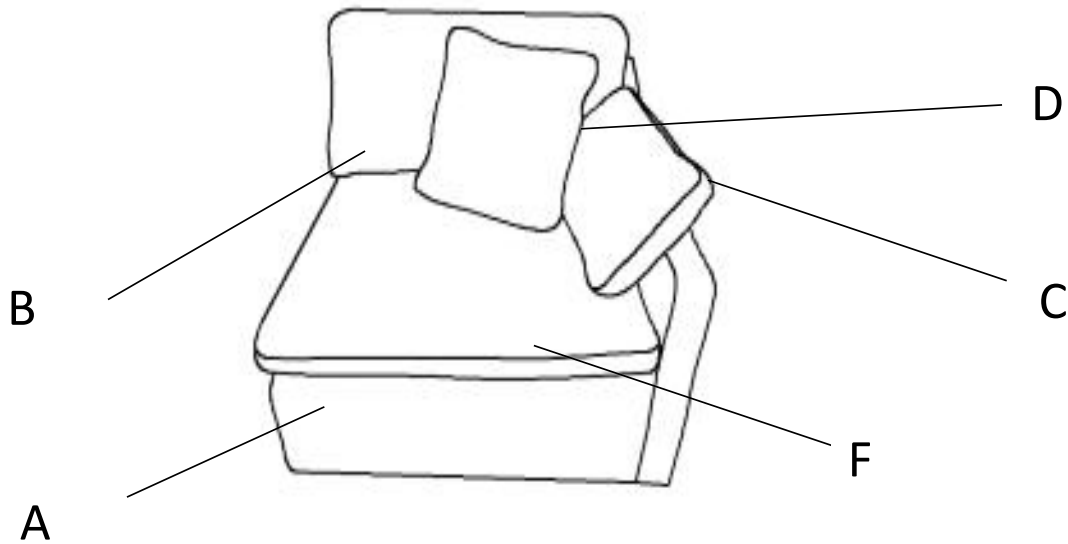

Care Instruction for 100% Polyester Furniture.

In order to maintain the original appearance of your 100% Polyester furniture, please follow below simple care procedures:

- **Avoid exposing furniture directly to sunlight or heating and air conditioning outlets.**
Sunlight and/or exposure to heating and air conditioning outlets will fade/damage 100% Polyester. Do not place your 100% Polyester furniture too close to windows, radiators, or vents.
- **Vacuum or wipe with a soft brush to remove dust.**
- **Do not pull out hang tag. Use scissors to cut off the plastic string.**



For items use on wooden floor, hard surfaces or carpets, it is recommended to Install protective pads under all legs and supports to avoid/prevent from damages/scratches and discoloration.