







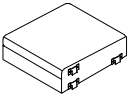
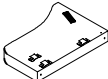

ITEM NO: 194S9489BRW/GRY#3

# Assembly Instruction

## CHAIR

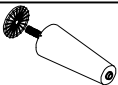
Note: Do not use power tools for assembly. Power tools increase the risk of over tightening which lead to splitting or cracking the wood.

### Component list

No	Drawing	Qty	Description
<b>A</b>		<b>1</b>	<b>SEAT</b>
<b>B1</b>		<b>1</b>	<b>LSF ARM 1PC</b>
<b>B2</b>		<b>1</b>	<b>RSF ARM 1PC</b>
<b>C</b>		<b>1</b>	<b>BACK REST</b>
<b>D</b>		<b>1</b>	<b>SUPPORT BAR</b>
<b>E</b>		<b>4</b>	<b>WOODEN LEG/W PLASTIC WASHER</b>
<b>F</b>		<b>2</b>	<b>BOLT (#1/4"*35mm)</b>
<b>G</b>		<b>2</b>	<b>FLAT WASHER (#1/4"*16*1.5mm)</b>
<b>H</b>		<b>1</b>	<b>ALLEN KEY (M4*59mm)</b>

# Step #1

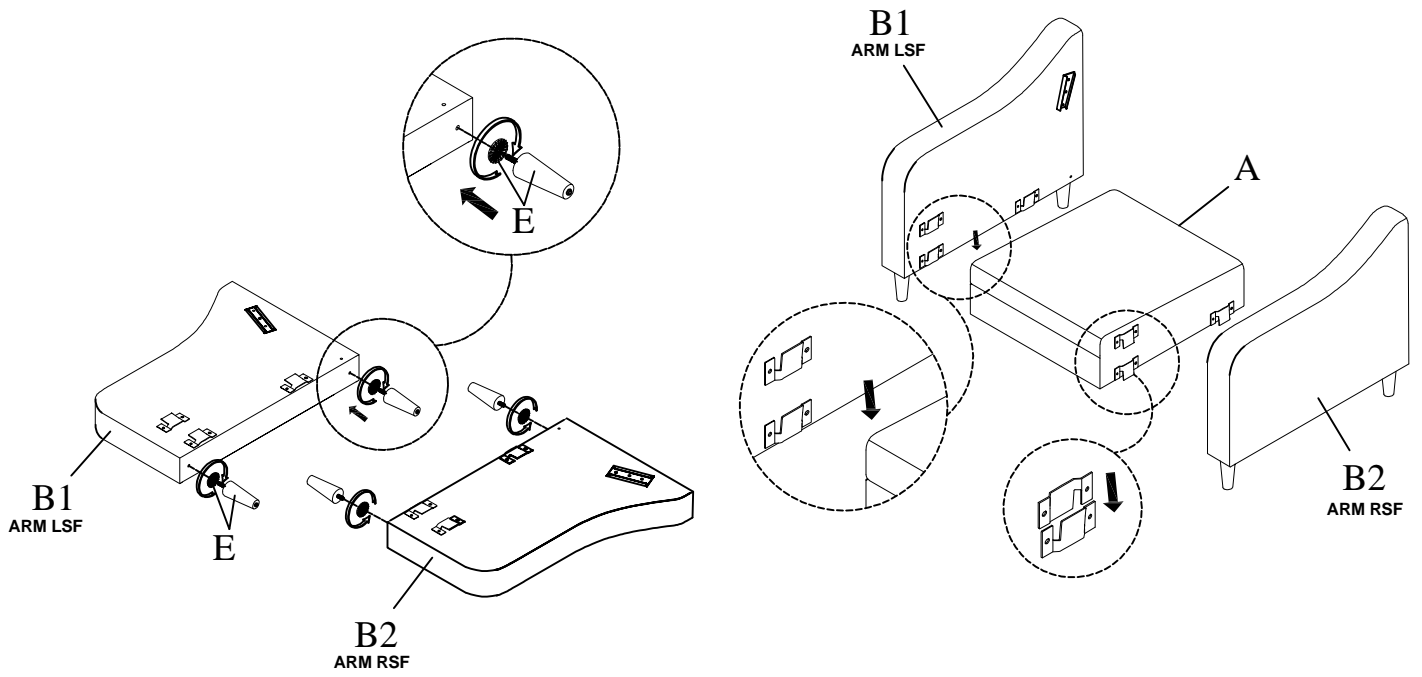

# Step #2

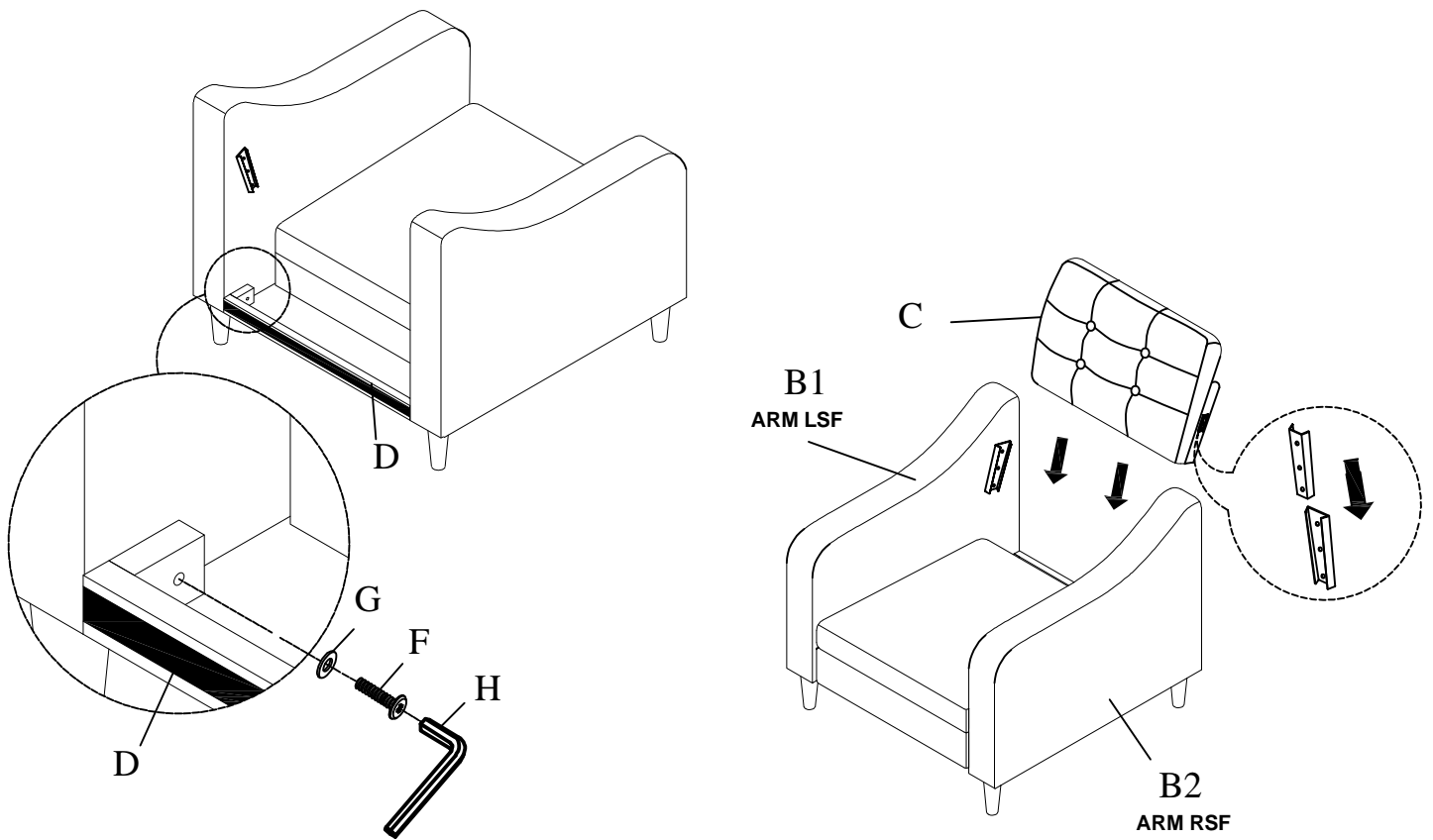

### Step #3

Assembly completed.

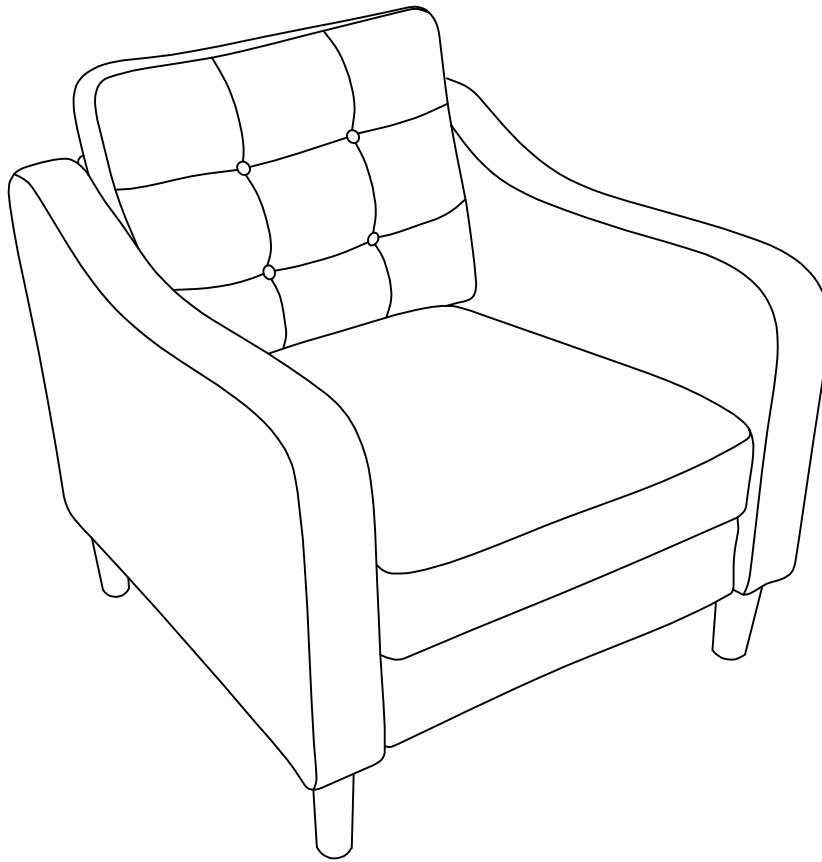

## Care Instruction for fabric Furniture:

In order to maintain the original appearance of your fabric Furniture, please follow below simple care procedures:

- Avoid exposing furniture directly to sunlight or heating and air conditioning outlets. Sunlight and/or exposure to heating and air conditioning outlets will fade/damage fabric. Do not place your fabric furniture too close to windows, radiators, or vents, and be sure to use windows, radiators, or vents.
- Vacuum or wipe with a soft cloth to remove dust.

Hardware may loosen over time. Periodically check to make sure all connection are tight, Re-tighten if necessary.









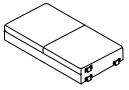

For items use on wooden floor, hard surfaces or carpets, it is recommended to Install protective pads under all legs and supports to avoid/prevent from damages/scratches and discoloration.

# Assembly Instruction

## Love Seat

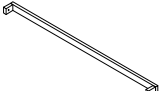
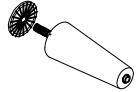
Note: Do not use power tools for assembly. Power tools increase the risk of over tightening which lead to splitting or cracking the wood.

### Component list

No	Drawing	Qty	Description
<b>A</b>		<b>1</b>	<b>SEAT</b>
<b>B1</b>		<b>1</b>	<b>LSF ARM 1PC</b>
<b>B2</b>		<b>1</b>	<b>RSF ARM 1PC</b>
<b>C</b>		<b>1</b>	<b>BACK REST</b>
<b>D</b>		<b>1</b>	<b>SUPPORT BAR</b>
<b>E</b>		<b>4</b>	<b>WOODEN LEG/W PLASTIC WASHER</b>
<b>F</b>		<b>2</b>	<b>BOLT (#1/4"*35mm)</b>
<b>G</b>		<b>2</b>	<b>FLAT WASHER (#1/4"*16*1.5mm)</b>
<b>H</b>		<b>1</b>	<b>ALLEN KEY (M4*59mm)</b>

# Step #1

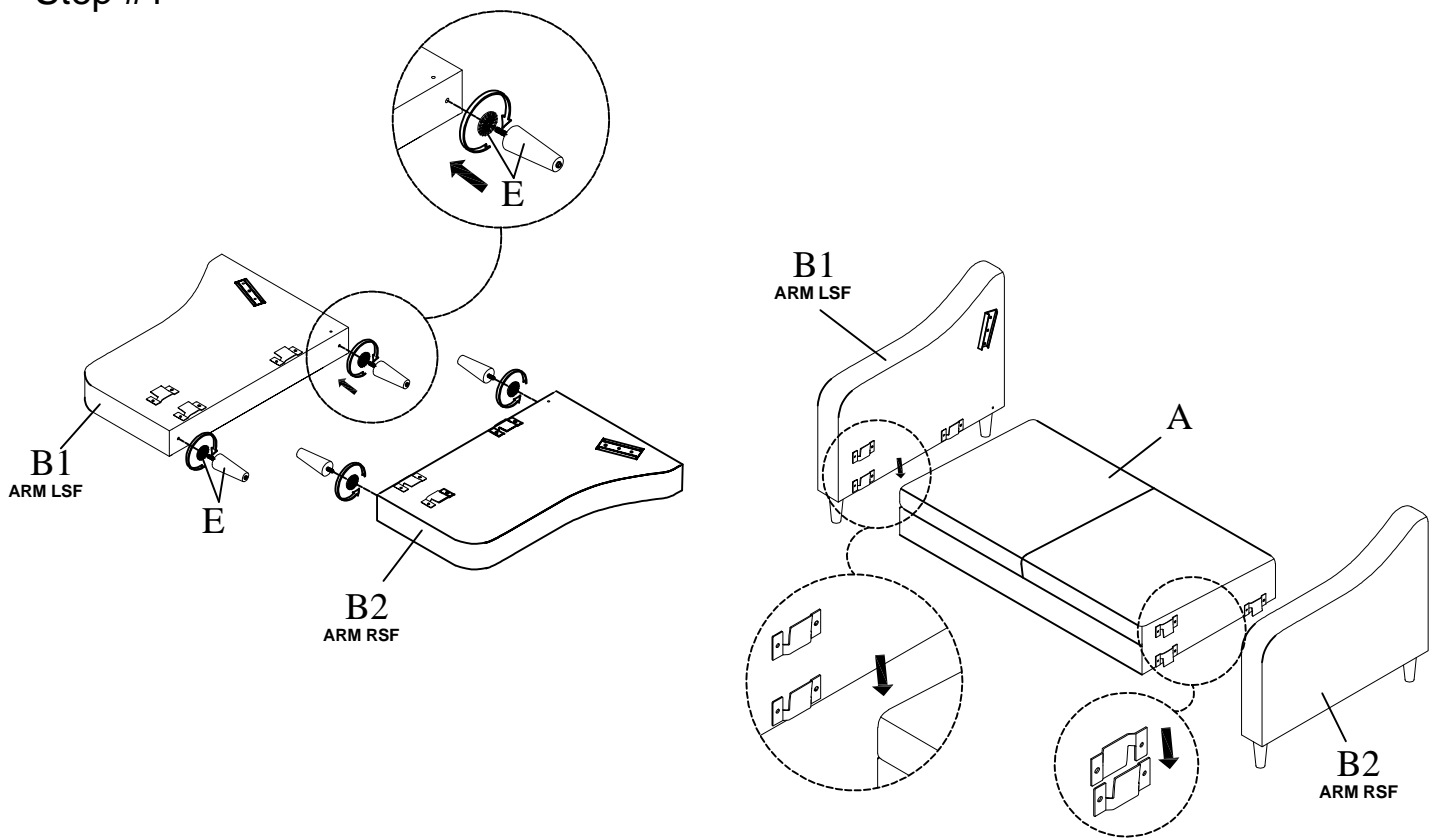

# Step #2

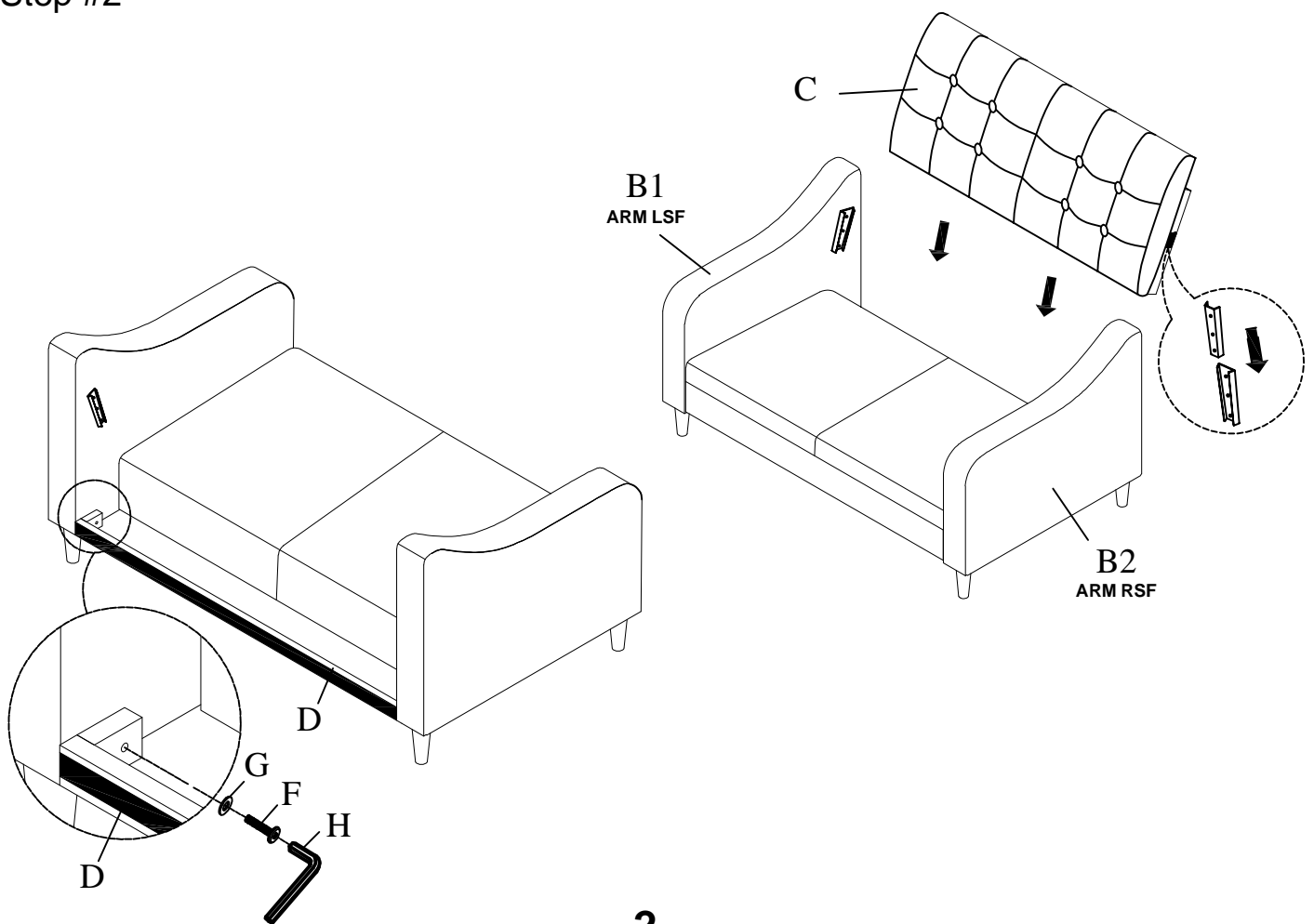

### Step #3

Assembly completed.

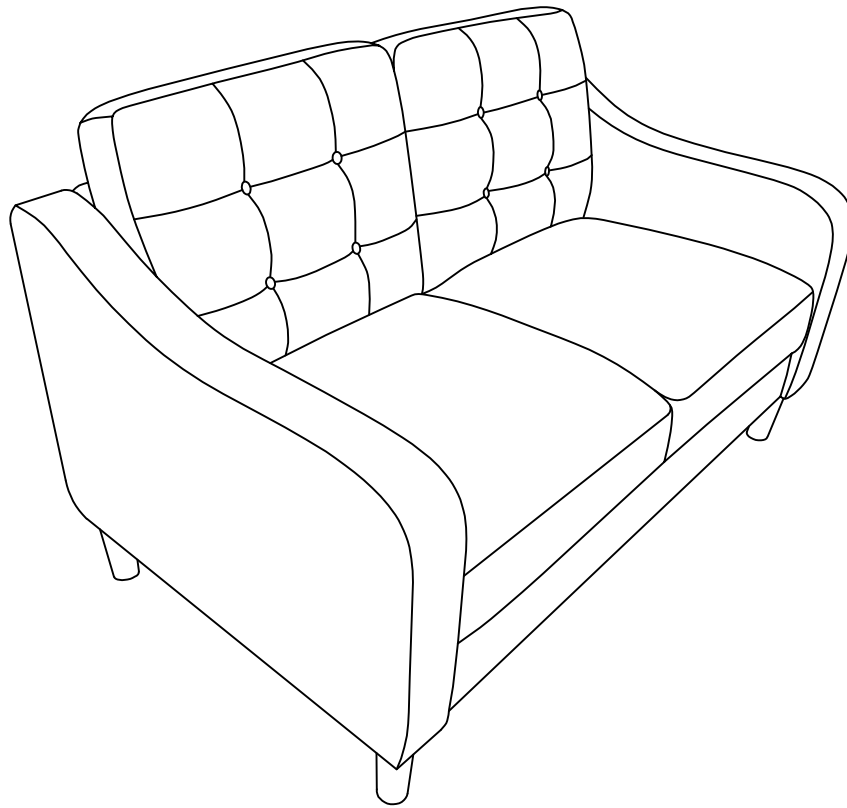

## Care Instruction for fabric Furniture:

In order to maintain the original appearance of your fabric Furniture, please follow below simple care procedures:

- Avoid exposing furniture directly to sunlight or heating and air conditioning outlets. Sunlight and/or exposure to heating and air conditioning outlets will fade/damage fabric. Do not place your fabric furniture too close to windows, radiators, or vents, and be sure to use windows, radiators, or vents.
- Vacuum or wipe with a soft cloth to remove dust.

Hardware may loosen over time. Periodically check to make sure all connection are tight, Re-tighten if necessary.









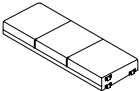

For items use on wooden floor, hard surfaces or carpets, it is recommended to Install protective pads under all legs and supports to avoid/prevent from damages/scratches and discoloration.

# Assembly Instruction

## Sofa

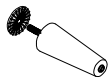
Note: Do not use power tools for assembly. Power tools increase the risk of over tightening which lead to splitting or cracking the wood.

### Component list

No	Drawing	Qty	Description
<b>A</b>		<b>1</b>	<b>SEAT</b>
<b>B1</b>		<b>1</b>	<b>LSF ARM 1PC</b>
<b>B2</b>		<b>1</b>	<b>RSF ARM 1PC</b>
<b>C</b>		<b>1</b>	<b>BACK REST</b>
<b>D</b>		<b>1</b>	<b>SUPPORT BAR</b>
<b>E</b>		<b>4</b>	<b>WOODEN LEG/W PLASTIC WASHER</b>
<b>F</b>		<b>2</b>	<b>BOLT (#1/4"*35mm)</b>
<b>G</b>		<b>2</b>	<b>FLAT WASHER (#1/4"*16*1.5mm)</b>
<b>H</b>		<b>1</b>	<b>ALLEN KEY (M4*59mm)</b>

# Step #1

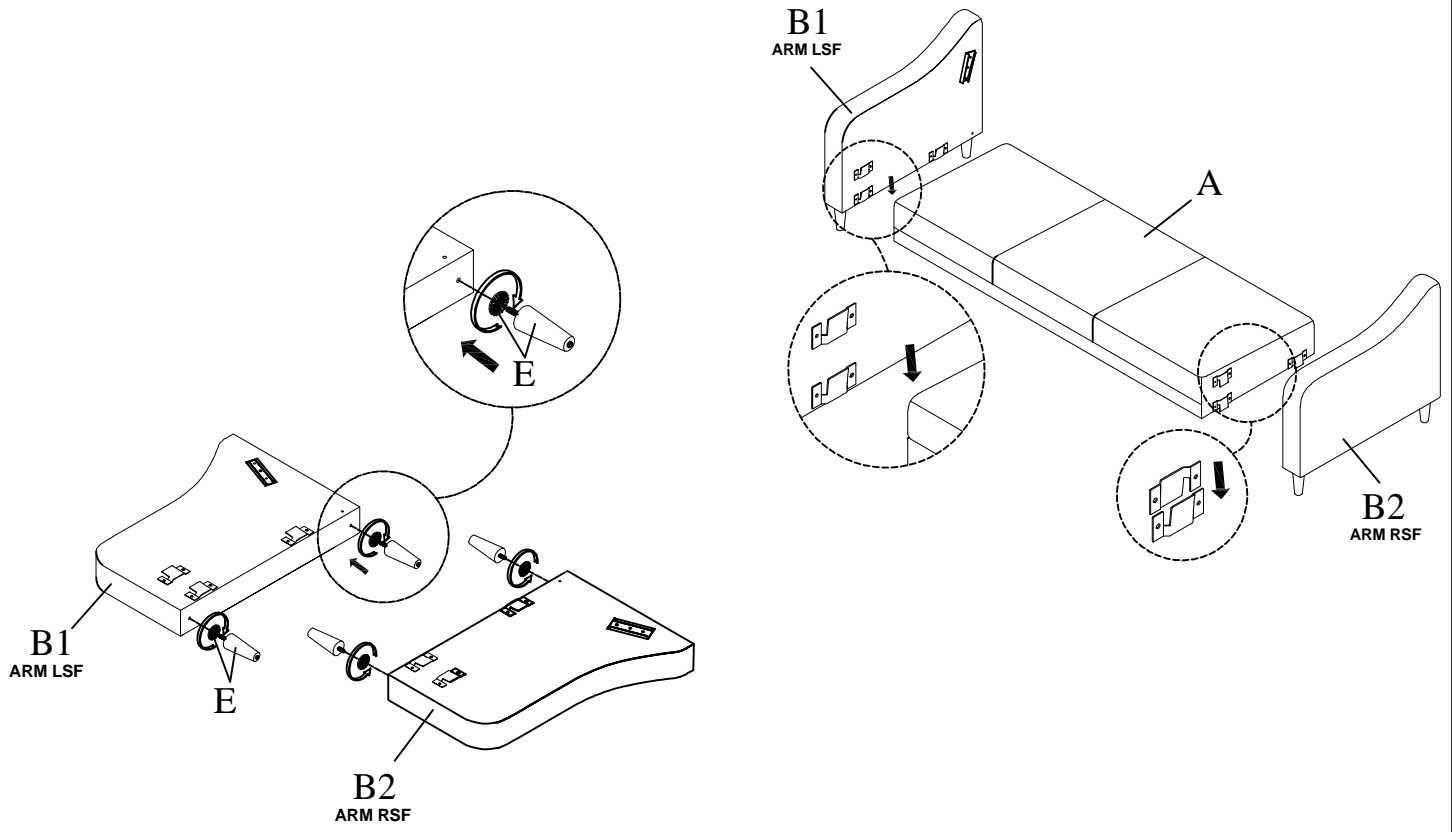

# Step #2

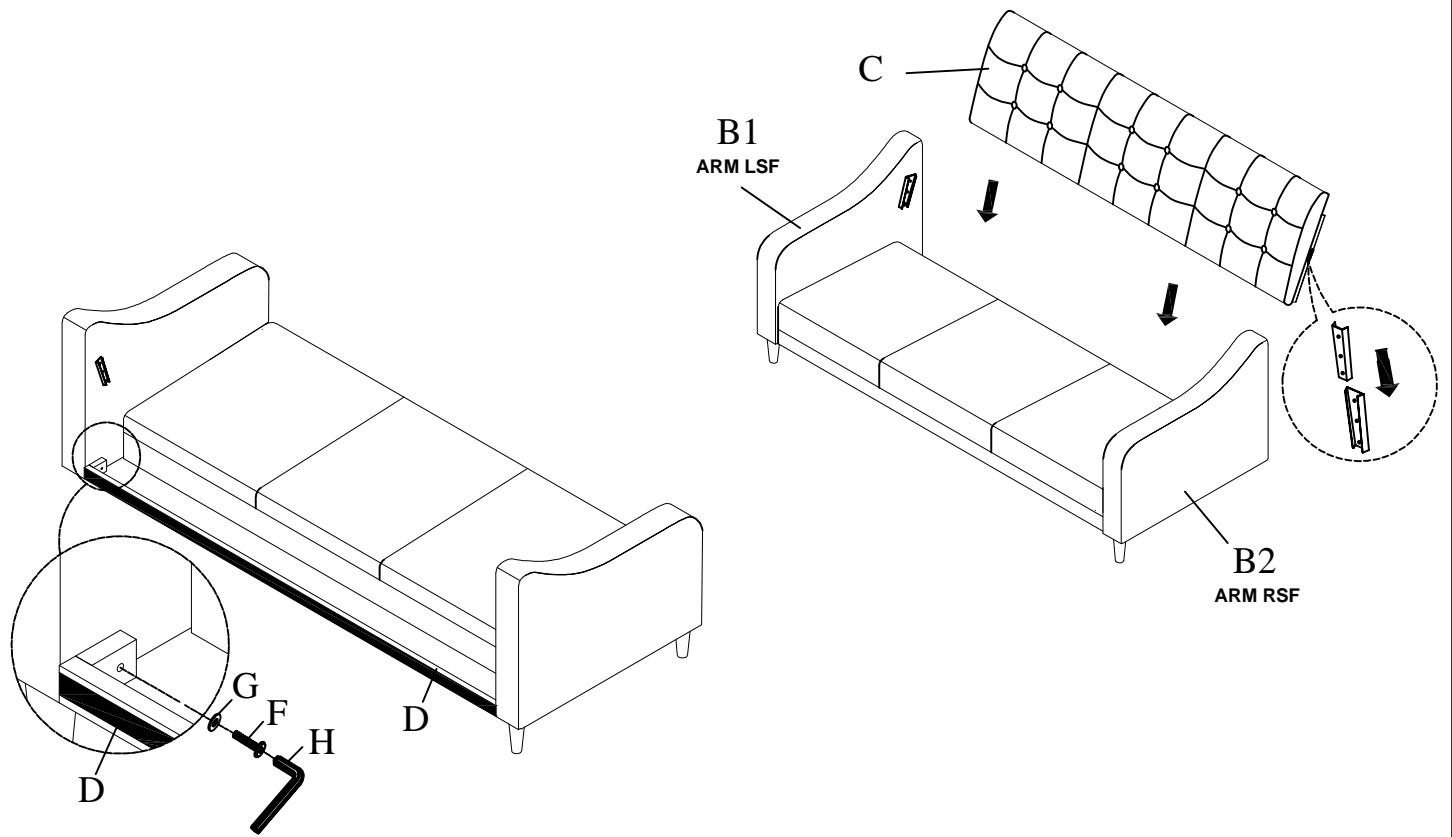



### Step #3

Assembly completed.

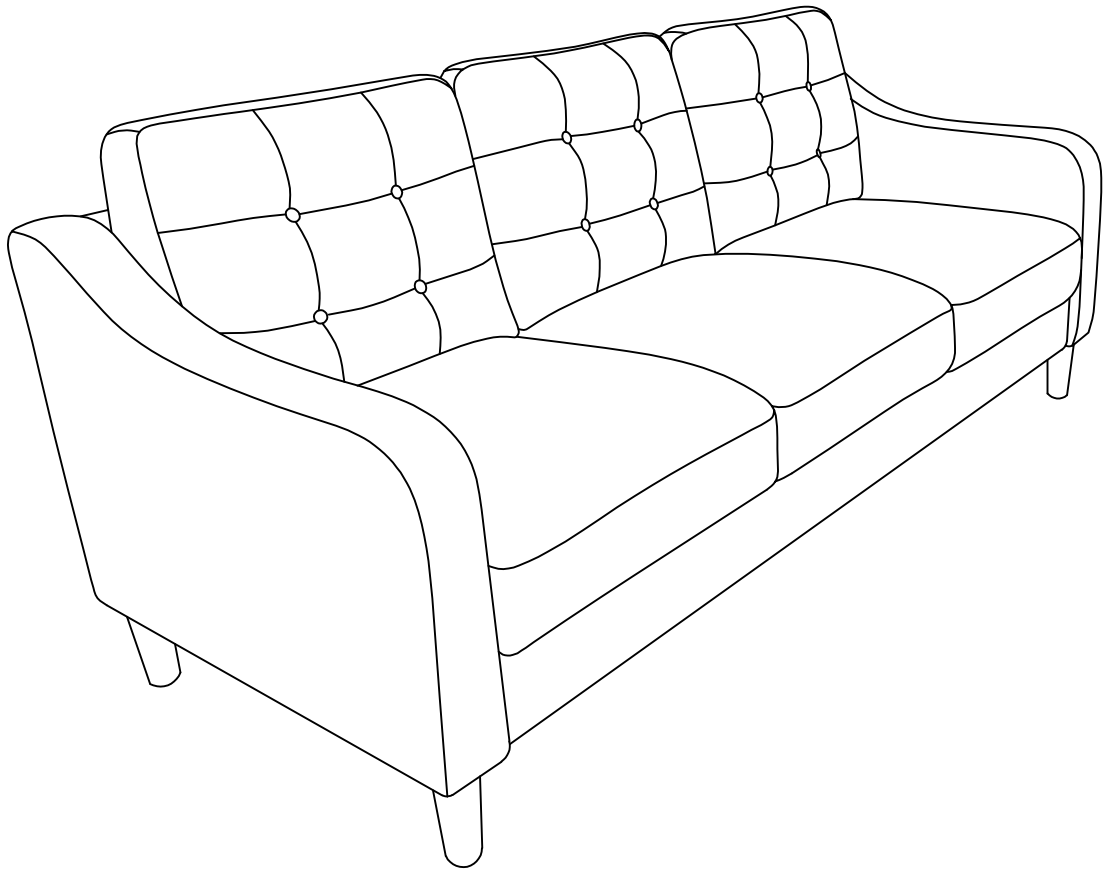

### Care Instruction for fabric Furniture:

In order to maintain the original appearance of your fabric Furniture, please follow below simple care procedures:

- Avoid exposing furniture directly to sunlight or heating and air conditioning outlets. Sunlight and/or exposure to heating and air conditioning outlets will fade/damage fabric. Do not place your fabric furniture too close to windows, radiators, or vents, and be sure to use windows, radiators, or vents.
- Vacuum or wipe with a soft cloth to remove dust.

Hardware may loosen over time. Periodically check to make sure all connection are tight, Re-tighten if necessary.



For items use on wooden floor, hard surfaces or carpets, it is recommended to Install protective pads under all legs and supports to avoid/prevent from damages/scratches and discoloration.