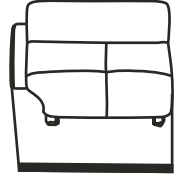
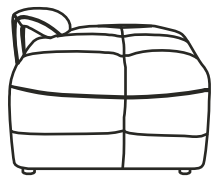

Assembly Instruction
ITEM NO: 194S9469DBR/
NVB-LC LSF Chaise, Push
Back Recliner

NOTE: Do not use power tools for assembly. Power tools increase the risk of over tightening which leads to splitting or cracking the wood.

COMPONENT LIST (CHAIR)

NO.	DRAWING	QTY	DESCRIPTION
A		1 PC	BACK REST
B		1 PC	SEAT

STEP#1

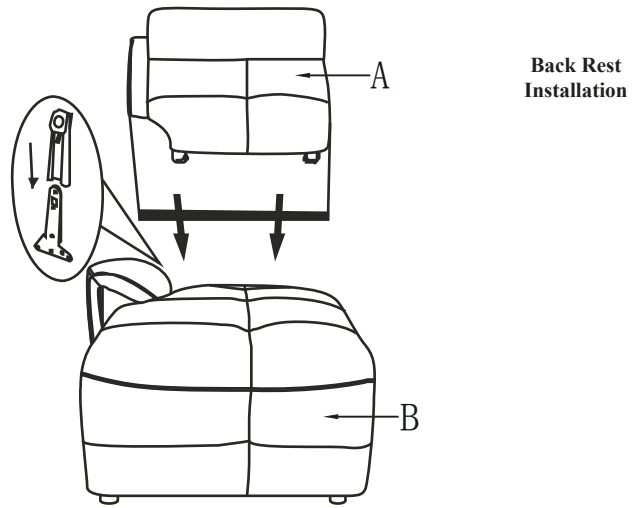

STEP#2

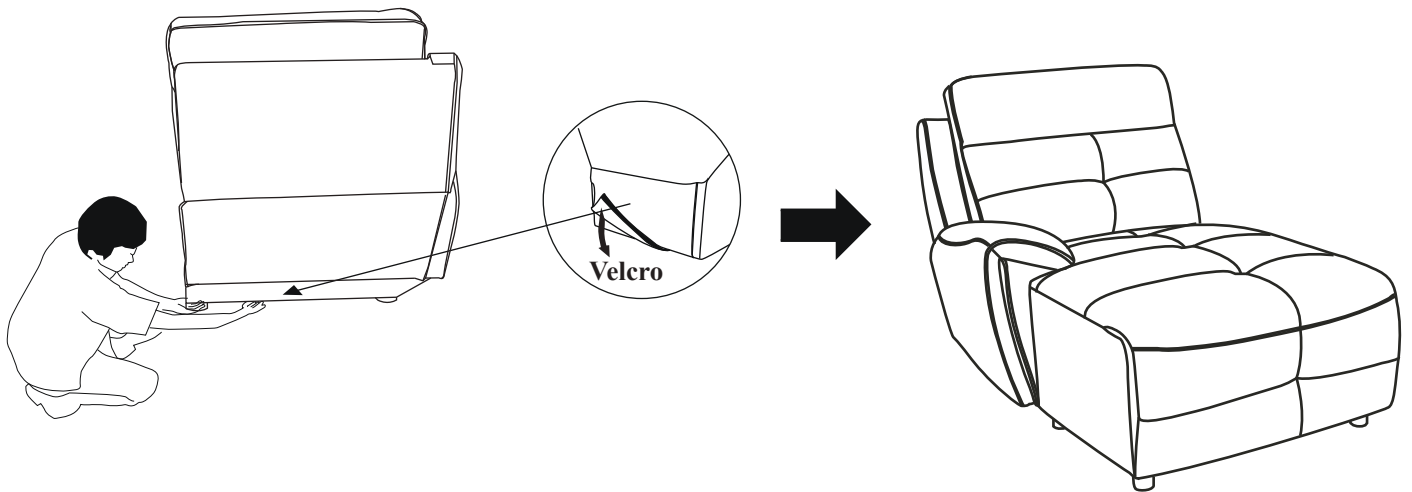

STEP#3

Push back rest to recline the back.

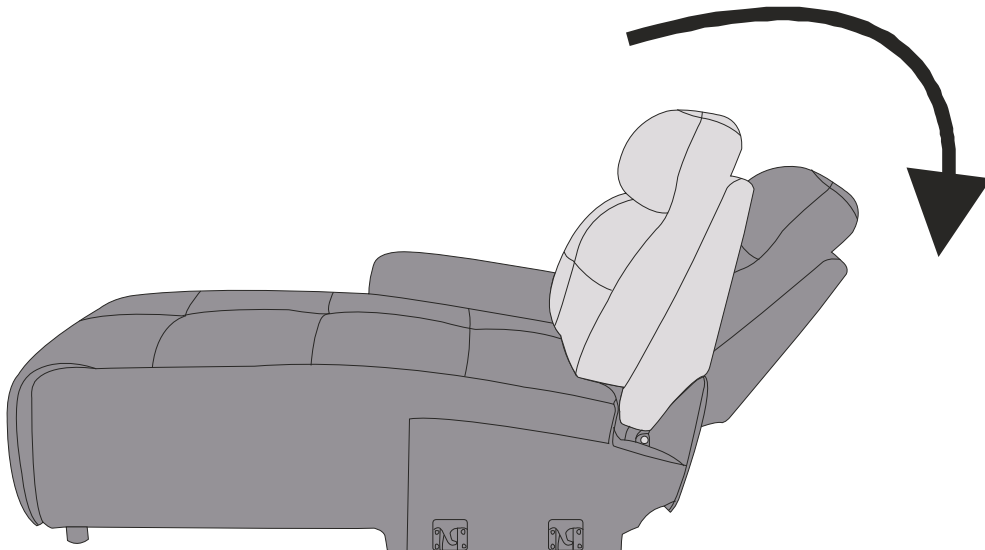

STEP#4

Connect each piece.

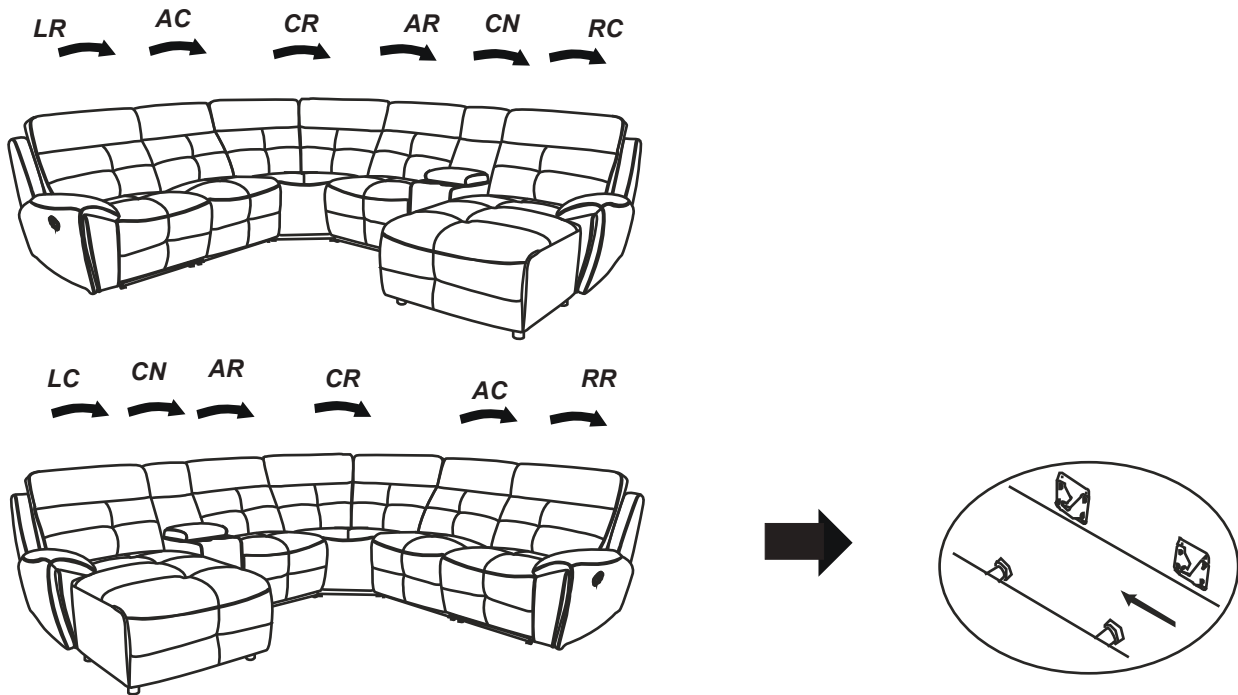

CARE INSTRUCTION FOR POLYESTER:

In order to maintain the original appearance of your polyester furniture, please follow below simple care procedure :

- Avoid exposing furniture directly to sunlight or heating and air conditioning outlets. Exposure to sunlight or heating and air conditioning outlets will fade/damage polyester.
 - Wipe gently with a damp soft cloth to remove dust, dirt and any grime build up.
- ⚠** It is recommended to install protective pads under all legs and supports to avoid damage or scratches when placing furniture on a wood floor or other hard surface, and to limit indentation and prevent discoloration if placing on carpet.

Assembly Instruction
ITEM NO: 194S9469DBR/
NVB-AC Armless Chair

NOTE: Do not use power tools for assembly. Power tools increase the risk of over tightening which leads to splitting or cracking the wood.

COMPONENT LIST (CHAIR)

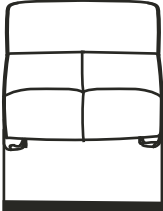
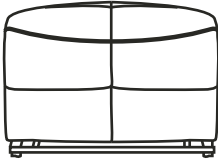
NO.	DRAWING	QTY	DESCRIPTION
A		1 PC	BACK REST
B		1 PC	SEAT

STEP#1

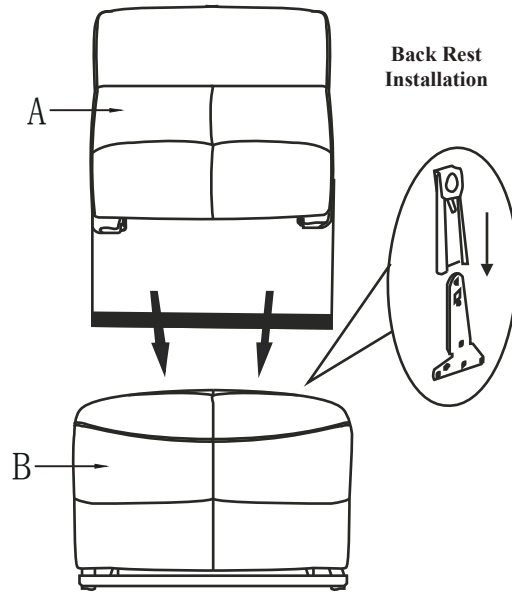

STEP#2

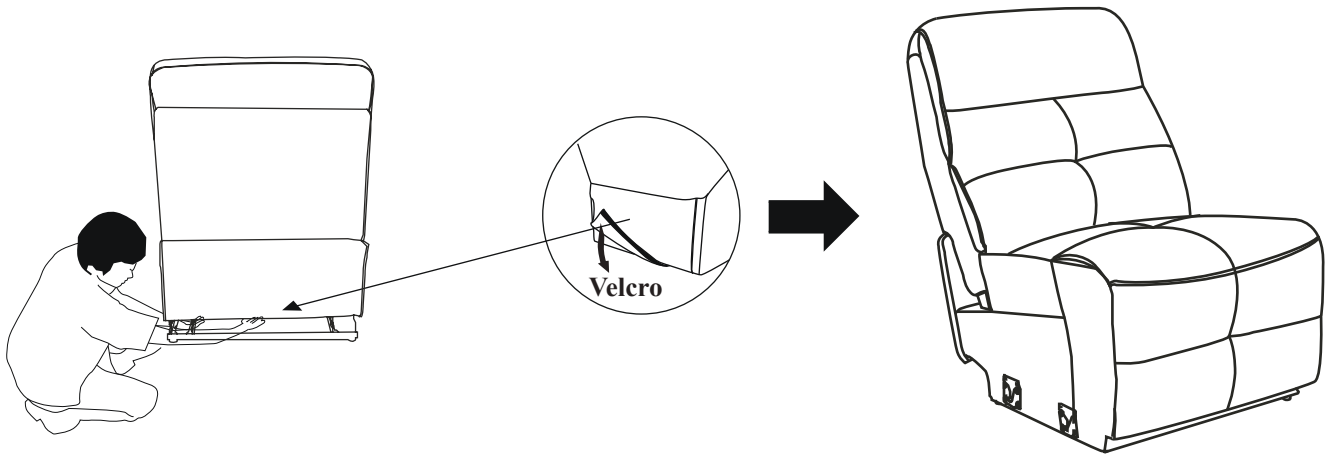

STEP#3

Connect each piece.

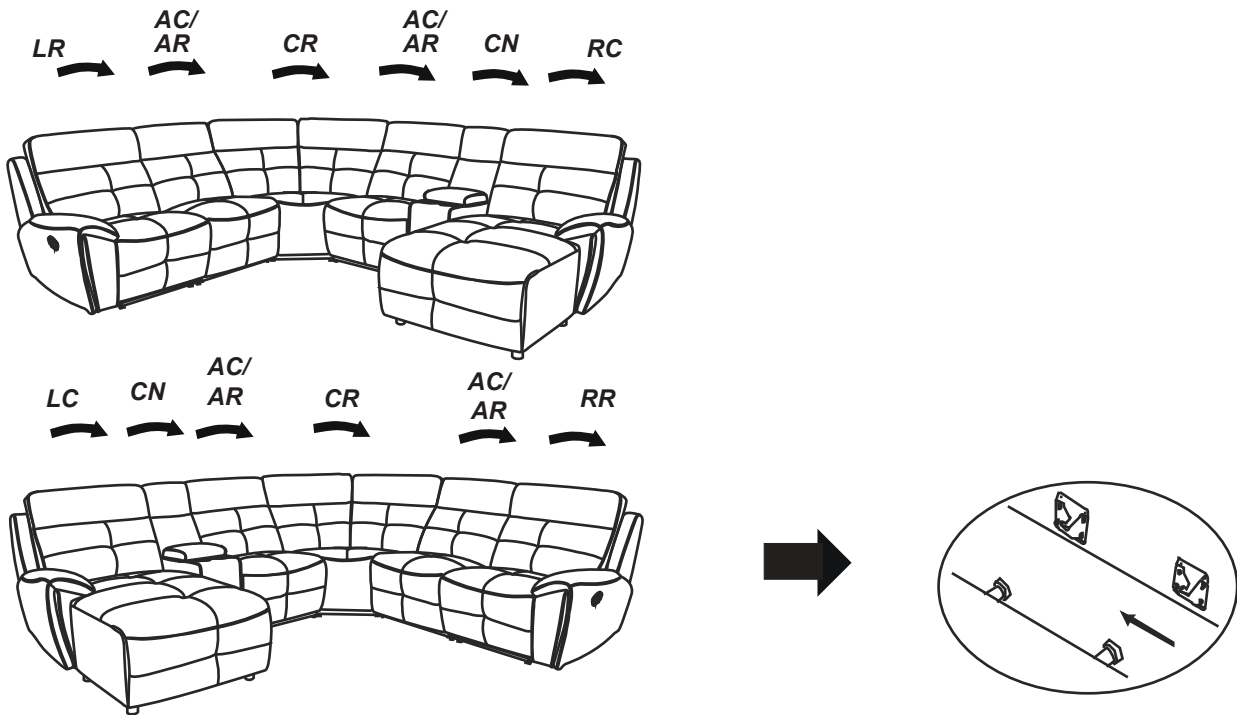

CARE INSTRUCTION FOR POLYESTER:



In order to maintain the original appearance of your polyester furniture, please follow below simple care procedure :

- Avoid exposing furniture directly to sunlight or heating and air conditioning outlets. Exposure to sunlight or heating and air conditioning outlets will fade/damage polyester.
- Wipe gently with a damp soft cloth to remove dust, dirt and any grime build up.

Assembly Instruction
ITEM NO: 194S9469DBR/
NVB-CN Console

NOTE: Do not use power tools for assembly. Power tools increase the risk of over tightening which leads to splitting or cracking the wood.

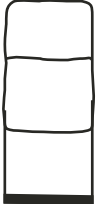
COMPONENT LIST (CHAIR)

NO.	DRAWING	QTY	DESCRIPTION
A		1 PC	BACK REST
B		1 PC	SEAT
C		3 PC	SCREW

STEP#1

Take out the console back from back of seat, then use 3 pcs screws connect console back and seat in specified holes, tighten by hands.

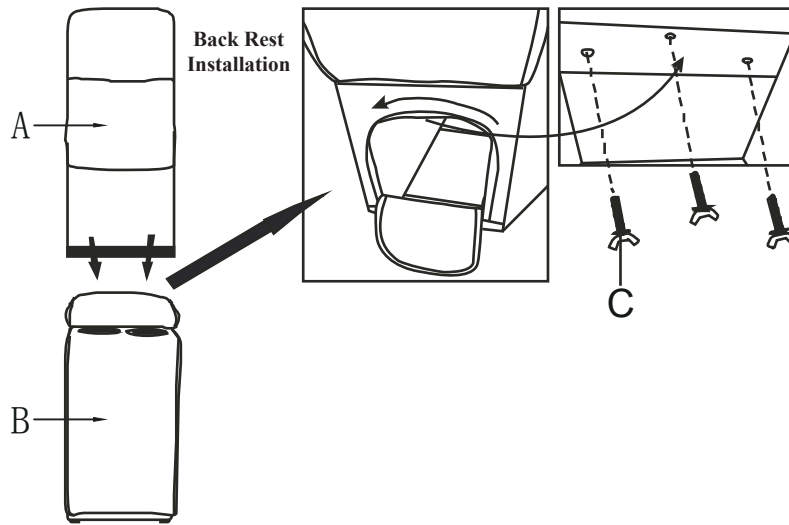

STEP#2

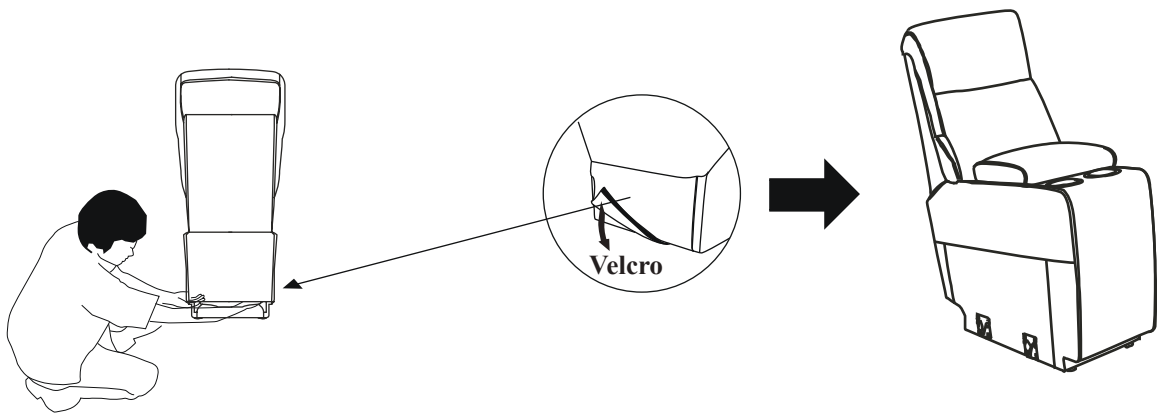

STEP#3

Connect each piece.

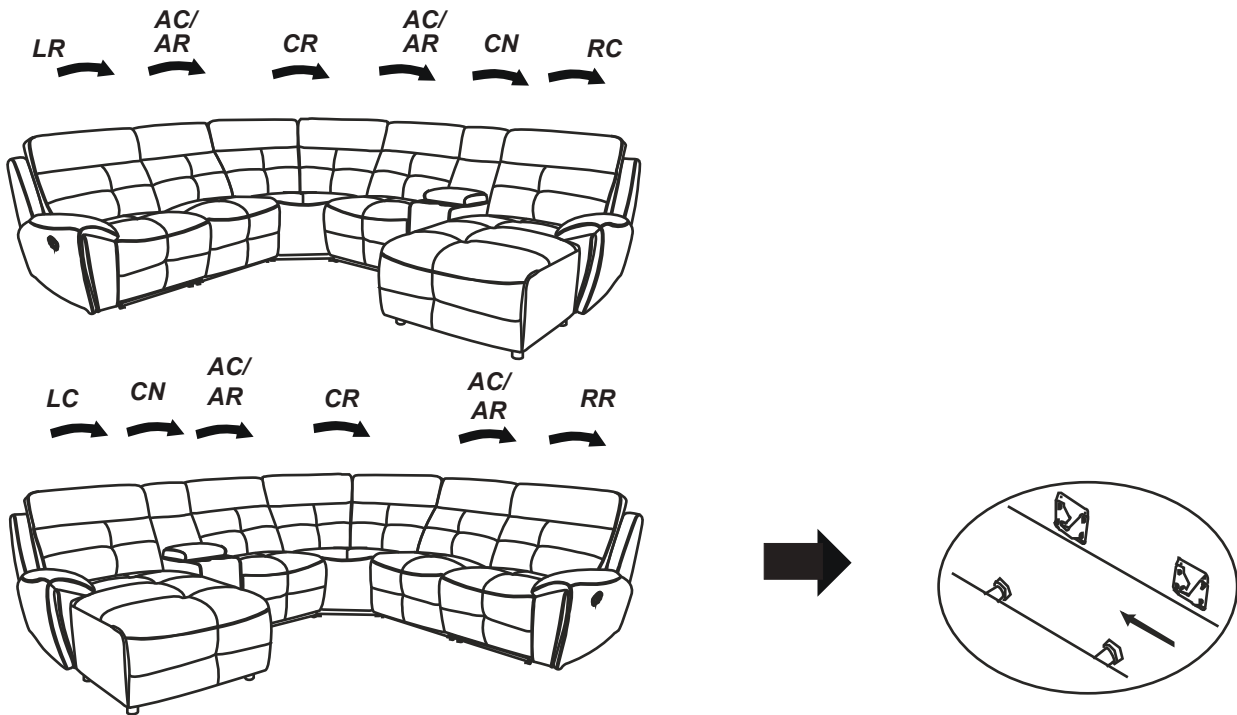

CARE INSTRUCTION FOR POLYESTER:



In order to maintain the original appearance of your polyester furniture, please follow below simple care procedure :

- Avoid exposing furniture directly to sunlight or heating and air conditioning outlets. Exposure to sunlight or heating and air conditioning outlets will fade/damage polyester.
- Wipe gently with a damp soft cloth to remove dust, dirt and any grime build up.

Assembly Instruction
ITEM NO: 194S9469DBR/NVB-CR
Corner Seat

NOTE: Do not use power tools for assembly. Power tools increase the risk of over tightening which leads to splitting or cracking the wood.

COMPONENT LIST (CHAIR)

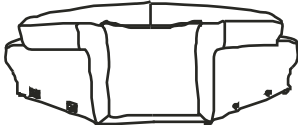
NO.	DRAWING	QTY	DESCRIPTION
A		1 PC	LSF BACK REST
B		1 PC	RSF BACK REST
C		1 PC	SEAT

STEP#1

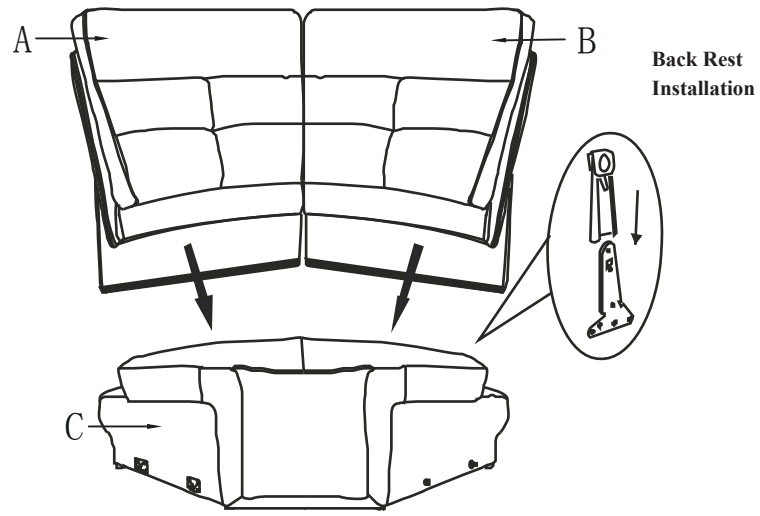

STEP#2

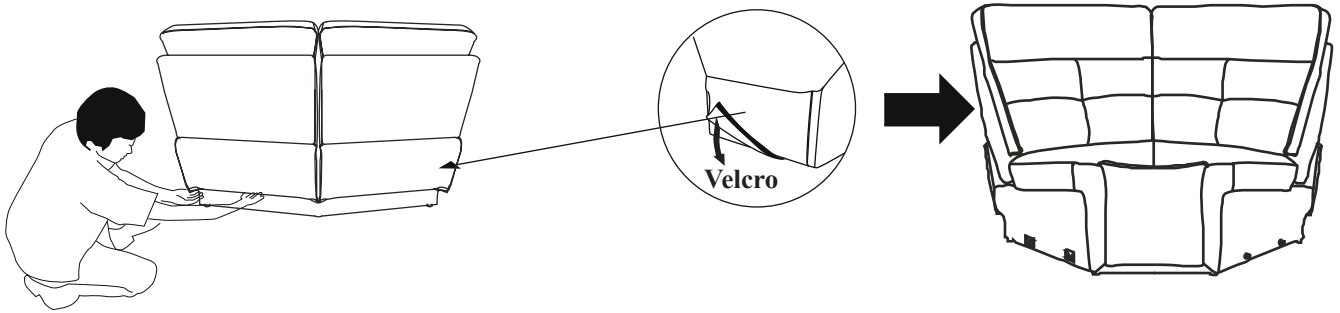

STEP#3

Connect each piece.

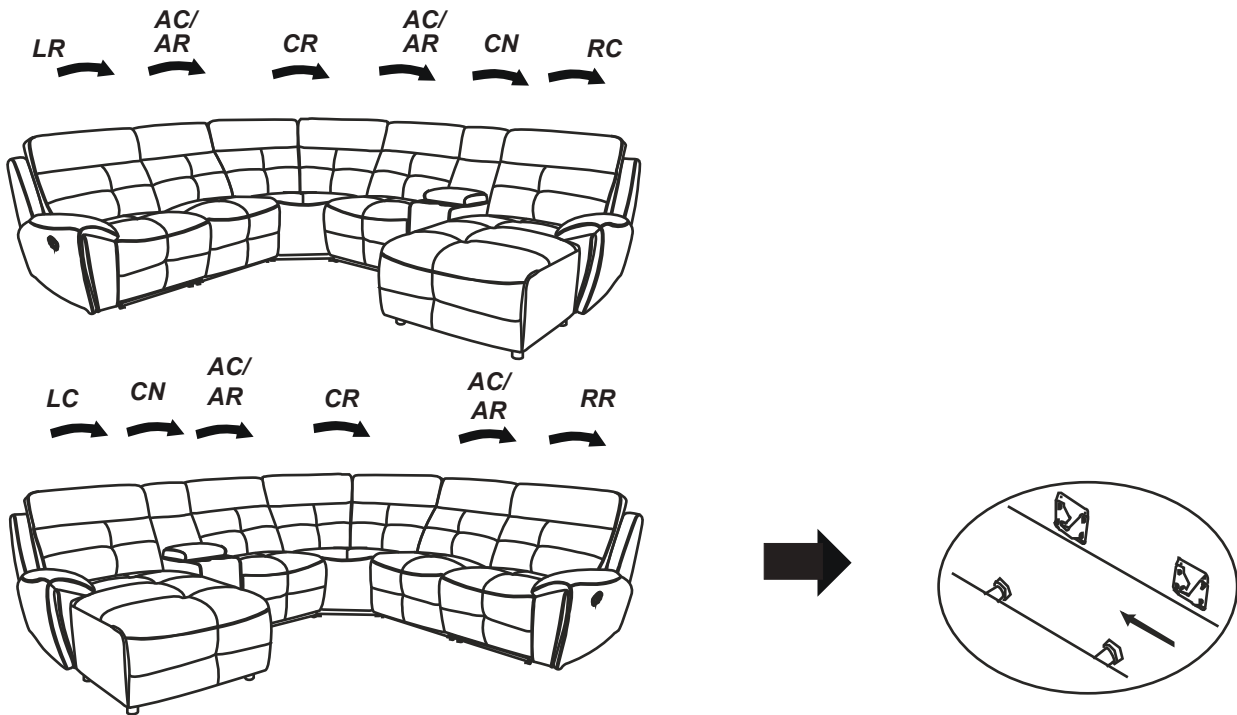

CARE INSTRUCTION FOR POLYESTER:

In order to maintain the original appearance of your polyester furniture, please follow below simple care procedure :

- Avoid exposing furniture directly to sunlight or heating and air conditioning outlets. Exposure to sunlight or heating and air conditioning outlets will fade/damage polyester.
- Wipe gently with a damp soft cloth to remove dust, dirt and any grime build up.

Assembly Instruction
ITEM NO.: 194S9469DBR/NVB-AR
Armless Reclining Chair

NOTE: Do not use power tools for assembly. Power tools increase the risk of over tightening which leads to splitting or cracking the wood.

COMPONENT LIST (CHAIR)

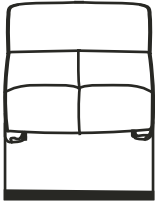
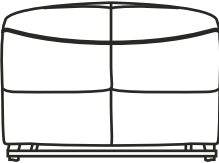
NO.	DRAWING	QTY	DESCRIPTION
A		1 PC	BACK REST
B		1 PC	SEAT

STEP#1

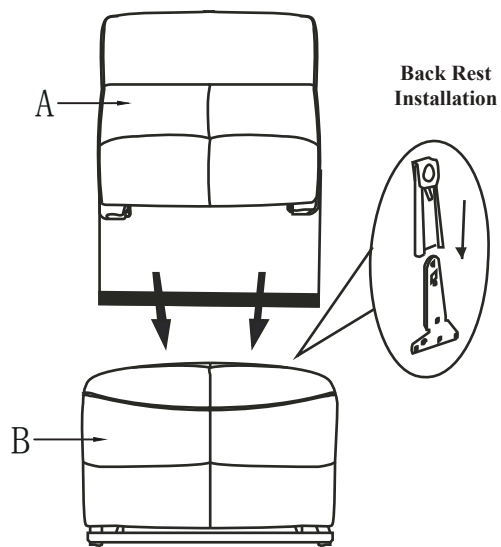

STEP#2

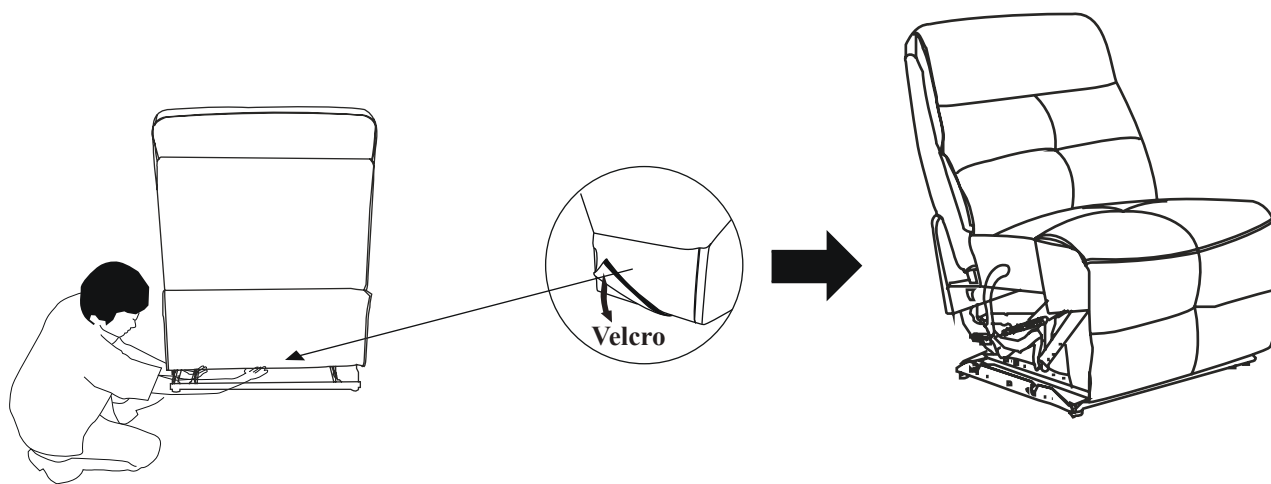

STEP#3

Use the handle to open the recliner.

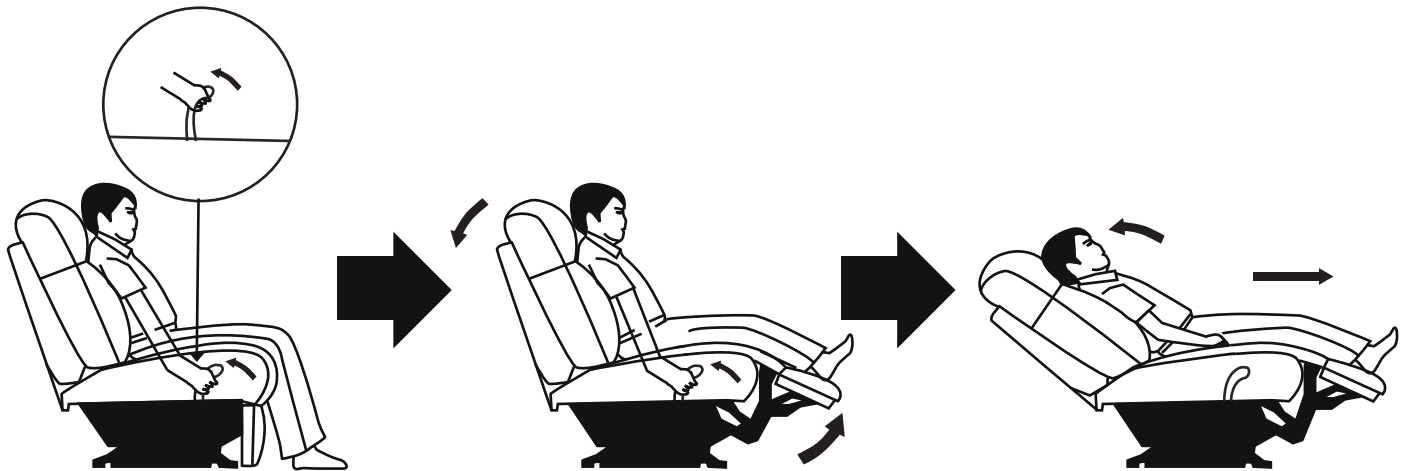

STEP#4

Connect each piece.

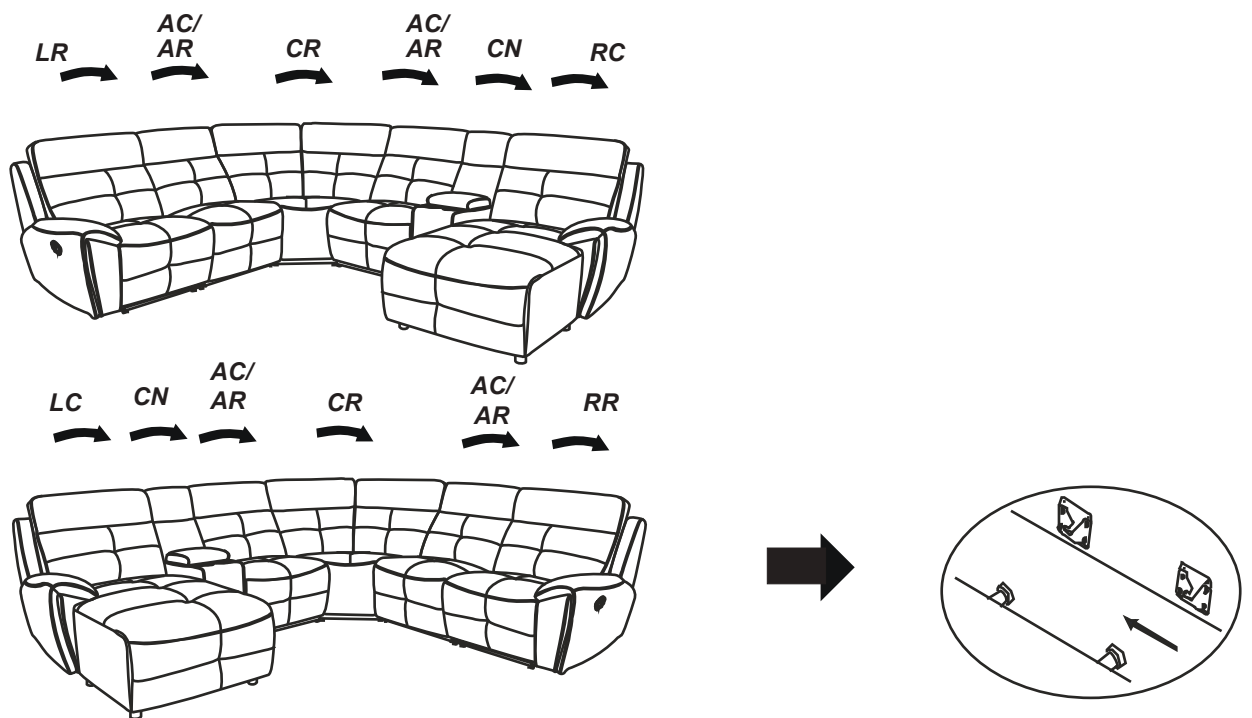

CARE INSTRUCTION FOR POLYESTER:

In order to maintain the original appearance of your polyester furniture, please follow below simple care procedure :

- Avoid exposing furniture directly to sunlight or heating and air conditioning outlets. Exposure to sunlight or heating and air conditioning outlets will fade/damage polyester.
- Wipe gently with a damp soft cloth to remove dust, dirt and any grime build up.

Assembly Instruction
ITEM NO: 194S9469DBR/
NVB-RR RSF Reclining Chair

NOTE: Do not use power tools for assembly. Power tools increase the risk of over tightening which leads to splitting or cracking the wood.

COMPONENT LIST (CHAIR)

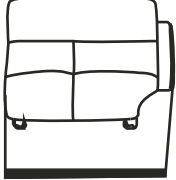
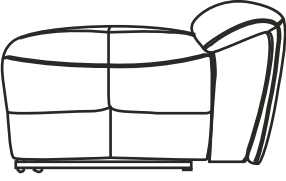
NO.	DRAWING	QTY	DESCRIPTION
A		1 PC	BACK REST
B		1 PC	SEAT

STEP#1

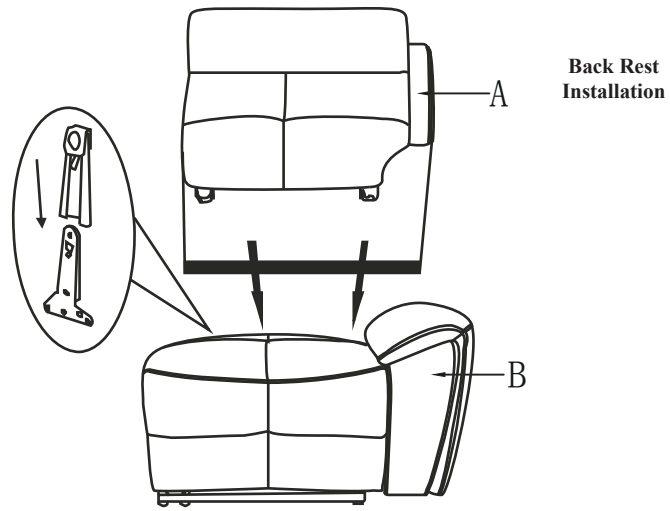

STEP#2

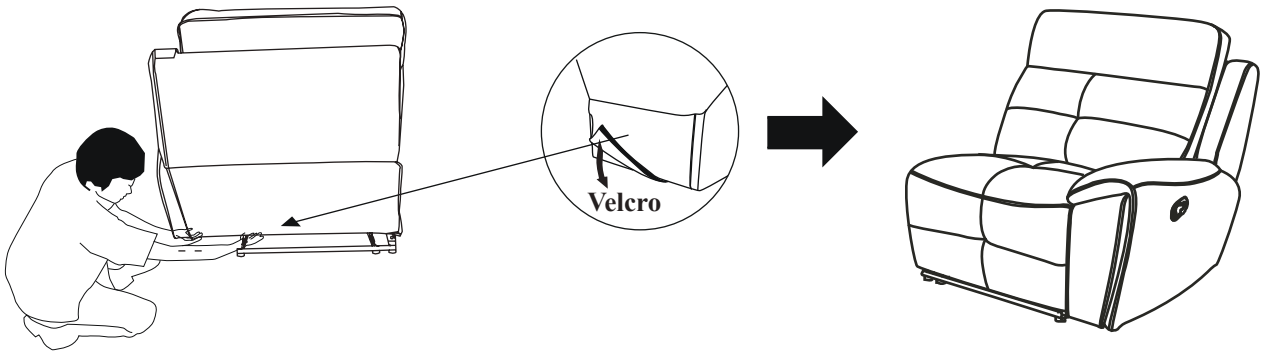

STEP#3

Connect each piece.

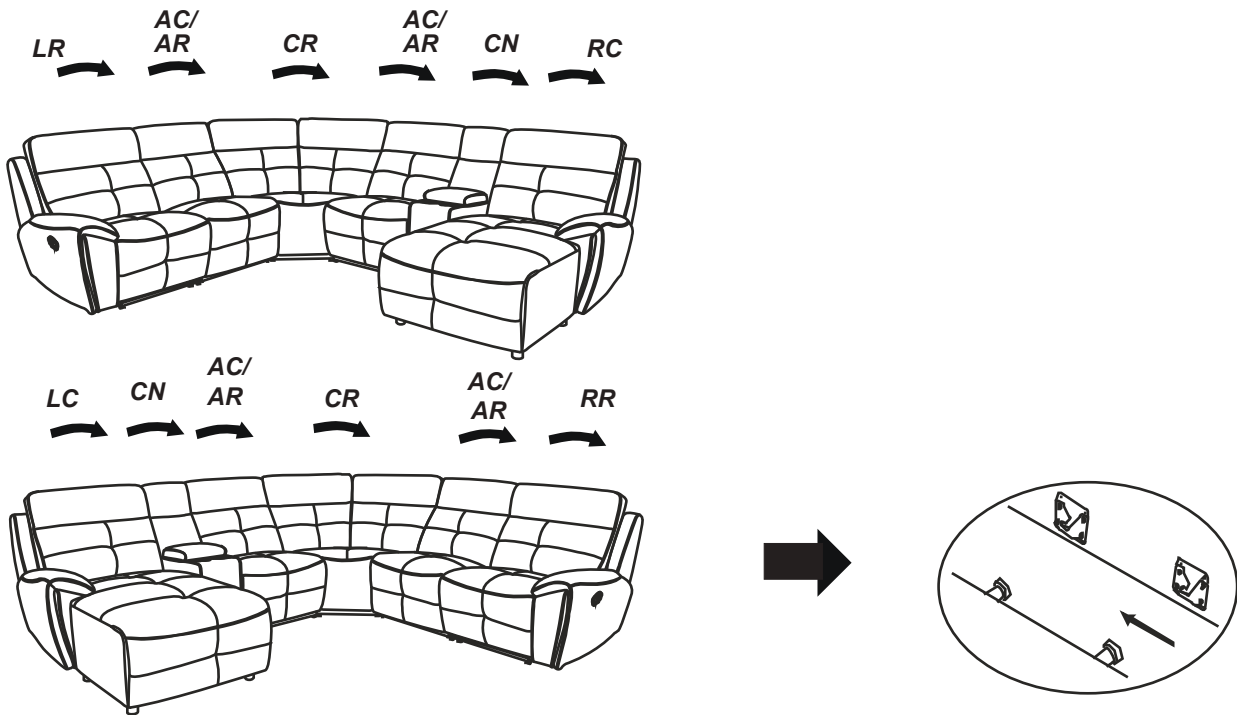

CARE INSTRUCTION FOR POLYESTER:

In order to maintain the original appearance of your polyester furniture, please follow below simple care procedure :

- Avoid exposing furniture directly to sunlight or heating and air conditioning outlets. Exposure to sunlight or heating and air conditioning outlets will fade/damage polyester.
- Wipe gently with a damp soft cloth to remove dust, dirt and any grime build up.