







ASSEMBLY INSTRUCTION
ITEM NO: 194S9417BUE/GRN/GRY-2
LOVE SEAT WITH 2 PILLOWS

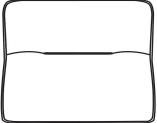

NOTE: Do not use power tools for assembly. The use of power tools increases the risk of over-tightening, which can result in wood splitting or cracking.

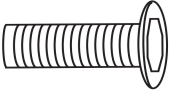
COMPONENT LIST

NO	DRAWING	QTY	DESCRIPTION
A		1	Love seat
B		2	Seat cushion
C		2	Back cushion
D		2	Pillow (18x18")
E		4	Metal legs (H: 8")
F		16	Bolt (ØM8x20mm)
G		1	Allen Key (ØM8)

Step1

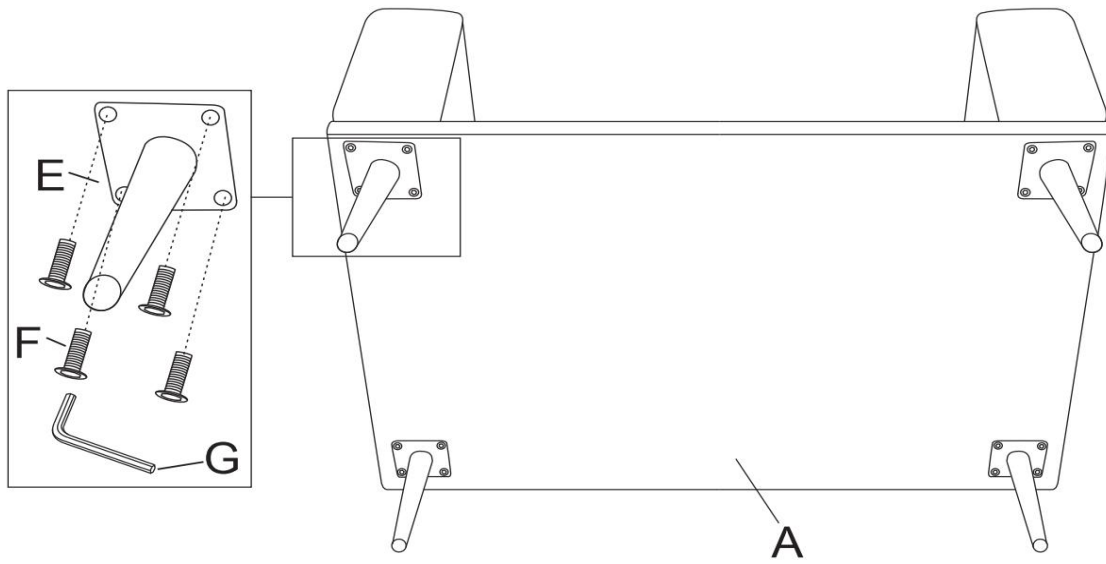

Step2

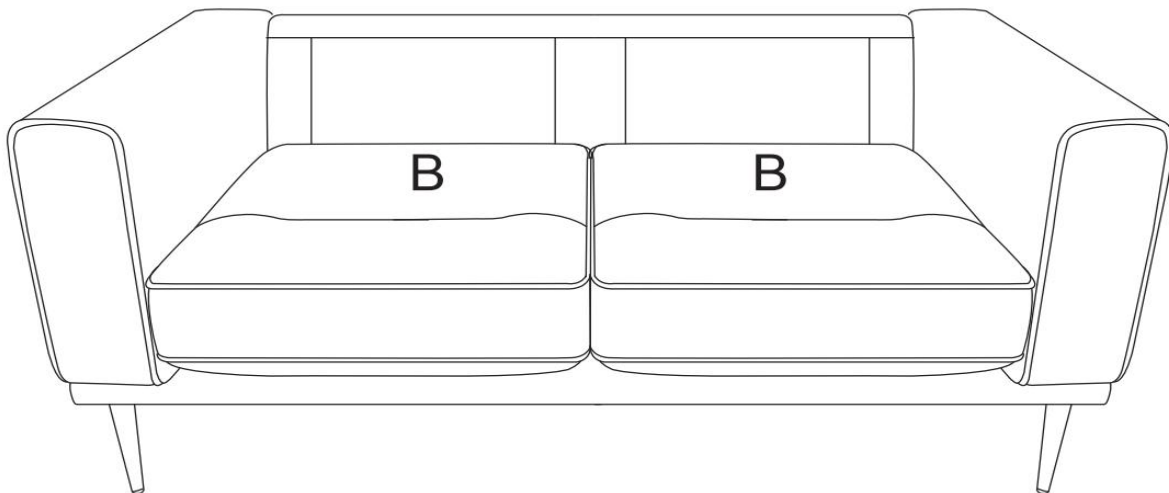

Step3

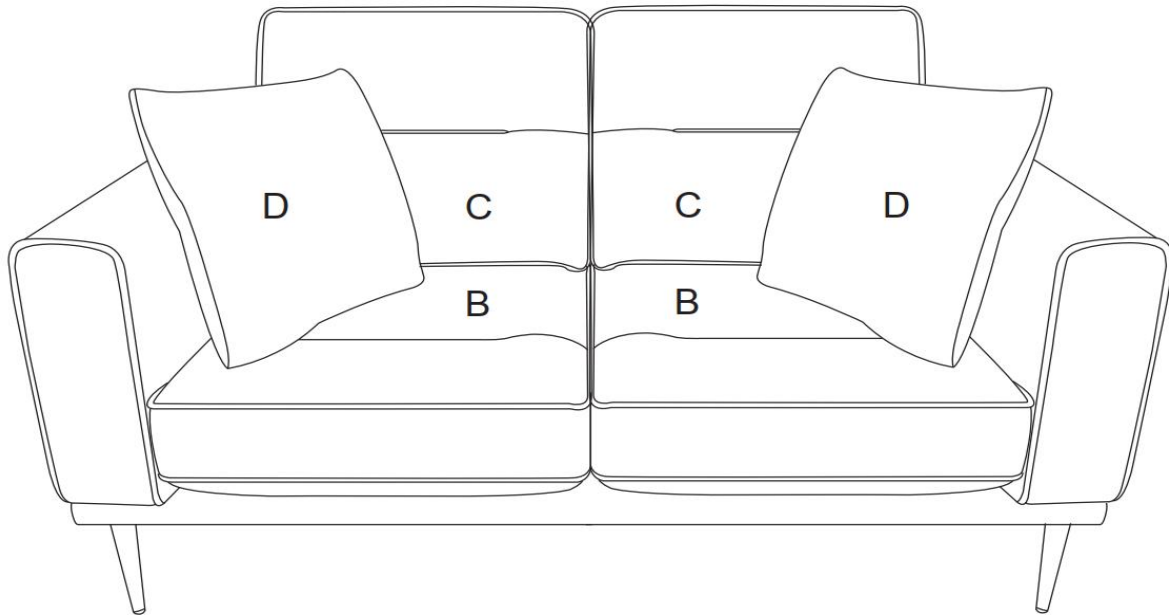

Care Instruction for Velvet Furniture.

In order to maintain the original appearance of your Velvet furniture, please follow below simple care procedures:

- Avoid exposing furniture directly to sunlight or heating and air conditioning outlets. Sunlight and/or exposure to heating and air conditioning outlets will fade/damage Velvet furniture.
- Do not place your upholstered furniture too close to windows, radiators, or vents and be sure to use window, radiators, or vents.
- Vacuum or wipe with a soft brush to remove dust.
- Hardware may loosen over time. Periodically check to make sure all connection are tight, Re-tighten if necessary.



For items used on wooden floor, hard surfaces or carpets, it is recommended to install protected pads under all legs supports to avoid/prevent from damages/ scratches discoloration.