

Assembly Instruction

ITEM NO.: 194S9407DG-3





Sofa

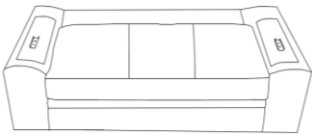
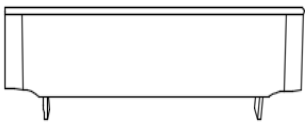
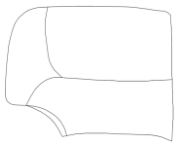

Legs and hardware are stored in the bubble bag and located underneath the seat, please take out for assembly.

Note: Do not use power tools for assembly. Power tools increase the risk of over tightening which lead to splitting or cracking the wood

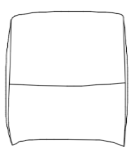
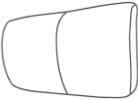
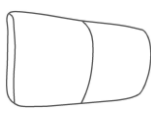
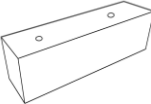
Component list .

Label	Picture	Description	QTY(pc)
A		Seat	1
B		Back Rest	1
C		LSF Back Cushion	1
D		RSF Back Cushion	1
E		Middle Back Cushion	1
F		LSF Arm Rest	1
G		RSF Arm Rest	1
H		Plastic Leg 7.08"*1.96"*1.96"	4
I		Screw φ0.15"*1.96"	8

Step #1

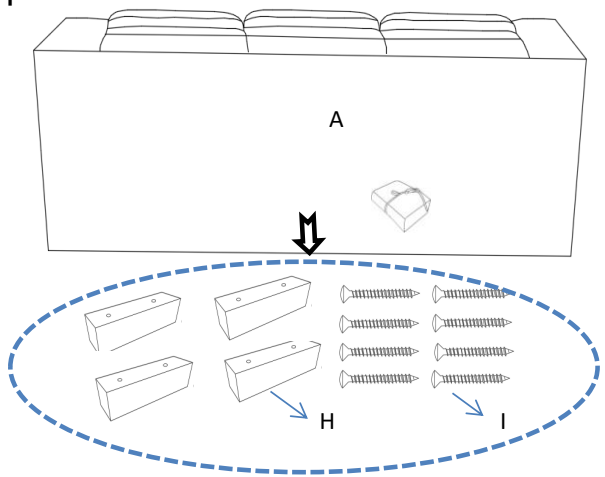

Step #2

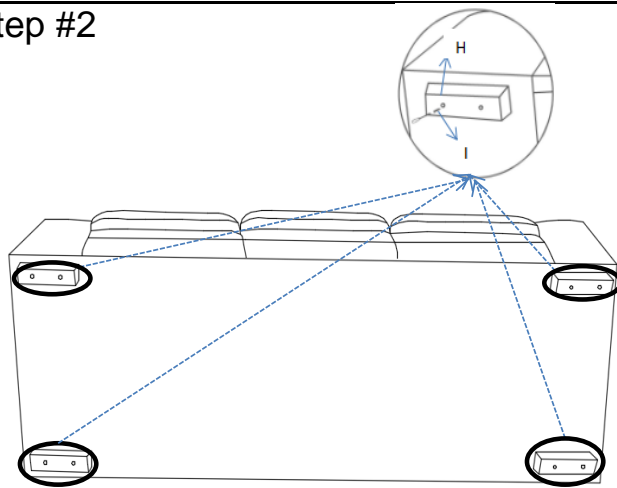

Step #3

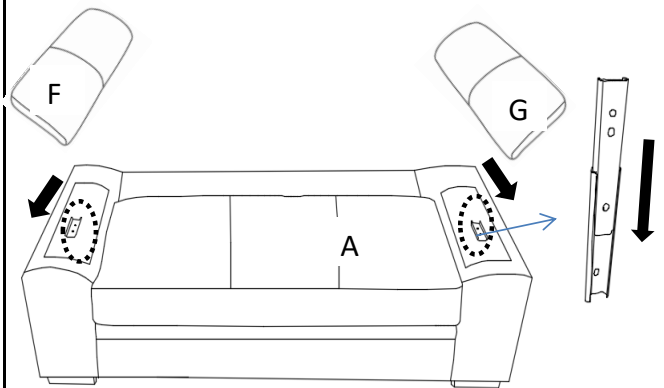

Step #4

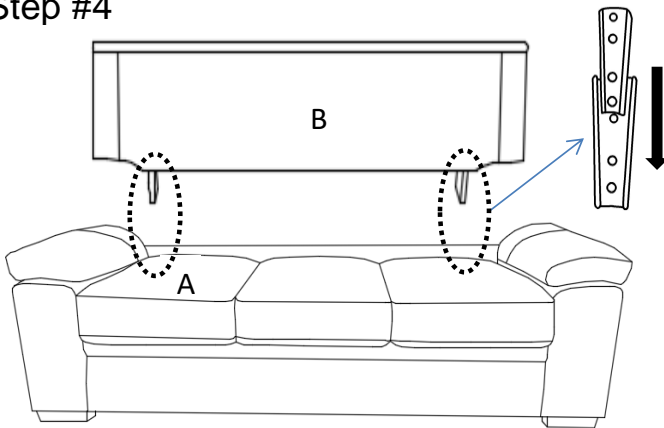

Step #5

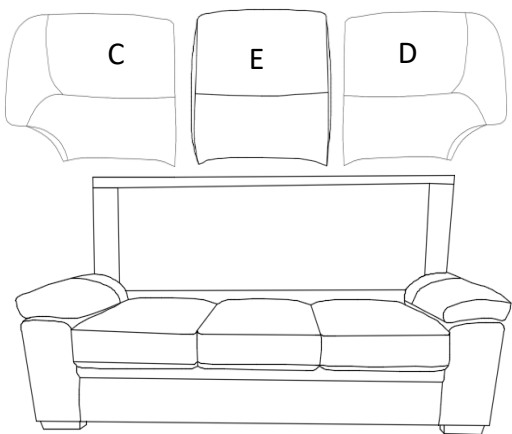

Step #6

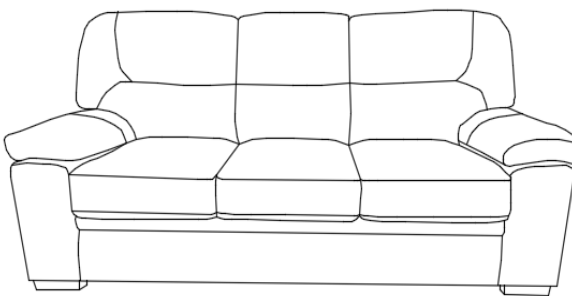

Care Instruction for Fabric Furniture:

In order to maintain the original appearance of your Polished Microfiber furniture, please follow below simple care proceures:

- Avoid exposing furniture directly to sunlight or heating and air conditioning outlets. Sunlight and or exposure to heating and air conditioning outlets will fade/damage fabric.
- Vacuum or wipe with a soft cloth to remove dust.



For item use on wooden floor, hard surfaces or carpets, it is recommended to install protective pads under all legs and supports to avoid/prevent from damages/scratches and discoloration.