

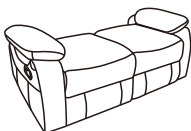

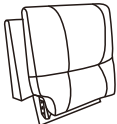
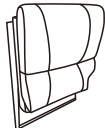

ASSEMBLY INSTRUCTION
DOUBLE RECLINING LOVE SEAT

The Metal pin are all wrapped together and placed on the back of the armrest

NOTE: Do not use power tools for assembly. Power tools increase the risk of over tightening which leads to splitting or cracking the wood.

COMPONENT LIST (LOVE SEAT)

NO.	DRAWING	QTY	DESCRIPTION
A		1	SEAT
B		1	LSF BACK REST
C		1	RSF BACK REST
D		1	LSF ARMREST
E		1	RSF ARMREST
F		4	METAL PIN

STEP# 1

Insert metal pins (F) to the pre-drilled holes on both arms, turn clockwise to tighten it. Attach and insert both arms(D & E) onto the handrail, push to the end and make sure the metal pins is locked in place properly.

Step#2

Attach LSF Back Rest (B) and RSF Back Rest (C) to the Seat(A)

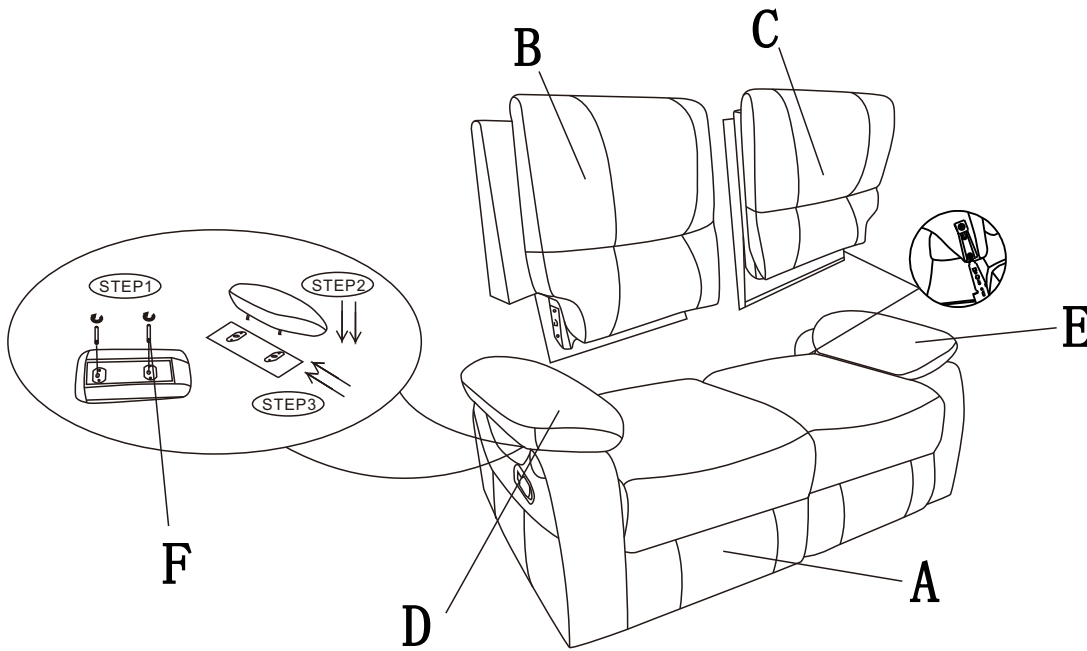

STEP#3 Completed

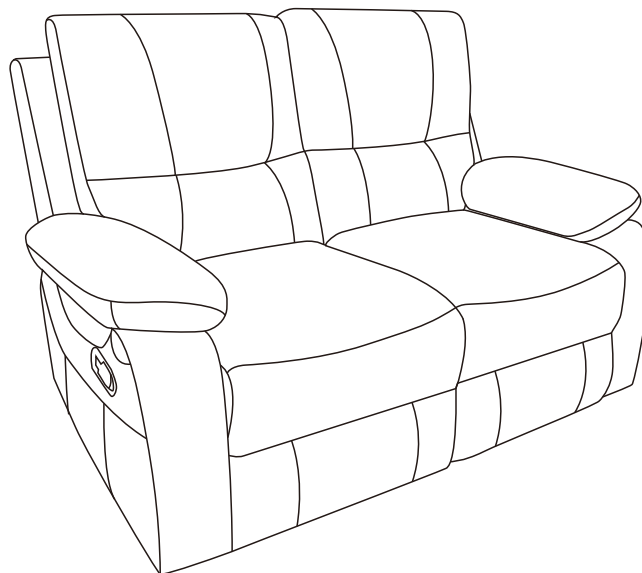

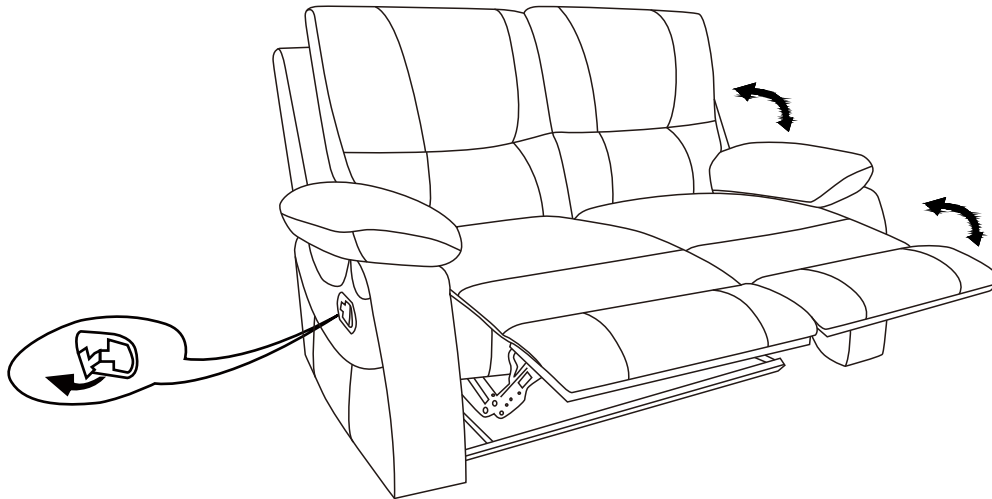

Care Instruction for PU Furniture.

In order to maintain the original appearance of your PU furniture, please follow below simple care procedures:

- Avoid exposing furniture directly to sunlight or heating and air conditioning outlets. Sunlight and/or exposure to heating and air conditioning outlets will fade/damage PU.
- Do not place your upholstered furniture too close to windows, radiators, or vents and be sure to use window, radiators, or vents.
- Vacuum or wipe with a soft brush to remove dust.



- For items used on wooden floor, hard surfaces or carpets, it is recommended to install protective pads
- under all legs supports to avoid/prevent from damages/scratches discoloration.





ASSEMBLY INSTRUCTION

DOUBLE RECLINING SOFA

The Metal pin are all wrapped together and placed on the back of the armrest

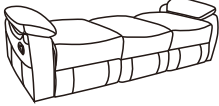
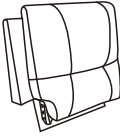
NOTE: Do not use power tools for assembly. Power tools increase the risk of over tightening which leads to splitting or cracking the wood.

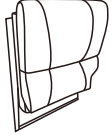
COMPONENT LIST (SOFA)

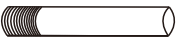
NO.	DRAWING	QTY	DESCRIPTION
A		1	SEAT
B		1	LSF BACK REST
C		1	MIDDLE BACK REST
D		1	RSF BACK REST
E		1	LSF ARMREST
F		1	RSF ARMREST
G		4	METAL PIN

STEP# 1

Insert metal pins (G) to the pre-drilled holes on both arms, turn clockwise to tighten it. Attach and insert both arms(E & F) onto the handrail, push to the end and make sure the metal pins is locked in place properly.

Step#2

Attach LSF Back Rest (B) and RSF Back Rest (D) and Middle Back Rest(C) to the Seat(A)

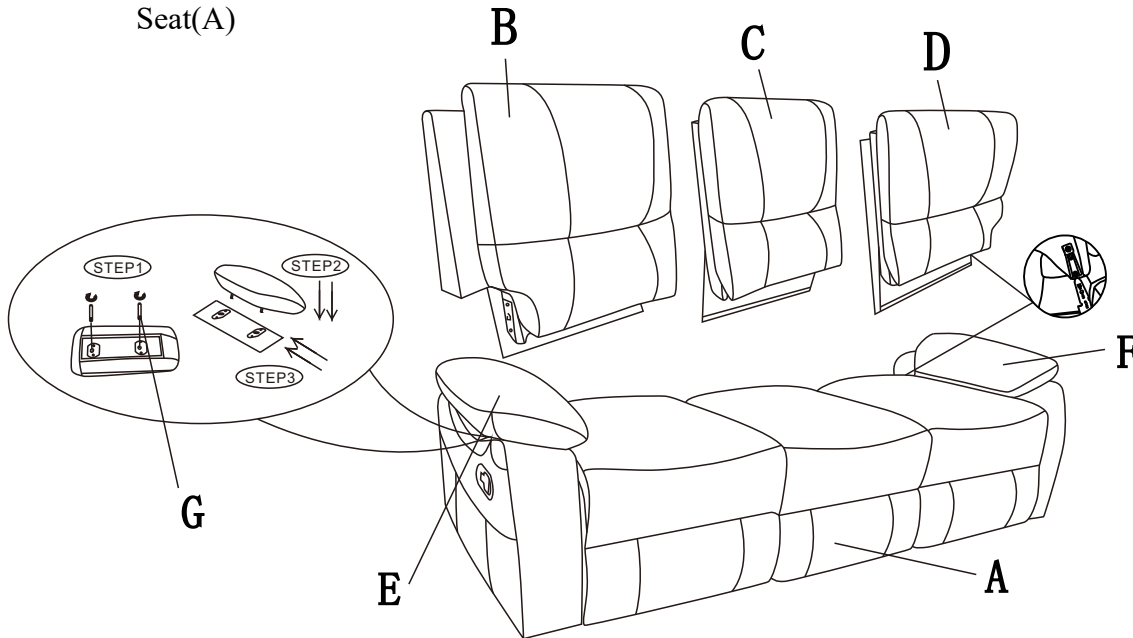

STEP#2 Completed

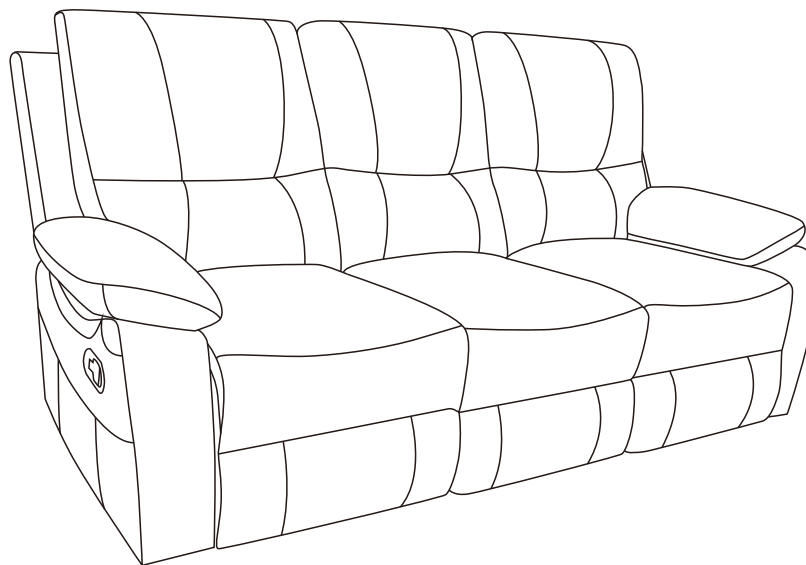

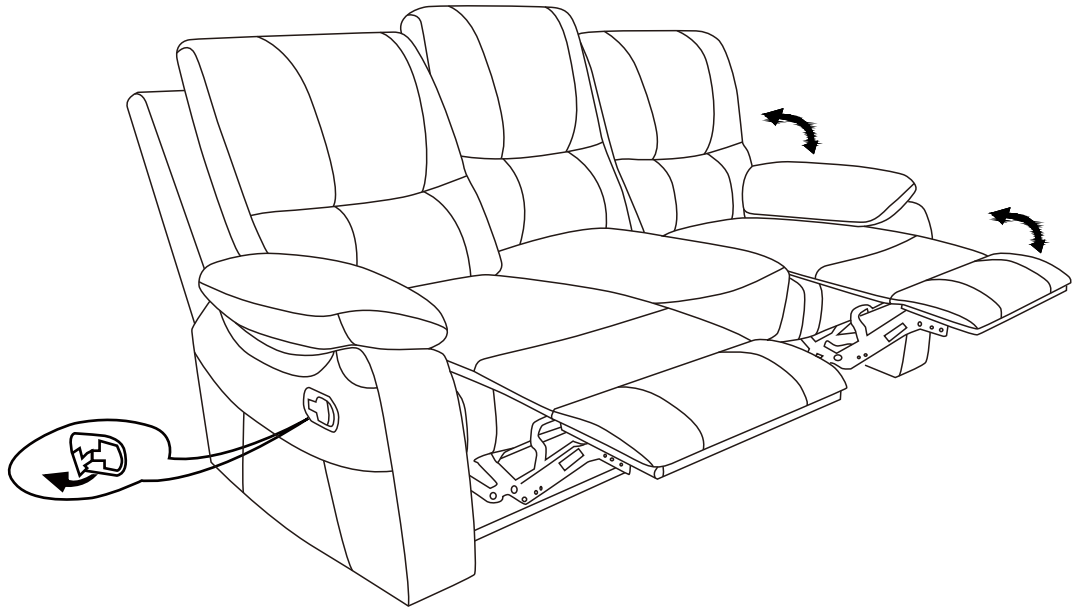

Care Instruction for PU Furniture

In order to maintain the original appearance of your PU furniture, please follow below simple care procedures:

- Avoid exposing furniture directly to sunlight or heating and air conditioning outlets. Sunlight and/or exposure to heating and air conditioning outlets will fade/damage PU.
- Do not place your upholstered furniture too close to windows, radiators, or vents and be sure to use window, radiators, or vents.
- Vacuum or wipe with a soft brush to remove dust.



For items used on wooden floor, hard surfaces or carpets, it is recommended to install protective pads under all legs supports to avoid/prevent from damages/scratches discoloration.