











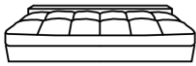

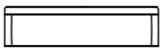
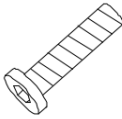
ASSEMBLY INSTRUCTION

ITEM NO: 194S9340BU/GY/TP-3

SOFA

NOTE: Do not use power tools for assembly. Power tools increase the risk of over tightening which lead to splitting or cracking the wood.

COMPONENT LIST

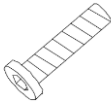
NO.	DRAWING	QTY	DESCRIPTION	NO.	DRAWING	QTY	DESCRIPTION
A		1	SEAT	H		1	WASHER
B		1	BACK REST	I		4	BOLT (M8*20)
C		1	LSF ARM REST	J		2	BOLT
D		1	RSF ARM REST	K		1	SUPPORT BAR
E		2	BACK COUSHION	L		2	WASHER
F		4	WOODEN LEG (H5.25")	M		1	ALLEN KEY
G		1	MIDDLE LEG (H5")	N		16	BOLT (M6*20)

Please follow the drawings below to assemble the item.

Wooden legs are stored in the box on the seat, please take out for assembly.

Step 1.

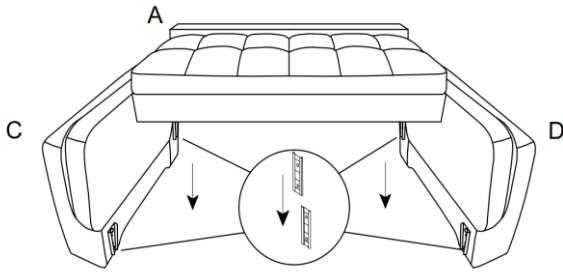

Step 2.

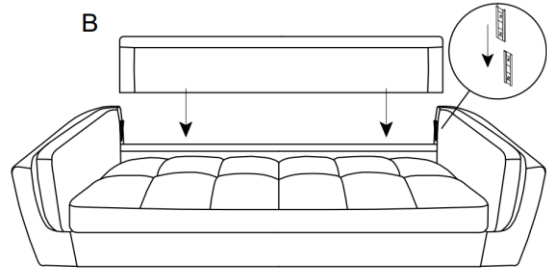

Step 3.

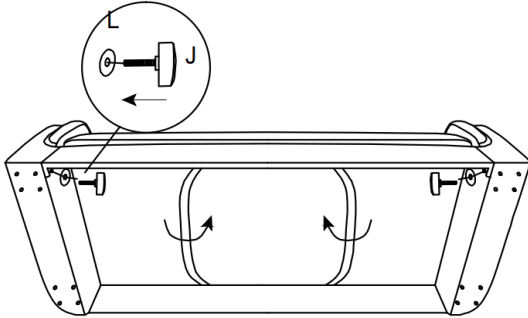

Step 4.

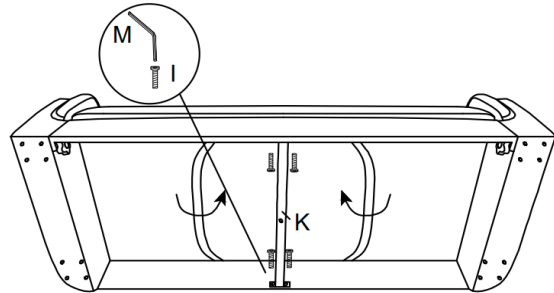

Step 5.

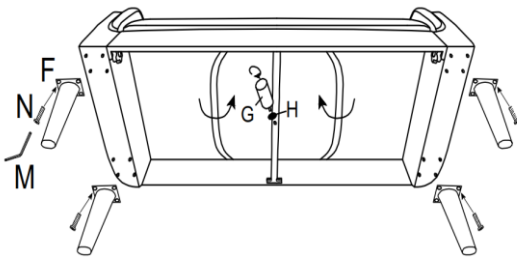

Step 6.

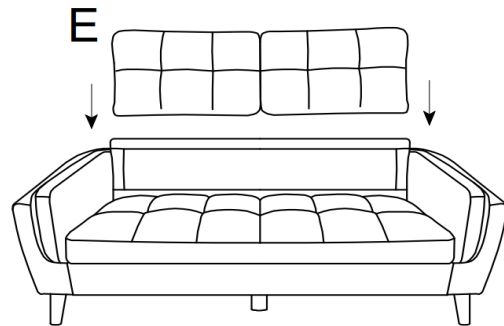

Step 7.

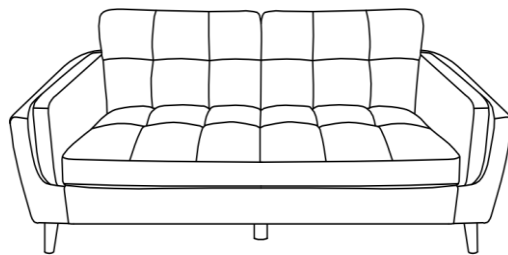

CARE INSTRUCTION FOR 100% POLYESTER FURNITURE

In order to maintain the original appearance of your 100% polyester furniture, please follow below care procedures:

- **Avoid exposing furniture directly to sunlight or heating and air conditioning outlets. Exposure to sunlight or heating and air conditioning outlets will fade/damage 100% polyester. Do not place your upholstered furniture too close to windows, radiators, or vents, and be sure to use window treatments to block the sun's rays.**
- **Wipe with a soft brush to remove dust.**



For items use on wooden floor, hard surfaces or carpets, it is recommended to install protective pads under all legs and supports to avoid/prevent from damages/scratches and discoloration