

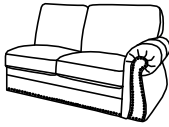



ASSEMBLY INSTRUCTION
ITEM NO: 194S9289DB-2R
RSF 2-SEATER

LEGS AND HARDWARE ARE STORED IN THE BOTTOM OF THE SEAT, PLEASE TAKE OUT FOR ASSEMBLY.

NO.	PARTS LIST	QTY	DESCRIPTION
A		1	RSF 2-SEATER

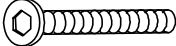
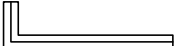
NO.	HARDWARE LIST	QTY	DESCRIPTION
B	 165*165*80mm	2	WOODEN LEGS
C	 M8*75mm	4	BOLT
D	 M5*100*38mm	1	ALLEN KEY
E	 H80mm	2	PLASTIC LEGS

ASSEMBLY INSTRUCTION
ITEM NO: 194S9289DB-2R
RSF 2-SEATER

STEP # 1

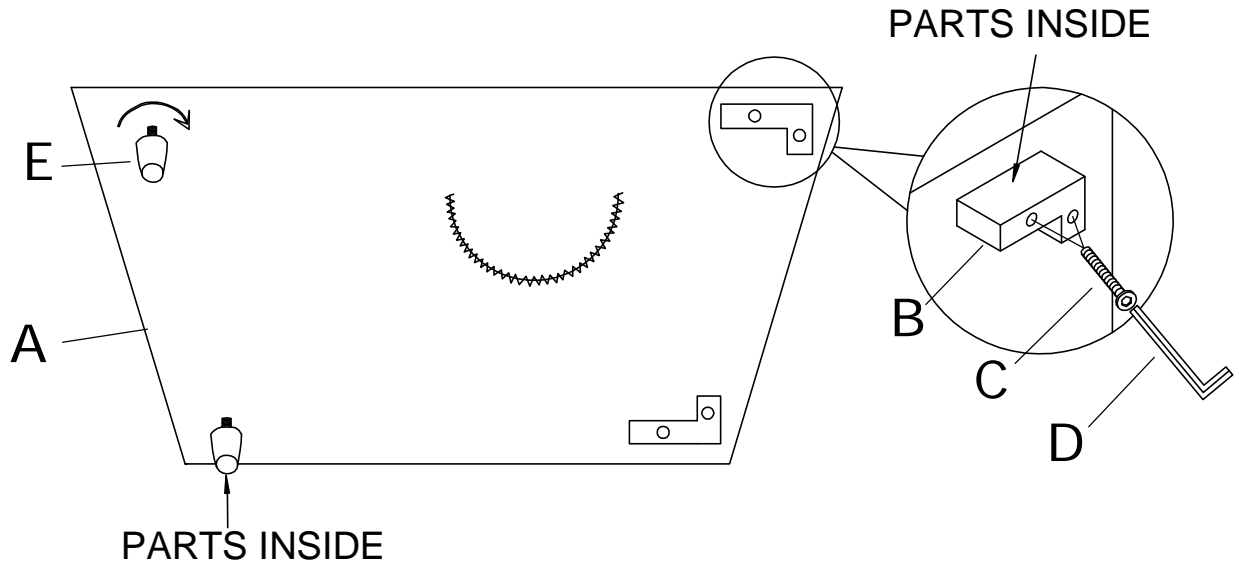

STEP # 2

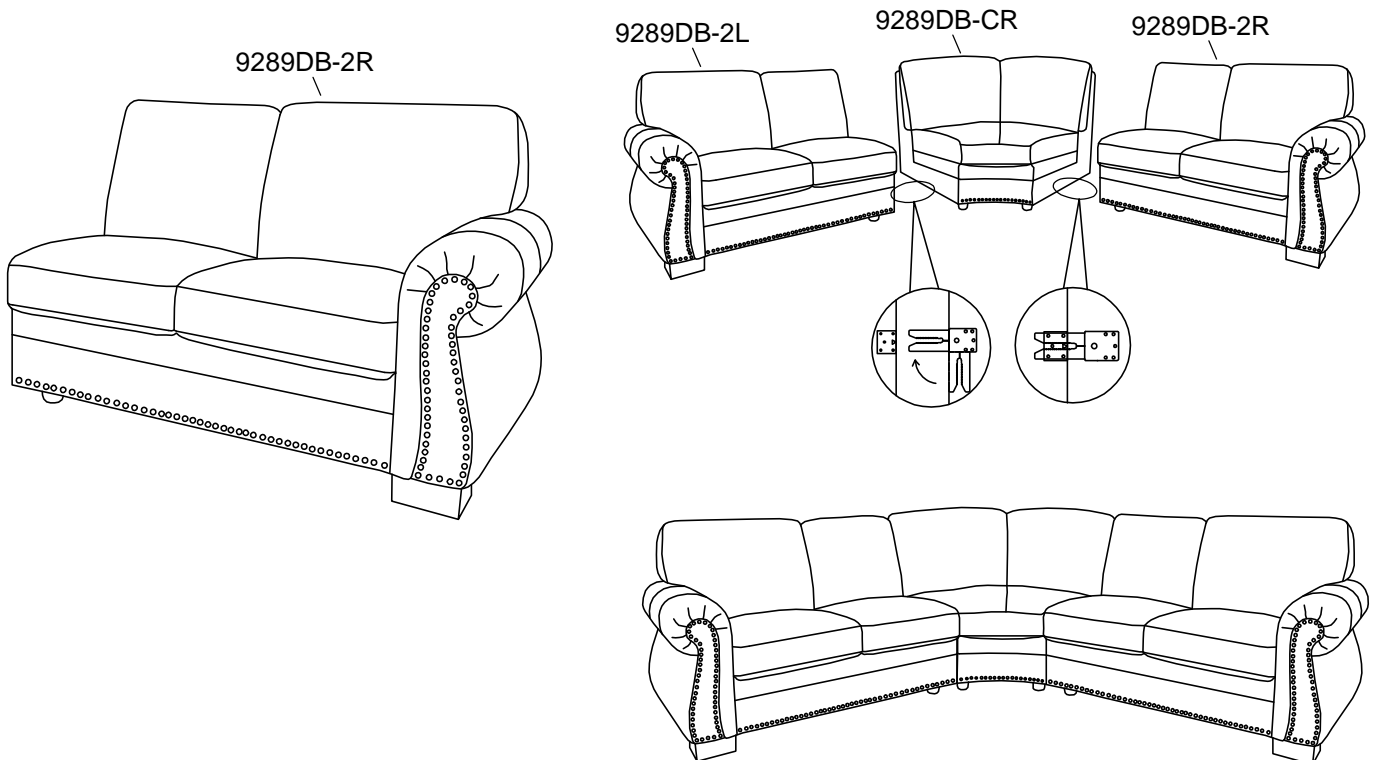

CARE INSTRUCTION FOR TOP LEATHER WITH PU FURNITURE

In order to maintain the original appearance of your furniture, please follow below care procedures .



°Avoid exposing furniture directly to sunlight or heating and air conditioning outlets. sunlight and/ or exposure to heating and air conditioning outlets will fade/damage top leather with pu. do not place your upholstered furniture too close to windows, radiators, vents and be sure to use window treatments to block the sun's rays .

°Wipe with a soft brush to remove dust.

ASSEMBLY INSTRUCTION
ITEM NO: 194S9289DB-2L
LSF 2-SEATER

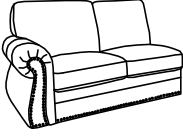
LEGS AND HARDWARE ARE STORED IN THE BOTTOM OF THE SEAT, PLEASE TAKE OUT FOR ASSEMBLY.

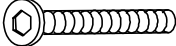
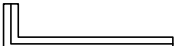
NO.	PARTS LIST	QTY	DESCRIPTION
A		1	LSF 2-SEATER

NO.	HARDWARE LIST	QTY	DESCRIPTION
B	 165*165*80mm	2	WOODEN LEGS
C	 M8*75mm	4	BOLT
D	 M5*100*38mm	1	ALLEN KEY
E	 H80mm	2	PLASTIC LEGS

ASSEMBLY INSTRUCTION
ITEM NO: 194S9289DB-2L
LSF 2-SEATER

STEP # 1

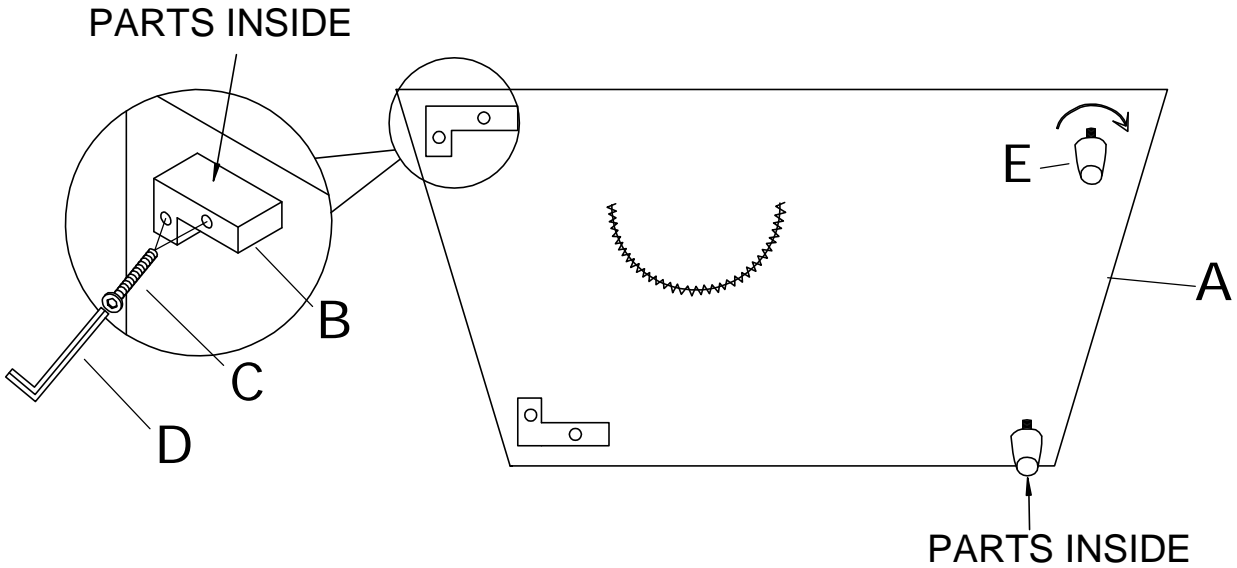

STEP # 2

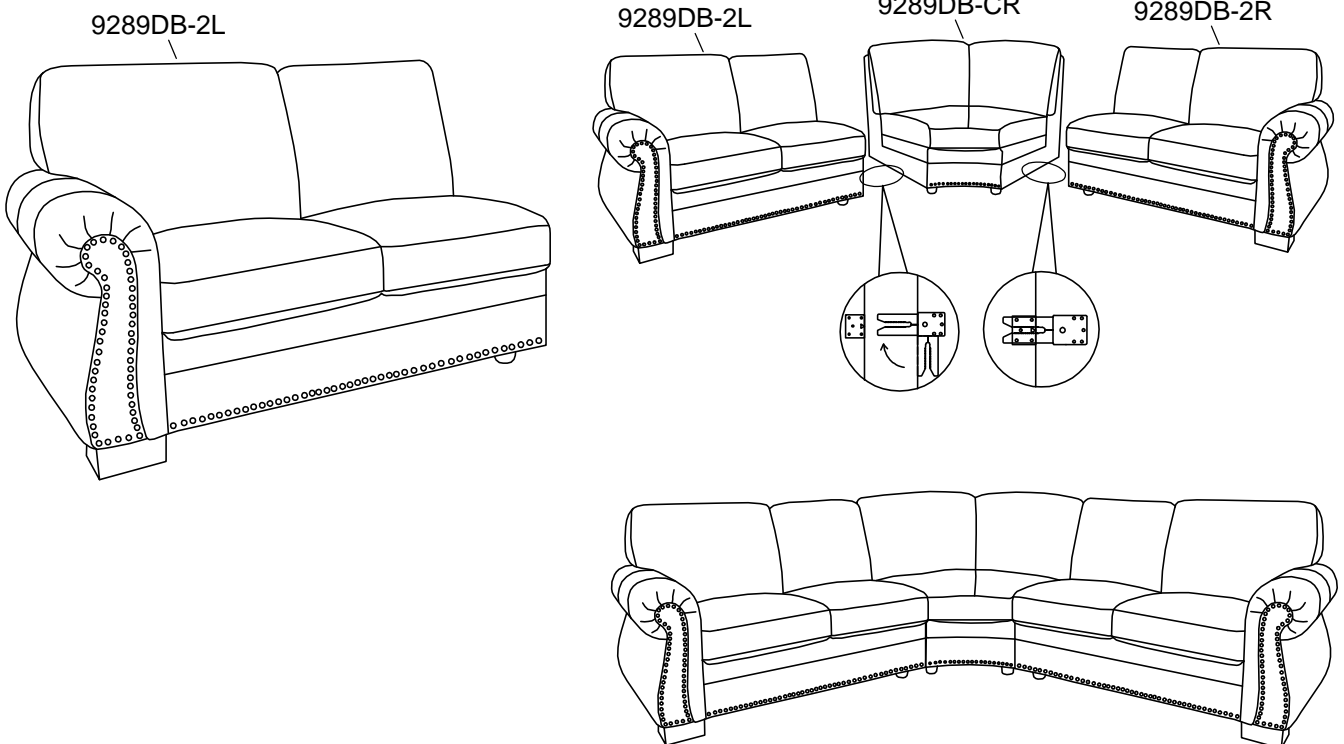

CARE INSTRUCTION FOR TOP LEATHER WITH PU FURNITURE

In order to maintain the original appearance of your furniture, please follow below care procedures .

°Avoid exposing furniture directly to sunlight or heating and air conditioning outlets. sunlight and/ or exposure to heating and air conditioning outlets will fade/damage top leather with pu. do not place your upholstered furniture too close to windows, radiators, vents and be sure to use window treatments to block the sun's rays .

°Wipe with a soft brush to remove dust.

ASSEMBLY INSTRUCTION
ITEM NO: 194S9289DB-CR
CORNER SEAT

LEGS ARE STORED IN THE BOTTOM OF THE SEAT, PLEASE TAKE OUT FOR ASSEMBLY.

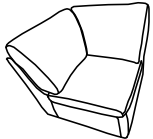
NO.	PARTS LIST	QTY	DESCRIPTION
A		1	CORNER SEAT

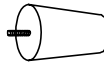
NO.	HARDWARE LIST	QTY	DESCRIPTION
B	 H80mm	5	PLASTIC LEGS

ASSEMBLY INSTRUCTION
ITEM NO: 194S9289DB-CR
CORNER SEAT

STEP # 1

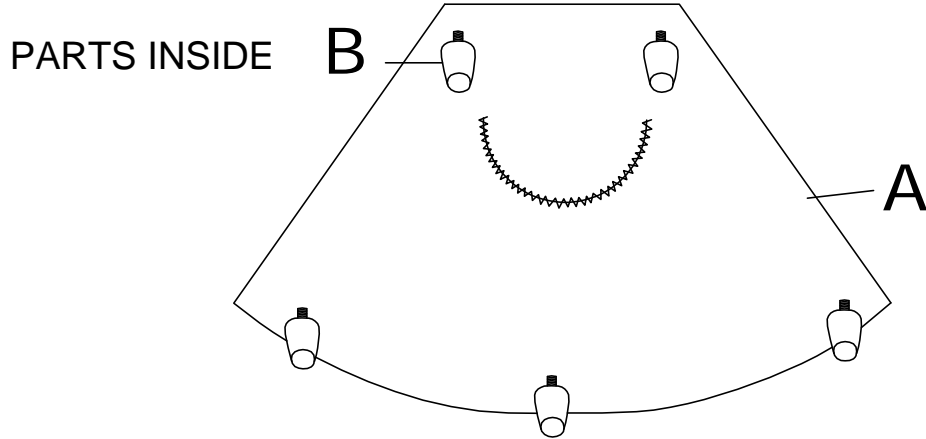

STEP # 2

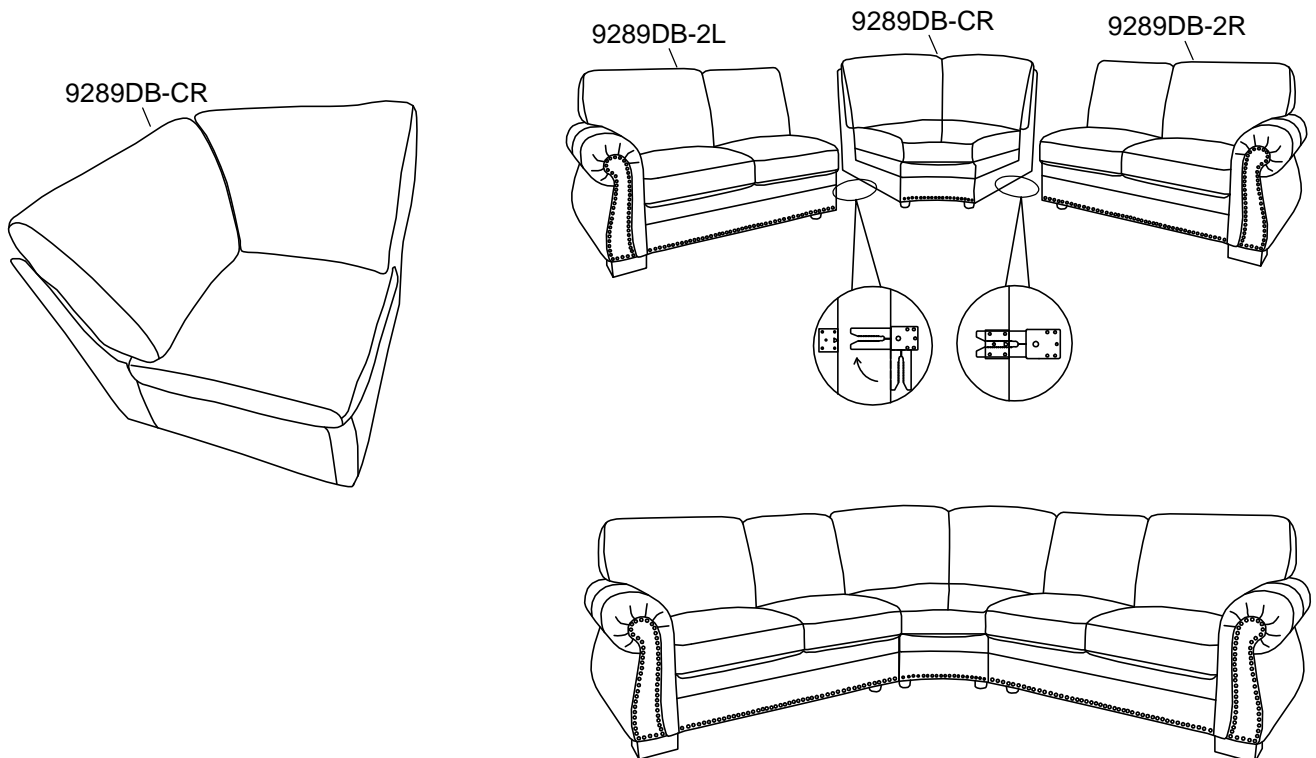

CARE INSTRUCTION FOR TOP LEATHER WITH PU FURNITURE

In order to maintain the original appearance of your furniture, please follow below care procedures .

°Avoid exposing furniture directly to sunlight or heating and air conditioning outlets. sunlight and/ or exposure to heating and air conditioning outlets will fade/damage top leather with pu. do not place your upholstered furniture too close to windows, radiators, vents and be sure to use window treatments to block the sun's rays .

°Wipe with a soft brush to remove dust.