

ASSEMBLY INSTRUCTION

194S8528DG-2L LSF Power reclining Love seat , Dark Gray

194S8528DG-2RCN RSF Power double reclining Love seat With Console, Receptacles and USB Ports, Dark Gray











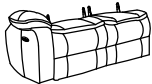

194S8528DG-CR Corner Seat, Dark Gray



Hardware are stored under the mechanism, please take out the hardware for assembly.

Note: Do not use power tools for assembly. Power tools increase the risk of over tightening which lead to splitting or cracking the wood.

Component list

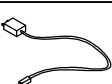
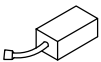
No	Drawing	Qty	Description
A		1	LSF SEAT
B		1	LSF BACK REST
C		1	RSF BACK REST
D		1	LSF WING
E		1	RSF SEAT + LSF ARM + CONSOLE
F		1	LSF BACK REST FOR (E)
G		1	CONSOLE BACK REST
H		1	RSF BACK REST FOR (E)
I		1	RSF EAR
J		1	CORNER SEAT
K		1	LSF CORNER BACK
L		1	RSF CORNER BACK
M		2	STAR KNOB
N		2	PLUG
P		2	ADAPTOR

Step #1

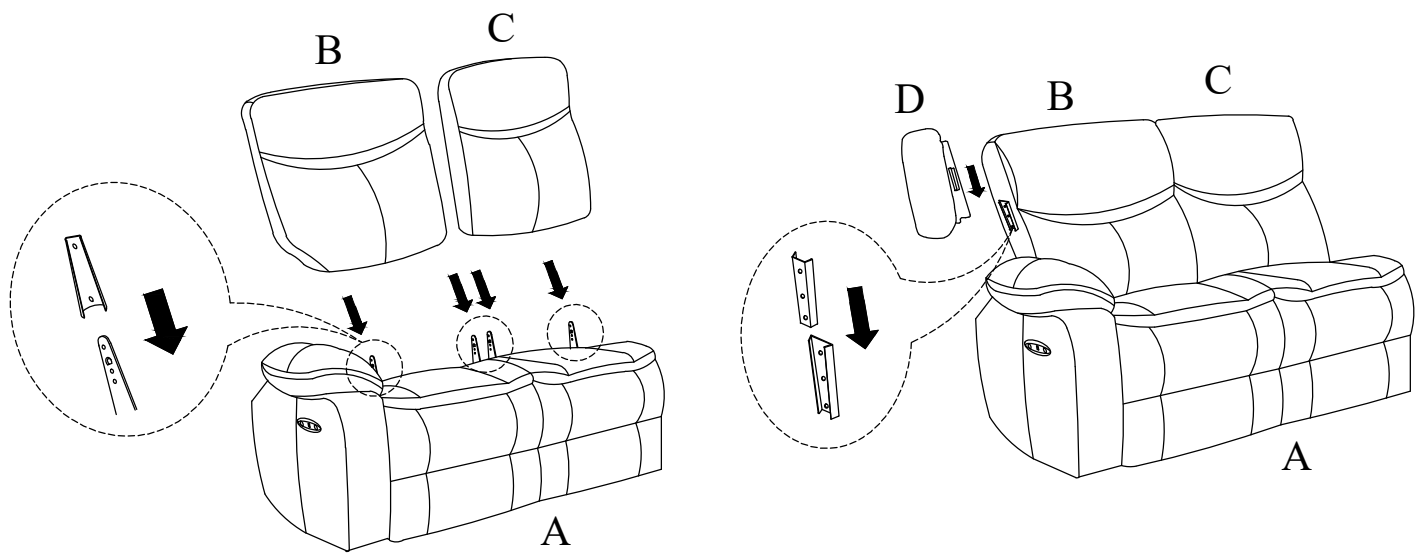

Step #2

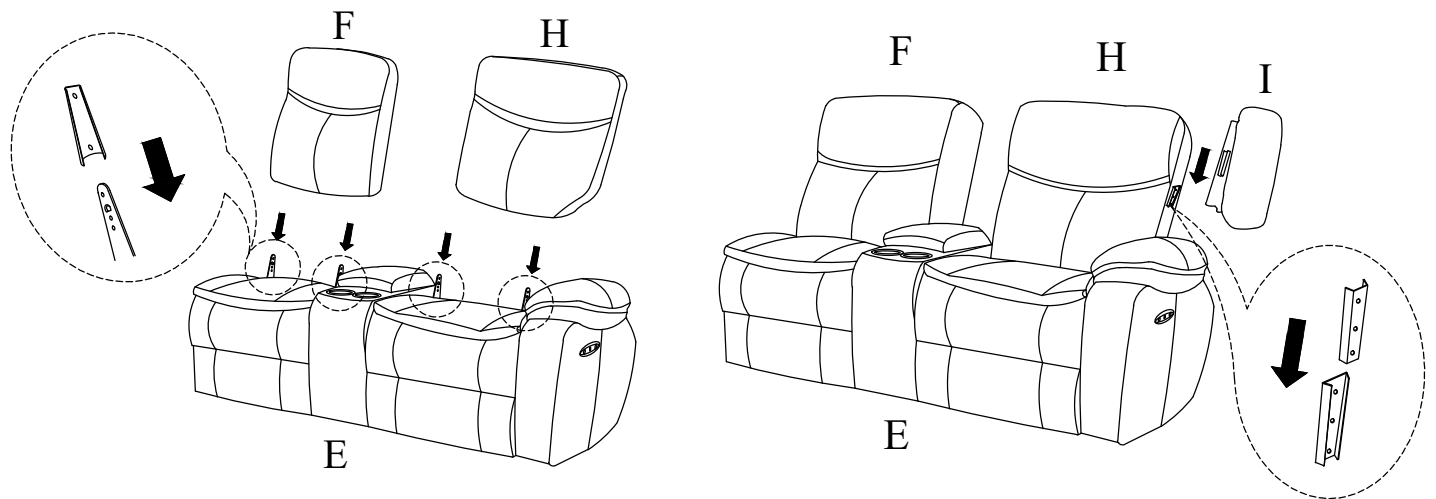

Step #3

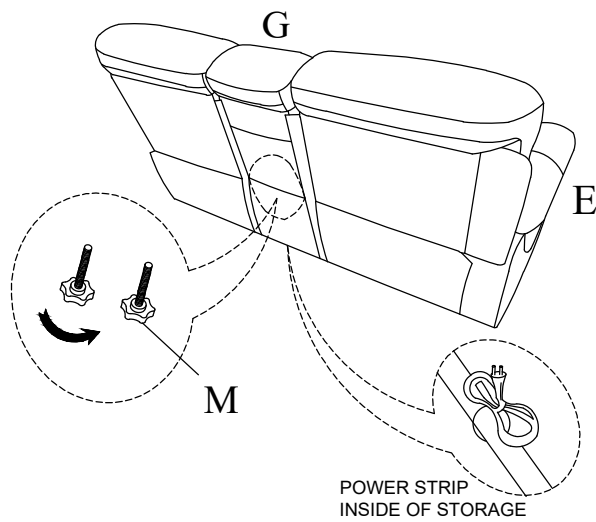

Step # 4

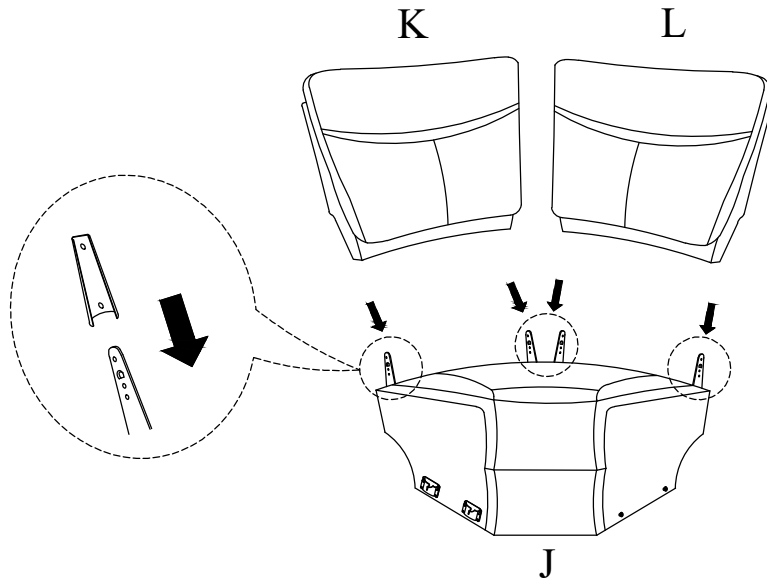

Step # 5

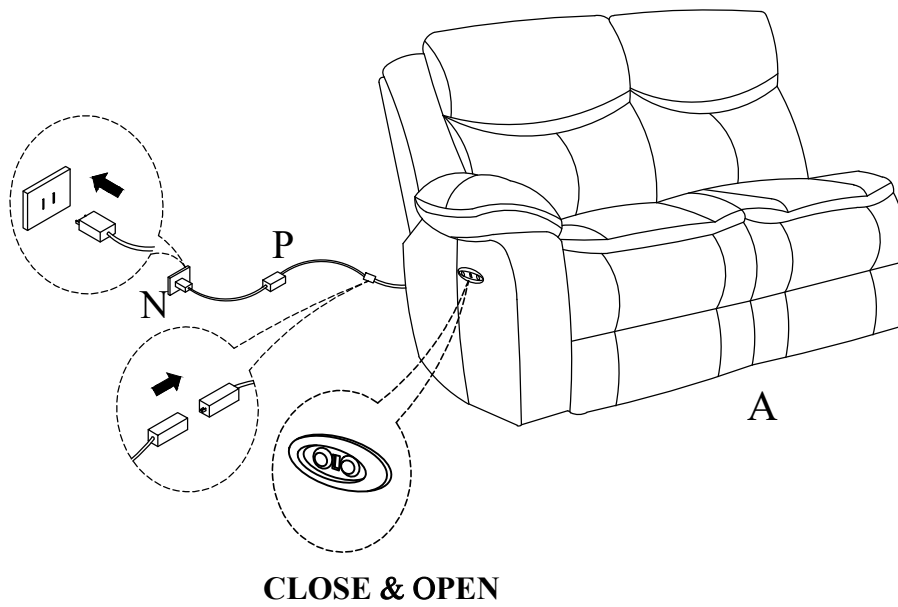

Step # 6

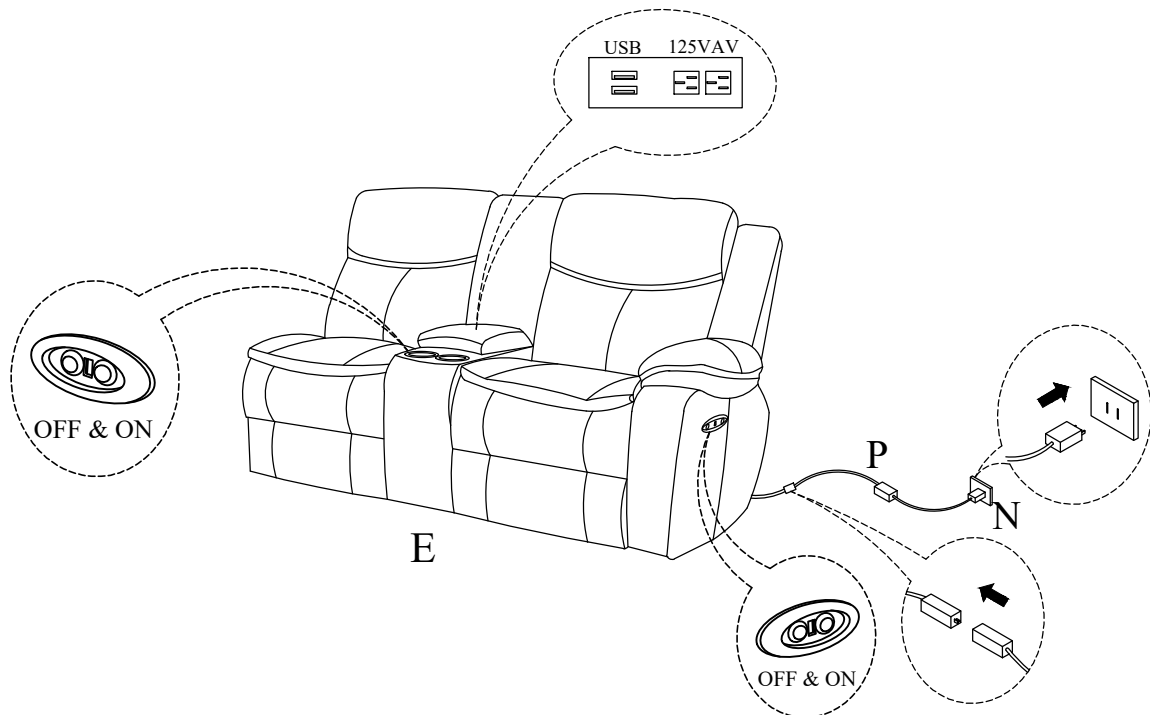

Step # 7

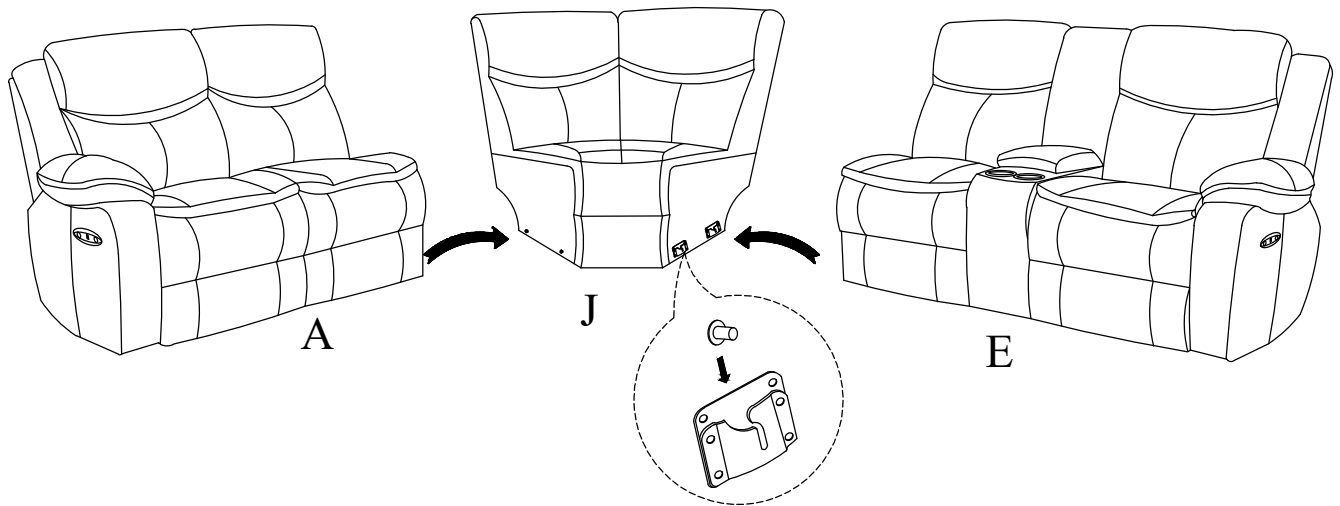

Step # 8

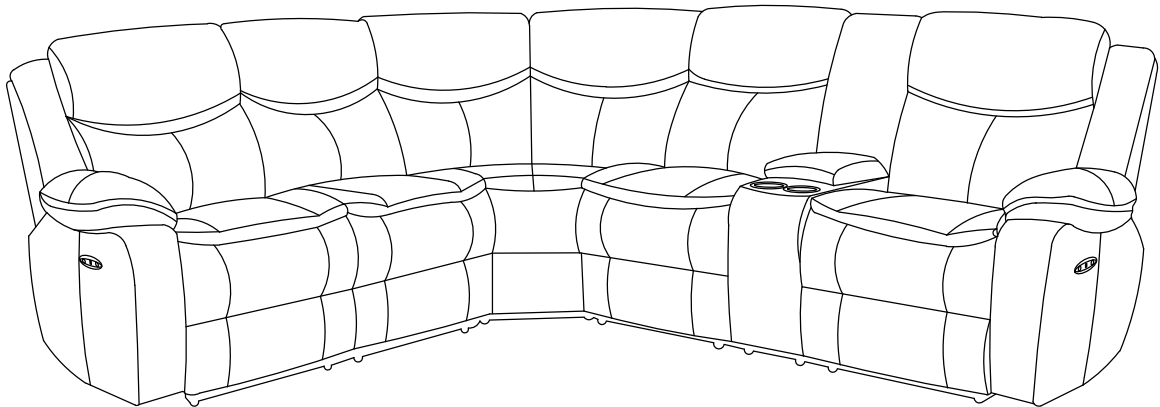

Care Instruction for Leather Air Furniture:

In order to maintain the original appearance of your leather air Furniture, please follow below simple care procedures:

- Avoid exposing furniture directly to sunlight or heating and air conditioning outlets. Sunlight and or exposure to heating and air conditioning outlets will fade/damage leather air.
- Vacuum or wipe with a soft cloth to remove dust.



For items use on wooden floor, hard surfaces or carpets, it is recommended to Install protective pads under all legs and supports to avoid/prevent from damages/scratches and discoloration.